

Anonyme. The Journal of physical chemistry. Published at Cornell university [puis Published under the auspices of the American chemical society, the Chemical society and the Faraday society]. 1896 [I]-. 1930 . Jan.-june.

1/ Les contenus accessibles sur le site Gallica sont pour la plupart des reproductions numériques d'oeuvres tombées dans le domaine public provenant des collections de la BnF. Leur réutilisation s'inscrit dans le cadre de la loi n°78-753 du 17 juillet 1978 :

\*La réutilisation non commerciale de ces contenus est libre et gratuite dans le respect de la législation en vigueur et notamment du maintien de la mention de source.

\*La réutilisation commerciale de ces contenus est payante et fait l'objet d'une licence. Est entendue par réutilisation commerciale la revente de contenus sous forme de produits élaborés ou de fourniture de service.

Cliquer [ici](#) pour accéder aux tarifs et à la licence

2/ Les contenus de Gallica sont la propriété de la BnF au sens de l'article L.2112-1 du code général de la propriété des personnes publiques.

3/ Quelques contenus sont soumis à un régime de réutilisation particulier. Il s'agit :

\*des reproductions de documents protégés par un droit d'auteur appartenant à un tiers. Ces documents ne peuvent être réutilisés sauf dans le cadre de la copie privée sans l'autorisation préalable du titulaire des droits.

\*des reproductions de documents conservés dans les bibliothèques ou autres institutions partenaires. Ceux-ci sont signalés par la mention Source Gallica.BnF.fr / Bibliothèque municipale de ... (ou autre partenaire). L'utilisateur est invité à s'informer auprès de ces bibliothèques de leurs conditions de réutilisation.

4/ Gallica constitue une base de données, dont la BnF est producteur, protégée au sens des articles L341-1 et suivants du code la propriété intellectuelle.

5/ Les présentes conditions d'utilisation des contenus de Gallica sont régies par la loi française. En cas de réutilisation prévue par un autre pays, il appartient à chaque utilisateur de vérifier la conformité de son projet avec le droit de ce pays.

6/ L'utilisateur s'engage à respecter les présentes conditions d'utilisation ainsi que la législation en vigueur, notamment en matière de propriété intellectuelle. En cas de non respect de ces dispositions, il est notamment passible d'une amende prévue par la loi du 17 juillet 1978.

7/ Pour obtenir un document de Gallica en haute définition, contacter [reutilisation@bnf.fr](mailto:reutilisation@bnf.fr).

***Journal of physical  
chemistry***

**Tome 34**

**Volume 35**

***Washington* 1930**

Cy

**ANNULÉ**

CPg4

# The Journal of Physical Chemistry

Published under the auspices of the American Chemical  
Society, the Chemical Society and the Faraday Society

*Editor*

Wilder D. Bancroft

*Associate Editors*

A. J. Allmand  
F. G. Donnan  
R. A. Gortner  
James Kendall

T. S. Price  
C. A. Kraus  
J. W. McBain  
E. K. Rideal



VOLUME XXXIV  
JANUARY-JUNE

ITHACA, N. Y.  
THE EDITOR

1930



CONTENTS OF VOLUME XXXIV

1. JANUARY

<i>Wilder D. Bancroft</i> <i>and G. E. Cunningham,</i> <i>P. H. Emmett</i> <i>and Katharine S. Love,</i>	Iron Oxide in Borate Beads,.....	1
	A Comparison of the Catalytic and Chemical Characteristics of Cubic and Rhombohedral Ferric Oxide,.....	41
<i>H. H. Lowry,</i> <i>A. Frumkin</i> <i>and F. J. Cirves,</i> <i>H. B. Weiser and G. L. Mack,</i> <i>H. B. Weiser and G. L. Mack,</i> <i>S. Roy and N. R. Dhar,</i>	On the Nature of Active Carbon,.....	63
	Electrocapillary Properties of Amalgams,.....	74
	The Formation of Lyophobic Organosols,.....	86
	Stability of Lyophobic Organosols,.....	101
	Influence of Light on the Coagulation, Electrical Conductivity, and the Absorption Spectra of Some Colloids,.....	122
<i>Helen Q. Woodard,</i>	A Comparison of Silver and Lead Sols made by the Bredig Method,.....	138
<i>S. Venkateswaran,</i> <i>A. K. Brewer</i> <i>and J. W. Westhaver,</i> <i>J. G. McNally</i> <i>and S. E. Sheppard,</i> <i>T. R. Briggs</i> <i>and W. S. Benedict,</i> <i>S. H. Carsley,</i>	On the Raman Effect in Liquid Pyridine,.....	145
	Further Investigations on the Synthesis of Ammonia in the Glow Discharge,.....	153
	Double Refraction in Cellulose Acetate and Nitrate Films,.....	165
<i>F. C. Kracek</i> <i>and R. E. Gibson,</i> <i>Preston Robinson,</i> <i>Mary Kilpatrick</i> <i>and Martin Kilpatrick,</i> <i>H. D. Crockford</i> <i>and F. W. Zurburg,</i> <i>New Books,</i>	Germanium. XXXII,.....	173
	The Reduction of Alkali Nitrates by Hydrous Ferrous Oxide,.....	178
	The Polymorphism of Sodium Sulphate. III,.....	188
	A Rule for the Mechanism of Reactions,.....	207
	Note on the Dissociation Constants of Certain Sulphonphthalein Indicators,.....	211
	Binary Systems of Certain Nitrotoluenes with Salicylic Acid,.....	214
		217

2. FEBRUARY

<i>F. C. Kracek,</i> <i>R. K. Schofield</i> <i>and G. W. Scott Blair,</i> <i>A. S. C. Lawrence,</i> <i>S. E. Sheppard</i> <i>and R. C. Houck,</i> <i>R. M. Woodman</i> <i>and E. McKenzie Taylor,</i>	The Polymorphism of Potassium Nitrate,.....	225
	The Influence of the Proximity of a Solid Wall on the Consistency of Viscous and Plastic Materials,....	248
	Soap Films and Colloidal Behavior,.....	263
	The Structure of Gelatin Sols and Gels. I,.....	273
	The Emulsifying Powers of Bentonite and Allied Clays derived from these by Base Exchange and by Hydrolysis,.....	299
<i>M. N. Chakravarti,</i> <i>S. Ghosh and N. R. Dhar,</i> <i>Harry B. Weiser,</i> <i>R. C. Ray</i> <i>and P. B. Ganguly,</i> <i>J. H. Walton</i> <i>and H. M. Stark</i> <i>P. E. Roller,</i>	Determination of a Charge on a Colloid and the Mechanism of its Coagulation,.....	326
	Adsorption and the Permeability of Membranes. I, The Optimum Conditions for the Formation of Silica Gels from Alkali Silicate Solutions,.....	335
		352
	Studies on Phosphoric Acid. I,.....	359
	The Application of the Quinhydrone Electrode to Solutions of Phenol and Cresols,.....	367

<i>H. V. Tartar, R. E. Lothrop and R. E. Pettengill, V. E. Wallman and H. V. Tartar, Gene Spencer,</i>	The Effect of Some Electrolytes on the Inversion of Emulsions,.....	373
	A Study of Factors controlling Type of Water-Soap-Oil Emulsions,.....	379
	The Relation between Acids and Pectin in Jelly Formation,.....	410
<i>B. C. Hendricks, J. H. Dorsey, R. LeRoy and A. G. Moseley, Jr., S. C. Horning,</i>	A Modified Vacuum-Walled Adiabatic Calorimeter, Velocity of a Bimolecular Reaction in a Homogeneous System,.....	418
<i>Gene Spencer, New Books,</i>	The Purification and Estimation of Pectin,.....	429
		435
	3. MARCH	
<i>Wilder D. Bancroft and C. E. Barnett, F. C. Kracek,</i>	Phase Rule Studies on the Proteins. I,.....	449
	Vapor Pressures of Solutions and the Ramsay-Young Rule,.....	499
<i>R. H. Aborn and R. L. Davison, A. F. Scott and Edward J. Durham, L. F. Audrieth,</i>	An X-Ray Investigation of the Structure of Copper-Zinc Oxide Catalysts,.....	522
	The Solubility of Soluble Electrolytes. II,.....	531
	Parallelism in the Decomposition of Ammonium, Hydrazine, and Hydroxylammonium Nitrites....	538
<i>J. H. Walton and R. J. Kepfer, N. R. Dhar,</i>	Studies on Phosphoric Acid. II,.....	543
	Influence of Ageing on Inorganic Hydrophile Colloids, Cells and Colloids in the Animal Body,....	549
<i>J. W. Westhaver and A. K. Brewer, F. E. Jones, W. E. Hamer, C.W. Davies and C.R. Bury, A. J. Hopkins and R. A. Beebe, J. W. McBain and Yasota Kawakami,</i>	Chemical Action in the Glow Discharge. III,.....	554
	Beryllium Salicylate,.....	563
	An Electrometric Study of the Precipitation of Copper Ions by Alkalies,.....	570
	The Influence of Physical State of a Soap Solution upon the Rate of Saponification of Triglycerides and the Differing Degrees of Emulsification for Neighboring Triglycerides,.....	580
<i>H. P. Munger, M. Darrin and G. Stegeman, E. O. Wittig,</i>	The Phase Diagram for the System Sulphur-Naphthalene and its Relation to Introfaction,...	593
	Temperature Coefficients of the Decomposition of Acetone Dicarboxylic Acid in Water,.....	596
<i>E. J. Murphy and H. H. Lowry, B. Bruzs, K. C. D. Hickman, K. C. D. Hickman and C. R. Sanford, Gene Spencer, P. J. R. Butler,</i>	The Complex Nature of Dielectric Absorption and Dielectric Loss,.....	598
	The Surface Energy of Solids. I,.....	621
	A Low-Pressure Tensimeter,.....	627
	The Purification, Properties, and Uses of Certain High-Boiling Organic Liquids,.....	637
	Manipulation of Jelly Strength-Testing Apparatus,.....	654
	The Influence of Temperature upon Rapid Coagulation of Gold Hydrosol,.....	656
<i>Ashutosh Ganguli, H. C. Ramsperger,</i>	On the Adsorption of Gases by Solids,.....	665
	The Effect of Ethane and Nitrogen on the Rate of Thermal Decomposition of Azomethane at Low Pressures,.....	669
<i>New Books,</i>		672

	4. APRIL	
<i>Grinnell Jones,</i>	On the Existence and Behavior of Complex Polyiodides,.....	673
<i>F. K. Cameron,</i>	The Solubility of Ferrous Sulphate,.....	692
<i>C. C. Palit</i>	Slow and Induced Oxidation of Glycogen, Lecithin, Cholesterol, Formate, Oleate, Stearate, and Some Food Materials,.....	711
<i>and N. R. Dhar,</i>		
<i>M. E. Lash</i>	Adsorption at Crystal-Solution Interfaces,.....	724
<i>and W. G. France,</i>	Comparative Influence of Sunlight, Iron Preparations, and Vitamins in the Maintenance of Health,	737
<i>C. C. Palit, R. K. Kaul</i>		
<i>and N. R. Dhar,</i>	The Vapor Pressure of Some Stannanes,.....	743
<i>R. H. Bullard</i>		
<i>and A. C. Haussmann,</i>	Platinum Black Catalysts. I,.....	748
<i>G. B. Taylor,</i>	Phase Rule Studies on Proteins. II,.....	753
<i>G. B. Kistiakowsky</i>		
<i>and J. H. Perry,</i>	Platinum Black Catalysts. II,.....	799
<i>Wilder D. Bancroft</i>	The Origin of the Chemical Elements,.....	821
<i>and C. E. Barnett,</i>		
<i>G. B. Taylor,</i>	Rhythmic Evaporation Rings of Orange II and Fast Red B,.....	842
<i>G. B. Kistiakowsky</i>	Active Glucose,.....	855
<i>and J. H. Perry,</i>	The Electromotive Force of Zinc Amalgams,.....	863
<i>S. B. Stone,</i>	The Heat of Adsorption of Carbon Dioxide on Charcoal calculated by means of Polanyi's Theory of Adsorption,.....	870
<i>E. C. H. Davies,</i>	A Study of the Influence of Hydrolysis Temperature on Some Properties of Colloidal Ferric Oxide. I,	875
<i>Kenneth Taylor</i>	Note on the Calibration of Conductivity Apparatus,	885
<i>and E. W. Riblett,</i>		887
<i>C. E. Clifton and J. M. Ort,</i>		
<i>J. L. Crenshaw,</i>		
<i>J. K. Dixon,</i>		
<i>G. H. Ayers</i>		
<i>and C. H. Sorum,</i>		
<i>I. W. Wark,</i>		
<i>New Books,</i>		
<i>Wilder D. Bancroft</i>	5. MAY	
<i>and H. L. Davis,</i>	The Optical Rotation of Malic Acid.....	897
<i>Robert Taft</i>	The Electrodeposition of Metals from their Liquid Ammonia Solutions,.....	929
<i>and Harold Barham,</i>	Influence of Temperature on the Coagulation of Sols, and the Problem of the Acclimatization of Animals,.....	954
<i>N. R. Dhar</i>		
<i>and Satya Prakash,</i>		
<i>M. G. Mellon</i>	Solutions for Colorimetric Standards. III,.....	963
<i>and Violet Foster,</i>	The Nature of Isoelectric Gelatin in Solution. I,...	973
<i>A. E. Stern,</i>	The Nature of Isoelectric Gelatin in Solution. II,...	981
<i>A. E. Stern,</i>	Photochemical Oxidation of Salts of Some Organic Acids, Lecithin, Cholesterol, and Some Food Materials by Air,.....	993
<i>C. C. Palit</i>	Calorimetric Researches. III,.....	1006
<i>and N. R. Dhar,</i>		
<i>L. J. P. Keffler,</i>	The Dissociation of Strong Electrolytes. I,.....	1013
<i>M. B. Jacobs</i>	The Color of Arsenic Trisulphide,.....	1021
<i>and C. V. King,</i>	Comparative Measurements of the Surface Conductivity of Solutions of Various Electrolytes at a Boundary of Pyrex,.....	1033
<i>H. B. Weiser,</i>		
<i>J. W. McBain</i>		
<i>and C. R. Peaker,</i>		

<i>S. E. Sheppard,</i>	The Dispersion of Cellulose and Cellulose Derivatives	1041
<i>Hans Jenny,</i>	An Equation of State for Soil Nitrogen,.....	1053
<i>B. A. Starrs</i>	The System: Potassium Sulphate, Magnesium	
<i>and L. Clarke,</i>	Sulphate, Water,.....	1058
<i>H. D. Crockford</i>		
<i>and L. E. Warrick,</i>	The System: $\text{CuSO}_4\text{-H}_2\text{SO}_4\text{-H}_2\text{O}$ ,.....	1064
<i>W. M. Sandstrom,</i>	Physico-chemical Studies on Proteins. IV,.....	1071
<i>P. H. Emmett</i>	The Effect of X-Radiation on a Platinum Catalyst	
<i>and E. J. Jones,</i>	in the Synthesis of Water,.....	1102
<i>Beatrice R. Deacon,</i>	The Effect of Temperature on the Stability of Copper	
	Colloidal Solutions,.....	1105
<i>H. G. Tanner,</i>	An Improved Pirani Gage,.....	1113
<i>New Books,</i>		1116
6. JUNE		
<i>W. P. White,</i>	Calorimetry in Furnaces,.....	1121
<i>A. N. C. Bennett,</i>	Research on Nitrous Oxide,.....	1137
<i>S. E. Sheppard</i>	The Sorption of Water Vapor by Cellulose and	
<i>and P. T. Newsome,</i>	Derivatives. II,.....	1158
<i>L. S. Kassel,</i>	The Homogeneous Decomposition of Gaseous	
	Acetaldehyde,.....	1166
<i>Dean Burk,</i>	The Influence of Nitrogen Gas upon the Organic	
	Catalysis of Nitrogen Fixation by Azotobacter,	1174
<i>Dean Burk,</i>	The Influence of Oxygen Gas upon the Organic	
	Catalysis of Nitrogen Fixation by Azotobacter,	1195
<i>W. C. Johnson</i>	The Preparation of Gallium Tribromide and Gallium	
<i>and J. B. Parsons,</i>	Triiodide,.....	1210
<i>A. W. Davidson,</i>	A Solid Addition Compound of Acetic Acid and	
	Stannic Chloride,.....	1215
<i>Wilder D. Bancroft</i>	Phase Rule Studies on the Proteins. III,.....	1217
<i>and C. E. Barnett,</i>	An Automatic Thermoregulator,.....	1254
<i>J. A. Beattie</i>	The Adsorption of Vapors of Methane and its	
<i>and D. B. Jacobus,</i>	Chlorine Derivatives by Activated Charcoal,..	1260
<i>J. N. Pearce</i>	Chemical Action in the Glow Discharge. IV,.....	1280
<i>and H. F. Johnstone,</i>	A Vacuum-Tube Potentiometer for the Determina-	
<i>A. K. Brewer</i>	tion of the True E.M.F. of a High-Resistance Cell,	1294
<i>and J. W. Westhaver,</i>		
<i>R. J. Fosbinder,</i>	The Dissociation of Strong Electrolytes. II,.....	1303
<i>M. B. Jacobs</i>	The Determination of Vapor and Liquid Composi-	
<i>and C. V. King,</i>	tions in Binary Systems,.....	1310
<i>W. G. Beare, G. A. McVicar</i>	Calorimetric Researches on Geometric Isomerisms, .	1319
<i>and J. B. Ferguson,</i>	Cataphoretic Measurements and the Theory of the	
<i>L. J. P. Keffler,</i>	Critical Potential,.....	1326
<i>D. R. Briggs,</i>		1353
<i>New Books,</i>		
7. JULY		
<i>G. I. Hoover, K. W. Huntten</i>	Electrical Conductivity Studies of the Interaction of	
<i>and C. A. Sankey,</i>	Sulphurous Acid and Certain Aldehydes,.....	1361
<i>J. H. Hibben,</i>	Experimental Procedure and the Kinetics of the	
	Nitrogen Pentoxide Decomposition at Low	
	Pressures,.....	1387
<i>H. J. Osterhof</i>	Three Fundamental Types of Wetting. Adhesion	
<i>and F. E. Bartell,</i>	Tension as the Measure of the Degree of Wetting,	1399



<i>E. W. Bird</i> and <i>R. M. Hizon</i> , <i>A. F. Scott</i> and <i>E. J. Durham</i> , <i>J. W. McBain</i> , <i>D. N. Jackman</i> , <i>A. M. Baker</i> and <i>H. G. Smith</i> , <i>F. H. Getman</i> , <i>I. M. Kolthoff</i> , <i>H. L. Ward</i> and <i>S. S. Cooper</i> , <i>W. I. Patnode</i> and <i>Jacob Papish</i> , <i>C. E. Barnett</i> , <i>G. W. Scott Blair</i> ,	Measurements with Sodium and Potassium Amalgam Electrodes,.....	1412
	Studies in the Solubilities of the Soluble Electro- lytes. III,.....	1424
	The Sorption of Organic Vapors by Activated Sugar Charcoal,.....	1439
	A Study of the Potential of the Copper Electrode, Indicator Constants,.....	1454 1466
	The System Benzoic Acid, Orthophthalic Acid, Water,	1484
	The Vapor Pressure of Silicon Tetrafluoride,.....	1494
	Melamine,.....	1497
	A Further Study of the Influence of the Proximity of a Solid Wall on the Consistency of Viscous and Plastic Materials,.....	1505
<i>W. M. Martin</i> and <i>R. A. Gortner</i> , <i>E. A. Guggenheim</i> ,	Studies on Electrokinetic Potentials,.....	1509
	On the Conception of Electrical Potential Difference between two Phases. II,.....	1540
<i>R. T. Dufford</i> , <i>H. W. Morse</i> , <i>J. L. R. Morgan</i> and <i>H. R. Pyne</i> , <i>F. C. Kracek</i> , <i>E. W. Madge</i> ,	Photo-voltaic Effects in Grignard Solutions,.....	1544
	Periodic Precipitation in Ordinary Aqueous Solutions,	1554
	Solubility-Relations in Gas-Liquid Systems. I,....	1578
	The System Sodium Oxide-Silica,.....	1583
	The Variation of the Viscosity of Liquids with the Temperature,.....	1599
<i>Julius Sendroy, Jr.</i> and <i>A. B. Hastings</i> , New Books,	Reply to Note on the Dissociation Constants of Certain Sulphonphthalein Indicators,.....	1607 1609
8. AUGUST		
<i>G. Egloff</i> , <i>R. E. Schaad</i> and <i>C. D. Lowry, Jr.</i> , <i>F. C. Kracek</i> , and <i>C. J. Kaanda</i> , <i>G. W. Morey</i> , <i>E. A. Guggenheim</i> ,	The Decomposition of the Paraffin Hydrocarbons,..	1617
	The Polymorphism of Sodium Sulphate. IV,.....	1741
	Analytical Methods in Phase Rule Problems,.....	1745
	On the Laws of Dilute Solutions and of Perfect Solutions,.....	1751
<i>E. A. Guggenheim</i> , <i>Wilder D. Bancroft</i> and <i>J. W. Ackerman</i> , <i>L. S. Kassel</i> , <i>Wilder D. Bancroft</i> and <i>H. L. Davis</i> , <i>R. J. Best</i> ,	Studies of Cells with Liquid-Liquid Junctions. II,	1758
	A Study of a Methyl-Violet Lake,.....	1767
	The Theory of Third-Order Gas Reactions,.....	1777
	The Influence of Substituents on Indicators,.....	1797
	The Application of the Quinhydrone Electrode to the Measurement of Acid Reaction of unbuffered Solutions,.....	1815
<i>J. L. R. Morgan</i> and <i>H. R. Payne</i> , <i>D. D. Peirce</i> and <i>L. F. Yntema</i> ,	Solubility Relations in Gas-Liquid Systems. II,..	1818
	Electrometric Studies of the Precipitation of Colum- bium and Tantalum and of Molybdenum and Tungsten,.....	1822
<i>H. B. Weiser</i> , <i>A. E. Collett</i> and <i>C. L. Lazzell</i> ,	Adsorption and the Permeability of Membranes. II,	1826
	Solubility Relations of the Isomeric Nitrobenzoic Acids. II,.....	1838

<i>E. W. R. Steacie, Stephen Popoff and E. W. Neuman,</i>	The Rate of Coagulation of Silver Hydrosol,.....	1848
<i>Andreas Smits, S. T. Bowden,</i>	Solubility of Inorganic Precipitates in Various Aqueous Solvents and its Relations to Modern Theories of Solution,.....	1853
<i>New Books,</i>	The Intensive Drying of Liquids,.....	1861
	The Double-Capillary Method of Surface Tension Measurement,.....	1866 1869
9. SEPTEMBER		
<i>B. W. Nordlander, L. F. Audrieth and L. F. Yntema,</i>	The Kinetics of the Vulcanization of Rubber,.....	1873
<i>E. W. Florsdorf and G. B. Kistiakowsky, W. C. Schumb and Herschel Hunt, G. L. Clark, V. R. Hardy and H. B. Willman, Wilder D. Bancroft, and C. E. Barnett, J. L. Shereshefsky,</i>	Preliminary Study of the Electrodeposition of Metals from Liquid Ammonia Solutions of their Salts,.....	1903
<i>T. R. Briggs, J. A. Greenawald and J. W. Leonard, D. B. Hand, G. Fuseya and K. Murata, G. Fuseya, K. Sasaki and M. Nagano, G. S. Parks, S. B. Thomas and W. A. Gilkey, A. F. Scott and E. J. Durham, J. L. R. Morgan and H. R. Pyne, H. S. Taylor, W. L. Huff and J. A. Wilkinson, E. W. R. Steacie and G. B. Graham, K. L. Malhotra and H. D. Suri,</i>	Heats of Adsorption on Catalytically Active Sur- faces,.....	1907
<i>Robert Rieder, H. D. Crockford and A. E. Hughes, Robert Livingston, Wilder D. Bancroft and B. C. Belden, New Books,</i>	Chemical Reactions induced by the Electrodeless Discharge,.....	1919
	Ultra-violet Spectroscopy of the Flames of Motor Fuels,.....	1924
	Phase Rule Studies on the Proteins. IV,.....	1930
	The Corresponding State of Maximum Surface Ten- sion of Saturated Vapors,.....	1947
	The Polyiodides of Cesium—Cesium Iodide, Iodine, and Water at 25°,.....	1951
	Dimeric Distribution,.....	1961
	Formation of Complex Cations of Metal Ions with Glycocoll,.....	2001
	Viscosities of Dilute Solutions of Ash-free Gelatin,	2013
	Studies on Glass. V,.....	2028
	Studies in the Solubilities of the Soluble Electro- lytes. IV,.....	2035
	Solubility Relations in Gas-Liquid Systems. III,...	2045
	Second Report of the Committee on Photochemistry,	2049
	Base Exchange between Dyes and Soils,.....	2092
	The Solubility of Water Vapor in Solid Inorganic Compounds at High Temperatures,	2098
	Equilibrium in the Systems: Potassium Sulphate- Cadmium Sulphate-Water and Ammonium Sulphate-Cadmium Sulphate-Water at 25°C,..	2103
	The Velocity of the Iodate-Thiosulphate Reaction,..	2111
	Binary Systems of Certain Nitrotoluenes with Ben- zoic Acid,.....	2117
	The Halogen-sensitized Oxidation of Carbon Monox- ide,.....	2121
	Aniline and Hydrogen Sulphide,.....	2123 2125

## 10. OCTOBER

<i>J. C. W. Fraser,</i>	Eighth Report of the Committee on Contact Catalysis,.....	2129
<i>Martin Kilpatrick, Jr. and J. H. Rushton, S. E. Sheppard and R. C. Houck, L. J. Burrage,</i>	The Rate of Solution of Magnesium in Acids,.....	2180
	The Structure of Gelatin Sols and Gels. III,.....	2187
	A New Method for the Determination of Sorption Isotherms of Vapors on Charcoal,.....	2202
<i>I. B. Johns, W. D. Peterson and R. M. Hixon, I. B. Johns and R. M. Hixon, F. G. Foote, F. C. Blake and W. G. France, E. J. Salstrom and G. McP. Smith,</i>	Electron-sharing Ability of Organic Radicals. I,...	2218
	Electron-sharing Ability of Organic Radicals. II,...	2226
	Adsorption at Crystal-Solution Interfaces,.....	2236
	The Reciprocal Influence of the Presence of Sodium Sulphate and of Potassium Sulphate on the Solubilities of each other in Water,.....	2241
<i>T. R. Briggs and W. F. Geigle, T. R. Briggs, J. F. Chittum, J. A. V. Butler and Charles Ockrent, Charles Ockrent and J. A. V. Butler, Robert Taft and Jesse Stareck, W. J. Jenkins and H. B. Bennett, L. Rubenstein, A. K. Brewer and J. W. Westhaver, J. L. R. Morgan and A. H. Richardson, B. A. Starrs and H. H. Storch, H. D. Crockford and M. W. Webster, New Books,</i>	Iodine and Potassium Iodide,.....	2250
	The Polyiodides of Cesium. II,.....	2260
	The Electrochemical Behavior of Metals. I,.....	2267
	Studies in Electrocapillarity. I,.....	2286
	Studies in Electrocapillarity. II,.....	2297
	Relationship between Melting-Points, Normal Boiling-Points and Critical Temperatures,.....	2307
	Sorption Experiments with Cellulose Nitrate. I,...	2318
	Sorption Experiments with Cellulose Nitrate. II,...	2330
	Chemical Action in the Glow Discharge. V,.....	2343
	Solubility Relations in Gas-Liquid Systems. IV,...	2356
	The Ternary System: Potassium Sulphate-Magnesium Sulphate-Water,.....	2367
	The System: Copper Sulphate-Lithium Sulphate-Water,.....	2375
		2378

## 11. NOVEMBER

<i>S. O. Morgan and H. H. Lowry, Wilder D. Bancroft and C. E. Barnett, E. C. Truesdale,</i>	Dielectric Polarization of Some Pure Organic Compounds in the Dissolved, Liquid, and Solid States,	2385
	Phase Rule Studies on the Proteins. V,.....	2433
	A Note on the Formation of Long-lived Active Molecules of Hydrogen subjected to the Action of Alpha Particles from Radon,.....	2472
<i>Wilder D. Bancroft and H. L. Davis, Maurice Lecat, Basil Soyenkoff,</i>	The Boric Acid Problem,.....	2479
	A New Application of Azeotropism,.....	2508
	Benzene Dispersions of Basic Soaps of Nickel and Iron,.....	2519
<i>J. N. Rakshit,</i>	Mutarotation in Pure and in Mixed Solvents,.....	2539

<i>P. E. Verkade</i> <i>and Y. Coops, Jr.,</i> <i>W. W. Russell and</i> <i>R. F. Marschner,</i> <i>P. A. Levene and</i> <i>Alexandre Rothen,</i> <i>A. A. Sumier,</i>	The Heat of Combustion of Salicylic Acid,.....	2549
	The Effect of Water upon the Decomposition of Ethyl Alcohol at the Surface of Nickel,.....	2554
	Optical Activity and Salt Effect,.....	2567
	The Solubility of Naphthalene in Some Aliphatic Alcohols,.....	2582
<i>F. D. Miles and</i> <i>Maurice Milbourn,</i> <i>F. D. Miles and</i> <i>James Craik,</i> <i>Simon Klosky,</i> <i>H. D. Crockford</i> <i>and A. E. Hughes,</i> <i>G. H. Damon,</i> <i>G. H. Ayres and</i> <i>C. H. Sorum,</i> <i>New Books,</i>	The Structure of Nitrated Cellulose. I,.....	2598
	The Structure of Nitrated Cellulose. II,.....	2607
	Titania Gel,.....	2621
	The Photographing of Cooling Curves,.....	2624
	Double-Pole, Double-Throw Mercury Switch,.....	2627
	A Study of the Influence of Hydrolysis Temperature on Some Properties of Colloidal Ferric Oxide. II,	2629
		2636
12. DECEMBER		
<i>F. C. Krack,</i> <i>R. J. Hartman</i> <i>and O. W. Brown,</i> <i>E. J. Miller and</i> <i>S. L. Bandemer,</i> <i>A. G. Weber and</i> <i>J. H. Walton,</i> <i>E. R. Washburn and</i> <i>Albert Lightbody,</i> <i>W. E. Bradt,</i> <i>S. E. Sheppard and</i> <i>W. Vanselow,</i> <i>S. N. Chakravarti</i> <i>and N. R. Dhar,</i> <i>H. A. Taylor,</i>	The Binary System $\text{Li}_2\text{O-SiO}_2$ ,.....	2641
	Catalytic Activity of Cadmium,.....	2651
	Adsorption from Solution by Ash-free Adsorbent Charcoal. VI,.....	2666
	Studies on Phosphoric Acid. III,.....	2693
	The Changes in Volume and Temperature that ac- company the Mixing of Organic Liquids. I,....	2701
	The Catalytic Preparation of 2-4 Diaminophenol,..	2711
	The Lattice Energies of the Silver Halides and their Photochemical Decomposition. II,.....	2719
	Slow and Induced Oxidation of Potassium Oxalate, Sodium Nitrite and Sodium Sulphite by Air,....	2749
	The Decomposition of Ethylamine. A Unimolecular Reaction,.....	2761
<i>J. C. Ghosh, D. N. Das Gupta,</i> <i>N. C. Roy and</i> <i>H. K. Chatterjee,</i> <i>L. A. M. Henry,</i>	Studies on the Photosensitizing Action by Iodine,..	2771
	On the Mechanism of the Synthesis of the Nitrogen Oxides,.....	2782
	Liquid Ammonia as a Lyophilic Dispersion Medium,	2792
	The Critical Constants of Carbon Dioxide-Oxygen Mixtures,.....	2801
	A Study of the Influence of Hydrolysis Temperature on Some Properties of Colloidal Ferric Oxide. III,	2826
<i>Robert Taft</i> <i>H. S. Booth and</i> <i>J. M. Carter,</i> <i>G. H. Ayres and</i> <i>C. H. Sorum,</i> <i>J. A. V. Butler and</i> <i>Charles Ockrent,</i> <i>C. G. Maier,</i> <i>New Books,</i> <i>Errata,</i> <i>Name Index,</i> <i>Index to New Books,</i> <i>Subject Index,</i>	Studies in Electrocapillarity. III,.....	2841
	Resistance Thermometers for Chemists,.....	2860
		2869
		2870
		2871
		2881
		2883





## IRON OXIDE IN BORATE BEADS\*

BY WILDER D. BANCROFT AND G. E. CUNNINGHAM

The colors ordinarily imparted to glass by iron oxide are green and yellow, the yellow corresponding to a higher state of oxidation. Heretofore, the green color has been quite generally attributed to ferrous oxide and the yellow color to ferric oxide. Thorpe<sup>1</sup> is of the opinion that ferrous oxide combines with silica to form a green silicate.

Advantage is taken of the change from green to yellow upon oxidation, in the decolorization of glass for commercial purposes.<sup>2</sup> "Within narrow limits of iron oxide content, the greenish colour produced by ferrous oxide can be removed by decolorizers. Oxidizing agents such as sodium and potassium nitrates tend to retain or produce the higher ferric state of oxidation which has but slight colour, namely, straw or yellow. Arsenious oxide, which is readily reduced, assists in the oxidation of carbonaceous matter which would otherwise reduce the iron to the ferrous condition.

"The usual decolorizing agents, however, are those which when present alone are colouring agents, namely, manganese dioxide, nickel oxide and selenium. Potassium glass showing the first-named oxide shows most marked absorption in the yellow and green part of the spectrum, the red and violet being transmitted. A glass with iron oxide, on the other hand, transmits green and yellow to the greatest extent, whilst the red and blue show absorption. When the two oxides are present in small amounts simultaneously, they each absorb what the other transmits, resulting in a slight general absorption only. Although the resulting glass may appear colourless, the reduction in the light transmitted tends to create a dull or greyish appearance."

In connection with this, it is a point of considerable significance that Thorpe also mentions a specific effect due to the glass composition: "Manganese dioxide does not completely decolorize sodium glasses, a brownish tinge being left, which is removed when a minute amount of cobalt oxide is added with the manganese dioxide."

The statement that the green color is caused by ferrous oxide is also made by Rogers,<sup>3</sup> and he, too, mentions the decolorization of glass by the use of oxides of manganese. "When in the ferrous state, *iron* colors glass green, and

\*This work is part of the programme now being carried out at Cornell University under a grant to Professor Bancroft from the Heckscher Foundation for the Advancement of Research established by August Heckscher at Cornell University.

<sup>1</sup> "Dictionary of Applied Chemistry," 3, 384 (1922).

<sup>2</sup> Thorpe: "Dictionary of Applied Chemistry," 3, 387 (1922).

<sup>3</sup> "Manual of Industrial Chemistry," 1, 358 (1925).

yellow when in the ferric condition. The temperature of the furnace, however, materially affects the state of oxidation of the iron, changing it from yellow to green.

*Manganese.* Black oxide,  $MnO_2$ , is the most used of all the colored oxides. In large quantities it produces black and in less amount purple to light pink color. It is used to correct the color effect of iron, which is always more or less present in glass material. It acts as an oxidizing agent also. The quantity of manganese to be used depends on the amount of iron present and the temperature of the furnace, as the hotter the furnace the more manganese is required. The heat 'burns out the color.' The impurities met with are usually iron and earthy matter."

Bancroft and Nugent<sup>1</sup> have shown that the same decolorization effect may be produced by mixing the oxides of iron and manganese in borax melts. The "burning out of the color" is due to the breaking down of manganic oxide,  $Mn_2O_3$ , at the high temperature into the colorless, manganous form.

The discovery of the fact that iron oxide may impart a blue color to glass dates back at least 150 years, notwithstanding it is little known. Beckmann<sup>2</sup> states that we should have been almost obliged to adopt the opinion that the Chinese used smalt to color their porcelain blue, "had not Mr. Gmelin<sup>3</sup> proved by chemical experiments that it is not only possible to give glass and enamel a blue colour by means of iron; but that the before-mentioned antiquities, upon which so much stress has been laid, show not the smallest traces of cobalt. He even made experiments upon blue tiles, found in a Roman tessellated footpavement at Montbeillard; and likewise on the blue paint of the mummy which was presented to our university [Göttingen] by the king of Denmark. He has also mentioned various articles on which a blue colour is produced by the vitrification of iron. Of this nature are in particular those slags found near the smelting-houses at the iron-mines of the Harz forest; and I myself have seen slags which were of a blue colour exceedingly beautiful. Volcanic slags, or scoriae, found in the neighbourhood of Verona, Vicenza, and other parts of Italy, are mentioned also by Ferber<sup>4</sup>, which seem to confirm the conjecture of Dr. Bruckmann,<sup>5</sup> that the ancients may have used such slags for their works. It is probable that the ancients were first induced by the blue slags of their smelting-houses to make experiments on the colouring of glass with iron, and that in this art they acquired a dexterity not possessed at present, because it was abandoned by our ancestors after the invention of smalt, which is more beautiful; and which can be used more easily and with more certainty. I cannot, however, deny that I have often lamented this loss when I saw the excellent blue in the painted windows at Gouda, Goslar, and other places; though its beauty is much heightened by the transparency of the glass, and the strong light that falls upon it from without."

<sup>1</sup> J. Phys. Chem., 33, 492 (1929).

<sup>2</sup> "History of Inventions and Discoveries," 2, 340 (1814).

<sup>3</sup> Commentationes Societatis Göttingensis, 2, 41 (1779).

<sup>4</sup> Briefe, 30.

<sup>5</sup> "Beyträge zu der Abhandlung von Edelsteinen," 55 (1778).

The blue color was also noticed by Silliman. Describing the properties of ferrous oxide, he says:<sup>1</sup> "*Color blue, imparts that color to vitreous bodies.*"

Early reference is found to reds and oranges, in addition to yellows, greens, and blues, produced by iron oxide in glass. In a paper read before the British Association for the Advancement of Science in 1849, Bontemps<sup>2</sup> made the following statement:

"It is generally admitted that oxide of iron gives a greenish colour to glass to the mixture of which it has been added; but the truth is, that this colour is produced *only* in peculiar circumstances.

"The manufacturers of china, porcelain, and earthenware are well aware that oxide of iron is the colouring material of a fine *purplish red* enamel fired in their muffle (and it is quite clear that *enamels* are real *glass*); if the temperature were raised too high this enamel would lose its purplish tinge and tend towards *orange*, so that three colours of the spectrum are produced by oxide of iron, even at degrees of heat which I should call *low*, compared with the temperature of furnaces for glass-melting, which we shall now consider.

"If into a pot containing white melted glass or flint glass we introduce during the blowing a small fragment of iron, it will, from its gravity, fall to the bottom; now, if after the blowing, this pot is taken out of the furnace, we shall see close to the fragment of iron partly oxidized, a portion of the glass coloured from *orange* to *yellow*. . . .

"Proceeding now to the usual circumstances of colouring glass by oxide of iron, we find that at a temperature not very high, for instance in covered pots for flint glass, oxide of iron gives a *green* colour approaching nearer to yellow than to blue. It is generally by mixing oxide of iron with oxide of copper (giving blue) that all the green tints are produced. The greenish colour of bottle-glass must be attributed to the oxide of iron combined with the carbonaceous matters contained in the mixture. But when we melt at a high temperature, for instance in the manufacture of window-glass, we remark that the addition of a small proportion of oxide of iron to the mixture produces a glass of *bluish* colour. It is known also by the manufacturers of bottle-glass that when the glass is cooled in the pot, it becomes opaque *blue* before being devitrified.

"We have shown by the preceding remarks that glass *receives all the colours of the spectrum from oxide of iron*; and at the same time, it will be observed that *these colours are produced in their natural order in proportion as the temperature is raised.*"

A blue iron oxide glass has been described more recently by Zsigmondy:<sup>3</sup>

"Three batches of glass mixed with iron were heated for equal periods in a porcelain oven at the temperature of a strong flame. The glass mixes contained additions of iron oxide and reducing agents. The flame was held in a reducing condition.

<sup>1</sup> "Elements of Chemistry," 2, 256 (1831).

<sup>2</sup> Phil. Mag., (3), 35, 440 (1849). See also: J. prakt. Chem., 49, 177 (1849); Jahresber. Fortschritte Chemie, 1849, 651; Chem. Gaz., 1849, 406; Gmelin-Kraut: "Handbuch der anorganische Chemie," 2, 1, 903 (1886).

<sup>3</sup> Dingers polytech. J., 287, 21 (1893).

"I shall designate the three glasses by the letters A, B and C. A contained one percent of iron oxide, B two percent and C four percent of iron oxide.

"By the process of reduction, the oxide in glass A was rather completely reduced to the ferrous state, at least so the color indicated; in B and C the extent of reduction was doubtful. I have not yet analyzed the glasses, for I shall reserve the study of the relation of iron to glass for a later study. Glass A is decidedly blue, with a tinge of green. It had about the color which copper oxide imparts to glass. B, on the contrary, is colored green, C dark green.

"The intensity of the color does not readily lend itself to description; furthermore, I had no color scale at hand with which to make a comparison. However, the resulting color was less than one would expect from the iron content.

"The samples looked as if the ferro-ferric oxide had imparted to the glass the unpleasant bottle-green color. On the other hand the pure ferrous oxide, contained in the same quantity in the glass, produced a light blue, which was pleasant to the eye, and which had nothing in common with the color which iron ordinarily imparts to glass.

"I cut plates of 8 to 8.5 mm. thickness from these glasses. Unfortunately, the plates were not free from imperfections, since glass melted in a chamotte sagger shows splotches and streaks of color. However, these were without pronounced influence upon the results of the investigation, as I have convinced myself with other glasses.

"Through the 8 to 8.5 mm. plate of glass C, I could read quite plainly the type on well-illuminated paper. Glass C, when investigated with the spectroscope, transmitted only a part of the red, then yellow, green and blue; likewise glass B, but to a much different degree, whereas one could observe with an 8-mm. thickness of A merely a small diminution of the violet and absorption in a small part of the red (near the Fraunhofer line C), the other colors passing through nearly unchanged.

"In strips of 2 mm. thickness, B was bright green, and A was colored quite blue."

Mention of shades other than green caused by the presence of ferrous oxide in glass is made by Sir Herbert Jackson,<sup>1</sup> who offers the interesting, if not very explanatory, suggestion that the color of the ferrous oxide is modified by the presence of other materials in the glass. "Passing on now to iron, there are colors produced by ferric oxide, ferroso-ferric oxide and ferrous oxide, but I do not know of any glass or any material which could be called glassy which owes its colour to metallic iron in a fine state of dispersion. Starting in the first place with ferrous oxide, which gives the well-known green colour to glass of the nature of window glass, I need only point out that this colour is considerably modified by the composition of the glass, and without going into a number of details I will mention the way in which the

<sup>1</sup> Nature, 120, 266 (1927).



tint is modified by the presence in the glass of zinc oxide or magnesium oxide. The former intensifies the colour produced by any given amount of ferrous oxide and changes the usual green into almost a blue. A similar change occurs with magnesium oxide, but the intensification of the colour is less marked. Among the alkalis, lithium oxide also tends to give a bluish tint to glasses containing ferrous iron. A notable example of this is seen in an early Chinese glaze which, through the kindness of Mr. G. Eumorfopoulos, I had the opportunity of examining. The thinner parts of this glaze are practically colourless, but the thicker parts have a beautiful blue tint. An examination of the glaze showed that it was, for such glazes, unusually rich in both lithium oxide and magnesium oxide, and the colouring material was identified as iron. If the Chinese workers had substituted zinc oxide for magnesium oxide in their glaze mixture, the colour would have been very much more marked."

The discussion continues<sup>1</sup> with a description of other colors than yellow produced by the presence of ferric oxide in glass: "Before dealing with the colours and effects produced by ferric oxide in glasses and glazes, let me direct attention first to the different shades of colour which can be seen in varieties of the oxide itself. These range from a reddish yellow through brick reds, bright reds, to a rich brown red and almost to a black. Some specimens also have almost a bronze-like appearance. The range of colours produced when ferric oxide is used as a colouring agent for glasses and glazes is practically as great. It is doubtful if the colours produced by ferric oxide are due to compounds of this oxide with the other constituents of the glass. Without going into elaborate detail, it is somewhat difficult to give adequate support to this statement. Perhaps the simplest way of dealing with it is to take the behaviour of ferric oxide in lead glasses, frequently described as flint glasses. There are light flints and dense flints. In the light flints there is always a notable quantity of an alkali such as potash or soda along with the lead oxide. In the dense flints the proportion of alkali is decreased and the proportion of lead oxide is increased.

"Now, taking three such glasses as examples, having specific gravities of 3.2, 3.8 and 4.8, it is possible to add a known, but small, quantity of ferric oxide to the first glass and still produce a glass having no detectable yellow colour to the eye. The same amount of iron added to the second glass will give a noticeable yellow colour, and added to the third glass will give a marked yellow colour. The glass of specific gravity 3.2 contains a notable proportion of alkali, and there is reason to believe that this either promotes the formation of a compound of ferric oxide with the alkali or the formation of a soluble silicate, either sodium ferric silicate or potassium ferric silicate; such compounds appear to be colourless. If the quantity of iron be increased, then a colour can be produced in the light flint, and by increasing the percentage of ferric oxide to 5 per cent., a fairly strong yellow is produced. With 10 per cent. of ferric oxide an even richer red colour can be seen when looking through a thickness of  $\frac{1}{2}$  mm.; but in thicknesses of 1 mm. or more the glass is prac-

<sup>1</sup> Nature, 120, 301 (1927).

tically opaque. When the percentage of iron is raised much higher, some of the ferric oxide crystallizes out from the glass on cooling, and with 40 percent. of ferric oxide the small crystals dispersed through the glass can be seen with a hand lens. With the denser flints, containing a lower percentage of alkali, colours similar to those described above are produced with much smaller proportions of ferric oxide.

"A reasonable explanation of this would be on the same lines as the suggestions made in dealing with cuprous oxide and metallic copper, namely, that the light yellow colour is due to a small amount of free ferric oxide dispersed in the glass as extremely fine particles; the transparent deep yellows and brownish reds would represent a greater concentration of ferric oxide similarly dispersed, possibly also, as the percentage of ferric oxide gets higher, as somewhat larger particles. In the 20 percent. glass mentioned the particles are still too small to be seen, but in specimens of lead glass containing nearly 30 percent. of ferric oxide, fine clouds of almost irresolvable particles can be seen in the microscope.

"Leaving the subject of lead glasses coloured with ferric oxide, I would first mention the behaviour of ferric oxide in a glass containing a large proportion of phosphoric acid, an acid which in glasses may be described as a much stronger acid than silica. Ferric phosphate is a definite compound and colourless; in this phosphoric acid glass, quite a notable proportion of ferric iron may be present without showing any colour. Evidence that the iron is in the ferric state is obtained by heating the glass in a highly reducing atmosphere; this reduces the ferric iron to the ferrous state, and the glass is found to have developed a marked indigo blue colour, due, possibly, to ferrous phosphate, or to a ferrous phosphate along with a very small proportion of unreduced ferric phosphate.

"In such glasses as ordinary sodium calcium silicates, it is rather difficult to obtain light pure yellow colours with ferric oxide. Much use has been made of ferric oxide in producing glazes which are of a deep colour, practically black in moderately thick layers, though of a fine golden brown in thinner layers. These glazes are frequently described as felspathic glazes, and their composition may be given as sodium or potassium aluminum silicates. To get the deep colour of these glazes, amounts of ferric oxide of the order of about 12 per cent. are required. If the percentage of ferric oxide is raised to about 15-20 per cent. some of the ferric oxide separates out on cooling and, according to the concentration of the ferric oxide, so may be seen a fine brown red colour on the surface of the glazes or bronze-like spangles of ferric oxide, or rosettes, or tree-like crystals, or even more massive crystals which to the eye look black. The Chinese made much use of this behaviour of ferric oxide. As the result of a close microscopic study of certain Chinese glazes owing their colour to ferric oxide, which I undertook in collaboration with Mr. A. L. Hetherington, he was able to explain how the varied and beautiful effects seen on certain specimens of Chinese porcelain could be obtained, and to show many similar glazes produced in the laboratory to support the explanation put forward.

"Ferroso-ferric oxide, magnetic oxide of iron, gives in certain cases neutral tints of various depths, but with high concentration of this oxide a black glass can be obtained. If the concentration of the ferroso-ferric oxide be high enough, some of this oxide will come out on cooling so as to be dispersed through the glass in very minute aggregations, which are, however, presumably crystalline, since the resulting glass is appreciably magnetic. The above remarks refer to glasses containing the whole of the iron in the ferroso-ferric form. If a ferrous iron glass or glaze contains some ferric iron, the green colour due to the ferrous iron will be modified and various olive green tints can be obtained. There are many such coloured glazes in which the iron is principally in the ferrous state, but there is sufficient ferric iron present to produce the olive green tint. In a similar way small quantities of ferrous iron in a glass which contains appreciable quantities of ferric iron will modify the yellow or brown colours due to the ferric iron and give somewhat dusky hues."

Considering for a moment the colors which iron oxides impart to clays during the burning process, one might mention that they are without effect unless present to the extent of at least one per cent. in the clay, produce various shades of buff when present up to three per cent. and produce a variety of colors depending upon the other substances present in the clay when present in amounts greater than three percent.<sup>1</sup>

Lime has what Seger<sup>2</sup> describes as a bleaching effect on the red colors of iron. Light reds are obtained at low temperatures, muddy browns or brown buffs at the initial vitrification point and yellows or greens at temperatures of complete vitrification.<sup>3</sup>

Reference has already been made to a specific difference between soda glass and potash glass, namely, that the former is not completely decolorized by the addition of oxides of manganese, but is decolorized in the presence of small amounts of cobalt oxide. Further mention is made of the differences between soda and potash glasses with respect to the colors imparted by iron oxide:<sup>4</sup> "Iron in the ferrous state produces a green coloration. Small quantities of iron are always found as an impurity unless special precautions are taken to exclude it, so that common glass is slightly green in colour, the colour being bluer in the case of potash than in soda glasses. If oxidized to the ferric state, the colour produced is yellow and of less intensity. About two percent of iron will produce a strong green or yellow coloration, according to the state of oxidation."

In a discussion of the problem of colors in glasses and glazes, Bancroft<sup>5</sup> has said: "Iron usually colors glass green or yellow; in glazes one may get blacks, blues, browns and reds. If we consider the iron as dissolved in the glass we should expect to get a green with ferrous salts and a yellow with

<sup>1</sup> Wilson: "Ceramics—Clay Technology," 43 (1927).

<sup>2</sup> "Collected Writings," 1, 115.

<sup>3</sup> Wilson: "Ceramics—Clay Technology," 160 (1927).

<sup>4</sup> Thorpe: "Dictionary of Applied Chemistry," 2, 721 (1912).

<sup>5</sup> J. Phys. Chem., 23, 603 (1919).

ferric salts by analogy with aqueous solutions, and that is what we actually do get. There are difficulties in regard to this, however. While ferrous sulphate with seven of water is green, the salt with one of water is colorless, and it is a question how far one is justified in reasoning from the aqueous solution to the silicate solution."

The uncertainty involved in drawing conclusions with regard to the colors of glasses by comparisons with aqueous solutions led to a search for a better method of studying the chemistry of coloring agents in glass. Bancroft and Nugent have shown that the color changes produced in glass by varying the conditions in the presence of oxides of manganese<sup>1</sup> and copper<sup>2</sup> may be duplicated practically in borax melts. The fact that the green and yellow colors due to iron oxides may be obtained in the borax bead<sup>3</sup> led to the supposition that the same procedure might be employed to study the chemistry of the latter oxides, and that the other colors, particularly the blue, might be produced and their cause determined.

#### Experimental

The experimental method was essentially that employed by Bancroft and Nugent. Borate melts were prepared in number O porcelain crucibles (except the ones with high alkali content, for which a platinum crucible was employed), the color of the melt being determined from time to time by removing a drop on the end of a glass rod and allowing it to cool. The introduction of iron to the extent of two to three percent of the calculated net weight of the melt, in the form of the oxide, was found to give a convenient depth of color.

For the preliminary experiments, the crucibles were held in a perforated asbestos board placed in an inclined position over the open flame of a Fisher burner. A glass jet was clamped in such a position that air or gas could be blown into the mouth of the crucible for the purpose of producing an oxidizing or a reducing atmosphere.

Using melts of sodium tetraborate, observations were made of the colors produced in both oxidizing and reducing conditions. As was to be expected, yellow beads were obtained in the oxidizing atmosphere, and upon reduction were converted to green. Rapidity of reduction was favored by higher temperatures, and it was found that upon changing from an oxidizing to a reducing atmosphere and heating to the highest temperature available with the open flame the color changed consecutively from clear yellow to greenish yellow, then to yellowish green, olive green and dark green. Sir Herbert's observations on the effect of zinc oxide upon the color of glass led to the making of trial melts with the addition of various amounts of that substance. The addition of small quantities of zinc oxide (up to 15 mol percent) had no visible effect upon the color of the melt. The effect of higher concentrations was to intensify the yellow in the oxidizing atmosphere and give a yellower green in the reducing flame.

<sup>1</sup> J. Phys. Chem., 33, 481 (1929).

<sup>2</sup> J. Phys. Chem., 33, 729 (1929).

<sup>3</sup> Treadwell-Hall: "Analytical Chemistry," 1, 426 (1916).

It was to be supposed that the blue coloration would be obtained, if at all by a more complete reduction of the iron. The apparatus was accordingly arranged so that higher temperatures could be obtained, by surrounding the flame with a clay chimney about 7.5 cm high and 7.5 cm in diameter. The asbestos board holding the crucible was laid across the top of the chimney, and was elevated slightly on one side in order to produce a draft. The bottom of the chimney was about .5 cm above the level of the top of the Fisher burner, and a second asbestos board, perforated to admit the flame, was placed at the level of the top of the burner. This second asbestos board served the dual purpose of reflecting heat back into the chimney, and thereby increasing the temperature, and of keeping the lower portion of the burner cool so that it did not strike back. The temperature of this furnace was not measured, but it probably was well above 1,000° C. when heated with the full flame. Since the admission of cold illuminating gas tended to cool the material in the crucible, Rochelle salt was used as the reducing agent at higher temperatures.

For these and all later melts, mixtures were used which were made up of alkali (added as carbonate) and boric oxide (added as boric acid) in various proportions. It was found, quite contrary to expectation, that increasing the alkali content of the melt tended to favor the production of blue color. At times, using Rochelle salt as the reducing agent, it was possible to produce melts which were either pure sky blue or of a blue color with only a faint tinge of green. It was also found that the blue could be produced more readily if a small quantity of lead oxide or calcium oxide were added to the melt. The blue color was quite fugitive, however, frequently changing to green upon the further addition of tartrate. Sodium oxalate was tried as a reducing agent without success in producing a blue color. Both of these substances were altering the alkali content of the melts, and in order to simplify matters, cane sugar was tried as a source of reducing material. With this substance, however, the green seemed to be intensified. The reason for these puzzling and apparently anomalous results was not evident at the time, but was brought out later by quantitative experiments.

It was quite evident that a stronger reducing agent was needed, and one which would not alter the alkali content of the melt was much to be preferred. Hydrogen seemed to be well suited for the purpose, provided the reduction of ferrous oxide to metallic iron could be prevented.

The formation of the blue color upon reduction with Rochelle salt and its reversion to green upon further additions of the same agent, as well as the observation that moderate concentrations of alkali seemed to be more favorable than low concentrations to the formation of blue, appeared to indicate that there might be an optimum intermediate concentration of alkali which favored the formation of ferrous oxide. It was accordingly decided to treat a number of mixes of different alkali concentrations with hydrogen until equilibrium was reached, and analyze the resulting melts for percent of ferrous iron in total iron present.

In each case, the materials in the mix were weighed to the nearest milligram, and were made up so as to contain an amount of iron equal to 2.5 percent of the calculated net weight of the melt, added as iron oxide. Enough material was taken to give about 3 g of glass. The mixtures were placed in a Rose crucible resting in the asbestos board across the top of the clay chimney, as described above. Heating was carried on in an atmosphere of hydrogen, at atmospheric pressure, until no further change in the color could be noted over a period of 20 to 30 minutes. The total period of heating was, on an average, about 2 hours.

The molten material was then poured from the crucible in drops on a clean stone slab, allowed to cool below a red heat, and then dropped into a beaker of cold water. When the molten material was poured direct into water, there was a rapid disintegration of the drops and danger of partial oxidation of the iron. The final rapid cooling in water served the purpose of partly disintegrating the beads so that they were more readily pulverized in a mortar, without appreciably affecting their color. A portion of the beads was then pulverized and dissolved in 100 cc of hot, freshly boiled, distilled water, to which 10 cc of concentrated sulphuric acid had been added. Two 50-cc portions of the resulting solution were measured out with a pipette, one portion being titrated immediately with dilute permanganate solution, and the other being heated with metallic zinc until a drop no longer gave a red coloration with ammonium thiocyanate, and then titrated. A weighed amount of zinc was used, and correction made for the iron contained in the zinc. The chemical solution of the last traces of zinc was catalyzed by the addition of a few drops of N/10 silver nitrate solution.

The ratio of the respective amounts of permanganate required gave the fraction of ferrous iron in total iron. A curve (not reproduced in this paper) was prepared, from which the corresponding mol per cent of ferrous oxide in total iron oxide could be determined from the above ratio. This curve was based upon theoretical values calculated at intervals of ten mol percent change in ferrous oxide.

The accuracy of the analytical method was tested by running a set of analyses on the iron oxide used in the experiments (Merck's magnetic oxide, "By the 'so-called' wet process"). Two samples were analyzed for ferrous iron and two other samples for total iron, the permanganate having been standardized for this purpose against sodium oxalate. The volume of permanganate used in each case was reduced to a basis of 1 g of sample, and the percent of ferrous iron in total iron was also determined from the permanganate ratio. The percent of ferrous iron in total iron based upon the concentration of the standardized permanganate (and allowing for the one percent of inert material in the sample) was 56.0. The corresponding value based upon the ratio of the average respective volumes of permanganate required for ferrous and total iron was 57.3 percent, a difference of 1.3 percent. However, the titrations of the two samples for ferrous iron checked to 1.6 parts in 1,000, and the titrations of the two samples for total iron to 0.28

parts in 1,000. The sodium oxalate used for the permanganate standardization was Kahlbaum's C.P., no analysis being given. It is therefore supposed that, while the values obtained in the analyses of the melts for percent ferrous iron may not be absolutely correct, they are relatively correct to within one or two units in the first decimal place. This method of analysis has the advantage that the results are independent of the weight of the glass sample taken and of the concentration of the permanganate solution used. It makes no distinction, however, between metallic and ferrous iron, but this

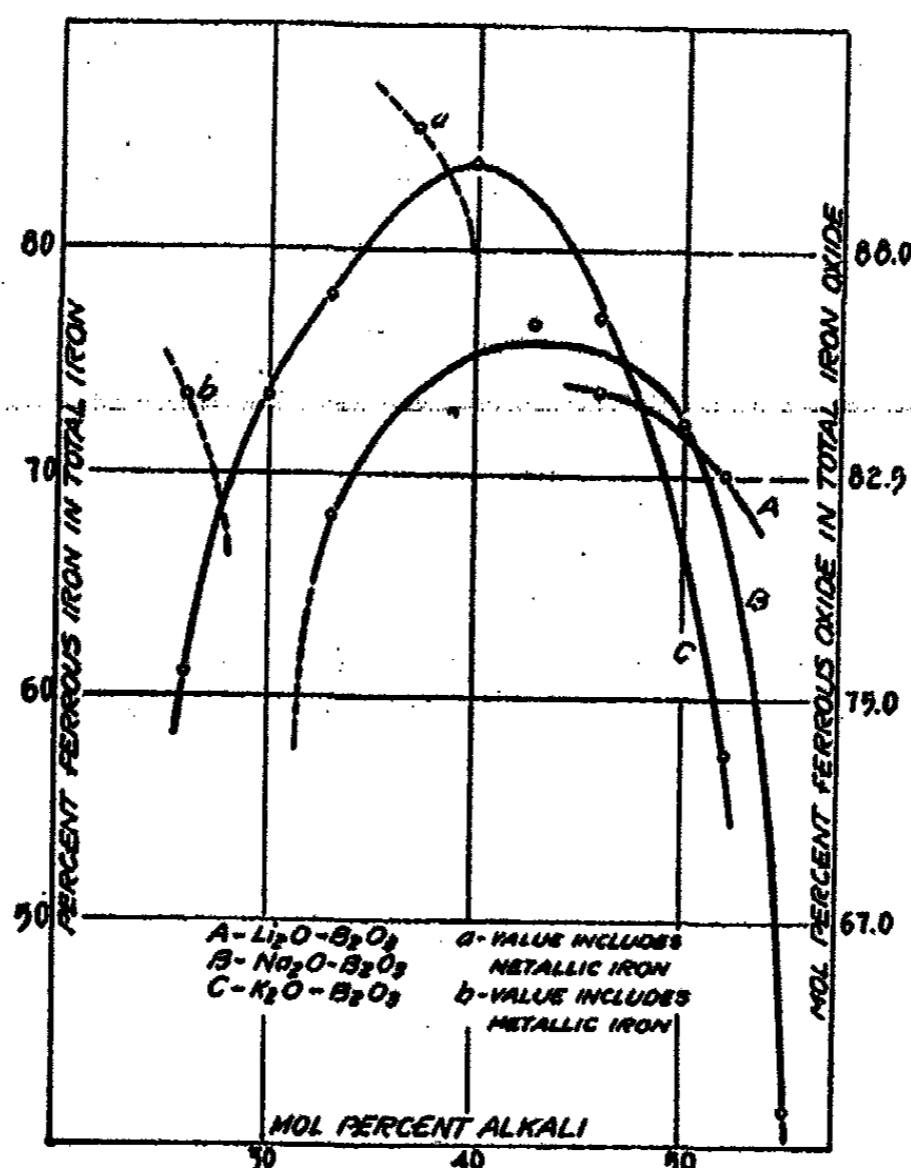

FIG. 1

Percent of Ferrous Iron, on Basis of Total Iron, in Melts of Different Proportions of Alkali and B<sub>2</sub>O<sub>3</sub>, at Equilibrium in an Atmosphere of Hydrogen at Atmospheric Pressure.

objection is of no consequence in the general result because there was no difficulty in judging, by the appearance of the bead and the location of the point on the curve, when the melt contained metallic iron.

The first series of runs was with melts made up of various proportions of sodium oxide and boric oxide. Later, runs were made with potassium-oxide-boric oxide and with lithium oxide-boric oxide mixtures. The results of the analyses are given in Table I, and are represented by the curves in Fig. 1. Melts were made, but not analyzed, consisting of 100 percent boric oxide. The amount of iron added had to be cut in half in order to secure complete solubility. In an oxidizing atmosphere, an intense red coloration was obtained. After heating in an atmosphere of hydrogen at a very high tem-

perature (a blast Meker having been substituted for the Fisher burner), and then allowing the melt to cool in the crucible for the reason that it was too viscous to pour, it was found that the upper portion of the material was still red, whereas the black material resulting from the reduction had settled to the bottom, notwithstanding the fact that the greater concentration of reducing agent probably obtained in the upper stratum. In other words, the reduced material, largely metallic iron in all probability, appeared to be insoluble in the molten boric oxide.

TABLE I

Observations on Iron-containing Melts of Different Proportions of Alkali and Boric Oxide, at Equilibrium in an Atmosphere of Hydrogen at Atmospheric Pressure

Formula	Alkali mol percent	B <sub>2</sub> O <sub>3</sub> , mol percent	Percent Fe <sup>++</sup>	FeO, mol percent	Color
Na <sub>2</sub> O	20	80	—	—	Black
	26	74	73.5*	—	Gray
	33	67	68.1	81.	Murky green
	39	61	72.5	84.	Greenish blue
	43	57	76.8	86.5	Faintly greenish blue
	50	50	72.3	83.5	Greenish blue
	55	45	41.5	59.	Green
K <sub>2</sub> O	26	74	60.9	76.	Bluish green
	30	70	73.5	85.	Greenish blue
	33	67	78.0	87.5	Sky blue
	40	60	84.0	91.5	Intense sky blue
	46	54	77.0	89.	Sky blue
	46	54	76.8	89.	Sky blue
	52	48	57.4	73.	Bluish green
	Li <sub>2</sub> O	37	63	85.5*	—
46		54	73.8	85	Greenish blue
52		48	69.9	82	Bluish green

\*Value given includes metallic iron.

It will be observed by referring to Table I that, in the case of the soda, potash, and lithia mixes, the color is the same for the same percent of ferrous oxide, and becomes bluer as the percent of ferrous oxide increases. Inasmuch as it had been observed in the preliminary experiments that additions of calcium oxide and lead oxide aided in the production of a blue color upon reduction with Rochelle salt, a series of analyses were made of melts in which (a) calcium oxide had been substituted for sodium oxide at the optimum concentration and (b), calcium oxide had been added to the mix in different proportions, keeping the sodium oxide to boric oxide ratio constant at the optimum concentration for those two substances taken alone. The results



of these analyses are given in Table II and plotted in Fig. 2. Analyses were not made of melts containing lead oxide for the reason that there was always a separation of metallic lead at the high temperature and in the reducing conditions employed, so that the percent of lead oxide in the resultant product could not be determined conveniently.

A single analysis was run of a mixture containing zinc oxide added to sodium oxide-boric oxide in a concentration corresponding to the optimum value for calcium oxide, and another in which magnesium oxide was used instead of calcium oxide.

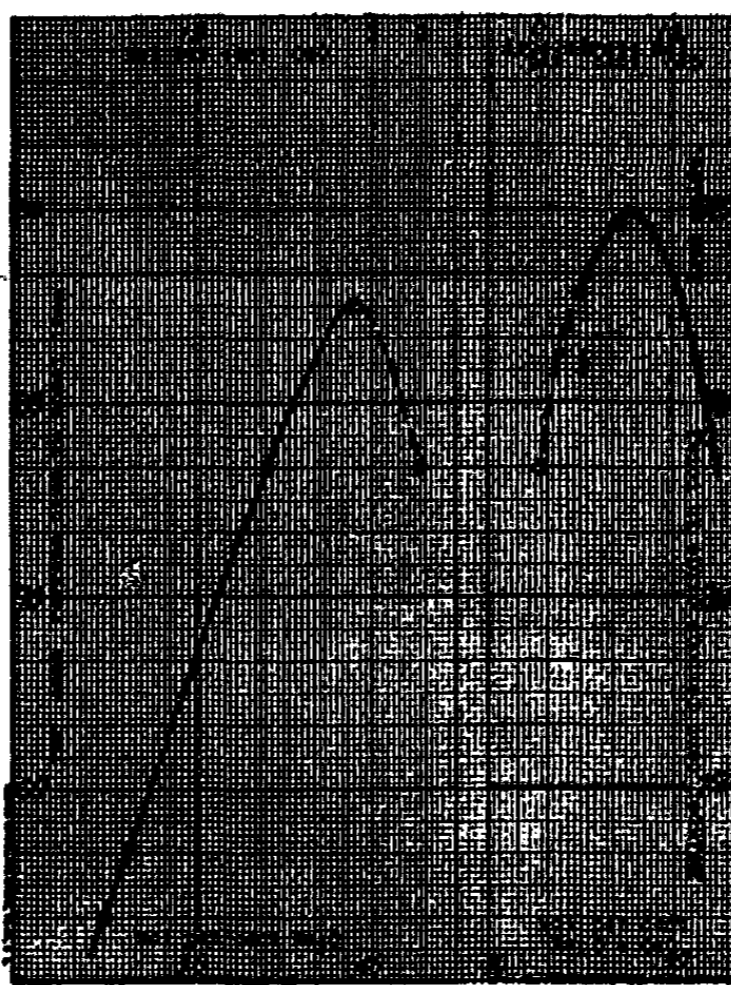

FIG. 2

A: Mol percent  $B_2O_3$  = constant = 57.  
 B: Molar ratio  $Na_2O/B_2O_3$  = constant = 43/57.  
 Percent of Ferrous Iron, on Basis of Total Iron, in  
 $Na_2O-CaO-B_2O_3$  Melts, at Equilibrium in an Atmos-  
 phere of Hydrogen at Atmospheric Pressure.

It was not supposed that the optimum concentrations of calcium, zinc, and magnesium oxides would be the same; but it was expected that the employment of the same concentration would show qualitatively whether or not the latter oxides would increase the proportion of ferrous iron. The results, which are also given in Table II, justified the supposition.

Special mention should be made of the fact that, notwithstanding a higher content of ferrous iron, the beads containing calcium, zinc, or magnesium oxide were not as blue as the ones composed of alkali and boric oxide alone. An explanation of this phenomenon will be offered in the next section of this paper.

TABLE II

Observations on Iron-containing Melts of Sodium Oxide, Boric Oxide and a third, added, Oxide, at Equilibrium in an Atmosphere of Hydrogen at Atmospheric Pressure

Formula	Added oxide mol percent	Na <sub>2</sub> O, mol percent	B <sub>2</sub> O <sub>3</sub> , mol percent	Percent Fe <sup>++</sup>	FeO, mol percent	Color
CaO	4	39	57	85.0	91.8	Sky blue
	9	34	57	76.7	87.	Faintly greenish blue
	18	25	57	53.5	70.	Murky green
CaO	3	42	55	85.7	92.	Greenish blue
	7	40	53	89.3	94.	Faintly greenish blue
	16	36	48	81.5	90.	Green
ZnO	7	40	53	85.6	92.	Bluish green
MgO	7	40	53	82.5	90.5	Green

#### Discussion of Results

*Theoretical.* In borate melts of very low alkali content, the formation of metallic iron in an atmosphere of hydrogen is indicated by the murky appearance of the beads and by the results of the analyses, showing abnormally low content of ferric oxide. As the concentration of alkali approaches zero, the iron oxide in all likelihood tends to be completely reduced to metallic iron, and the curves representing this change would probably assume the general direction indicated by the dotted lines through the points (a) and (b) in Fig. 1.

As the concentration of a given alkali increases beyond a certain critical value, the formation of metallic iron is prevented, but the fraction of ferric iron is high at the expense of ferrous iron. Further increase of alkali content increases the fraction of ferrous iron, until an optimum alkali content is reached, and then the per cent of ferric oxide again increases. Discussing the latter portion of the curve first, it is to be expected from the behavior of the oxides of manganese and copper,<sup>1</sup> as well as from general theoretical considerations, that a high concentration of alkali would favor the formation of the more acidic of the oxides of iron, namely, Fe<sub>2</sub>O<sub>3</sub>. The reason for the increase in ferric oxide content at lower alkali concentrations was not so evident at first, but it probably may be explained as follows: The murky appearance of the melts corresponding to points on the left-hand branches of the curves in Fig. 1 seems to indicate a decrease in the solubility of one of the substances present. The murkiness usually appeared more pronounced when the melts were first made than after prolonged reduction, and in all cases a murky green color was obtained which did not go completely

<sup>1</sup> Bancroft and Nugent: J. Phys. Chem., 33, 481, 729 (1929).

over to black on prolonged reduction, showing that it was not ferrous oxide nor metallic iron which was precipitating. The inference is that the melt was saturated with iron oxides, and that the ferric oxide was less soluble than the ferrous. Such a condition would favor a high total (dissolved and undissolved) content of ferric oxide. Perhaps a more important point is the change in the solubility of the hydrogen, which was much less in the melts of low alkali content than in the other, less viscous ones. The solubility of the hydrogen in the less viscous potash melts was especially marked, a decided effervescence of the gas taking place when the molten mass was stirred with a glass rod. It is significant in this connection that the potash beads were the bluest of all those prepared, and also that they contained a higher percent of ferrous oxide than could be obtained with either sodium or lithium oxide.

When sodium oxide is replaced by calcium, the melt becomes much more viscous and the solubility of the hydrogen is probably diminished. This would account for the rapid falling off in the percent of ferrous oxide indicated in Fig. 2 (a).

It will be observed that in passing from lithium to potassium, the curves in Fig. 1 move successively to the right, and that the maximum concentrations of ferrous oxide obtained are successively lower. It is to be expected that the smaller the amount of the particular alkali required to bring the ferric oxide into a state of complete reactivity, i.e., into solution, the less the reduction to ferrous oxide is retarded *at that point*, for the very reason that the alkali concentration is less. Therefore, as the curves are plotted the higher peaks occur to the left of the lower ones.

Only two points were determined on the lithium curve, besides the one showing the presence of metallic iron, but since it so happened that they showed the curve in its logical position they were considered to be sufficient. The high concentration of lithium oxide required to prevent the formation of metallic iron makes it seem unlikely that the left branch of the curve would be very pronounced.

It is quite likely that for other substances than hydrogen the curves would have the same shape and relative positions, within the limitations of the particular reducing agent used, though their actual positions might be altered.

The observation made during the preliminary experiments that increase of alkali content favored the formation of blue is now explained, for the sodium oxide concentration was being changed over values corresponding to points on the left branch of the curve. Likewise, the puzzling behavior of Rochelle salt as a reducing agent is accounted for. This substance probably was more efficient than other organic substances tried as reducing agents on account of its potassium content, and the reversion of the blue tints to green was caused by passing the optimum alkali concentration.

It seemed quite safe to conclude that the blue color in the borate beads is caused by the presence of ferrous oxide, or of ferrous oxide containing small

amounts of ferric oxide, yellow by the presence of ferric oxide and the various shades of green by mixtures of the two. Whether the iron oxides are in solution *per se* or in combination with the boric oxide has not been settled, but seems unlikely and is immaterial so far as the scope of this paper is concerned. The question then arises as to why the beads containing calcium, magnesium, and zinc oxides are greener than those without, even though they contain a higher per cent of ferrous oxide. It seemed likely that if any of the iron were in combination as ferrite, which probably would be colorless, the extent of such combination would be diminished by the addition of a less alkaline metallic oxide. Such being the case, the result would be an intensification of the yellow imparted by the same amount of ferric oxide. Liberation of ferric oxide from combination also would make it more available to the reducing agent and thereby increase the amount of ferrous oxide formed. Experimental evidence that this is actually the case was obtained by preparing melts containing the same proportion of sodium oxide and boric oxide, but adding calcium oxide to one and not to the other, comparing the colors obtained upon prolonged oxidation. Yellow beads were obtained in each case, but the beads were quite clear from the melt containing no calcium and rather cloudy from the other. The same cloudy appearance could be obtained in the first melt by increasing the iron concentration to 150 percent of its original value. Upon dissolving the beads it was found that the permanganate titres of the solutions were practically zero, showing that the oxidation had been complete.

The experiment was not repeated with zinc or magnesium oxide, but reference to earlier notes taken on the preliminary experiments showed that a similar observation already had been made in the case of zinc oxide. The observation during the preliminary experiments that calcium oxide facilitated the production of a blue coloration is of no consequence in this connection, for the reason that in that case the reducing agent was Rochelle salt.

*Application to Industrial and Natural Products.* Since exactly the same colors have been produced in borate beads as have been observed in glass, and in analogous conditions, it seems logical to extend the theory which has been developed to a consideration of glasses.

One may now explain Thorpe's observation<sup>1</sup> that the color of soda glass is not completely neutralized by manganese oxide unless a small amount of cobalt oxide is added also. Potash produces blue over a much wider range of concentrations than does soda, and it is therefore quite probable that the soda glass is less rich in blue than a corresponding potash glass. The deficiency in the blue of the ferrous oxide is made up by the addition of cobalt oxide, which works just as well since the color neutralization is purely physical.

The theory mentioned by Beckmann that the ancients either used volcanic slags or imitated them in making their blue glasses and glazes is at least possible. According to Wilson,<sup>2</sup> ferrous oxide could exist in the presence

<sup>1</sup> Thorpe: "Dictionary of Applied Chemistry," 3, 387 (1922).

<sup>2</sup> "Ceramics—Clay Technology," 146 (1927).

of sulphur at high temperatures, but ferric oxide could not. If iron oxide were present in the volcanic slag, it would therefore be present in the right form to produce a blue color.

The statement of Bontemps that all the colors in the spectrum may be produced by iron oxide in glass, and that they occur in their natural color as the temperature is increased, is also in accord with the present experiments. Red is produced by a relatively high concentration of ferric oxide, or by ferric oxide in a glass of low alkali content in which the solubility is slight. Decreasing the concentration of ferric oxide or increasing the alkali content of the glass produces orange and then yellow; and upon reduction, which is favored by a high temperature, the yellow changes to green and then to blue. The colors of fired clays may be explained on the same basis.

Referring again to the article by Sir Herbert Jackson, only a partial explanation is found for what he has to say with regard to the specific effects of lithium, zinc, and magnesium oxides in glass. The addition of zinc and magnesium oxides to borate melts increases the proportion of ferrous oxide, but does not produce a blue color. It is possible that in a silicate melt the magnesium and zinc oxides promote both the formation of ferrous oxide and of the blue coloration. He also states that lithium oxide produces a blue color in glass containing iron. He does not state the concentration of the lithia nor what other metallic oxides are present, so the statement is of little significance in the light of this paper. No study has been made of the effect of combining two alkalis, so no prediction is made as to what color would be obtained in such a case. It is possible, however, that by choosing the proper proportions of lithia and other alkali the formation of more ferrous oxide and a correspondingly bluer color would be promoted.

With regard to the variety of red colors which Jackson describes as occurring in lead glasses, an increase in lead content would be expected to produce the same effect as the addition of zinc oxide, namely, a decrease in ferrite formation and also in the solubility of the ferric oxide. This conclusion is in agreement with the effects mentioned.

Before closing this discussion, it might be in order to mention the subject of lapis lazuli and artificial ultramarine in the light of what Sir Herbert Jackson<sup>1</sup> has to say with regard to the color of these materials: "Before leaving the subject of iron I am tempted to hazard a guess at the nature of the colouring matter in lapis lazuli. In almost all the specimens which I have seen, here and there crystals of iron pyrites (ferric sulphide) can be seen." Whether he means iron pyrites or ferric sulphide is not definite, but immaterial. In view of the remainder of the discussion, ferric sulphide is probably the substance referred to. "An examination of these specimens under the microscope reminds me very strongly, except for the difference of colour, of the appearances of many of the glazes very deeply coloured with ferric oxide, in which crystals of ferric oxide can be seen. The colouring of lapis lazuli is very intense, so much so that very thin portions of it make

<sup>1</sup> Nature, 120, 302 (1927).

equally thin portions of the deepest blue glass obtainable look almost white by comparison. Let me for a moment direct attention to a simple experiment with solutions. If to an aqueous solution of ferric chloride, there be added quickly an aqueous solution of hydrogen sulphide, there is the production of a transient intense lapis lazuli colour. It has been suggested that this colour is due to the formation of a ferric sulphide which, in the solution, rapidly breaks down to a ferrous salt with the separation of free sulphur. My guess in respect of lapis lazuli is that the beautiful blue colour is due to minute particles of ferric sulphide, altogether too small to be seen by the microscope, dispersed through the mineral. Different concentrations of the dispersed ferric sulphide would account for the various lighter blues, full blues, and dark, almost black, blues which can be seen in specimens of lapis lazuli. I hope to be able to find a specimen of lapis lazuli of the very blackest blue colour obtainable and to examine it critically by the microscope; I also hope to be able to test the suggestion made by synthetic experiments.

"In the process of making artificial ultramarine by heating together clay, sodium carbonate, sulphur and charcoal, or some other substance rich in carbon, it has been stated, I believe, by a number of experimenters, that small amounts of iron must be present in the materials. I need scarcely mention that almost every clay contains small, but appreciable, quantities of iron."

There is no apparent reason for assuming that ferric sulphide in a mineral would have the same physical appearance, except for color, as ferric oxide in a glaze. Moreover, as has been pointed out previously, there seems to be little logic in reasoning from an aqueous solution to a glass or mineral. Furthermore, ferric salts do not break down to ferrous salts at ordinary temperatures unless a reducing agent is present. It is not the purpose of this discussion to suggest that lapis lazuli owes its color to the presence of ferrous oxide, but merely to point out the discrepancies in the theory quoted. With regard to artificial ultramarine, however, the fact seems worth mentioning that iron is usually considered to occur in clays in the form of the oxide, and it does not seem likely that the oxide would be converted into the sulphide by heating with sulphur. Carbon is a stronger reducing agent, and would be more apt to reduce the oxide to the metal. Green and yellow colors are often obtained in artificial ultramarine, which are in keeping with the behavior of iron oxide. If the sulphur is responsible for the color, it seems more probable that colloidal sulphur is present, the color depending upon the particle size. The whole thing is a matter of conjecture, but there does not seem to be a preponderance of evidence in favor of the theory that either natural or artificial ultramarine owes its color to the presence of ferric sulphide.

These experiments prove conclusively that the blue color produced by iron in the borate beads is not due to dissolved magnetite. Since the blue color increases in purity with increasing relative amounts of ferrous oxide, the obvious conclusion is that dissolved ferrous oxide is blue. On the other hand the experiments do not prove this, because no borate glass has yet been

prepared in which one hundred percent of the iron is present in the ferrous state. The results are consistent with the hypothesis that a small percentage, less than five, of the iron must be present in the ferric state. In most cases this would seem hypercritical; but there are a number of facts which make it necessary to recognize the probability of such a limitation, notably the experiments of McCarthy<sup>1</sup> which will be discussed later.

"Ferrous phosphate,<sup>2</sup>  $\text{Fe}_2(\text{PO}_4)_2 \cdot 8\text{H}_2\text{O}$ , occurs as vivianite or blue iron earth, sometimes mixed with clay and peat or associated with bog iron ore. It may be produced by addition of sodium phosphate to ferrous sulphate. . . . When quite pure it is colourless, but it rapidly becomes bluish or green from oxidation. When iron is dissolved in phosphoric acid the solution deposits colourless needles of  $\text{Fe}(\text{H}_2\text{PO}_4)_2 \cdot 2\text{H}_2\text{O}$  which rapidly alter in air. . . . Crystals [of vivianite] from freshly opened rock cavities are colourless, but on exposure to the air they very soon acquire a greenish-blue tinge, darkening to a characteristic deep indigo-blue. This change in colour is due to a partial oxidation of the iron, which in the black kertschenite ( $\text{Fe, Mn, Mg}$ ) $\text{Fe}^{\text{III}}\text{PO}_4 \cdot 7\text{H}_2\text{O}$ , from the Kerch peninsula, Crimea, is almost complete. Vivianite is the commonest of the several iron phosphate minerals. The best crystals are found in metalliferous veins, *e.g.* at Wheal Jane in Cornwall, with pyrrhotite, and at Leadville in Colorado. Crystals are also found in the interior of fossil shells; *e.g.* in the Kerch peninsula, Crimea; and also sometimes in bones and horns buried in peat deposits. More often the mineral has the form of a blue earthy powder (blue iron-earth), and it is in this form that phosphorus is present in bog iron-ore and other limonite ores of iron."

Mellor<sup>3</sup> merely says that "vivianite,  $\text{Fe}_2(\text{PO}_4)_2 \cdot 8\text{H}_2\text{O}$ , hydrated phosphate of iron, sometimes with a little aluminum, manganese, silica, and organic matter; consists essentially of water and ferrous and ferric phosphate (monoclinic)." In the "blue roots" analyzed by Dudley,<sup>4</sup> the vivianite contained 9.4% ferric oxide and 24.6% ferrous oxide, which is very closely a molecular ratio  $\text{FeO}:\text{Fe}_2\text{O}_3 = 6:1$ . In round numbers three-fourths of the total iron is present as ferrous compound.

There is no necessary parallelism between the color of a hydrated ferrous compound and ferrous oxide in borate beads. We know that hydrated cupric chloride is green and that the concentrated solutions are green; but cupric oxide in borate beads is always blue and never green. The green color, which we can get easily, occurs only when some of the copper is in a lower stage of oxidation. On the other hand, we are not able to say that the blue color of vivianite is necessarily different in principle from the blue color of iron in the borate beads. One would like first to know what percentages of ferric iron change hydrated ferrous phosphate to blue and to green.

If vivianite were an isolated case, one might ignore it; but it is not. Crocidolite is a mineral that would repay further study.<sup>5</sup> Crocidolite is

<sup>1</sup> Am. J. Sci., (5) 12, 17 (1926).

<sup>2</sup> Thorpe: "Dictionary of Applied Chemistry," 3, 682 (1922); 7, 320 (1927).

<sup>3</sup> "A Comprehensive Treatise on Inorganic and Theoretical Chemistry," 8, 734 (1928).

<sup>4</sup> Am. J. Sci., (3) 40, 120 (1890).

<sup>5</sup> Thorpe: "A Dictionary of Applied Chemistry," 2, 421 (1921).

"a mineral of the soda-amphibole group, consisting of sodium and iron (ferrio and ferrous) silicate,  $\text{NaFe}^{\text{III}}(\text{SiO}_3)_2 \cdot \text{Fe}^{\text{II}}\text{SiO}_3$  . . . In the trade it is known as *blue asbestos*. . . . Being an alkali silicate with ferrous iron, crocidolite is especially liable to decomposition when exposed to weathering; sodium is removed, and the iron oxidised and hydrated to form limonite, while the silica is set free. There then results a ferruginous quartz possessing the finely fibrous structure of the original mineral; or, in other words, a pseudomorph of quartz and limonite after crocidolite. This material is colored a rich golden yellow, and displays a silky lustre, and being at the same time very hard, it is well adapted for ornamental purposes. When cut and polished with a convex surface, it displays a cat's eye effect, and it is extensively used for making knobs, umbrella handles, beads, etc. Such material is known as *tiger-eye*, though, unfortunately, in the trade the name crocidolite is very frequently misapplied to it. The name *pseudo-crocidolite* would be more appropriate. In some stones there has been silicification without oxidation, and the indigo-blue colour of the original crocidolite has been preserved : material of this kind is known as *hawk's-eye*."

Cairns<sup>1</sup> reports 21% FeO and 16%  $\text{Fe}_2\text{O}_3$  in a sample of crocidolite that he analyzed, and Wherry and Shannon<sup>2</sup> report 11% FeO and 18%  $\text{Fe}_2\text{O}_3$ , which would not give a blue in the borate beads. It is admitted that crocidolite usually contains titania and part of the blue color may be due to that. It seems probable that not much is to be gained in a matter of this sort by a direct study of natural minerals because of the unknown effect of impurities.

Palache<sup>3</sup> has reported on the existence of a blue soda amphibole near Berkeley. "It has long been known that the crystalline schists of the Coast Ranges of California contain in considerable abundance and widely distributed a blue amphibole, related in many of its characters to glaucophane. . . . In the course of field studies of the crystalline schists in the vicinity of Berkeley this blue amphibole was found to be abundantly present, and quite characteristic of these rocks, and it was thought desirable to make a detailed investigation of the petrographical character of one of its occurrences. For this purpose a rock was selected which contained the mineral in unusually well-developed crystals, quite readily separable from their matrix, and, therefore, very favorably situated for study. . . . Hand specimens of this rock show a distinctly schistose structure, owing to which it splits with great ease into flat slabs. On the surface [of such a slab] are to be seen numerous columnar crystals of the dark blue amphibole, embedded in a milk-white granular matrix, which has much the appearance and structure of granulated sugar, and crushes readily to a crystalline powder under the hammer."

"The blue amphibole appears in the thin sections most frequently in sharply bounded lath-shaped crystals of a fine blue or yellowish blue color. . . . The pleochroism is very strong,  $\alpha$ , sky blue to dark blue;  $\beta$ , reddish to pur-

<sup>1</sup> Am. J. Sci., (3) 34, 108 (1887).

<sup>2</sup> J. Washington Acad. Sci., 12, 242 (1922).

<sup>3</sup> Univ. California, Bull. Dept. Geol., 1, 181 (1884).



plish violet, very dark in basal sections;  $r$ , yellowish brown to greenish yellow, never colorless. Absorption formula,  $a \geq b > r$ ,  $a$  and  $b$  being somewhat variable in the relative intensity of their colors. These colors are in all cases more intense than are those of typical glaucophane from various localities examined by the writer. They approximate in intensity the pleochroic colors of riebeckite."

The blue amphibole was called Crossite after Whitman Cross. The chemical composition is given as:  $\text{SiO}_2$ , 55.02;  $\text{Al}_2\text{O}_3$ , 4.75;  $\text{Fe}_2\text{O}_3$ , 10.91;  $\text{FeO}$ , 9.46;  $\text{MnO}$ , trace;  $\text{MgO}$ , 9.30;  $\text{CaO}$ , 2.38;  $\text{Na}_2\text{O}$ , 7.62;  $\text{K}_2\text{O}$ , 0.27; water undetermined. Such a ratio of ferrous to ferric oxide would not give a blue color in the borate beads. Consequently we must either assume another coloring matter than iron in the blue amphibole, or we must show that the other constituents obliterate the yellow in some way, leaving the blue color.

The only reason for considering that the color might be due to an oxide of titanium is that Louderback<sup>1</sup> has described a blue mineral called benitoite which is apparently essentially a barium silicotitanite,  $\text{BaTiSi}_3\text{O}_{12}$ . "Benitoite forms a beautiful gem stone, but only a small proportion of the crystals are suitable for cutting. It is generally cut as a brilliant to bring out both its color and the brilliancy and fire due to its high refractive power. The deep violet-tinted blue of the finer stones is very attractive, and by many it is considered more beautiful than that of the sapphire, which it surpasses distinctly in fire and brilliancy. The color varies from colorless to very deep blue, the two extremes being the least common. The finest stones are those with a moderately deep color. Considerable judgment has to be used in getting the proper attitude and proportions to bring out the full color-value while preserving the brilliancy. Both color and brilliancy vary materially in different directions and the color is often distributed unevenly or zonally. Quite a number of stones which have been cut by different lapidaries do scant justice to the possibilities of the gem. A common result is the production of a sort of dull leaden, or in the darker varieties blackish appearance."

"The outcrop of the mineralized zone is not very extensive. At its widest point it is about sixty-four feet. Its length is not over four hundred feet. Of this the easternmost part carries barren natrolite veinlets and the wall-rock shows a minimum of metasomatic alteration. Benitoite has been found at the surface along about 230 feet of the zone, and at the extremes of this distance only in very small quantity. . . . The most abundant mineral of the veins is natrolite, which occurs chiefly in granular aggregates. Indications of crystal form are largely limited to the drusy cavities, and even there the natrolite generally forms in peculiar groups, projecting in small roof-shaped ridges or coxcomb-like forms, and only very rarely developing the prismatic forms usually characteristic of natrolite. Some of the druses are filled with very small needles of green or blue-green amphibole, and lying in the midst of the cavity supported by these needles the natrolite often occurs as equant<sup>2</sup>

<sup>1</sup> Univ. California, Bull. Dept. Geol., 5, 331 (1909).

<sup>2</sup> Used in the sense of equidimensional or nearly so, in contrast to tabular or prismatic, as suggested by Cross, Iddings, Pirsson and Washington: J. Geol., 14, 698 (1906).

polyhedral aggregates of from one to three millimeters in diameter, not at all suggestive of the mineral natrolite. Most conspicuous and beautiful, in this white ground of the natrolite gangue are the scattered, idiomorphic crystals of the blue, equant or somewhat tabular, benitoite and the brilliant black neptunite prisms, showing here and there a touch of deep red. These minerals are the characteristic and more abundant minerals of the benitoite-bearing minerals."

The color of the benitoite is "most commonly pale to deep blue, generally with a slight violet tint; transparent. Colorless crystals occur, but are more rare. The variation in color occurs frequently on the same crystal, and the writer has many in which part of the crystal is blue and part colorless. The transition is sometimes gradual and irregular; sometimes it is sharp, the zones being separated by crystallographic planes. The writer has a slab cut parallel to the vertical axis to exhibit the pleochroism in which the line separating the blue from the colorless portion is parallel to that crystallographic axis. On another crystal a colorless layer 2 mm thick lies at the top, and is separated from the bulk of the crystal which is blue by a plane parallel to its base. The physical properties of the colorless material are, except for those dependent on color, the same as those of the most highly colored ones.

"An effort has been made to determine the source of the blue color of most of the material, but the results have so far been negative. Some of the colorless material was separated carefully and submitted to Professor Blasdale for chemical analysis; but it shows but slight variation (if any) from that of the blue, as may be seen by referring to the analyses given farther on. He also made a careful quantitative examination of a two-gram portion, but failed to detect any appreciable amounts of any element that might reasonably be supposed to influence the color of the minerals. That practically all of the titanium is in the highest state of oxidation was also shown by dissolving the material in hydrofluoric acid in an atmosphere of carbon dioxide. A colorless solution was obtained which failed to reduce potassium permanganate. In the preliminary report the writer suggested that the color might be due to a small amount of titanium in the reduced condition in solid solution in the benitoite molecule. A comparison of the analyses of colorless and blue samples shows that the  $TiO_2$  of the former is a half percent or more less than in the latter, and if this can be accepted as an essential difference it at least is in consonance with that view. The violet-tinted blue of the extraordinary ray is also very suggestive of the color given by the sesquioxide of titanium. The reduction test stands opposed to this idea unless the quantity in the material used for the test was very small—or, in other words, unless very small quantities can give distinct colors.

"The color is apparently quite stable. No evidence of fading has been noticed in the cut stones and fragments heated to a bright red, just short of fusion, for five or six minutes showed no change whatever after they were again cooled.

"Pleochroism is very intense in the deep colored varieties and is probably the most important test applicable to cut stones. In the lighter parts the extraordinary ray is a very slightly greenish blue, inclining to indigo as it

becomes darker, and is very similar to one of the axial colors shown by some of the cordierites. In the deeper colored crystals and the thicker layers it is an intense purplish blue. The ordinary ray is white. The color of the mineral in ordinary light is therefore merely the color of the extraordinary ray diluted with the white of the ordinary ray. The extraordinary ray shows strong absorption of sodium light, and renders a determination of the refractive index for that light difficult."

A and B were made on the blue material and C on the white

	A	B	Ave.	C
SiO <sub>2</sub>	43.56	43.79	43.68	43.61
TiO <sub>2</sub>	20.18	20.00	20.09	19.50
BaO	36.34	36.31	36.33	37.01
	<hr/>	<hr/>	<hr/>	<hr/>
	100.08	100.12	100.10	100.12

"The chemical analysis was kindly undertaken by Professor Blasdale. From these is derived the formula BaTiSi<sub>2</sub>O<sub>6</sub>, which yields the following calculated values: SiO<sub>2</sub>, 43.71; TiO<sub>2</sub>, 19.32; BaO, 36.97.

"In an attempt to account for the color of the mineral Blasdale made various qualitative tests, and reports: 'A more careful examination of a two-gram portion of the blue mineral failed to show the presence of appreciable amounts of iron, cobalt, manganese, copper, or chromium. Very minute quantities of sodium and aluminum were obtained, but the amounts were so small as to render it probable that they were derived from the action of the reagents on the glass vessels employed rather than from the mineral itself. Conclusive evidence of the presence of the rarer earths, especially zirconium, tantalum, and columbium, could not be obtained. Careful examination of some of the mineral in a delicate electroscope gave no indications of radioactivity.' It was also shown that all the titanium was present in the higher degree of oxidation. On dissolving the mineral in hydrofluoric acid in an atmosphere of carbon dioxide a colorless solution was obtained which failed to reduce potassium permanganate.

"Benitoite is considered by both of us a very acid titano-silicate. Blasdale notes that the formation of salts of an extremely acidic character is not unusual when the acid concerned possesses very weakly acidic properties and the base very strongly basic ones, also silicon dioxide possesses a remarkable tendency for the formation of complex poly-acids and that it is not improbable that the very closely related titanium dioxide might partially replace it atom for atom in such a compound as the mineral under consideration."

Since neither Louderback nor Blasdale claims that a titano-silicate would be colored and since benitoite is blue at times, it follows Blasdale has either made a mistake somewhere or has overlooked something. An attempt will have to be made to synthesize benitoite or some similar compound, so as to find out what the cause of the blue color is. Until this problem is solved, it will probably be difficult to tell whether an oxide of titanium does or does not play any part in the coloration of vivianite and crocidolite.

The question of the iron silicates is in a very bad way so far as the literature is concerned. According to Mellor,<sup>1</sup> ferrous orthosilicate,  $\text{Fe}_2\text{SiO}_4$ , is light yellow and transparent, becoming opaque and dark brown to black and often iridescent on the surface owing to oxidation. What are said to be ferric silicates vary from green to yellow without any apparent connection with the amount of ferrous iron present. "Bernhardi and Brandes referred to a compact greenish-yellow mineral with an opal-like appearance which they called *chloropal*—from  $\chi\lambda\omega\rho\acute{o}s$  green and opal. The mineral was obtained from Unghwar, Hungary, and was hence called Unghwarite by Glocker; Berthier called a yellow or greenish-yellow variety with an unctuous feel, *nontronite* from Nontron, Dordogne, France, where it was found. Breithaupt called a greenish variety with a soft soapy feel, *pinguite*—fat, it was analyzed by Karsten. It was obtained from Wolkenstein, Saxony. Freiesleben called a liver-brown variety from Halsbrücke, Freiburg, Fettbol; and Krantz, Bergemann, and Church called a grass-green variety *gramenite*—from *gramen*, grass—it was analyzed by Bergemann. Knop described a brownish-yellow imperfectly characterized silicate occurring in cavities in the limburgite of Sadbatch, Kaiserstuhl. It was called *glasurite* in allusion to its occurring in layers glazing the interior of cavities. He described another leek-green variety occurring under similar conditions as *protonontronite*. Hausmann described a fibrous yellow mineral from Antario Pereira, Mines Graes, Brazil as *anthosiderite*— $\acute{\alpha}\nu\theta\acute{o}s$ , flower, and  $\sigma\acute{\iota}\delta\eta\rho\acute{o}s$ , iron. Schuedermann's analysis agrees with the formula  $2\text{Fe}_2\text{O}_3 \cdot 9\text{SiO}_2 \cdot 2\text{H}_2\text{O}$ ; F. W. Clarke gave  $\text{Fe}_4(\text{Si}_3\text{O}_8)_3 \cdot 2\text{H}_2\text{O}$ . Zambonini applied the term *müllerite*—after H. Müller—to a massive yellowish-green mineral from Nontron, Dordogne, France, with a lower proportion of water than chloropal or nontronite; otherwise it resembles this mineral closely. Analyses were also reported by Rammelsberg and by Weibull. The formulae are *müllerite*,  $\text{Fe}_2\text{O}_3 \cdot 2\text{SiO}_2 \cdot 2\text{H}_2\text{O}$ ; and *nontronite*,  $\text{Fe}_2\text{O}_3 \cdot \text{SiO}_2 \cdot 5\text{H}_2\text{O}$ . F. W. Clarke suggests that *müllerite* is ferric metasilicate,  $\text{Fe}_2(\text{SiO}_3)_2 \cdot 2\text{H}_2\text{O}$ . Since the name *müllerite* had been given previously for another mineral, M. Bauer proposed the term *zamboninite*. Katzer described a green, granular or scaly, earth from Kritz, Bohemia; it was named *hoeferite*—after H. Hofer. It resembles chloropal or nontronite closely. Its composition approximates  $\text{Fe}_2\text{O}_3 \cdot 2\text{SiO}_2 \cdot 3\text{H}_2\text{O}$ . Katzer said that *hoeferite* is the purest, yet known, ferric hydrosilicate, occurring naturally."

Everybody knows that anhydrous and hydrated salts do not necessarily have the same color. Cupric sulphate and cupric chloride are good instances of this, to say nothing of cobaltous chloride. It is quite possible that a glass may have a different color from the crystals of the same composition. Granting these and other difficulties, it does seem as though somebody should have developed a working hypothesis to account for the green color in some of these minerals.

<sup>1</sup>"A Comprehensive Treatise on Inorganic and Theoretical Chemistry," 6, 906-922 (1925).

There are also difficulties in regard to forsterite,  $Mg_2SiO_4$ , and fayalite,  $Fe_2SiO_4$ , which form a continuous series of solid solutions, the solid solutions, which have always oxidized somewhat, being called olivines.<sup>1</sup> Mellor says that "forsterite may be white, yellowish-white, greyish-white, and it sometimes becomes yellow on exposure to the air, owing to the oxidation of the 'ferrous' iron. The white and colourless crystals—e.g. those from Vesuvius—have been also called *white olivine* or *white peridot*. The ferrous oxide in the published analyses of forsterite ranges from 0.22 up to 4.56 per cent; with higher proportions, the mineral passes into chrysolite or olivine. There is, however, no sharp line of demarcation. It would appear as if fayalite,  $Fe_2SiO_4$ , and forsterite,  $Mg_2SiO_4$ , are the terminal numbers of a continuous series of solid solutions."

Spencer, in Thorpe's Dictionary, says that olivine is "an abundant rock-forming mineral consisting of magnesium orthosilicate with variable amounts of ferrous orthosilicate,  $(Mg,Fe)_2SiO_4$ , crystallized in the orthorhombic system. The member at the magnesium end of this isomorphous series is known as *forsterite* ( $Mg_2SiO_4$ ), and that at the iron end is called *fayalite* ( $Fe_2SiO_4$ ). The latter is a common constituent of crystalline iron slags. Distinctly formed crystals of olivine are of rare occurrence; granular masses are more common. The color ranges from pale yellowish-green to brown, depending on the amount of iron present. . . . The only direct practical application of olivine is as a gemstone; the clear transparent stones are yellowish-green (*chrysolite*) or rich olive-green (*peridot*) in colour; ferrous oxide about nine percent for gem varieties."

If the green of the peridot is really yellow and blue, as it must be, there should be a blue olivine, though it would probably be called something else if there were. So far we have been unable to find any record of such a mineral and yet it must be possible to make it in the laboratory, even if no one ever has.

We can now discuss the work of McCarthy<sup>2</sup> which is of great importance. McCarthy's general thesis is that "the natural iron yellows, browns, and reds are produced by ferric compounds, that the natural iron blues are always produced by *hydrous* ferro-ferric compounds, that anhydrous ferro-ferric compounds produce nothing but grays and blacks, that neutral iron greens seem in all cases to be mixtures of a blue and a yellow molecule, that natural iron purples are of two sorts, a so-called purple which is really a chocolate-red and produced by hematite alone, and a true purple due to a mixture of red and blue substances, and finally, that pure ferrous minerals must be colorless."

By ferro-ferric McCarthy does not mean a magnetite composition; he merely means that both ferrous and ferric compounds of iron are present in the material. That is perfectly legitimate; but he also insists on limiting his cases to natural minerals, which simplifies matters; but which destroys the theoretical value that his work would have had if he had had the courage to

<sup>1</sup> Thorpe: "Dictionary of Applied Chemistry," 4, 703 (1922); Mellor: "A Comprehensive Treatise on Inorganic and Theoretical Chemistry," 6, 384 (1925).

<sup>2</sup> Am. J. Sci., (5) 12, 17 (1926).

face things as they are. The blue borate and silicate glasses do not fit into his scheme and he excludes them because they are not found in nature. One difficulty with the natural clays and other minerals is that the presence of impurities may throw the results out.

McCarthy arranges the materials in the order of increasing values of the ratio of ferrous to ferric content and finds that the substances are mostly red or yellow when the weight percentage of ferrous oxide is not over one half the value for the ferric oxide, while the substances are mostly blue or green when the ratio lies between 0.5 and 0.9. The difficulty is that he does not distinguish between blue and green, and the ratios for blue compounds are not consistently above those for green compounds. He has trouble also with the higher ratios. "At ratios higher than 0.9 hardly anything but blacks are found. At first sight this seems to indicate that ferrous minerals containing little or no ferric iron are black; but since it may be shown that black clays, shales, and slates always contain considerable organic matter, the inference is that the color is due to these carbonaceous impurities, the high degree of ferrousness being a result of the reducing action of this organic matter."

This is undoubtedly the true explanation; but it would have helped matters if he had shown, in one case, that the minerals were blue when the black material is eliminated. Fortunately we have shown that we get a beautiful blue color with the potassium borate bead when the ratio of ferrous iron to ferric iron is 10:1.

The experiments on the color changes when a given mineral is oxidized are very good. The change should be from blue through green to yellow or red. "Watson's experiment<sup>1</sup> of grinding a pale-coloured specimen of natural vivianite was repeated, a light blue fragment being taken. After a few seconds grinding, the mineral became much deeper in hue and qualitative tests indicated that the relative percentage of ferric iron was increasing. Upon further grinding the color grew still deeper, then changed to a greenish blue, then to a muddy green, to a greenish yellow, and finally assumed a dirty but decided yellow hue. Grinding produced no further change and qualitative tests now showed that almost all the ferrous iron had been oxidized. Exactly similar results were obtained with artificial ferrous phosphates and silicates. That these color changes were produced by oxidation was shown not only by an increase in ferric and a decrease in ferrous iron, but by the fact that, when carried out in an atmosphere of carbon dioxide, the color changes were much retarded. Failure to inhibit them totally might have been due either (a) to a change in the valence of iron even out of contact with oxygen, or (b) to air occluded in the mineral.

"Spring's experiments<sup>2</sup> were also repeated, ferrous silicates being made by reaction between sodium silicate and various ferrous salts. In every case where great care was taken to exclude all oxygen the newly formed precipitates were practically colorless, changing rapidly to a deep blue, then to a

<sup>1</sup> Watson: *Am. Min.*, 3, 159 (1918).

<sup>2</sup> Spring: *Rec. Trav. chim.*, 17, 202 (1898).

green, and finally to a yellow. These changes were accelerated by heat, by stirring with a spatula, and by exposure to a current of air, and were retarded by the exclusion of air in a tightly stoppered flask. Similar results were obtained by substituting such compounds as phosphates, borates, aluminates, etc., for the silicate. In other trials using oxalates, acetates, etc., no blue colors were formed, the production of such colors apparently being dependent upon the formation of the ferro-ferric compound."

McCarthy has also quantitative data to show that the weight ratio of ferrous oxide to ferric oxide for the deepest blue varies with the nature of the anion. "Preliminary non-quantitative experiments showed that blue and green iron compounds could be produced in three different ways, viz: (a) partial oxidation of ferrous substances; (b) partial reduction of ferric substances; and (c) direct precipitation from solutions containing both ferrous and ferric iron were prepared, an excess of the precipitating agent added, and the color of the resulting precipitate noted. In the case of the cyanides, ferrous sulphate was run into a potassium ferricyanide solution and changes in color with the successive addition of successive portions of the sulphate recorded. Cyanides were experimented upon not because they were considered analogous to natural minerals, but because the same laws of color change appeared to apply to them as applied to the silicates and because their colors are very intense and not liable to quick changes through oxidation." The results of these experiments are given in Table III.

"It may be noted that while the correlation of ferro-ferric ratio is almost the same for phosphates and silicates, . . . yet for the cyanides the ratio for any given shade is only about one-tenth as great as with either the phosphates or silicates. This simply illustrates that the cyanide colors are about ten times more intense than the other, and hence require ten times the dilution to bring them down to a given shade."

The view expressed in the preceding sentence is debatable to say the least. In general, however, our results and our conclusions check those of McCarthy except the point that a blue iron compound must be hydrous. Since blue borate and blue silicate glasses have been made, which owe their color to iron, this conclusion of McCarthy's is necessarily wrong and the interesting question is where and how he went astray. To answer this we must consider McCarthy's line of reasoning.

"Since in almost every case experiments show that oxidation of iron-bearing materials promotes color changes running from the blue toward the red end of the spectrum, it might be expected that reduction would reverse this color sequence. Ferric silicates, ferric phosphates, oxidized chlorites, red clays, red sandstones, red and yellow soils, red slates, and other similar substances were placed in the tube furnace and heated in a stream of illuminating gas. In no case was a blue or a green color developed, the materials without exception becoming gray or black, although one or two of the clays gave a greenish-black streak rather like that given by pyrite. Exactly similar results were obtained by substituting hydrogen for illuminating gas.

TABLE III

## Colors produced at Varying Ferro-Ferric Ratios

- A ferric and ferrous ammonium alum with sodium ammonium phosphate  
 B ferric and ferrous ammonium alum with sodium silicate  
 C potassium ferricyanide with ferrous sulphate  
 R. ratio of FeO to Fe<sub>2</sub>O<sub>3</sub> by weight

R	A Color	B Color	R	C Color
0.1	pale yellow	pale yellow	0.01	greenish yellow
0.2	pale yellow	pale yellow	0.02	yellowish green
0.3	pale yellow	greenish yellow	0.03	green
0.4	greenish yellow	green	0.04	green
0.5	green	bluish green	0.06	blue-green
0.6	greenish blue	greenish blue	0.10	blue-green
0.7	slightly greenish blue	blue	0.12	green-blue
0.8	blue	blue	0.13	green-blue
0.9	blue	blue	0.14	green-blue
1.0	blue	blue	0.16	blue
2.0	paler blue	paler blue	0.22	blue
5.0	paler blue	paler blue	0.28	deep blue
10.0	pale blue	very pale blue	0.45	deeper blue
20.0	very pale blue	exceedingly pale blue	1.25	deep blue
40.0	almost colorless	almost colorless	12.0	pale blue
∞	colorless	almost colorless	12.0	pale blue
			25.0	very pale blue
			50.0	exceedingly pale blue

"This experiment showed that something beside the simultaneous presence of ferric and ferrous iron was needed to produce greens and blues. Had ferrous and ferric compounds existed as such in the reduced material they should not have turned black, for ferrous salts are always light colored and ferric are red or yellow. The black color did not appear to be caused by metallic iron or magnetite, for tests with a horse-shoe magnet showed no magnetic particles present.<sup>1</sup> In order to discover if the dehydration incident to the heating was the factor preventing the development of blues and greens, wet reduction was tried, both the zinc-and-sulphuric acid method and the stannous chloride method being used. These methods cannot well be applied to such insoluble and stable substances as the majority of rocks and minerals, but all of the artificial salts tested gave the same results. Complete reduction was not obtained in all cases, but what color change as did occur was always in the direction of red to blue. These changes are summarized in Table IV.

<sup>1</sup> Robinson and McCaughey: Bureau of Soils, Bull. 79, 22 (1911) state that the soils tested by them almost invariably became magnetic. It may be that these investigators carried reduction further than was done in the present series of experiments.



TABLE IV

Material	Color Changes during Wet Reduction		
	Original color	Color assumed	Final color
Potassium ferrocyanide	pale yellow	deep green	strong blue
Ferric borate	brownish yellow	good green	blue
Ferric phosphate	yellow	green	blue
Ferric silicate	brownish yellow	green	green

These tests would seem to indicate that water in some form or other is essential in the development of greens and blues in many, if not all, iron compounds, and that loss of color would probably follow simple hydration."

A series of experiments was made to test this last suggestion. "Blue iron-silicates, phosphates, borates, aluminates, and natural vivianite were placed in the tube furnace and heated in a stream of carbon dioxide. These few substances were chosen since it was desired to obtain dehydration at temperatures below 300°, the limit of the tube furnace. In all cases the substances experimented on became gray or black. When oxidized they assumed the same characteristic as did similar materials which were oxidized without previous dehydration.

"A repetition of this experiment, using nitrogen in place of carbon dioxide, gave exactly similar results. It therefore seems necessary to consider that water is essential for the development of blues and greens by ferro-ferric compounds, all blue or green substances of this type which were experimented upon losing their color upon dehydration. It should be noted that compounds analogous to the three types of iron-bearing minerals which are most often blue or green were among those experimented upon. Thus amphiboles, pyroxenes, etc., are silicates, blue spinel is an aluminate, and vivianite is a phosphate."

The flaw in the reasoning seems to be that McCarthy was studying granular material and did not take into account the color changes due to sintering. Haematite is black but gives a brownish-red streak. Rouge is red by name and finely divided ferric oxide is yellow. If one tries to get the last traces of water out of the yellow ferric oxide by moderate heating, the product turns red; but the presence of water is not essential to the yellow. Under suitable conditions which prevent agglomeration, one can heat the yellow oxide without its turning red, as in the case of yellow bricks.<sup>1</sup>

Copper oxide, as we ordinarily know it, is black; but finely divided cupric oxide is blue. Schenck<sup>2</sup> showed this by precipitating cupric oxide in presence of a large excess of alumina. We have just learned that much the same thing occurs in nature. Genth<sup>3</sup> considers that letsomite owes its blue color to cupric oxide of which it contains nearly fifty percent. "The Arizona

<sup>1</sup> Keane: *J. Phys. Chem.*, 20, 734 (1916); Scheetz: 21, 570 (1917).

<sup>2</sup> *J. Phys. Chem.*, 23, 284 (1921).

<sup>3</sup> *Am. J. Sci.*, (3), 40, 119 (1890).

mineral forms narrow seams in a siliceous gangue, coated with earthy varieties of limonite. The lettsomite occurs in incrustations up to a thickness of about 2 mm. In small cavities it shows thin films and small tufts with a radiated structure. Its color is from a deep sky-blue to azure, luster silky. Specific gravity taken in alcohol 2.737.

"Some of the lettsomite has undergone an alteration, beginning with a change into greenish yellow, and finally, by the loss of the cupric oxide, into a fibrous yellowish white material. At portions where the alteration has taken place, the matrix is frequently coated with a cryptocrystalline, mammillary hydrous aluminum sulphate. Neither could be obtained in a quantity sufficient for a fuller investigation."

"The analyses were made with almost pure azure-blue tufts and with nearly pure sky-blue radiating particles. The mean of three analyses was: Insoluble, 0.44; H<sub>2</sub>O, 21.80; SO<sub>3</sub>, 12.49; CuO, 46.71; Al<sub>2</sub>O<sub>3</sub>, 16.47; Fe<sub>2</sub>O<sub>3</sub>, 1.34. Assuming a slight loss of cupric oxide by beginning oxidation, this corresponds quite closely to a formula Al<sub>2</sub>O<sub>3</sub>.SO<sub>3</sub>.4CuO.8H<sub>2</sub>O, which calls for 49.23% CuO. Analysis of a sample of lettsomite from Utah gave a value for cupric oxide of 49.54."

Genth assumes that the color is due to copper oxide because the sulphate stays with the alumina and the cupric oxide. It would be possible, however, to write the formula  $3\text{CuO}.\text{CuSO}_4.4\text{H}_2\text{O}.\text{Al}_2\text{O}_3.2\text{H}_2\text{O}$ , in which case the color would be due to the basic copper sulphate. The best way to determine this point would be to treat a synthetic lettsomite with dilute caustic soda until all the sulphate was removed, and to determine what change, if any, occurred in the color of the sample.

Dudley<sup>1</sup> reports that vivianite becomes green if dried at 100° or in a desiccator over sulphuric acid, and light brown if heated to 260° until all of the water is eliminated. The green is of course the result of oxidation, which must have occurred to a greater extent at a higher temperature.

In view of what is known in regard to the behavior of yellow ferric oxide and blue cupric oxide, it seems reasonably certain that the change to black or gray, observed by McCarthy was the result of an agglomeration. Of course, with a granular material there is always the possibility of the formation of a certain amount of black magnetite. This possibility seems not to have occurred in McCarthy's experiments; but it did in those of Robinson and McCaughey.

The experiments of McCarthy and of ourselves establish the fact that one gets a good blue in iron-bearing minerals only when the iron is present partially in the ferrous state and partially in the ferric state. The ratio of FeO to Fe<sub>2</sub>O<sub>3</sub> for a good blue varies very much with the nature of the acid radical and with the other constituents present. It is 0.45 for the cyanide, 0.6-1.3 for crocidolite, 0.9 for the phosphate, 2.6 in Dudley's vivianite, and 7.8 in another sample; the ratio may certainly run up to 19 in the borate

<sup>1</sup> Am. J. Sci., (3) 40, 121 (1890).

beads. The theoretical ratio for magnetite is about 0.45. There is no evidence for magnetite as such playing any part in the phenomenon and there is also no evidence for the existence of any definite blue compound.

McCarthy does not venture to write a formula for a blue ferro-ferric compound; but he apparently believes that there are several. In the table of natural products given by McCarthy, no unquestioned green occurs with a ratio less than 0.7; but this is because he does not include glauconite which may be green with a ratio of 0.08. This brings out a rather elaborate explanation.

"All iron salts which are of a decided blue color may be shown to contain both ferric and ferrous iron in the same molecule,<sup>1</sup> an intensive search of chemical literature having failed to reveal a single exception to this rule. The work of Spring,<sup>2</sup> as well as the present series of experiments has shown the rule to hold strictly true for the silicates and also for the borates, aluminates, and phosphates of iron. Analyses of natural minerals bear this out also, for in Table I [not reproduced in this article] we find such diverse materials as vivianite, crocidolite, vesuvianite, glaucophane, indicolite, limestones, clays, shales, and slates of various shades of blue, and all containing both ferrous and ferric iron. Since the mixture of ferrous and ferric solutions between which no reaction takes place, seems never to give rise to a blue color, and since the addition of a proper precipitant to such a mixed solution will invariably throw down a blue precipitate provided an excess of ferric iron is not present, it appears certain that these blue iron compounds are not mere mixtures of ferric and ferrous salts, but true ferro-ferric compounds.

"The most generally accepted explanation of the blue color often found in clays is that such a color is produced by finely disseminated organic matter,<sup>3</sup> the basis for this belief apparently being the general occurrence of organic matter in such blue clays. But since Table I shows that the ferro-ferric ratio of such clays falls in line with that of many other blue substances which contain no organic matter, there seems little doubt but that it is the iron rather than the organic matter which is responsible for the blue color, the latter type of material probably serving merely to prevent further oxidation of the iron.

"In every experiment where a seemingly green iron compound was produced, ferric iron was present in excess, this being true whether the green was produced by reduction of a ferric compound, by oxidation of a ferrous salt, or by precipitation from a mixed solution. Mixtures of ferrous sulphate and potassium ferri-cyanide solutions vary from a deep blue (no excess ferric iron) to a bright green (ferric iron in excess), there being a gradual change in color with no discontinuities. This would indicate a mixture of two compounds rather than the formation of a third, for the production of a third (green) compound would have, in all probability, introduced discontinuities

<sup>1</sup> Hofmann and Resenscheck: *Ann.*, 342, 364 (1905).

<sup>2</sup> Spring: *Rec. Trav. chim.*, 17, 202 (1898).

<sup>3</sup> Ries: "Clays; their Occurrence, Properties and Uses," 161 (1906); Pirsson: "Rocks and Rock Minerals," 227-228 (1915).

in the color sequence. It will also be recalled that spectroscopic evidence points in the same direction, the absorption of superimposed blue and yellow cyanide solutions being exactly like that produced by an actual mixture of the two.

"It seems impossible to prove beyond a doubt that the green color of such minerals as chlorite is not due to the actual presence of a green molecule but rather to the simultaneous presence of blue and yellow molecules, although the writer believes this to be the case. Since visual blue contains much visual yellow, superposition of blue and yellow color filters will invariably give a green which cannot be distinguished from a 'single color' green. There was no evidence found in favor of a green iron-bearing molecule, and the only strong argument against it seems to be the presence of green minerals both of rather high and rather low ferro-ferric ratios. This objection can, however, be met.

"The ferro-ferric ratios employed in this study were taken from general analyses which showed only the total amount of ferric and ferrous iron and said nothing as to their forms of combination. Thus a ferro-ferric phosphate might well have the same ratio as a mixture of ferrous siderite and ferric hematite and yet only in the former case would a ferro-ferric compound be present. Remembering that purely ferrous compounds are colorless and that ferric compounds are usually yellow, we may postulate, in the case of a high-ratio green mineral the simultaneous presence of a colorless ferrous compound, a blue ferro-ferric compound, and a yellow ferric molecule. The first mentioned would account for the high ratio and the two latter ones for the color. That such mixtures may be the rule rather than the exception is indicated by the generally accepted belief that green minerals are colored by ferrous iron.

"In the same manner we may explain the presence of a few green *ferric* minerals which appear on our lists. A case in point is glauconite, long considered a ferrous mineral on account of its green color. It is, on the contrary, highly ferric, although ferrous iron seems always to be present. The average of six different analyses<sup>1</sup> gives 23.5%  $\text{Fe}_2\text{O}_3$  and 1.93%  $\text{FeO}$  (ratio = 0.08). Here we have doubtless to do with a very small percentage of an intensely blue ferro-ferric compound and a much larger percentage of a rather pale yellow ferric compound."

While McCarthy does not actually say that the intensely blue ferro-ferric compound of the preceding paragraph is different from the ferro-ferric compound of the preceding paragraph which was blue but not intensely blue, he certainly implies this if he is choosing his words carefully, and one must assume that until evidence to the contrary is brought forward. This means the assumption of at least one hypothetical blue compound, probably of two, and possibly of more. This should not be done unless and until it is absolutely necessary.

<sup>1</sup> Collet: "Les dépôts marin," 165 (1908).

It seems to us that the facts can be accounted for better and more easily on the assumption that ferric oxide or a ferric salt can occur in two modifications, a yellow and a blue, the blue modification being stabilized by ferrous oxide or by a suitable ferrous salt. This stabilization will be affected by the acid radical and by the other components, which may account for the wide variation in the value of the ratios required to give a good blue or a good green. There is nothing startling about this. Stillwell<sup>1</sup> showed that there are red and green forms of chromic oxide, and that the red form is stabilized by alpha alumina, thereby accounting for the color of the ruby. In alumina, chromium oxide will stay red up to a concentration of over thirty percent. In glass around one percent is the limiting concentration for the red modification, and in the emerald mixture the red form has not yet been stabilized at any concentration. The effect of zinc oxide on the blue color of iron in glass<sup>2</sup> may perhaps come under this head. The differences in the ratios for blue or green with different minerals would then depend on the different relative amounts of the hypothetical stabilizing agents. It is evident that this hypothesis may account for all the observed facts. A great deal of experimenting will have to be done before one can be certain that it actually does account for them.

A. LeChatelier<sup>3</sup> has prepared a blue glass with chromic oxide in the presence of zinc oxide. This is apparently a case of stabilization at low concentrations, and we have green chromic oxide as the stable form, red chromic oxide as the less stable form, and blue chromic oxide as the least stable form. LeChatelier also prepared a pink glass with cobalt; but he gives no details in regard to this. Berzelius found that magnesia is colored pink when heated with cobalt salts. Hedvall<sup>4</sup> crystallized cobaltous and magnesium oxides from a fused potassium chloride bath and obtained a continuous series of solid solutions, varying from colorless at the magnesia end, through pink, to red at the cobaltous end. This indicates that the red form of cobaltous oxide is the stable one and that the blue which we associate with cobalt is the instable form, just as is the red chromic oxide. With cobaltous oxide and zinc oxide Hedvall obtained a partial series of solid solutions, Rinmann's Green. Since the properties of an isodimorphous series are believed to be practically additive, the cobaltous oxide in Rinmann's Green must be green if the zinc oxide is considered colorless and must be blue if the zinc oxide is assumed to be yellow. Hedvall rejects this latter assumption, which was suggested by Rinmann in 1780, on the ground that zinc oxide is yellow only heated and that there is no especial yellow modification. This is not conclusive. If cobaltous oxide strains the zinc oxide lattice in the same way that heating does, it will make it yellow. For the moment this is not important. We certainly have a red and a blue cobaltous oxide and we may have a green one. The general behavior is like the chromic oxide and like the ferric oxide.

<sup>1</sup> J. Phys. Chem., 30, 1441 (1926).

<sup>2</sup> Sir Herbert Jackson: Nature, 120, 266 (1927).

<sup>3</sup> Compt. rend., 127, 433 (1898).

<sup>4</sup> Z. anorg. Chem., 86, 201, 296 (1914).

Since cobaltous oxide can be made to give a green with alumina and with stannic oxide, it is probable that there is a green cobaltous oxide.

Hofmann and Höschele<sup>1</sup> confirmed Hedvall. They fused anhydrous cobalt sulphate with dry magnesium chloride at about 800° and obtained beautiful pink crystals, octahedra and octahedra with cube faces, which analyzed about 13.6% CoO and 86.7% MgO. In presence of magnesia, the composition of the crystals varied continuously.

Nearly twenty-five years ago, Hofmann and Resenscheck<sup>2</sup> advanced the theory that a combination of ferrous and ferric was essential to the production of blue. They were discussing primarily Prussian blue, etc; and they say: "The cause of the basal blue color can only depend on the one condition which is common to all compounds of this class, that ferric iron is combined with ferrocyanogen. Compounds of divalent or trivalent iron with cyanogen or with complexes containing cyanogen are not necessarily colored; with potassium ferrocyanide and a ferrous salt, with potassium ferricyanide and a ferric salt, or with potassium cobalticyanide and ferrous or ferric salts, one does not get intensely colored precipitates at once. The necessary condition for intense absorption of light and consequently for a characteristic coloration is the presence of *divalent and trivalent iron in the same molecule*.

"For instance, if we combine ferrous atoms with ferric atoms by means of oxygen instead of by means of cyanogen, we obtain a substance which absorbs light even more completely than any of the Prussian blues, the long-known *Aethiops martialis*, which exceeds its components, ferrous hydroxide and ferric hydroxide, in color intensity by at least as much as the blue ferrocyanides exceed the color intensity of their components, namely potassium ferrocyanide and ferric salts.

"This way of looking at things becomes of more general interest when we recall that surprisingly similar relations occur with quite different elements. The intensely red-colored minium contains divalent and quadrivalent lead combined with oxygen. It is to be considered as lead plumbate and can, according to Frémy,<sup>3</sup> be obtained as a yellow precipitate by mixing a solution of colorless potassium plumbate. When the yellow precipitate loses water, it changes to an intensely red color.

"The faintly yellow sulphur combines, when heated slightly with colorless sulphur trioxide to form the deep indigo-blue S<sub>2</sub>O<sub>8</sub>, in which the sulphurs are unquestionably in different states of oxidation.

"Our conclusions harmonize with the opinions which A. Werner<sup>4</sup> uttered in connection with his investigation of the platinoxalates, which are surprisingly colored in case they contain divalent and tetravalent platinum in the same molecule. He says: 'It cannot be denied that when working with the platinoxalates one is reminded involuntarily of the quinhydrone which are

<sup>1</sup> Ber., 48, 26 (1915).

<sup>2</sup> Ann., 342, 364 (1905).

<sup>3</sup> Ann. Chim. Phys., (3) 12, 499 (1837).

<sup>4</sup> Z. anorg. Chem., 12, 53 (1896).

made from relatively weakly colored compounds and yet occur in intensely colored, often cantharides-yellow, brilliant crystals. An equally appropriate case is furnished by the platinum compounds with the tungsten-bronzes. As everybody knows, these last are usually made by letting a certain number of tungstate molecules combine with one molecule of a tungstite. These are characterized by richness of color.<sup>1</sup>

"The number of such cases can be increased by reference to the brown-black porcelain color, uranous uranate,  $U_3O_8$ ; to the intensely blue molybdanic molybdate,  $Mo_3O_8$ ; and to the deep reddish-brown bismuthous bismuthate,  $Bi_2O_4$ .

"On the basis of the modern views on the adsorption of light and on the nature of valence it is a simple matter to explain why the combination of different oxidation stages of the same element in a single molecule produces a marked coloration."

This hypothesis by Hofmann and Resenscheck does not get beyond the simple fact that one gets a blue color when one has ferric and ferrous combined in the same molecule. It does not treat the whole question of blue to green to yellow and it apparently cannot account for the variable ratio of ferrous oxide to ferric oxide, a phenomenon of which Hofmann and Resenscheck were ignorant. It was the juxtaposition of the two states of oxidation as such, which Hofmann and Resenscheck considered important, and the possibility of the formation of an instable form never occurred to them and probably could never have occurred to them. As a matter of fact their point of view has not been helpful experimentally during nearly a quarter-century.

As the matter appears to us, dissolved ferric oxide is yellow and so is finely divided ferric oxide. Coarser ferric oxide is red. Some ignited ferric oxide is purple and we do not know whether the purple is or is not due to a slight break-down of the ferric oxide. Coarse magnetite is black. Nobody knows what color finely divided magnetite is. There is no evidence as yet of magnetite existing as such dissolved in any melt. Ferrous salts tend to be colorless. The blue of iron salts is always due to the simultaneous presence of iron in the two ordinary states of oxidation. The greens are due to a mixture of blue and yellow. The ratio of  $FeO$  to  $Fe_2O_3$  for a good blue may vary with the nature of all the substances in the system.

The black luster of the Greek and Roman pottery was due to magnetite in suspension made blacker by the presence of some manganese which was present in the natural ore.<sup>1</sup> "Many of the natural obsidians, which appear black, consist of a colorless matrix swarming with specks of magnetite. If there is complete oxidation to ferric oxide, the color is red. Holden has described quartz crystals which are colored pink by small amounts of suspended hematite. They are not rose quartz. Carnelian is chalcedony containing globules of hematite. If the amount of dispersed material is sufficient to make the mass opaque, we have jasper, which is red with hematite, yellow with limonite, and green with saponite or chlorite. Jasper may contain up

<sup>1</sup> Bancroft: "Applied Colloid Chemistry," 441 (1926).

to twenty percent suspended material. The color of citrine is due to yellow ferric oxide."

Up to this point McCarthy and ourselves are in entire agreement. We differ as to the explanation of the blue color. McCarthy apparently believes that there are several ferroferric compounds which are blue, while we have found no evidence of any definite compound either in our work or in that of McCarthy. We believe that there is a blue modification of ferric oxide which may be stabilized by ferrous salts or by other constituents of the blue material.

Hostetter and Sosman<sup>1</sup> have studied the effect of ferric and ferrous oxides on the color of glass. They never got beyond the green stage and consequently concluded that ferric iron generally gives a yellowish tint and ferrous iron produces green. "When ferric oxide is heated *in vacuo* it gives off oxygen. The relations<sup>2</sup> between oxygen pressure, temperature, and composition have been investigated. As oxygen is evolved, an equivalent amount of ferrous oxide is formed, which in all probability dissolves in the ferric oxide to form a solid solution. . . . The formation of ferrous oxide under these conditions—by dissociation—is to be distinguished carefully from the reduction of ferric oxide by such constituents of furnace gases as carbon monoxide and hydrocarbons. These gases not only dilute the oxygen, thereby lowering its partial pressure, but they remove oxygen from the already reduced ferric oxide and combine with it chemically, thus increasing the amount of ferrous oxide. The formation of ferrous oxide by dissociation in the first case takes place under what are ordinarily considered to be oxidizing conditions. In fact, it has been shown that ferric oxide loses weight, with attendant formation of ferrous oxide in one atmosphere of oxygen at 1300° . . .

"Certain qualitative results obtained by Kinnison may be mentioned here. As far as we know, they are the only results recorded which have been obtained under oxidizing conditions. He subjected four different clay mixtures containing five percent ferric oxide to high temperatures under oxidizing conditions (air) and noted the colors of the slabs after exposure to a definite temperature for 1.5 hours. At 1100° all of the ignited specimens were red, At 1200° one of the tests yielded greenish brown glass, while the other three varied from cream color to pink. At 1400°, the maximum temperature, another mixture yielded a black glass and the other two were black in color but not vitrified. As the temperature was increased from 1100° it was evident that reduction of the ferric iron causing the initial red color had taken place and that the ferrous iron so formed was responsible for the darkening in color. . . .

"It can also be shown readily enough that ferric oxide dissolved in glass loses oxygen at higher temperatures, even under the oxygen pressure of the air. This is evidenced not only by the change in color of the glass from yellow to green, as the glass is fired at successively higher temperatures, but also by actual chemical analysis. . . . In the first series, the glass used con-

<sup>1</sup> J. Am. Ceramic Soc., 4, 927 (1921).

<sup>2</sup> Sosman and Hostetter: J. Am. Chem. Soc., 38, 807, 1188 (1916).



sisted of diopside ( $\text{CaSiO}_3 \cdot \text{MgSiO}_3$ ) to which was added eight percent of iron as ferric oxide, and the equivalent amount of silica to make ferrous silicate. . . . We may note here that the glass fined at about  $1400^\circ$  contains approximately twenty percent of the total iron in the ferrous condition; the color of this glass is decidedly brown. At  $1589^\circ$ , however, no less than forty-one percent of the total iron is ferrous and the color is green. Between these two extremes the color varies from brown through olive green to clear green. . . .

"Since the amount of dissociation increases with temperature, it is obvious that the higher the temperature at which an iron-bearing glass is fined the greener the color. And also it follows that more decolorizer is required for a glass fined at the elevated temperature than at a lower temperature."

The difficulty with the assumptions of Sosman and Hostetter in regard to color is that they do not account for a possible blue color. Since LeChatelier<sup>1</sup> had made a blue glass with iron and since blue bricks are an article of commerce, it is unfortunate that Sosman and Hostetter ignored the question of a blue color due to iron.

It is interesting to note that Napier<sup>2</sup> had an explanation over eighty years ago which does not differ very much from the one that we are advocating. "When a solution of gallic or of tannic acid, which are colourless, and generally form colourless salts or of the colour of the basis, is poured into a solution of the persulphate of iron [ferric sulphate], an intense blue precipitate is formed, which remains suspended in the liquid. This anomalous fact has frequently excited the attention of chemists; M.M. Berzelius and Chevreul have expressed some doubts respecting the simplicity of the reaction.

"It has long been known that tannin and gallic acid do not precipitate the protosalts of iron [ferrous salts] when protected from contact with the atmosphere. Berzelius, Chevreul, and Persoz, have, moreover, observed that when gallic acid or tannin is conveyed into a salt of the peroxide of iron, it is always reduced to the state of a protosalt. This fact is easily proved by adding to the blue solution produced by the persulphate of iron in a solution of gallic acid an excess of acetate of lead or carbonate of lime, which precipitates the blue combination, and at the same time the sulphuric acid. A colourless liquid is separated by filtration, in which the presence of iron may be demonstrated in the state of protoxide.

"These experiments are insufficient to explain this curious reaction. It is not improbable to admit, as M.M. Berzelius and Chevreul have done *a priori*, that the oxygen combining with the gallic acid or the tannin converts them into a new acid of a blue colour; but positive experiments were wanting to decide the point.

"When a solution of tannin or of gallic acid is poured by drops into a solution of persulphate of iron in excess, no blue colouring is obtained; if there is one produced it is only momentary. Nor is there one formed with the same salt in minimum in presence of chlorine, nor with a protosalt of iron and

<sup>1</sup> Compt. rend., 127, 433 (1898).

<sup>2</sup> "A Manual of Dyeing," 222 (1875).

gallic acid oxidised in various degrees by chlorine, by a salt of silver, or lastly by the atmosphere in an alkaline solution.

"When a solution of gallic acid in excess is conveyed into persulphate of iron, and the liquid thrown down by acetate of lead, a blue paste is obtained, which treated with oxalic acid forms soluble oxalate of iron; the blue color disappears entirely, and is restored by acetate of soda. The solution of the oxalate, diluted very much with water, treated cautiously with the two prussiates and sulphuretted hydrogen, presents all the characters of the salts of iron in the state of peroxide and protoxide.

"It appears to me that we may conclude from the above facts, that if we start with a protosalt of iron, it is requisite to add oxygen, and if we set out with a persalt, some oxygen must be removed, in order to produce the blue compound, and that this compound contains the two oxides. In the first case the protoxide of iron combines with the oxygen of the atmosphere; in the second, a portion of the oxygen of the peroxide destroys a corresponding portion of the gallic acid or of the tannin, converting it into a brown substance. This substance does not enter into the constitution of the new compound, which must be considered as a salt formed of tannin or gallic acid and of an intermediate oxide of iron, probably of a blue color, the tint of which is slightly altered by this brown substance.

"To prove in the most evident manner that the blue colouring is not to be ascribed to a blue acid, but to a particular oxide, I endeavoured to obtain other blue salts with mineral acids—for instance, with sulphuric acid. For this purpose I prepared some mixtures in variable proportions of the protosulphate of iron and of the persulphate, and to avoid an inevitable separation of the two salts from their different degrees of solubility, I removed the water *immediately* by adding to the solution concentrated sulphuric acid in large excess, taking care to produce as little heat as possible. In this manner I obtained a thick paste of a *deep blue*, the tint of which was more or less pure according to the proportions of the two salts of iron. I likewise produced a blue sulphate, but of very ephemeral existence by evaporating rapidly a mixture of the two salts of iron; the blue tint appeared at the moment when the mass was nearly dry. On substituting phosphate of soda for the sulphuric acid, I obtained a deep-blue phosphate of iron and some sulphate of soda, which removed the water immediately. I endeavoured, but without success, to prepare combinations with other salts; the hyposulphite of soda alone afforded an intense blue coloring, but of remarkable instability. This is not surprising: there are many instances in chemistry of bases which prefer combining with certain acids and refuse to unite with others—such, for instance, among others, is the protoxide of copper.

"I have made experiments to obtain the blue oxide in a free state; I succeeded several times, but under circumstances which I was not able to produce at will. It is, however, a well-known fact, that when a protosalt of iron is precipitated with ammonia in contact with the atmosphere, the white precipitate of the protoxide soon becomes green, passing first, however, through blue.

"The impossibility of obtaining the blue sulphate or iron in a crystalline state, and of isolating the acid of the blue gallate compound, prevented me from having recourse to analysis in order to arrive at the formula for these intermediate salts: I was forced to proceed by synthesis, which I confess is far from being accurate, and it is with some doubts that I publish the results.

"Of all the mixtures of protosulphate and persulphate which I experimented on, that which afforded the most pure blue with sulphuric and gallic acids and with the phosphate of soda, contained precisely three equivalents of protosalt to two of the per salt—proportions which correspond to the cyanide  $\text{Fe}_7\text{O}_6$ , Prussian blue.

"If, as I hope, I have rendered probable the existence of two intermediate oxides of iron, capable of forming salts and of entering into the salts with their peculiar colour, I shall have thrown some light on the various tints produced by the different kinds of astringent substances, morphine, salicylic acid, and some other organic principles; and likewise on the production of violet, black, brown, and green tints, with red and yellow colouring principles, in presence of salts of peroxide of iron. I have convinced myself that all the yellow-colouring substances (for instance, curcuma) do not produce green; that the red colouring principles (among others aloetic acid) do not give a violet; and that when there is a production of green (as with Persian berries and the quercitron), or of violet (as with madder, logwood, etc.), the phenomena are identical with those which occur with tannin and gallic acid. These observations agree, moreover, perfectly with the suppositions of M. Thénard, with the facts published by M. Köchlin-Schonch, and by M. Schlumberger, and which M. Stackler informs me he has found confirmed in his establishment, that the iron mordants should be at a fixed degree of oxidation to produce beautiful dyes."

Where Napier says "an intermediate oxide of iron, probably of a blue colour," we say "a blue modification of ferric oxide." The ratio of  $\text{FeO}$  to  $\text{Fe}_2\text{O}_3$ , as found by Napier is 0.675 which agrees with McCarthy's figures.

The general conclusions of our experimental work are as follows:

1. The blue color of iron compounds is due to an instable, blue, modification of ferric oxide, which is stabilized chiefly by ferrous oxide but to some extent by other substances.
2. In alkali borate melts ferrous oxide is colorless, ferric oxide is yellow, and a certain mixture of ferrous oxide and ferric oxide is blue. The greens are due to a mixture of the blue and the yellow.
3. Using hydrogen as the reducing agent, the reduction of iron oxide to metallic iron takes place very readily when the alkali concentration in the melt is low.
4. A slightly higher concentration of alkali prevents the formation of metallic iron, but does not favor the complete reduction of ferric to ferrous oxide, on account of the low solubility of the former and of the hydrogen.
5. A high concentration of alkali checks the reduction to ferrous oxide.

6. When the ratio of ferrous oxide to ferric oxide reaches three in the borate glasses, most people call the glass free from green. When the same ratio reaches four or more, the blue becomes very beautiful.

7. It is easier to reduce ferric oxide in a potash-boric acid bead than in a soda-boric acid bead, which is the reason that the best blues are obtained in the potash-borate glasses.

8. If any substance in the borate glass reacts with ferric oxide to form colorless ferrite, the glass will become bluer if all other variables remain the same.

9. From what we know about red chromium oxide in alumina and in glass, the ratio of ferrous oxide to ferric oxide necessary for a good blue may be quite different in a silicate glass from what it is in a borate glass.

10. The general principles which have been established for borate glasses are applicable also to fired clays and to iron-bearing minerals.

*Cornell University*

# A COMPARISON OF THE CATALYTIC AND CHEMICAL CHARACTERISTICS OF CUBIC AND RHOMBOHEDRAL $\text{Fe}_2\text{O}_3$ \*

BY P. H. EMMETT AND KATHARINE S. LOVE

## Introduction

For many years it has been known that a magnetic form of ferric oxide exists. As pointed out by Herroun and Wilson<sup>1</sup> such an oxide was mentioned by Robbins in 1859<sup>2</sup> and later by both Malaguti<sup>3</sup> and Liversidge.<sup>4</sup> A review of the literature<sup>5</sup> in more recent years reveals many additional references to a magnetic  $\text{Fe}_2\text{O}_3$ . Welo and Baudisch<sup>6</sup> have shown that "magnetic  $\text{Fe}_2\text{O}_3$ " is not merely a thin layer of non-magnetic  $\text{Fe}_2\text{O}_3$  over magnetic  $\text{Fe}_3\text{O}_4$ . They have pointed out the additional interesting fact that the x-ray powder photographs of this magnetic  $\text{Fe}_2\text{O}_3$  are indistinguishable from those of  $\text{Fe}_3\text{O}_4$ . Hendricks and Albrecht<sup>7</sup> working with  $\text{Co}_2\text{O}_3 \cdot 2\text{Fe}_2\text{O}_3$  and  $\text{CoOFe}_2\text{O}_3$ , compounds that are analogous to the above-mentioned cubic  $\text{Fe}_2\text{O}_3$  and  $\text{Fe}_3\text{O}_4$ , concluded that in this case also, within the error of experimental observation, no difference exists between the powder photographs obtained from the two forms. The following conclusions can be drawn from the previous work: (1) within the limits of error of present observations the x-ray powder photographs obtained from cubic and from rhombohedral  $\text{Fe}_2\text{O}_3$  are identical; (2) the magnetic permeability of the cubic  $\text{Fe}_2\text{O}_3$  is similar to that of  $\text{Fe}_3\text{O}_4$ ; (3) the cubic modification of the oxide can be changed into the more stable rhombohedral modification by heating to various temperatures between 550° and 1000°C. The transition temperature depends upon the method of preparation of and the impurities contained in the sample.

Welo and Baudisch<sup>6</sup> studied the comparative chemical and catalytic characteristics of the two oxides. They prepared samples of cubic  $\text{Fe}_2\text{O}_3$  by heating hydrated<sup>8</sup>  $\text{Fe}_2\text{O}_3$  for several hours in a stream of air at a tempera-

\*Fertilizer and Fixed Nitrogen Investigations, Bureau of Chemistry and Soils, Washington, D. C.

<sup>1</sup> Herroun and Wilson: Proc. Phys. Soc. London, 41, (pt. II) 100 (1928).

<sup>2</sup> Robbins: Chem. News, 1, 11 (1859).

<sup>3</sup> Malaguti: Ann. Chim. Phys. (3), 69, 214.

<sup>4</sup> Liversidge: Trans. Aust. Assoc. Hobart Meeting (1892).

<sup>5</sup> Hauser: Ber., 40, 1958-60 (1907); Sosman and Hostetter: Bull. Am. Inst. Mining Eng. 1917, 907-31; Abraham and Planiol: Compt. rend., 180, 1328-9 (1925); Chevallier: 180, 1473-5 (1925); 184, 674-6 (1927); Sosman and Posnjak: J. Wash. Acad. Sci., 15, 329-42 (1925); Wedekind and Albrecht: Ber., 59, 1726-30 (1926); 60, 2239-43 (1927); Huggett and Chaudron: Compt. rend., 186, 1617-9 (1928).

<sup>6</sup> Welo and Baudisch: Phil. Mag., 50, 399-408 (1925).

<sup>7</sup> Hendricks and Albrecht: Ber., 61, B, 2153-61 (1928).

<sup>8</sup> Welo and Baudisch: J. Biol. Chem., 65, 215-27 (1925).

<sup>9</sup> In the present paper the term "hydrated  $\text{Fe}_2\text{O}_3$ " should be used to describe the precipitate formed by adding an iron nitrate solution containing a 2:1 mol ratio of  $\text{Fe}^{+++}/\text{Fe}^{++}$  to hot  $\text{NaOH}$ , or strong  $\text{NH}_4\text{OH}$ .

ture of 300°C or less. The hydrated  $\text{Fe}_2\text{O}_3$  was initially prepared by adding the appropriate mixture of ferrous and ferric iron solutions to hot NaOH, and filtering, washing and drying the precipitate. The rhombohedral  $\text{Fe}_2\text{O}_3$  was prepared by heating the cubic form in air to a temperature of 550°C or more. The relative catalytic and surface characteristics of the two oxides prepared in the above manner were then determined by (1) the catalytic oxidation of benzidine with hydrogen peroxide; (2) the growth of *Bacterium leprosepticum*, (3) the absorption of oxygen; and (4) the absorption of water vapor at 25°C from air saturated at the same temperature. The first three of the above comparisons revealed such a marked difference in activity between the cubic sample and the rhombohedral sample as to cause Welo and Baudisch to designate them as "active" and "inactive"  $\text{Fe}_2\text{O}_3$ . The fact that the water sorption values were approximately the same for both oxides, being in each case some 20 to 27% of the weight of the samples used, was interpreted as sufficient evidence that the total overall surface of the two oxide samples was the same and that the differences noted above were to be attributed to a difference in crystal structure. Accordingly, they concluded that the catalytic activity of  $\text{Fe}_2\text{O}_3$  depends on its crystal structure and may be vanishingly small for the rhombohedral modification.

A priori, one might expect just such results as obtained by these authors. It has been pointed out<sup>1</sup> that in order to convert  $\text{Fe}_3\text{O}_4$  to an isomorphous  $\text{Fe}_2\text{O}_3$  form it is necessary to crowd 4 atoms of oxygen into each unit of structure of the  $\text{Fe}_3\text{O}_4$ . Furthermore, attention has been called<sup>1,2</sup> to the fact that either of two possible positions assigned by symmetry considerations to these atoms apparently necessitates their being crowded into positions not sufficiently large to admit oxygen atoms of normal diameters without distorting the lattice. These extra oxygen atoms might be expected to be removed from the cubic  $\text{Fe}_2\text{O}_3$  lattice by reduction more easily than the normal oxygen atoms from the stable  $\text{Fe}_2\text{O}_3$ . By the same line of reasoning a marked difference in catalytic activity even to the point of one being "active" and the other "inactive" might not be surprising.

However, closer examination of the procedure employed by Welo and Baudisch led the authors to the conclusion that the evidence for cubic  $\text{Fe}_2\text{O}_3$  being "active" and rhombohedral  $\text{Fe}_2\text{O}_3$  being "inactive" is not conclusive. Their catalytic and surface work is open to objection due to the presence of the following disturbing factors: (1) The fact that the cubic sample of  $\text{Fe}_2\text{O}_3$  as tested, had been heated to only 300°C. whereas the rhombohedral sample had been heated to 550°C. or higher, renders the drawing of valid conclusions as to the dependence of catalytic activity upon the crystal structure of the two materials impossible. (2) The catalytic tests used are at best qualitative and are not sufficiently diversified to warrant drawing general conclusions relative to catalytic activity. (3) The presence of impurities such as NaOH or  $\text{Na}_2\text{SO}_4$  might materially affect the tests made. (4) The values obtained

<sup>1</sup> Hendricks and Albrecht: Ber., 61B, 2153-61 (1928).

<sup>2</sup> Welo and Baudisch: Phil. Mag., 50, 399-408 (1925).

TABLE I  
Preparation of Oxides

Designation of oxides	Crystallographic form	Precipitating Agent	Salt Solution from which precipitation was made	Drying in air Temp. °C	Hours	Appearance of final oxide
1	Rhombohedral	Approximately 20% NH <sub>4</sub> OH	Fe(NO <sub>3</sub> ) <sub>3</sub>	300	51	Dark brown, shiny
2	Cubic	"	Fe(NO <sub>3</sub> ) <sub>3</sub> and Fe(NO <sub>3</sub> ) <sub>2</sub>	300	51	Red brown
3	Rhombohedral	"	Fe(NO <sub>3</sub> ) <sub>3</sub> and Al(NO <sub>3</sub> ) <sub>3</sub>	300	51	Very dark brown, shiny
4	Cubic	"	Fe(NO <sub>3</sub> ) <sub>3</sub> , Fe(NO <sub>3</sub> ) <sub>2</sub> and Al(NO <sub>3</sub> ) <sub>3</sub>	300	51	Chocolate brown
5	Rhombohedral	Hot 7% NaOH	Fe <sub>2</sub> (SO <sub>4</sub> ) <sub>3</sub>	300	51	Dark red
6	Cubic	"	Fe <sub>2</sub> (SO <sub>4</sub> ) <sub>3</sub> and FeSO <sub>4</sub>	300	51	Dark brown, shiny
2a	Rhombohedral	Made by heating No. 2 in air at 550° for 2 hours				Bright red
5a	Rhombohedral	Made by heating No. 5 in air at 550° for 2 hours				Dark red
6a	Cubic	Made by heating No. 6 in air at 550° for 2 hours				Dark brown, shiny

for water sorption are neither of the right order of magnitude nor taken in such a manner as to disclose the relative surface areas of the oxides. The picking up of 25% by weight of water vapor by the oxides was to a considerable extent doubtlessly hydrate formation, capillary condensation, or absorption of H<sub>2</sub>O by hygroscopic impurities in the test samples. This latter source of error was especially apparent in one sample that was reported to have picked up water equivalent to 95% of its own weight. Part of the water was admittedly "free and flowed about in the boat in which the dry oxide had been placed."

The present research has, therefore, been carried out and consists in a study of: (1) the catalytic activity of the two forms of iron oxide prepared under identical conditions; (2) the sorption of water vapor upon each; (3) the effect of Al<sub>2</sub>O<sub>3</sub> upon the rate of change of the magnetic permeability of the cubic Fe<sub>2</sub>O<sub>3</sub>, at temperatures ranging from 450 to 600°C; (4) The rate of reduction by hydrogen of the cubic and rhombohedral samples; (5) the influence of Al<sub>2</sub>O<sub>3</sub> upon the rate of reduction of cubic Fe<sub>2</sub>O<sub>3</sub> to Fe<sub>3</sub>O<sub>4</sub> and to Fe.

#### Preparation of Oxide Samples

To avoid several of the above-mentioned disturbing factors in the work of Welo and Baudisch, it was necessary to prepare samples both of cubic and of rhombohedral Fe<sub>2</sub>O<sub>3</sub> by methods of precipitation, filtration and drying that were as nearly analogous as possible. This was accomplished as described below by precipitating Fe(OH)<sub>3</sub>, drying the precipitate at 300°C in air, to form the rhombohedral Fe<sub>2</sub>O<sub>3</sub>, and comparing it with a sample of cubic Fe<sub>2</sub>O<sub>3</sub> obtained from similar oxidation of hydrated Fe<sub>2</sub>O<sub>4</sub> in air at 300°C. To preclude the possibility of traces of NaOH or Na<sub>2</sub>SO<sub>4</sub> disturbing the tests, samples were prepared using NH<sub>4</sub>OH as precipitating agent instead of NaOH. In addition, of course, samples were used that were prepared and treated in the same manner as those of Welo and Baudisch.

TABLE II  
Analysis of the Oxides

Catalyst Number	Crystal Form*	Per cent Al <sub>2</sub> O <sub>3</sub>	Per cent NaOH	Per cent Ferrous Fe	Per cent Fe(NO <sub>3</sub> ) <sub>3</sub>	Per cent Total Fe as Fe <sub>2</sub> O <sub>3</sub> in Sample	
						As taken from bottle	After ignition to 800-1000° for 2 hrs. in elec. furnace
1	Rhombohedral	—	—	—	None	99.36	100.9 (1)
2	Cubic	—	—	None	—	99.63	100.7 (1)
3	Rhombohedral	1.58	—	—	—	—	—
4	Cubic	1.55	—	None	None	—	—
5	Rhombohedral	—	1.12	—	None	—	—
6	Cubic	—	0.12	0.07	None	—	—

<sup>1</sup> Possibly the formation of some ferrous iron by ignition of the oxide is the cause of this apparent high analytical result.

\* The crystalline forms of the samples were determined by X-ray photographs very kindly taken by Dr. S. B. Hendricks of this Laboratory.



Nine samples of catalysts were prepared as indicated in Table I. In all cases the precipitate was washed by decantation until the decanted liquid was not alkaline. Two or three additional washings were then made. All samples were dried in air that had passed through soda lime and finally  $P_2O_5$  tubes. The temperature of the drying furnace was automatically held at  $300^\circ \pm 10^\circ C$ . The samples were sealed in glass-stoppered bottles till ready for use.

Samples of the various catalysts were analyzed for possible impurities. Samples 1 and 2 were analyzed for total iron, the original weight being that of the sample as taken directly from the sample bottle. They were then heated for 2 hours at  $800^\circ-1000^\circ C$ ., cooled in a desiccator, and again analyzed for total  $Fe_2O_3$ . The results are shown in Table II.

#### Catalytic Oxidation of Benzidine and Guajac Resin by Hydrogen Peroxide

As a measure of catalytic activity, 4 reactions were made use of: the oxidation of benzidine by hydrogen peroxide in the presence of the catalyst, the oxidation of guajac resin by hydrogen peroxide in the presence of the catalyst, the catalytic combination of hydrogen and oxygen at a temperature of  $250^\circ C$ ., and the catalytic decomposition of ozone at temperatures ranging from  $-75^\circ C$  to  $25^\circ C$ .

TABLE III  
Activities of the Catalysts toward Organic Oxidation Reactions

	Good (a)	Fair	Very Poor
Benzidine oxidation	5,1,3,2,6,4,	6a	5a, 2a
Guajac resin oxidation	5,6,1,3,4,2	6a	5a, 2a

(a) The "good" catalysts are arranged in order of their decreasing activity. However, the activities of catalysts 1-6 toward both benzidine and guajac resin were so nearly the same that it was difficult to distinguish between them. Accordingly, for these oxidation reactions one is justified in concluding merely that the rhombohedral modification of  $Fe_2O_3$  is at least as active catalytically as is the cubic form.

The results obtained by repeating the tests mentioned by Welo and Baudisch were, due to the nature of the tests, necessarily qualitative. They show clearly, however, as can be seen in Table III, that the activity of the rhombohedral catalysts dried in air at  $300^\circ C$ ., (catalysts 1, 3 and 5) is as great as, or greater than that of the corresponding cubic  $Fe_2O_3$  prepared in air at  $300^\circ$  (catalysts 2, 4 and 6). Furthermore, heating either cubic  $Fe_2O_3$  or rhombohedral  $Fe_2O_3$  to  $550^\circ$  destroys its activity (catalysts 2a and 5a, respectively).<sup>1</sup>

<sup>1</sup> Unfortunately sample 6a as treated throughout this paper was prepared and used before noting that the several hours treatment at  $550^\circ$  had but slightly impaired its magnetic permeability. Either traces of impurities or some characteristics of the method of precipitation render this oxide less readily convertible to the rhombohedral form and make difficult and slow also the change of catalytic and, as we shall later see, other properties. However, the behavior of catalysts 1, 2, 3, 4, 5, 2a and 5a pointed out above leaves no doubt as to the catalytic activity in these reactions being dependent upon heat treatment of the oxide and not upon their crystal structure.

It is believed, therefore, that the difference in activity of cubic and rhombohedral  $\text{Fe}_2\text{O}_3$  previously ascribed to crystal structure can in reality be explained by differences in the thermal treatment of the two oxides. Accordingly, in so far as these two reactions are indicative of catalytic activity, the conclusion seems warranted that both cubic and rhombohedral  $\text{Fe}_2\text{O}_3$  have approximately the same activity.

A search of the literature revealed very little information relative to the exact nature of the two catalytic reactions here cited. Hence several observations made during the present work may be of interest. It was definitely ascertained that a very small amount of ferric iron was sufficient to give the blue coloration produced in either of these reactions. In fact, the resin test for ferric iron is of the same order of sensitivity as the well-known KSCN test.

To ascertain whether traces of ferric iron from some  $\text{Fe}(\text{NO}_3)_3$  occluded as an impurity in the oxide might not be responsible for the so-called catalytic activity manifested by samples 1 to 6 mentioned in the above table, thorough digestions of the oxides in water were carried out, both with and without hydrogen peroxide. Subsequent test of the filtrate from this oxide water mixture failed to give a measurable trace of ferric iron with KSCN. Similarly, tests of the filtrate with the resin and hydrogen peroxide resulted in no blue coloration. However, the addition of a small amount of catalyst to this mixture of filtrate,  $\text{H}_2\text{O}_2$  and resin extract, immediately produced a deep blue coloration. Thus, it seems that the two organic oxidations are catalyzed or caused to occur either by the iron oxide itself or by some impurity not removed from the oxide by repeated washing but dispelled by heating to  $55^\circ\text{C}$ .

#### Catalytic Combination of Hydrogen and Oxygen

Determination of the efficiency of the catalysts toward the hydrogen-oxygen reaction was made by passing a mixture of 97.5% oxygen and 2.5% hydrogen at a rate of flow of 116 cc. per min. over 4 cc. of catalyst. The apparatus used is essentially that originally described by Pease and Taylor.<sup>1</sup> The oxygen was purified by passage over hot platinized asbestos, through concentrated  $\text{H}_2\text{SO}_4$ , soda lime, and finally  $\text{P}_2\text{O}_5$ . The hydrogen was generated electrolytically from a NaOH solution using platinum electrodes. The hydrogen-oxygen mixture from the cell joined the stream of oxygen gas before entering the sulfuric acid wash tube. The only rubber connection in the line was a short one between the tank of oxygen and the entrance to the purification line. The apparatus throughout was of Pyrex. The water vapor formed by the catalytic combination of the hydrogen and oxygen was determined by dehydrite-filled weighing tubes. The exit gas from the weighing tubes was analyzed for hydrogen. Great care was taken during each run to embed the thermometer the same distance in the bed of catalyst. The catalyst samples were broken to about 20 mesh size and runs at  $250^\circ$  were carried out. Runs at  $315^\circ\text{C}$  were also made, but the conversions were so

<sup>1</sup> Pease and Taylor: J. Am. Chem. Soc., 43, 2181 (1921).

high as to be of little use in differentiating between the activities of the catalysts. The results obtained in this series of catalytic runs are summarized in the tables below:

TABLE IV  
H<sub>2</sub>-O<sub>2</sub> Catalysis

Catalyst number	Crystal Form	Weight of Sample (grams)	Apparent Volume of Sample (cc)	A		B		Efficiency = $\frac{A}{A+B}$
				H <sub>2</sub> O formed (mg./5 min.)	Exit H <sub>2</sub> in terms of equivalent H <sub>2</sub> O/5 min.	250°C	250°C	
1	rhomb.	5.16	4	5.3	3.6	0.60		
2	cubic	3.26	4	4.3	5.4	0.44		
2a	rhomb.	3.43	4	4.4	5.1	0.46		
3	rhomb.	5.24	4	5.1	3.9	0.56		
4	cubic	4.17	4	3.7	6.1	0.38		
5	rhomb.	5.27	4	3.0	—	0.30		
5a	rhomb.	5.54	4	1.5	8.2	0.16		
6	cubic	4.51	4	2.8	6.3	0.31		
6a	cubic	4.33	4	1.6	8.2	0.17		

A = mg. H<sub>2</sub>O formed per 5 min. at steady state by passage of the hydrogen-oxygen mixture over the Fe<sub>2</sub>O<sub>3</sub>.

B = mg. H<sub>2</sub>O equivalent to the hydrogen not catalyzed to water by passage over Fe<sub>2</sub>O<sub>3</sub>.

It will be noted that the activity of the rhombohedral Fe<sub>2</sub>O<sub>3</sub> is as high or higher in every case than that of the corresponding cubic Fe<sub>2</sub>O<sub>3</sub> as evidenced by the higher conversions obtained on passing the gaseous mixture over equal volumes of the two catalysts. However, as will be noted in Table IV, the heating of sample 2 to 550°C seemed to have no effect upon its ability to catalyze the combination of the hydrogen-oxygen mixture. It is thus apparent that for some reason this reaction will not distinguish between the catalytic activities of oxides that in the organic oxidations manifest manifold differences. The probable significance of the results here obtained in the hydrogen-oxygen reactions will be discussed again in connection with the water sorption values.

#### Ozone Decomposition

For comparing the catalytic activity of cubic Fe<sub>2</sub>O<sub>3</sub> with that of rhombohedral Fe<sub>2</sub>O<sub>3</sub> for the decomposition of ozone, catalysts 1, 2 and 2a were chosen. The experiments were made in a flow system over a temperature range of -74° to 25°C.

The oxygen, purified as described above, was passed at 100 cc. per min. through an ozonizer of the type used and described by Karrer and Wulf.<sup>1</sup> With 85 volts on the primary of a 1 kw., 110-25,000 V. transformer, an ozone volume concentration of approximately 2% could be produced in the flowing oxygen.

<sup>1</sup> Karrer and Wulf: J. Am. Chem. Soc., 44, 2392 (1922).

The experiments were carried out in an apparatus of the type shown in Fig. 1. The catalyst tubes were joined to the main ozone supply by paraffined joints in the way suggested by Ray and Anderegg.<sup>1</sup> Thoroughly washed and dried asbestos wads were found not to catalyze the decomposition at room temperature and were therefore used to support the catalyst sample. Very small samples of catalyst had to be used in order to avoid complete decomposition of the ozone even in the runs at  $-74^{\circ}\text{C}$ . The exit ozone from the catalyst tube was determined in the usual way by passing it through

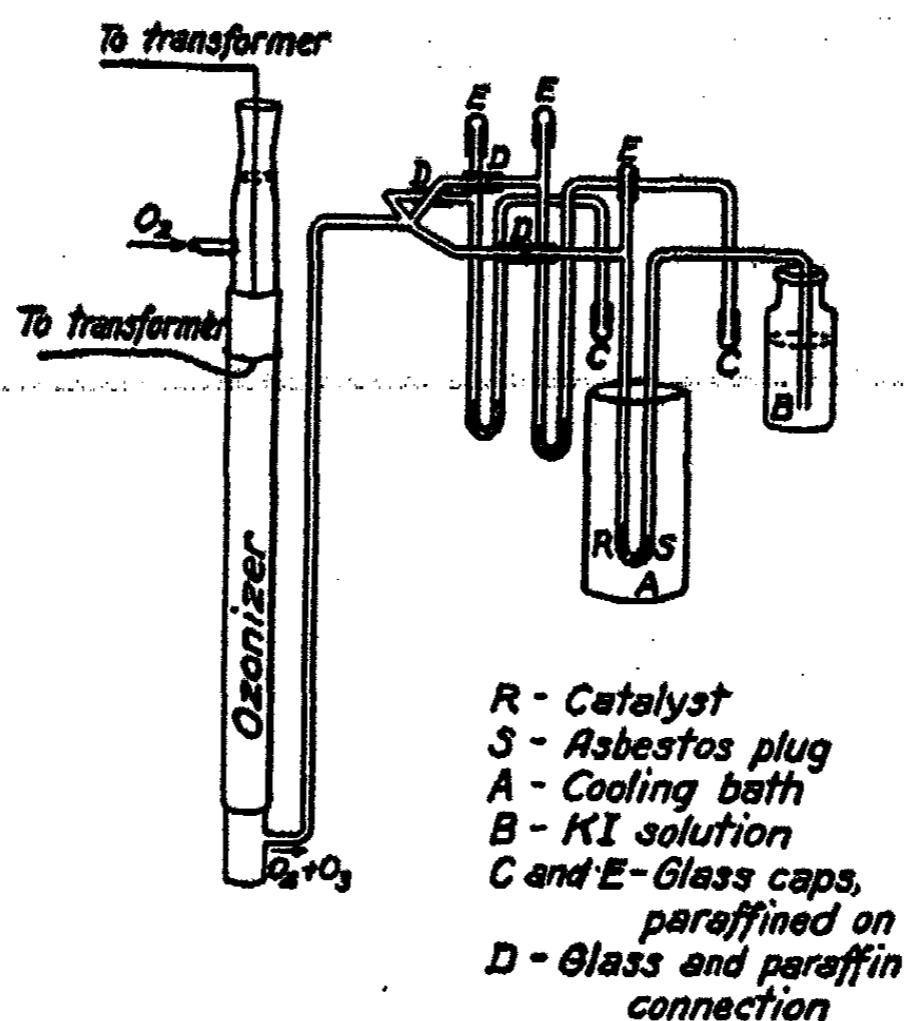

FIG. 1

potassium iodide solution, acidifying the resulting solution with  $\text{H}_2\text{SO}_4$ , and titrating the liberated iodine with sodium thiosulfate. The titration with .1 N sodium thiosulfate solution was sensitive to  $\pm 0.03$  cc. of ozone. Five minute runs with a flow of 100 cc. of oxygen per minute were used throughout. The low temperatures were obtained by the hand regulation of a  $\text{CO}_2$  alcohol bath and were constant within a degree or so during any set of runs.

The results of these catalytic runs are summarized in the Table V.

The results show that catalysts 1 and 2, the rhombohedral and cubic samples of  $\text{Fe}_2\text{O}_3$ , manifest practically no difference in catalytic activity as regards the decomposition of ozone under the conditions mentioned above. The values for catalyst 2a at  $-74^{\circ}\text{C}$ , recorded in Table VI, indicate a rate of ozone decomposition about 65% smaller than for catalyst 2. Similar samples of 2a used in later runs were from 30 to 75% less active than catalyst 2. While the results seem to indicate the superiority of catalysts 1 and 2 over catalyst

<sup>1</sup> Ray and Anderegg: J. Am. Chem. Soc., 43, 969 (1921).

**TABLE V**  
**Catalytic Decomposition of Ozone**  
 The relative activities of  
 .047 gram (.037 cc., calculated) of Catalyst No. 1  
 .031 gram (.038 cc., calculated) of Catalyst No. 2  
 .030 gram (.035 cc., calculated) of Catalyst No. 2a  
 Gas flow to ozonizer = 100 cc. O<sub>2</sub> per minute  
 Gas leaving ozonizer contained approximately 2% O<sub>3</sub>.

Catalyst number	Temperature °C	No. of consecutive 5 minute runs	Range of per cent Decomposition	Per cent Decomposition at Steady State
1	24	6	100-99.9	99.9
1	-30	5	99.2-99.0	99.0
1	-73	5	92.7-94.2	94.2
2a	27	12	91.1-85.4	85.8
2	26	5	99.3-99.8	99.8
2	-30	5	98.6-98.2	98.4
2a	-30	5	76.3-73.3	73.3
2a	23	9	91.5-87.8	88.5
2a	-74	8	55.2-51.7	52.1
2	-73	6	92.3-90.7	90.7
1	-74	3	89.8-89.0	89.0
2	20	6	99.2-98.5	98.7

**Summary of the Steady State Values**

	23-25°C	-30°C	-74°C
1	99.9	99.0	94.2 89.0
2	99.8 98.7	98.4	90.7
2a	85.8 88.5	73.3	52.1

2a, they do not indicate a difference of even the same order of magnitude as the one shown to exist in the case of guajac resin or benzidine oxidation with hydrogen peroxide.

As a means of obtaining an approximate estimate of the small temperature coefficient indicated by the above experiments, a few determinations of the variation of the rate of catalytic ozone decomposition with variations in the temperatures and the ozone concentrations were made. The percent ozone in the entering oxygen stream was varied by changing the voltage on the primary of the transformer. The results, obtained upon varying the ozone content of the entering gas, are shown by the data in Table VI. Values for the apparent reaction velocity constants, obtained both on the assumption

TABLE VI  
 Order of Reaction—Catalytic Decomposition of Ozone  
 .032 gram (.037 cc., calculated) of catalyst No. 2a  
 Gas flow to ozonizer = 100 cc. O<sub>2</sub> per minute  
 Temperature = -74°C.

Per cent O <sub>2</sub> initial gas stream	Per cent O <sub>2</sub> in exit gas	First Order decomposition $k_1 = \frac{1}{t_0} \ln \frac{p_0}{p}$	Second Order decomposition $k_2 = \frac{1}{t_0} \left( \frac{1}{p_f} - \frac{1}{p_0} \right)$
1.99	0.577	40.7	5.32
1.99	0.582	40.4	5.25
1.99	0.625	38.0	4.74
1.99	0.610	38.8	4.91
1.99	0.622	38.2	4.77
0.919	0.318	34.8	8.88
0.919	0.325	34.1	8.59
0.919	0.334	33.2	8.23
0.919	0.340	32.6	8.01
0.919	0.356	31.1	7.44
1.99	0.726	33.1	3.78
1.99	0.746	32.2	3.52
1.99	0.759	31.7	3.52
1.99	0.762	31.5	3.50
0.919	0.403	27.1	6.02
0.919	0.410	26.5	5.84
0.919	0.414	26.2	5.73

that the catalytic decomposition is first order with respect to the partial pressure of ozone, and on the assumption that it is second order, are included in this table. The calculations were made by the method ordinarily used for catalytic flow systems.

Thus

$$(1) \quad k_1 = 1/t_0 \ln p_0/p_f = \frac{V T P}{60 V_0 273} \ln \frac{p_0}{p_f}$$

where

V = total gas flow in cc. (S.T.P.) per min.

V<sub>0</sub> = Apparent volume of the catalyst as measured approximately in a small calibrated glass tube.

T = Absolute temperature of catalyst chamber.

P = Total pressure in catalyst tube = 1 atmosphere in present experiments.

p<sub>f</sub> = Partial pressure of ozone in exit gas

p<sub>0</sub> = Partial pressure of ozone in entering gas

k<sub>1</sub> = Apparent reaction velocity constant for the catalyst (time in seconds).

Similarly, for the second order calculations,

$$(2) \quad k_2 = 1/t_0 (1/p_f - 1/p_0)$$

where  $p_f$  and  $p_0$  are expressed in mm.

$$= \frac{V T P}{60 V_0 273} \left( \frac{1}{p_f} - \frac{1}{p_0} \right)$$

In both equations,  $t_0$  = "time of contact," and hence may be expressed in terms of the gas flow and volume of catalyst as shown in the equations. The above equations are identical with those that one obtains from calculations of the Langmuir type,<sup>1</sup> assuming the reacting gas to be slightly adsorbed and the decompositions to be monomolecular and bimolecular, respectively, on the surface of the oxide.

In Fig. 2 are shown the  $k_1$  and  $k_2$  values obtained from the data of Table VI. The gradual drift in the successive readings presumably is due to a slight poisoning of the catalyst at  $-74^\circ\text{C}$ . It does not, however, invalidate the conclusion that the decomposition follows approximately a first order equation. The agreement with the second order equation is poor. Furthermore, a moment's reflection upon the data will show that it does not correspond to a zero order reaction. Hence, these preliminary runs indicate that the decomposition of ozone over  $\text{Fe}_2\text{O}_3$  is an apparent first order reaction.

Data for additional experiments at three different temperatures are shown for catalyst 2a in Table VII. The values of  $k_1$  for these two runs are plotted against  $1/T$  values in Fig. 3. From the slopes of these two curves and from data for several other runs an "apparent energy of activation" of  $2000 \pm 500$  calories per mol of  $\text{O}_3$  is indicated.

<sup>1</sup> The reaction velocity constants  $k_1$  and  $k_2$  are of course to be distinguished from specific reaction velocity constants as ordinarily defined for homogeneous reactions. For a catalytic apparent monomolecular decomposition uninhibited by the products of reaction one can write for the reaction at constant volume

$$\frac{dp_A}{dt} = \chi \sigma S$$

where

- $p_A$  = partial pressure of reactant at any time
- $t$  = time in seconds
- $\chi$  = reaction rate per sq. cm. of adsorbed reactant on the surface
- $S$  = Total surface of the catalyst
- $\sigma$  = fraction of the surface covered by reactant.

The Langmuir adsorption isotherm equation,

$$\frac{dp_A}{dt} = \frac{kp_A}{1 + kp_A}$$

reduces to the simple form

$$\frac{dp_A}{dt} = kp_A$$

when the adsorption of gas A is slight. Hence

$$\frac{-dp_A}{dt} = \chi k S p_A = k_1 p_A$$

Similar considerations are involved in determining  $k_2$ . This equation when integrated becomes (1) above. Furthermore, application of the above equation to a flow system involves "time of contact" in a manner that is in error by several hundred percent. Thus in place of  $V_0$  in the above equations one should more correctly use  $V'_0$ , where  $V'_0$  equals  $V_0 - V_s$ , and  $V_s$  is the actual space occupied by the catalyst particles themselves.  $V'_0$  is usually between 25 and 75% as large as  $V_0$ . None of these factors, however, affects the validity of the conclusions drawn above as to the apparent order of reaction and "apparent temperature coefficient" of the catalytic reaction.

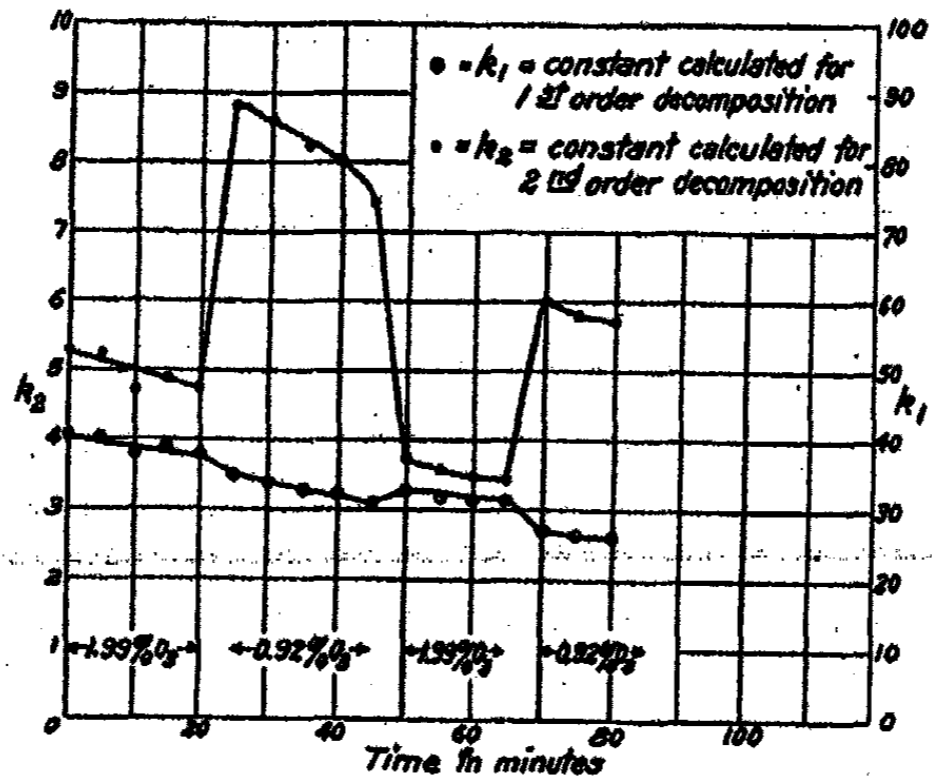

FIG. 2

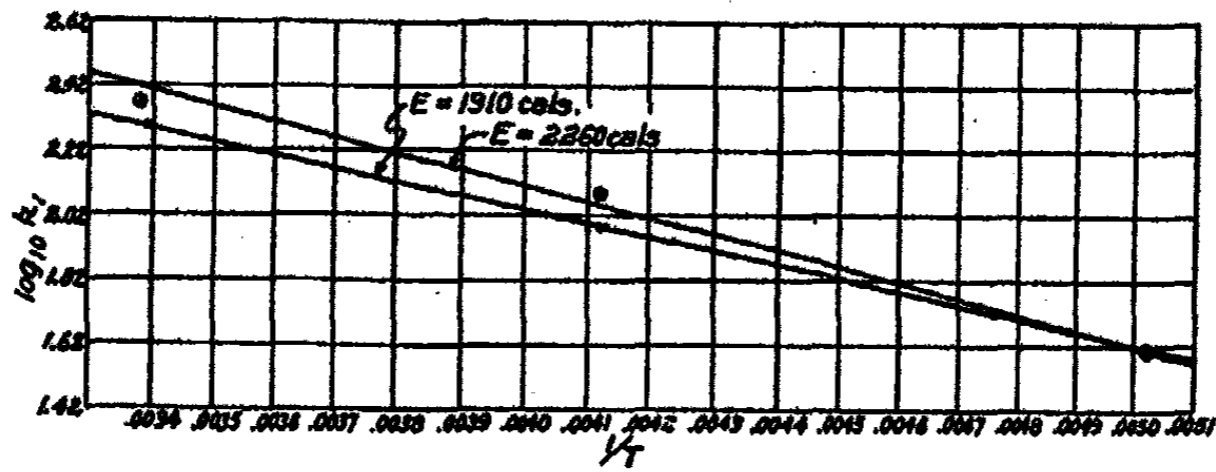

FIG. 3

Plot of  $1/T$  vs. the logarithm of the apparent reaction velocity constant for catalytic decomposition of ozone by  $\text{Fe}_2\text{O}_3$ .



TABLE VII

Temperature Coefficient of Catalytic Decomposition of Ozone  
 .032 gram (.037 cc., calculated) of Catalyst No. 2a  
 Gas flow to ozonizer = 100 cc. O<sub>2</sub> per minute  
 Gas leaving ozonizer contained 2% O<sub>2</sub>

Run 1		Run 2	
Temperature °C	Per cent Decomposition (a)	Temperature °C	Per cent Decomposition
23	99.2	22	98.0
24	99.2	22	98.2
23	99.4	22	98.6
23	99.2	22	98.2
23	99.0	22	98.1
-30	96.8	-31	93.1
-30	96.0	-31	92.8
-30	95.4	-31	92.2
-30	95.5	-30	92.7
-30	95.3	-30	91.2
		-31	91.3
		-30	91.4
		-30	91.6
-72	72.3	-74	70.7
—	72.6	-74	71.2
—	72.4	-74	71.8
—	71.7	-74	71.8
-74	71.0	-74	71.8
		-74	70.9

(a) Readings in Run No. 1 and Run No. 2 were taken chronologically in the order listed and for a 5 minute period. Between runs No. 1 and No. 2 the catalyst was closed over night in dry air.

It is hoped in the near future to study more closely the kinetics of the catalytic decomposition of ozone with larger amounts of less active catalyst and at room temperature, rather than  $-74^{\circ}\text{C}$ .

#### H<sub>2</sub>O Sorption by the Various Catalyst Samples

The water sorption values were determined both at  $25^{\circ}\text{C}$  and at  $210^{\circ}\text{C}$ . The values were obtained by passing a stream of nitrogen saturated with water vapor at  $0^{\circ}\text{C}$ ., and containing accordingly 0.57% water vapor, over the catalysts dried at  $257^{\circ}\text{C}$ . in situ immediately before each run. The water vapor in the exit stream of nitrogen was determined. Passage of the gas was continued until the exit and the entering water vapor contents were the same. The difference between the water content of the influent and effluent nitrogen stream during this saturating period was taken as the

TABLE VIII

Catalyst number	Temperature °C	Weight of sample grams	Apparent volume of sample calculated cc.	Water Sorption		Average	Mg. H <sub>2</sub> O sorbed per gram catalyst	Mg. H <sub>2</sub> O sorbed per cc. catalyst
				Mg. H <sub>2</sub> O Calculated from H <sub>2</sub> O going on catalyst	Mg. H <sub>2</sub> O sorbed Calculated from H <sub>2</sub> O coming off catalyst			
1	25	3.81	3.0	156.1	156.9	156.5	41.0	52.2
	210	3.81	3.0	26.2	24.3	25.3	6.6	8.4
2	25	4.24	5.2	98.9	100	95.5	23.5	19.1
	210	4.24	5.2	23.4	26.1	24.8	5.9	4.8
	210	3.17	3.9	13.1	13.4	13.3	4.2	3.4
3	25	4.74	3.6	248.5	251.6	250.1	52.8	69.5
	210	4.74	3.6	37.3	40.3	38.8	8.2	10.8
5	25	3.86	2.9	164	160	162	42.0	55.9
	210	3.86	2.9	24.8	24.1	24.5	6.3	8.4
6	25	3.85	3.4	64.8	70.1	67.5	17.5	19.8
	210	3.85	3.4	9.1	8.1	8.6	2.2	2.5
2a	25	3.58	4	26.7	22.8	24.8	6.9	6.2
	210	3.58	4	4.9	5.5	5.2	1.5	1.3
	210	3.62	4	4.7	6.1	5.4	1.5	1.4
	210 (a)	3.62	4	4.7	5.4	5.1	1.4	1.3
5a	25	4.87	3.5	71.0	71.9	71.5	14.7	20.4
	210	4.87	3.5	7.9	5.8	6.9	1.4	1.97
6a	25	2.85	2.6	30.8	42.2	36.5	12.8	14.0
	210	2.85	2.6	5.3	6.2	5.8	2.0	2.2
	210 (a)	2.85	2.6	3.5	5.5	4.5	1.6	1.7

(a) Run after H<sub>2</sub>-O<sub>2</sub> run.

"sorbed" water. This value was in every case checked by removing the water at 257°C. until the exit water was less than 1 mg. per hour. The values showed very good agreement with the check in every case. The results obtained for the different catalyst samples are shown below in Table VIII.

From the water sorption values the following conclusions are apparently justified:

- (1) The water sorption values per gram of catalyst for cubic  $\text{Fe}_2\text{O}_3$  samples are 10 to 60% smaller than those for the rhombohedral form.
- (2) The sorption on samples 2a and 5a is about 1/4 as great as that on the samples not heated at 550°C. Sample 6 withstands heating so well that it is not materially changed by a two hour exposure to a temperature of 550°C. Hence its water sorption value has changed but little.
- (3) Previous use of sample 2a or 5a for catalysis of a hydrogen-oxygen mixture does not increase the water sorption values.

It should be noted that whereas the activity of catalyst 2a as gauged by the hydrogen-oxygen catalysis is as high as that of catalyst 2, the water sorption value is only about 1/4 as large. This indicates the possibility of a sintering process being able to close up pores and crevices that play an important part in the "sorption" of water vapor, but not in the catalysis of a hydrogen-oxygen mixture.

#### Magnetic Permeability Determinations

The rate of change with heating of magnetic permeability of samples 2, 4, and 6 was determined by a method identical with that outlined by Welo and Baudisch. The experiments were made by alternately measuring the permeability of a particular oxide and heat treating it for an hour at some definite temperature. Such hourly heating periods were continued until the magnetic permeability became 1.05 or less.

The initial permeabilities of catalyst 2, 4 and 6 were 1.93, 2.28 and 2.48, as measured in a magnetic field intensity of 200 Gauss. These permeability measurements agree qualitatively with those of Welo and Baudisch. The results of the measurements are summarized in Fig. 4.

From the curves it is evident that catalyst 4 is definitely much slower in changing from the cubic to rhombohedral form, or, more correctly, in changing from a permeability of 2.3 to 1.05, than is catalyst 2. Both of these materials were prepared by identical methods, except for the addition of the promotor to No. 4; it would seem, therefore, reasonable to ascribe the inhibition of the rate of transformation to the promotor content. The rate of change of the magnetic permeability of catalyst 6, the Lefort's oxide, made by precipitation with NaOH, is very much slower than that of either sample precipitated with  $\text{NH}_4\text{OH}$ . It will be noted in connection with Table I that catalyst 6, in spite of careful washing, was found to contain about .12% NaOH.

Effects produced by this impurity, or by a change in particle size with the precipitating agent, seem to be the most likely causes of the difference between the rate of change of magnetic permeability of catalyst 6, and that of either catalyst 2 or 4.

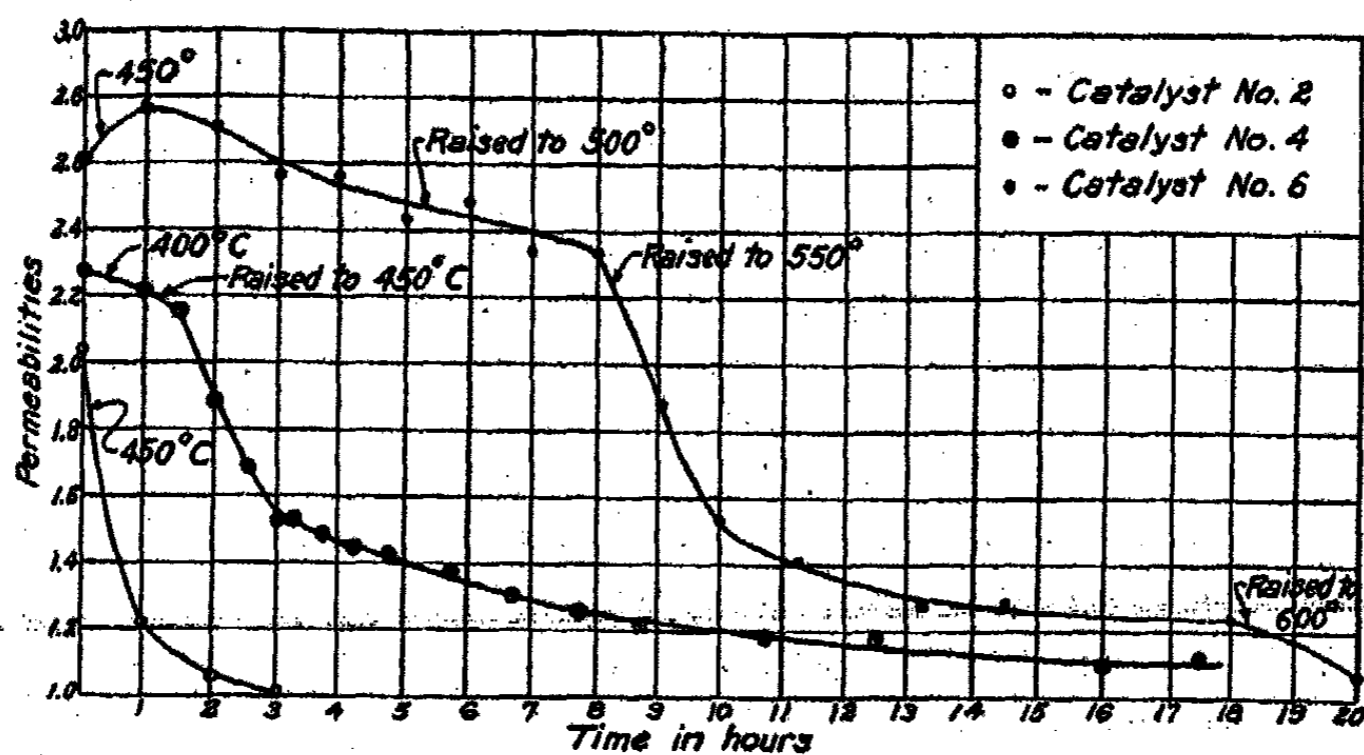

FIG. 4

The influence of promoter content and precipitating agent on the rate of decrease of permeability of cubic  $\text{Fe}_2\text{O}_3$  in the temperature range  $450^\circ\text{--}600^\circ\text{C}$ .

#### Reduction of Cubic and Rhombohedral $\text{Fe}_2\text{O}_3$

The comparative rates of reduction of the oxides, in a stream of 200 cc. of hydrogen per minute, were determined by a flow system similar to that described by Pease and Taylor. Hydrogen was purified by passage over hot copper and dried by passing through soda lime and  $\text{P}_2\text{O}_5$  tubes. The sample of oxide immediately before the reduction was dried to constant weight at  $270^\circ\text{C}$ . Water was determined in the exit gases by collecting it in  $\text{P}_2\text{O}_5$  tubes. The rate of reduction is expressed in terms of mgs. of water obtained per 5 minutes. The temperature of the sample was obtained from a calibrated thermometer thrust through the top of the furnace into the bed of catalyst. Typical sets of reduction curves are shown in Fig. 5 and Fig. 6. From Fig. 5a, 5b, and 5c, it is evident that the reduction rate curves for rhombohedral and cubic  $\text{Fe}_2\text{O}_3$  are qualitatively the same. Unfortunately, the difference in size of the two samples used makes a quantitative comparison between the two rates difficult. However, if due allowance be made for the size of the sample, one is led to the conclusion that the cubic modification reduces a little more rapidly than the rhombohedral. The same figures also show that the rate of reduction of the samples that had been heated to  $550^\circ\text{C}$  is very much smaller than that of those dried at  $300^\circ\text{C}$ . Thus samples 2a and 5a each reduces at a very much slower rate than do samples 2 and 5, respectively. Sample 6a also reduced at a somewhat lower rate than sample 6. However, since the few hours heating at  $550^\circ$  had but little effect on the magnetic

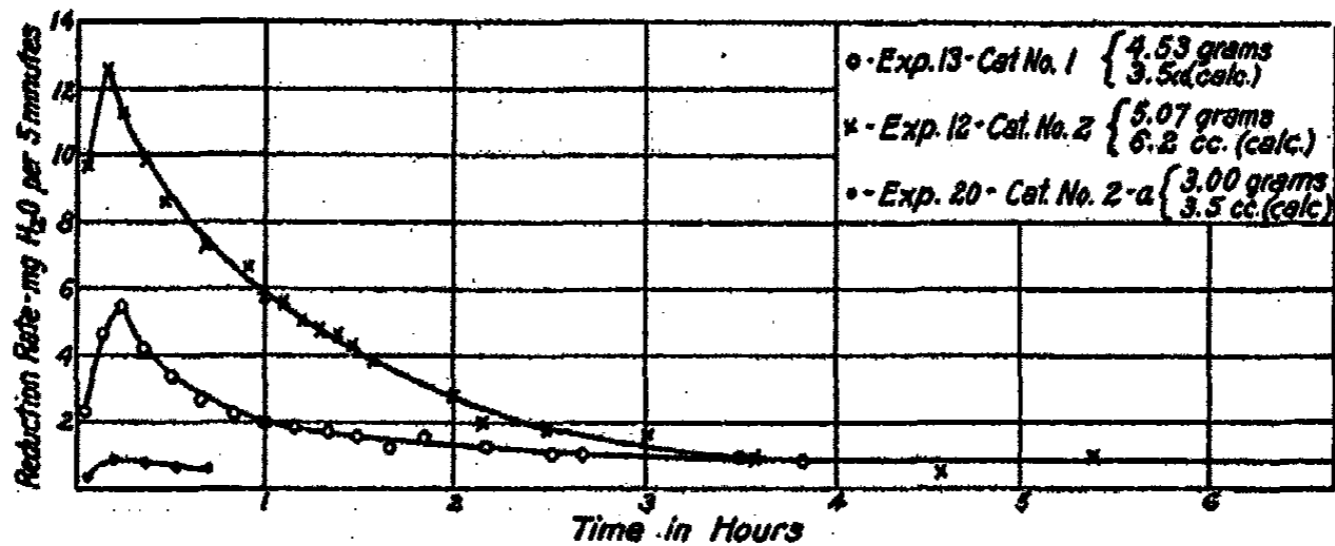

FIG. 5a

Rate of reduction by hydrogen of cubic and of rhombohedral  $Fe_2O_3$  at  $210^\circ C$ .

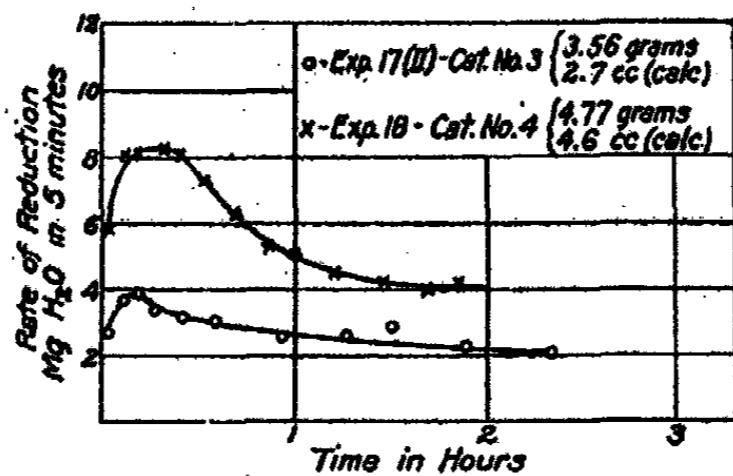

FIG. 5b

Rate of reduction by hydrogen of promoted cubic and rhombohedral  $Fe_2O_3$  at  $210^\circ C$ .

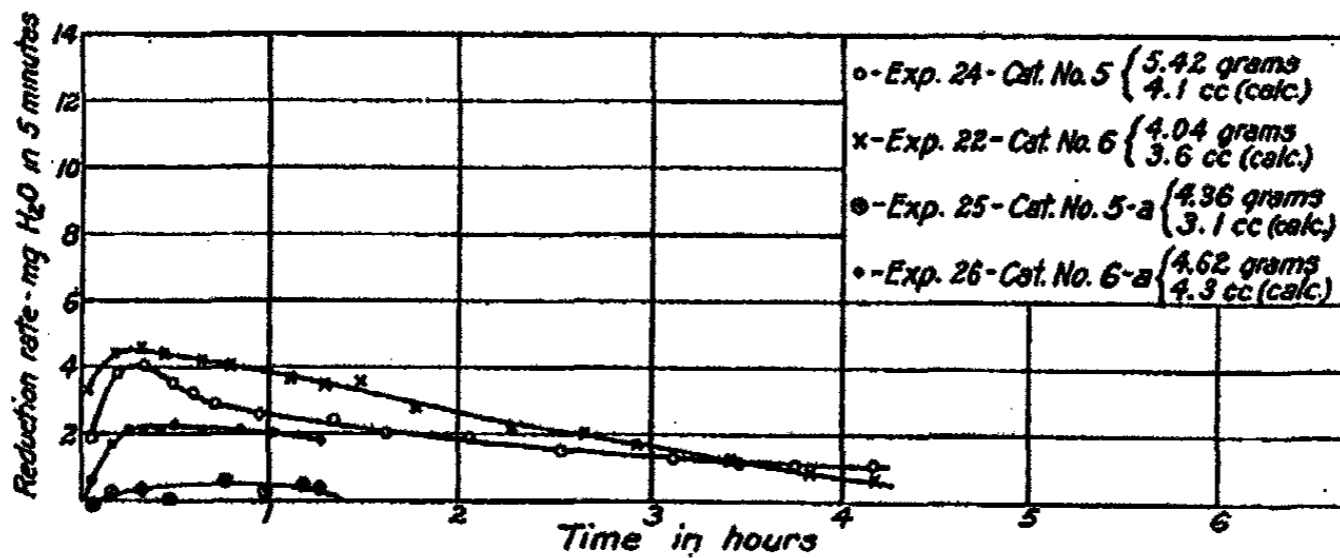

FIG. 5c

Rate of reduction by hydrogen at  $210^\circ C$  of cubic and rhombohedral samples of  $Fe_2O_3$  in the preparation of which NaOH was used.

permeability, crystal structure, or other characteristics of this catalyst, it was to be expected that its reduction rate would be affected less markedly than in the case of sample 2 or 5.

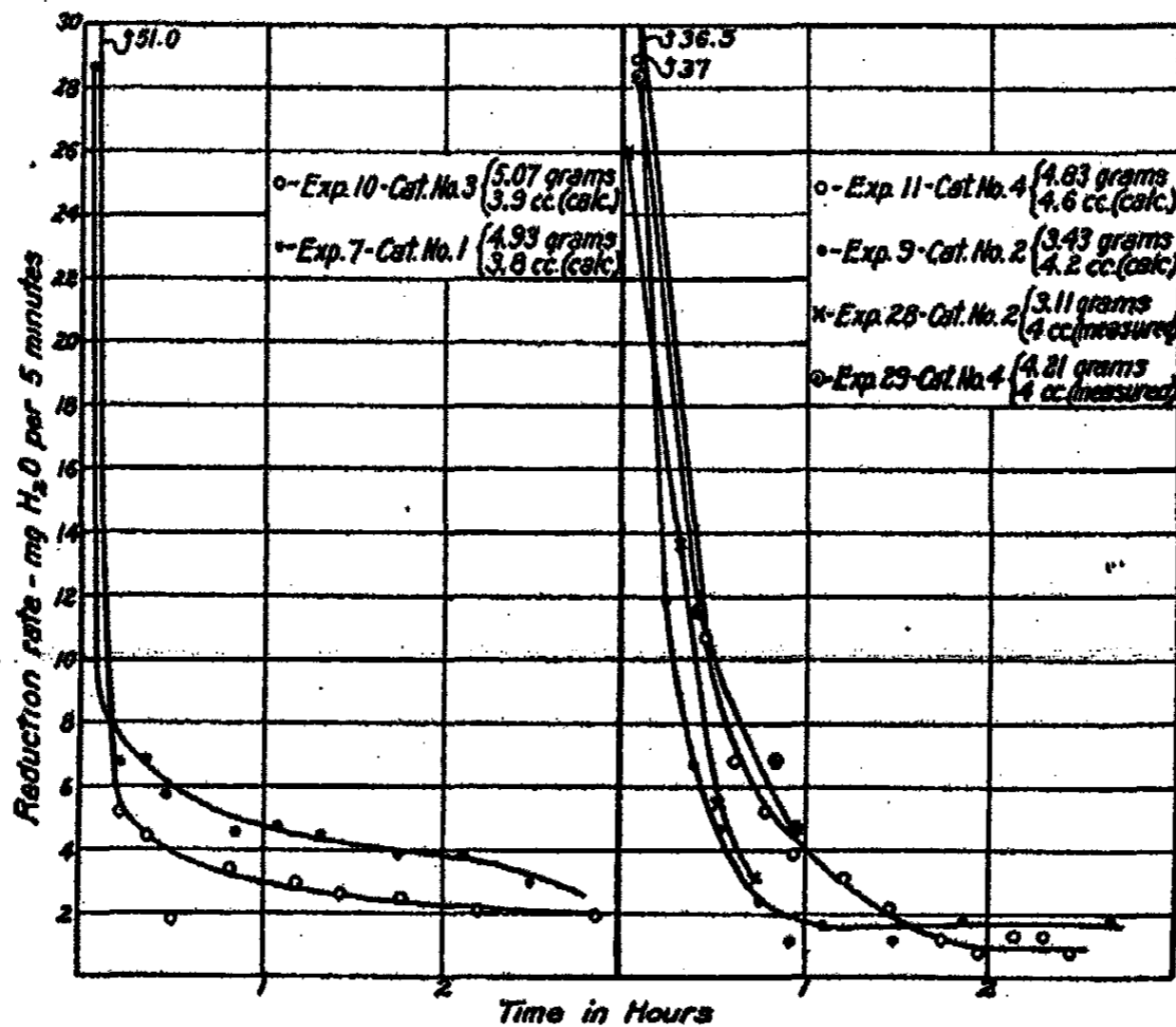

FIG. 6a

The influence of  $\text{Al}_2\text{O}_3$  on the rate of reduction by hydrogen of  $\text{Fe}_2\text{O}_3$  to  $\text{Fe}_3\text{O}_4$  at  $240^\circ\text{C}$ .

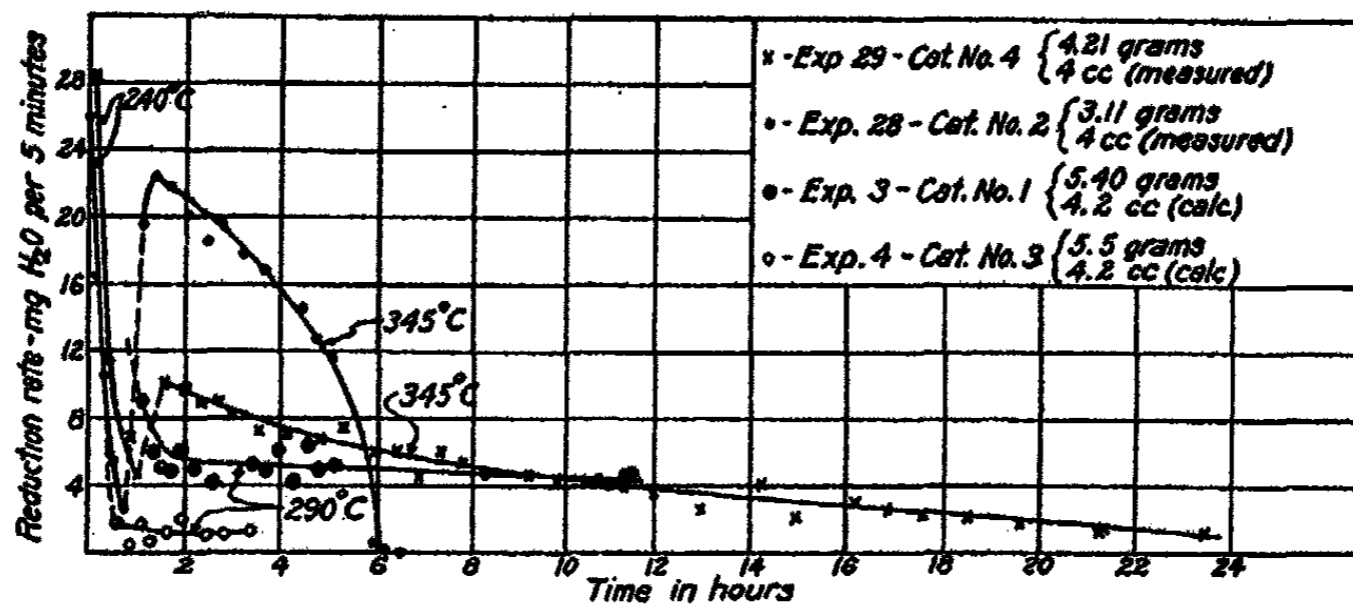

FIG. 6b

The influence of  $\text{Al}_2\text{O}_3$  on the reduction by hydrogen of  $\text{Fe}_2\text{O}_3$  to Fe.

Several reductions of cubic  $\text{Fe}_2\text{O}_3$  with and without the 1.5%  $\text{Al}_2\text{O}_3$  were run, first at  $240^\circ\text{C}$ ., and finally to completion at  $345^\circ\text{C}$ . The results of these runs are illustrated by typical examples in Figs. 6a and 6b. The reduction of  $\text{Fe}_2\text{O}_3$  to  $\text{Fe}_3\text{O}_4$  is changed but little, as shown in Fig. 6a, by the presence

of the  $\text{Al}_2\text{O}_3$ . On the other hand, as shown in Fig. 6b, the reduction of  $\text{Fe}_3\text{O}_4$  to Fe is very much slower for catalyst 4, containing the  $\text{Al}_2\text{O}_3$ , than for No. 2, the pure iron oxide catalyst. In this same figure, the curves for experiments 3 and 4 contrast the rate of reduction at  $290^\circ\text{C}$ . of  $\text{Fe}_3\text{O}_4$  to Fe without and with  $\text{Al}_2\text{O}_3$  present. Only the  $\text{Fe}_3\text{O}_4$  to Fe stage of reduction is shown for these two curves.

In all of the  $210^\circ$  iron oxide reduction curves it will be noted that the first few points at the beginning of each curve are lower than later ones. This is apparently caused by the rapid sorption by the dry oxide of water formed by reduction. The magnitude and rate of water sorption values on these oxides are such as to confirm this view.

#### Discussion of Results

It is difficult to offer an explanation or mechanism for the very marked decrease in catalytic activity toward the oxidation of benzidine or guajac resin by hydrogen peroxide produced by heating either cubic or rhombohedral  $\text{Fe}_3\text{O}_4$  samples to  $550^\circ$  or higher. The phenomenon can perhaps best be explained by merely postulating the sintering of points or regions of the catalyst surface usually catalytically active toward these reactions. It is difficult to exclude the possibility, however, that the effective catalytic agent in these two reactions might be some trace of inorganic salt, the quantity of which is too small to be detected analytically, and the effect of which is destroyed by heating to  $550^\circ$  or more.

Exposing catalyst 2 to a temperature of  $550^\circ\text{C}$ . for two hours (thereby converting it into what has been designated as catalyst 2a) produced interesting and unexpected results. The water sorption capacity of the sample was reduced by 50 to 75%, the rate of reduction by hydrogen by 75 to 90%, and yet the catalytic activity toward a mixture of hydrogen and oxygen remained unimpaired. Of course, it is well known that in general the surface of a catalyst as measured by the adsorption of a gas does not necessarily give information as to the extent of active catalytic surface. Furthermore, many cases are known in which heat treatment, or poisoning, of a catalyst reduces the catalytic activity markedly without materially affecting the capacity of the catalyst for adsorbing gases. However, the occurrence of the converse phenomenon, the decrease of "sorption" capacity of a catalyst without an attendant decrease in catalytic activity is very unusual. The decrease in the reduction rate of the oxide without a change of catalytic activity is similarly unexpected. The experimental facts are in agreement with the following explanation:

Each particle of the oxide (one mm. or so on a side, depending merely on the size of the screens used in preparing the original oxide) contains a certain number of pores and capillaries through which a free flow of gas does not take place. Such capillaries, therefore, would constitute a negligibly small part of the catalytic surface. However, both in the sorption of water and in the reduction by hydrogen, the capillaries would play an important

rôle. Accordingly, heat treatment sufficiently intense to decrease the number and size of the capillaries would at the same time markedly affect both the water sorption by and rate of reduction of the oxide. Though this explanation of the observed facts may not be the correct one, it is at least plausible and consistent with all data obtained.

It is of interest to compare the results obtained in the present work on the catalytic decomposition of ozone by  $\text{Fe}_2\text{O}_3$  with some observations made by Strutt.<sup>1</sup> He noted the rate of decomposition of ozone at low pressure over silver oxide and calculated that it corresponded to the decomposition of every molecule of ozone striking the silver oxide. If this calculation be correct, it follows that the temperature coefficient of the decomposition would be small. Since there seems to be no good reason for expecting the catalytic decomposition by silver oxide to differ markedly from that by ferric oxide, the low temperature coefficient and extremely fast reaction rate upon  $\text{Fe}_2\text{O}_3$  is not unexpected.

The temperature coefficient for the bimolecular homogeneous decomposition of ozone corresponds to an energy of activation, as calculated by the Arrhenius equation, of 30,000 calories per mol of ozone according to Wulf and Tolman.<sup>2</sup> The two thousand calorie apparent energy of activation for the catalytic decomposition is a much smaller fraction of the homogeneous value than is usual for catalytic reactions. Ordinarily, the temperature coefficient for the catalytic decomposition of a material is about one-half that of the homogeneous decomposition of the same reactant.

The part played by the  $\text{Al}_2\text{O}_3$  in catalyst 4, in decreasing the rate of change of magnetic permeability of a sample of cubic  $\text{Fe}_2\text{O}_3$  is not entirely clear. It seems quite probable that the phenomenon is similar to the retarding effect of  $\text{Al}_2\text{O}_3$  on the rate of growth of iron crystals in catalysts used for synthetic ammonia production<sup>3</sup> or to the retarding effect of  $\text{Al}_2\text{O}_3$  upon the rate of decrease of pyrophoricity of iron catalysts when the latter are heated at temperatures in the neighborhood of  $600^\circ\text{C}$ . as observed by Tammann<sup>4</sup> and his coworkers.

In conclusion, it is well to note one possible inference to be drawn from the oxide reduction work. Benton and Emmett<sup>5</sup> in studying the rates of reduction of  $\text{NiO}$  and of  $\text{Fe}_2\text{O}_3$  by hydrogen, found the former to be autocatalytic and the latter to be "non-autocatalytic." This result was interpreted as indicating the existence of solid solutions between  $\text{Fe}_2\text{O}_3$  and  $\text{Fe}_3\text{O}_4$  in accordance with Langmuir's<sup>6</sup> generalization that in such a reduction, the "active mass" of an oxide will be its total surface in case the two solid phases form solid solutions, but will be the interface between the two solid phases in case the solids form separate phases. However, x-ray crystal structure work would lead

<sup>1</sup> Strutt: Proc. Roy. Soc., 87A, 302 (1912).

<sup>2</sup> Wulf and Tolman: J. Am. Chem. Soc., 49, 1650-64 (1927).

<sup>3</sup> Wyckoff and Crittenden: J. Am. Chem. Soc., 47, 2866-76 (1925).

<sup>4</sup> Tammann and Nikitin: J. Russ. Phys. Chem. Soc., 56, 115-9; Nikitin: 121-7 (1925).

<sup>5</sup> Benton and Emmett: J. Am. Chem. Soc., 46, 2728-37 (1924).

<sup>6</sup> Langmuir: J. Am. Chem. Soc., 38, 2263 (1916).



us to believe that the formation of a series of solid solutions between rhombohedral  $\text{Fe}_2\text{O}_3$  and cubic magnetite is highly improbable. Accordingly, the present reduction work in which cubic  $\text{Fe}_2\text{O}_3$  is reduced, becomes of particular interest, since this latter material should be capable of forming a complete series of solid solutions with magnetite. With such a state of affairs, it is pertinent to inquire whether the reductions of rhombohedral and cubic  $\text{Fe}_2\text{O}_3$  exhibit any marked differences in the nature of the reduction curve. As can be seen in Figs. 5a, 5b and 5c, no appreciable difference in the nature of the two oxides is found to exist. This it seems can be interpreted as indicating either (1) that the removal of oxygen from the oxide is not the rate-determining step in the reduction, or (2) that  $\text{Fe}_3\text{O}_4$  forms solid solutions as rapidly and easily with rhombohedral  $\text{Fe}_2\text{O}_3$  as with cubic  $\text{Fe}_2\text{O}_3$ , or (3) that contrary to the inference usually drawn from Langmuir's hypothesis, reductions or heterogeneous reactions can be autocatalytic or non-autocatalytic regardless of whether solid solutions or separate solid phases are formed.

#### Summary

A comparison of some of the chemical and catalytic characteristics of cubic  $\text{Fe}_2\text{O}_3$  with those of rhombohedral  $\text{Fe}_2\text{O}_3$  has revealed the following facts:

(1) The catalytic activity of each of the two similarly prepared oxides, toward the oxidation of either benzidine or of guajac resin by hydrogen peroxide is approximately the same and is not, accordingly, a function of the crystal structure of the two oxides. Heating either cubic or rhombohedral  $\text{Fe}_2\text{O}_3$  to  $550^\circ\text{C}$ . for several hours practically eliminates their catalytic activity toward these oxidations.

(2) The catalytic activities of both rhombohedral and cubic  $\text{Fe}_2\text{O}_3$  are approximately the same at  $250^\circ\text{C}$  as measured by the rate of combination of a hydrogen-oxygen mixture on their surfaces. Heating either sample to  $550^\circ$  does not materially alter its catalytic activity toward this reaction.

(3) The catalytic decomposition of ozone at  $-74^\circ\text{C}$  occurs equally rapidly on the rhombohedral and cubic forms, but less rapidly on the highly heated material than on that dried at  $300^\circ\text{C}$  only. The decomposition of ozone in a 2% ozone-98% oxygen gas stream at an overall space velocity of about 180,000 to 200,000 is practically complete on the most active of the iron oxides, even at  $-74^\circ\text{C}$ . The reaction has a temperature coefficient corresponding to an apparent energy of activation of approximately 2000 calories. It approximates an apparent first order decomposition.

(4) The water sorption from a stream of nitrogen containing .57% water vapor has been measured at both  $25^\circ$  and  $210^\circ$ . The results show:

(a) The water sorption on a given weight of cubic  $\text{Fe}_2\text{O}_3$  is 10 to 60% less than that of the rhombohedral material.

(b) The sorption values on samples of the cubic and rhombohedral  $\text{Fe}_2\text{O}_3$  that have been heated for several hours at  $550^\circ\text{C}$ . are 75-80% less than on the samples dried at  $300^\circ\text{C}$ .

(4) The water sorption on a highly heated sample of  $\text{Fe}_2\text{O}_3$  is not increased by activation with a hydrogen-oxygen mixture.

(5) The loss of magnetic permeability on heating is most rapid for a cubic  $\text{Fe}_2\text{O}_3$  made from hydrated  $\text{Fe}_2\text{O}_4$  precipitated by  $\text{NH}_4\text{OH}$ , next fastest on a sample similarly prepared except that it contains 1.5%  $\text{Al}_2\text{O}_3$ , and slowest on the cubic  $\text{Fe}_2\text{O}_3$  made from hydrated  $\text{Fe}_2\text{O}_4$  precipitated by  $\text{NaOH}$ .

(6) The rates of reduction by hydrogen of the two types of  $\text{Fe}_2\text{O}_3$  are about the same, being a little faster for the cubic than for the rhombohedral forms. The rates of reduction are decreased by from 50 to 90% when either the cubic or rhombohedral form is heated to  $550^\circ\text{C}$ . for two hours.

(7)  $\text{Al}_2\text{O}_3$  precipitated with  $\text{Fe}_2\text{O}_4$ , and hence contained in the final cubic  $\text{Fe}_2\text{O}_3$ , has little effect on the rate of reduction of  $\text{Fe}_2\text{O}_3$  to  $\text{Fe}_3\text{O}_4$ , but seems to markedly retard the rate of reduction of  $\text{Fe}_3\text{O}_4$  to  $\text{Fe}$ .

In conclusion, the authors wish to express their thanks to Dr. Sterling B. Hendricks, for his kindness in taking the necessary x-ray powder photographs, to Mr. C. W. Gelhaus, for having analyzed all the oxides used in the present research, and to Dr. O. R. Wulf, for his many suggestions relative to the technique of producing and working with ozone.

## ON THE NATURE OF "ACTIVE" CARBON

BY H. H. LOWRY

22-22

Many papers<sup>1</sup> have been written on the nature of "active" carbon and the "activation" process. Practically all investigators have used for their measure of "activity" the adsorptive capacity of the carbon (charcoal) under certain arbitrary conditions.<sup>2</sup> In several previous papers<sup>3</sup> data have been given which indicate that the adsorptive capacity of carbon is increased by any process which increases either the total surface per unit weight or the degree of unsaturation of the surface atoms, or both. No exceptions to this generalization have been encountered. Since the adsorptive capacity is dependent on two factors which may be independently varied, it seems hardly logical to continue its use as a measure of the activity of carbon. Since it is generally recognized that the forces effective in adsorption processes are a result of the unsaturation of the surface atoms, the ratio of the adsorptive capacity to the total adsorbing surface would appear to be much more satisfactory for a measure of the activity. This measure would have general significance, however, only in the case of non-specific adsorption such as is characteristic of carbon; in other cases, the significance would be limited to the particular system considered.

Let us therefore define active carbon as a carbon which has a large adsorptive capacity per unit area of adsorbing surface rather than per unit weight. Then, of two carbons of equal adsorptive capacity per unit weight the carbon with the least surface would be the most active. An activation process would be limited, in accordance with the above definition, to a process which increases the degree of unsaturation of the surface atoms and would not include a process which simply increased the adsorbing surface. The data to be presented in this paper indicate the probability that treatment with corrosive gases at elevated temperatures does not influence the activity<sup>4</sup> but simply increases the extent of the adsorbing surface and that the activity is rather simply related to the number of atoms in each crystal fragment—the activity decreases as this number increases with the temperature of preparation above about 1000°.

<sup>1</sup> See for instance, E. G. R. Ardagh: *J. Soc. Chem. Ind.*, 40, 230T, 1921; G. A. Brender & Brandis: *Het Gas* 44, 5 (1923); N. K. Chaney and collaborators: *Trans. Am. Electrochem. Soc.*, 36, 91 (1919); *Chem. Met. Eng.* 28, 977 (1923); *Ind. Eng. Chem.*, 15, 1244 (1923); H. Chaumat: *La Nature*, 1926, 149; H. Herbst: *Kolloidchem. Beihefte*, 21, 1 (1925); P. Honig: 22, 345 (1926); W. Mecklenberg: *Z. angew. Chem.*, 37, 873 (1925); I. Ogawa: *Biochem. Z.*, 161, 275 (1924); 172, 249 (1926); A. B. Page: *J. Chem. Soc.*, 1927, 1476; O. Ruff and collaborators: *Kolloid-Z.*, 32, 225 (1923); 34, 135 (1924); 36, 23 (1925); 37, 270 (1926); 38, 174 (1926); *Z. angew. Chem.*, 38, 1164 (1925); *Ber.*, 60, 411, 426 (1927).

<sup>2</sup> The "retentivity" measured by Chaney, Ray and St. John: *Ind. Eng. Chem.*, 15, 1244 (1923), also belongs in this category.

<sup>3</sup> H. H. Lowry: *J. Am. Chem. Soc.*, 46, 824 (1924); *J. Phys. Chem.*, 29, 1105 (1925); 32, 1524 (1928).

<sup>4</sup> An exception to this might be expected for macrocrystalline graphite.

In order to determine the activity of a sample of carbon it is necessary, therefore, to be able to measure not only the adsorptive capacity but also the surface area. In any case the measure will contain a certain arbitrary quality since the adsorptive capacity must be determined under certain definite conditions. For these conditions we have chosen as most convenient the amount of carbon dioxide adsorbed by the carbon at  $0^{\circ}$  and atmospheric pressure expressed in cubic centimeters N.T.P. This choice may be given a definite significance in terms of the Polyani theory of adsorption.<sup>1</sup> By application of this theory to adsorption data, one obtains a curve characteristic of the system comprising the adsorbent and the surrounding atmosphere. This curve may be regarded as depicting the distribution of the force of attraction throughout the adsorption volume. Berenyi showed that this distribution is the same for the charcoals used by many different investigators when the adsorption volume is expressed in percent of the maximum adsorption volume. Berenyi's observation was supported by the data of S. O. Morgan cited by Lowry and Olmstead where the maximum adsorption volumes of the charcoals were in the ratio 1:10. It follows directly from these considerations that there must be a constant ratio between the amount of gas adsorbed at a given temperature and pressure by any charcoal to the maximum amount capable of being adsorbed by the same charcoal.<sup>2</sup> The choice of  $0^{\circ}$  and atmospheric pressure for determining the adsorptive capacity need therefore be justified only on the basis of convenience.

The simplicity of the method used for determining the adsorptive capacity is apparent from the following brief description. The temperature was controlled by an ice bath. Since other measurements have shown that a pressure change of several millimeters at atmospheric pressure does not change the amount of gas adsorbed by an appreciable percentage of that already adsorbed, it was not considered essential to accurately control the final equilibrium pressure to 760 millimeters, but only to the prevailing atmospheric pressure. Preliminary to making the adsorption measurements, the samples were evacuated at about  $200^{\circ}$  for 6 hours by means of a mercury diffusion pump backed up by a 2-stage mechanical pump of large capacity. The routine of measurement involved only customary procedure for this type of work and needs no detailed description.

In two previous papers<sup>3</sup> a method of determining the surface area of charcoal available for the adsorption of gases has been described. The values obtained by use of this method are in quite reasonable agreement with the values obtained for similar charcoals by other investigators who have used

<sup>1</sup> M. Polyani: *Verh. deutsch. physik. Ges.*, 16, 1012 (1914); 18, 55 (1916); *Z. Elektrochemie*, 26, 376 (1920); 28, 110 (1922); L. Berenyi: *Z. physik. Chem.*, 94, 628 (1920); 105, 55 (1923); *Z. angew. Chem.*, 35, 237 (1922); H. H. Lowry and P. S. Olmstead: *J. Phys. Chem.*, 31, 1601 (1927).

<sup>2</sup> This statement is limited to cases of surface attraction of a solid for a gas and does not include certain cases of the sorption of vapors where in addition to the surface phenomena there are involved purely surface tension effects, such as reduction in vapor pressure due to curvature of the surface of the liquid in the pores.

<sup>3</sup> *J. Am. Chem. Soc.*, 42, 1393 (1920); 46, 824 (1924).

other methods.<sup>1</sup> In the second of the two papers mentioned above, data were given for 23 samples for which the calculated surfaces ranged from 0.9 to 32.2 m<sup>2</sup>/gr. The total pore volumes for these same samples ranged from 0.9 to 44.8 cu. mm. per gram and the ratio of the surface to the pore volume from .49 to 0.83 with an average value of 0.69. The ratio of surface to volume would be constant only if the volume of each size of capillary formed the same percentage of the total pore volume for all the samples. The time necessary to determine the pore volume is only 10 to 20% of the time required for securing sufficient data to form a relatively significant estimate of the extent of the surface. This time factor is so considerable that it appeared more desirable to use pore volume as an approximate measure of the surface for a large number of samples rather than confine the investigation to a more detailed study of relatively few samples.

In our following discussion the pore volume is expressed as cu. mm. volume per gram and was determined as follows: the sample was evacuated for 6 hours at 200° to a high vacuum and then exposed to pure water vapor over a water reservoir consisting of a 1 c.c. pipette. The volume of water adsorbed could be read directly on the pipette to the nearest cu. mm. Care was taken to avoid condensation in other exposed parts of the apparatus. The absorption was followed with time until equilibrium was reached. In some cases this required a week or 10 days. Previous measurements have shown that the adsorption of water by carbon is strictly a capillary phenomenon<sup>2</sup> and therefore confidence may be had that the total water absorbed may be regarded as a measure of the total pore volume and within certain limitations also as an approximate measure of the total surface.

#### Preparation of Samples

All of the samples described in this study were prepared from a large lot of specially selected anthracite coal. The raw material was hand sorted so as to be as free as possible from slate, crushed, ground, sifted to 60-80 mesh, washed free from dust and carefully dried. The average ash content was 4.5% and the hydrogen content, as determined by ultimate analysis and corrected for ash and moisture content, was 2.10%. The subsequent treatment of the granulated coal was in two separate stages. The first stage was a preliminary carbonization in a controlled, dry, hydrogen atmosphere at a temperature below that used in the second stage in which the atmosphere was chosen to give different amounts of corrosion of the carbon granules.

For the "preroast" treatment the coal was placed in a heavy nichrome crucible of about one pound capacity. The crucible had gas inlet and outlet tubes through which commercial hydrogen, dried by bubbling through concentrated sulphuric acid, was passed continuously. When so loaded, the

<sup>1</sup> See for instance, A. M. Williams: Proc. Roy. Soc., 96A, 287 (1919); F. Paneth and A. Radu: Ber., 57, 221 (1924); E. K. Rideal and W. M. Wright: J. Chem. Soc., 127, 1347 (1925); W. E. Garner: J. Phys. Chem., 31, 641 (1927).

<sup>2</sup> H. H. Lowry and G. A. Hulett: J. Am. Chem. Soc., 42, 1393 (1920); A. S. Coolidge: 46, 596 (1924).

crucible was placed in the center of a nichrome-wound furnace of large heat capacity and the heating started. The temperature of the furnace was slowly raised to a maximum over a period of 14 hours, by mechanically decreasing a resistance in series with the furnace winding, and maintained at the maximum temperature for 3 hours when a time switch automatically shut off the current. At the end of 7 hours the crucibles were cool enough to withdraw and handle conveniently. The maximum temperature was controlled by a second adjustable resistance in series with the furnace. The temperature gradients were reduced due to the high thermal conductivity of the mass of metal forming the crucible. The first samples were all preoasted at a maximum temperature of  $800^{\circ} \pm 20^{\circ}$ . Later it seemed more logical to increase the preoast temperature to a value approximately  $100^{\circ}$  below the temperature used in the final treatment. However, an examination of all the data obtained, made at the end of the investigation, showed no effect on the final properties due to the differences in the preoast temperature. Since the preoast was essentially automatic in its operation, with accurate control of the variables involved, duplicate samples could be prepared with good reproducibility.

The second stage of the treatment, or the finishing operation, proved to be the important factor in determining the final properties. For this purpose a furnace of large heat capacity was designed having a platinum-rhodium resistor which was maintained at the desired temperature within  $\pm 5^{\circ}$  by a Wheatstone bridge controller-recorder<sup>1</sup> specially designed for this purpose by Leeds and Northrup Company. The furnace was mounted at a slight inclination. A tube of slightly smaller diameter passed coaxially through the furnace tube. This tube was mounted on mercury-sealed bearings and was free to rotate. The preoasted carbon was fed into the upper end of the rotating tube by a spiral feed integral with the mechanism used for rotating the tube and passed slowly through the furnace and was collected at the lower end of the tube. The furnace itself was 30" long with a length of 5" in the center where the temperature was a maximum with no temperature differences of more than  $\pm 2^{\circ}$ . With a speed of rotation of the tube of 1 rpm, the rate of flow of carbon through the furnace was  $35 \pm 3$  grams per hour and these conditions were maintained throughout this study. The gas inlet for admitting the gas chosen for the atmosphere was at the upper end of the furnace, the gas passing over the carbon in the same direction as its flow. The gases used were dry hydrogen, hydrogen of controlled humidity, carbon dioxide, air, and mixtures of these gases. The rate of gas passage was measured by an oil-filled "Precision" gas meter previously calibrated by direct volumetric measurement. With this assembly, the influence of the rate of gas flow was studied for the range approximately 0.1 to 1.0 cubic feet per hour. The final properties of the carbons were quite sensitive to the rate of flow of the gas when oxidizing gases were used as might be expected for the rate determined the amount of corrosion possible. The slow rotation of the tube made the

<sup>1</sup> See H. S. Roberts: *J. Wash. Acad. Sci.*, 11, 401 (1921); E. N. Bunting: *J. Am. Ceramic Soc.*, 6, 1209 (1923).

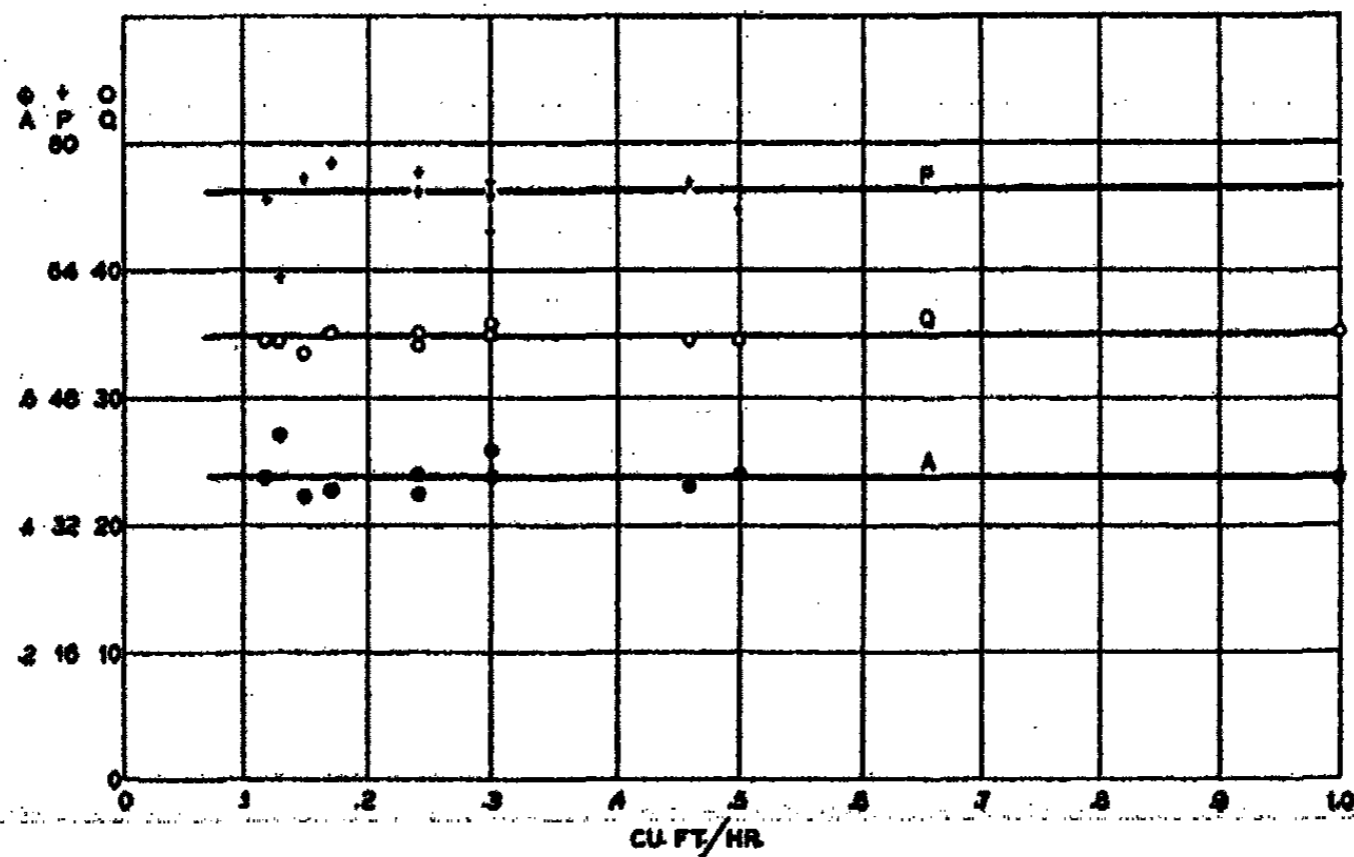

FIG. 1

Data obtained for samples prepared at a final maximum temperature of 900° in a hydrogen atmosphere, showing the independence of the adsorptive capacity (Q), pore volume (P), and activity ( $A = Q/P$ ) on the rate of flow of the hydrogen over the samples.

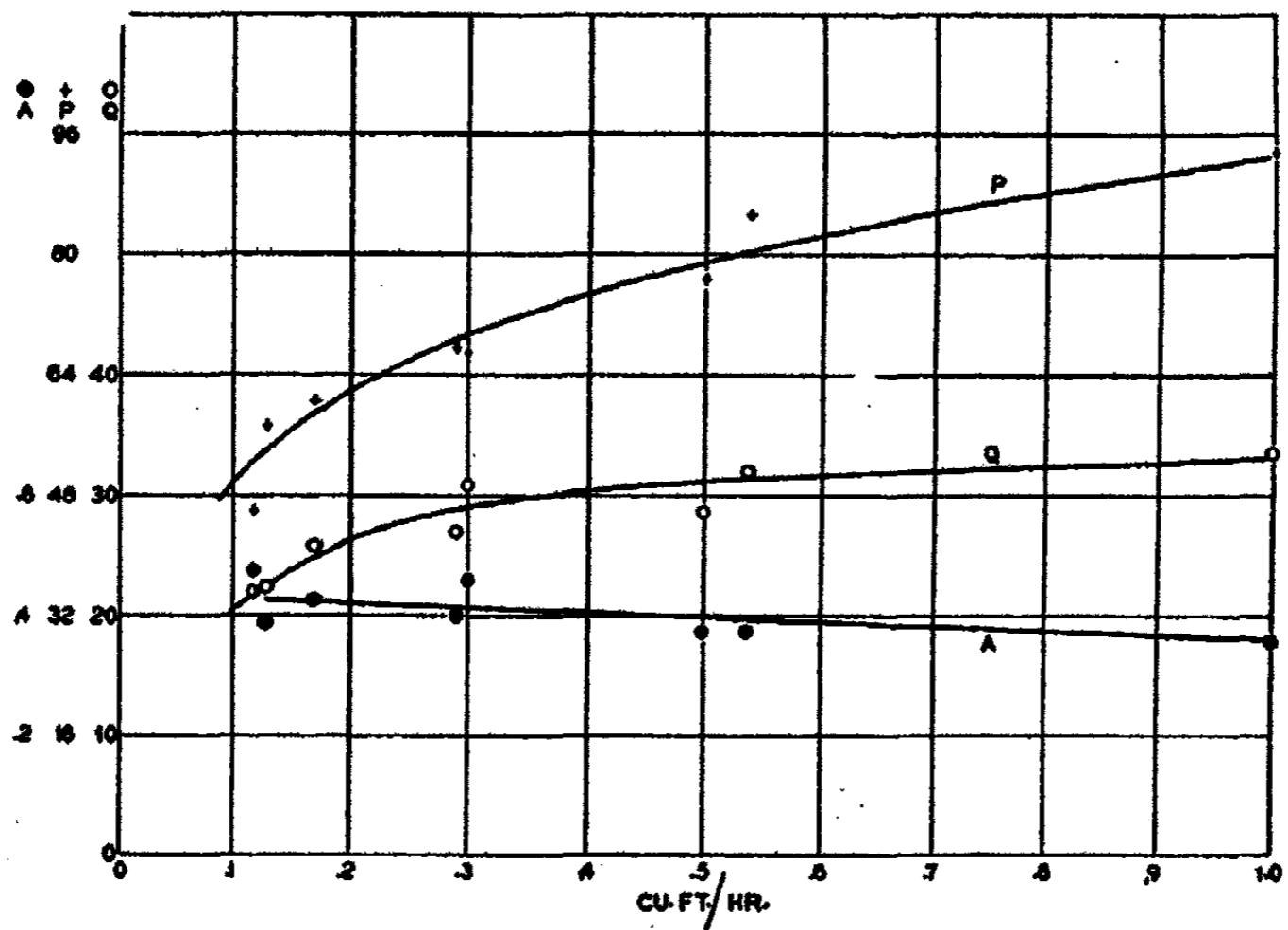

FIG. 2

Data obtained for samples prepared at a final maximum temperature of 1000° in a carbon dioxide atmosphere, showing the dependence of the adsorptive capacity (Q), pore volume (P), and activity ( $A = Q/P$ ) on the rate of flow of carbon dioxide over the samples.

surfaces of all grains equally accessible to the surrounding atmosphere and permitted satisfactory reproducibility of properties for samples prepared under the same conditions at long intervals of time.

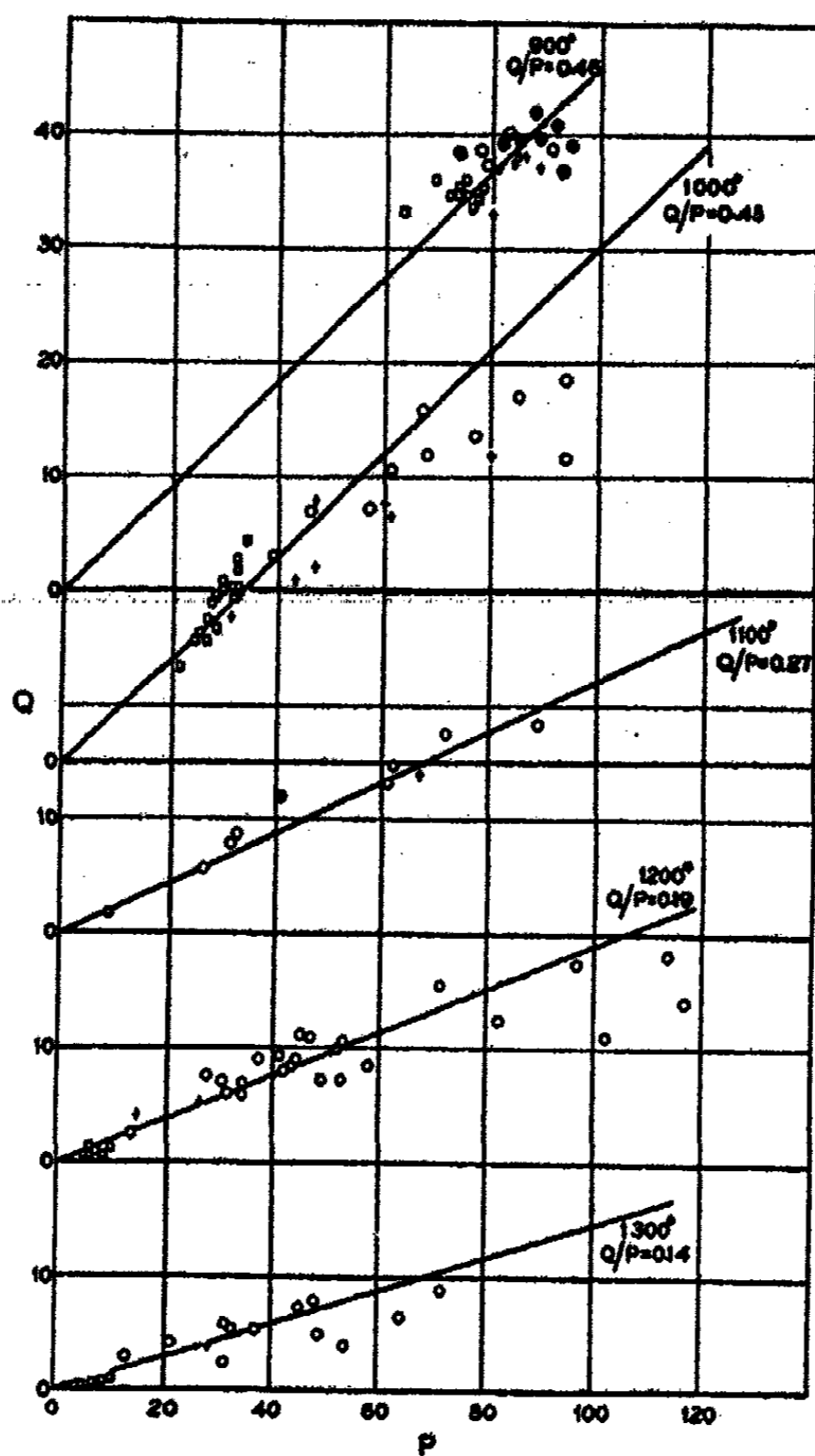

FIG. 3

Summary of data obtained for adsorptive capacity ( $Q$ ), and pore volume ( $P$ ) of samples prepared at temperatures of  $900^{\circ}$ - $1300^{\circ}$  in carbon dioxide ( $\circ$ ), hydrogen ( $\square$ ), air ( $+$ ), and air carbon dioxide mixtures ( $\oplus$ ).

#### Discussion of the Experimental Data

More than 200 samples were prepared for this study at final temperatures of  $900^{\circ}$ - $1300^{\circ}$  in the atmospheres previously enumerated. Since it is not intended to consider each sample separately, but only the relationships between different properties of groups of samples, the data will not be presented numerically but only graphically.

The influence of the rate of flow of gas on the adsorptive capacity ( $Q$ ), pore volume ( $P$ ), and the activity ( $Q/P = A$ ) of samples prepared at constant



temperature is shown by Figs. 1 and 2. For samples prepared in a hydrogen atmosphere, the data of Fig. 1 indicate quite definitely that these properties are independent of the rate of flow of gas. These data obtained on samples heated to a maximum temperature of  $900^{\circ}$  are typical of all the data obtained for samples prepared in hydrogen. Similarly, the relationships shown in Fig. 2 for samples prepared at a maximum temperature of  $1000^{\circ}$  in carbon dioxide are typical of all those prepared in oxidizing atmospheres. In this case both the adsorptive capacity and the pore volume increase considerably with the rate of flow of the gas over the carbon granules. The fact that the pore volume increases somewhat faster than the adsorptive capacity is reflected in the slight decrease in the activity. When, however, we consider the limitations of our measurement of the surface, i.e., the pore volume, it seems very probable that the adsorptive capacity per unit area of surface is actually constant and that the action of the carbon dioxide is not confined to increasing the surface by producing new capillaries, but in addition increases the average capillary diameter, thereby decreasing the ratio of pore surface to pore volume.

According to the views previously expressed in the literature, a treatment of charcoal in an oxidizing atmosphere at an elevated temperature has always been regarded as an "activation" process, increasing the "activity" of the carbon. The data presented in Fig. 2, and particularly in Fig. 3 indicate that this "activation" process results only in an increased surface available for adsorption, while the activity which, according to our determination, is the adsorptive capacity per unit area of surface, remains constant at any given maximum temperature of preparation. Fig. 3 is a graphical summary of the data obtained at  $100^{\circ}$  intervals from  $900^{\circ}$  to  $1300^{\circ}$ . The straight lines drawn represent constant activity for each temperature, the greater the slope the higher the activity.

It is recognized that the straight lines as drawn in Fig. 3 are somewhat arbitrary; but, considering the data as a whole, it is felt that the lines as drawn do best represent the data. There appears to be a tendency for the samples of greatest pore volumes and adsorptive capacity to fall below the lines drawn, i.e., to adsorb less gas than would be expected from the given measure of the surface. This is contrary to the usual interpretation of the activation process which attributes a higher "activity" to the surface atoms of a carbon "activated" by a process similar to that used here. However, when it is recalled that the increase in pore volume is probably accompanied by an increase in the average capillary diameter, and therefore by a decrease in the ratio of the pore surface to the pore volume, the smaller adsorptive capacity may be readily explained.

An interesting relationship may be observed if the data of Fig. 3 are re-plotted as in Fig. 4 where the slopes are plotted against the maximum temperatures reached by the samples in their preparation. Points are included on this curve for the intermediate temperatures of  $950^{\circ}$ ,  $1050^{\circ}$  and  $1150^{\circ}$ . Our measure of the activity, which we assume to be proportional to the amount of gas adsorbed per unit area of surface, appears to change very

slightly on increasing the temperature of preparation from  $900^{\circ}$  to  $950^{\circ}$  to  $1000^{\circ}$ . Above  $1000^{\circ}$  on the other hand, there is a regular and gradual decrease in the activity. These data afford a ready explanation for the commonly observed fact that the best adsorptive charcoals are prepared at  $1000^{\circ}$  or lower.

The maximum value of activity observed is 0.470. This is considerably less than the theoretical maximum which may be calculated according to the following considerations. The units in which the activity is expressed are cc. carbon dioxide at  $0^{\circ}$  and 760 millimeters per cu. mm. of pore volume. 1 c.c. of carbon dioxide under these conditions has a mass of 1.977 mg. The average density of a film of carbon dioxide adsorbed under the same conditions has been calculated to be 1.205 by use of the equation of state and the

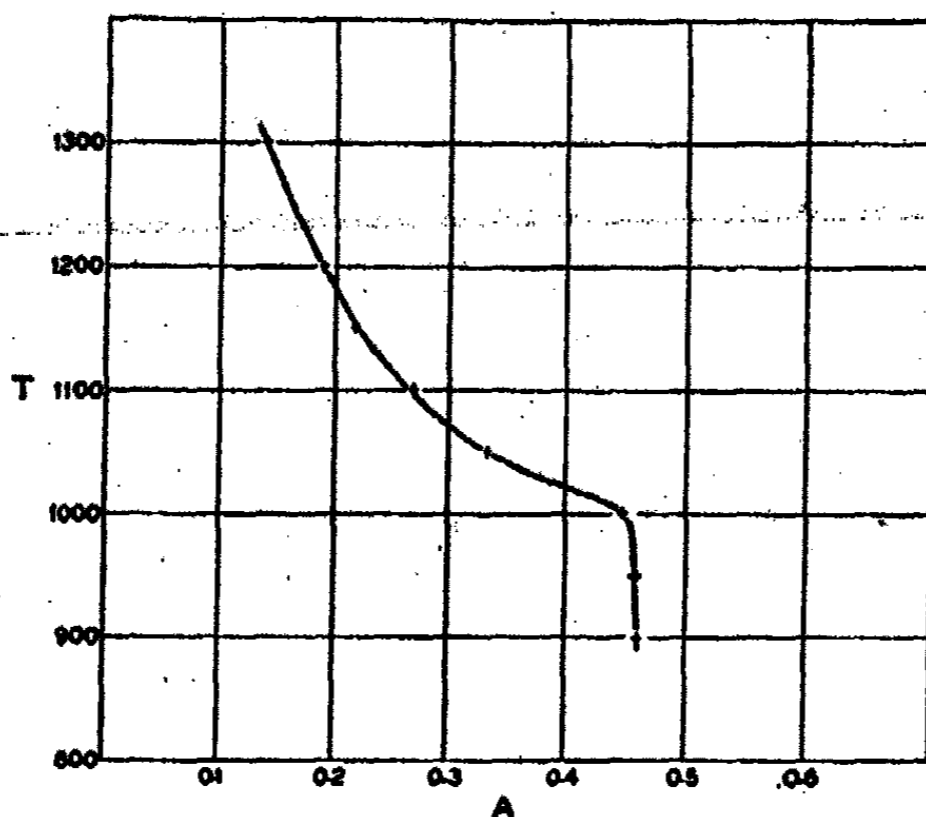

FIG. 4

A curve relating activity (A) to maximum temperature of preparation (T) for approximately 200 samples independent of the atmosphere used.

form of Polanyi's theory of adsorption given in the paper by Lowry and Olmstead. This density value means that 1 cu. mm. pore volume can contain as a maximum at  $0^{\circ}$  and 760 atmospheric pressure, 1.205 mg. of carbon dioxide or 0.610 c.c. The maximum observed value, 0.470, is only 77% of 0.610 and it therefore follows that not more than 77% of the pore volume is filled with adsorbed carbon dioxide.<sup>1</sup>

It has been previously pointed out that earlier measurements indicated a relationship between the adsorptive capacity of certain charcoals, all prepared similarly, and their hydrogen contents.<sup>2</sup> In a more recent paper<sup>3</sup> the

<sup>1</sup> A maximum value of 0.469 is obtained if use is made of a value of the density of the adsorbed carbon dioxide equal to 0.927 which is the density of liquid carbon dioxide at  $0^{\circ}$  under its own vapor pressure, i.e., 34.3 atmospheres. At one atmosphere the density of the free liquid should be less. There is, however, no justification for the use of such a value for an adsorbed film.

<sup>2</sup> Lowry: J. Am. Chem. Soc., 46, 824 (1924).

<sup>3</sup> J. Phys. Chem., 33, 1332 (1929).

dependence of the hydrogen content on the temperature of preparation has been emphasized. This dependence is clearly shown for the samples now being considered by an examination of Fig. 5 which is a repetition of the data of Table IV of the paper discussing the significance of the hydrogen content. The points on the figure represent the averages of all samples prepared at a given temperature, while the curve is drawn to fit the modified form of Equation 2-A given in Table IV of this previous paper, i.e.,

$$H = 2.10 \times 10^{-0.00000527(T-480)^{1.87}}$$

where  $H$  is the percent hydrogen content and  $T$  the maximum temperature of preparation. Except for the points at the two lowest temperatures, the agreement is within the experimental error, i.e.,  $\pm 0.02\%$   $H$ . The samples

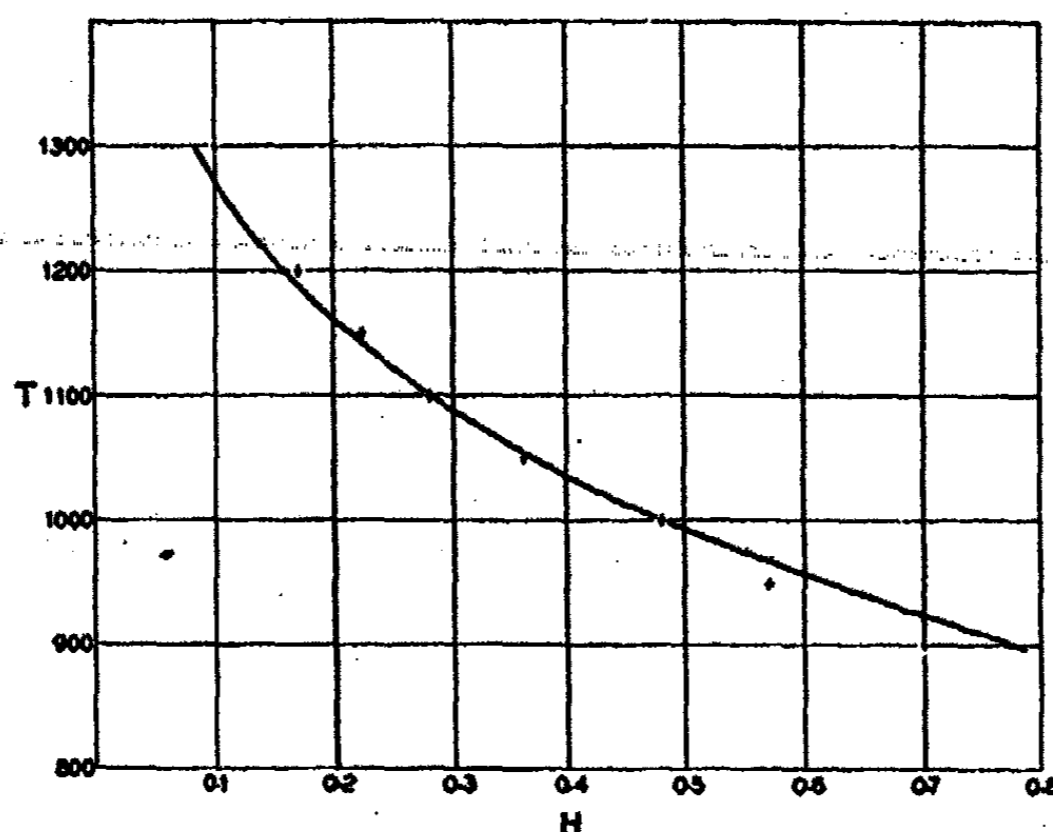

FIG. 5

Average hydrogen contents ( $H = \%$  hydrogen by weight) plotted against final maximum temperature of preparation ( $T$ ). Crosses are observed averages; the curve is calculated from theoretical considerations.

prepared at these lowest temperatures were among the first made and were prepared before it was appreciated that the use of an oxidizing gas raised the temperature of the carbon as much as  $25^\circ$  above that established with the furnace idle. For example, the average hydrogen content of the samples prepared in a hydrogen atmosphere at  $900^\circ$  is  $0.76\%$  compared with the calculated value of  $0.78\%$ , while the grand average including those prepared in carbon dioxide and air is only  $0.70\%$ .

When the data shown in Figs. 4 and 5 are combined with the elimination of the common temperature factor, Fig. 6 is obtained. In this figure a regular dependence of the activity on the hydrogen content is apparent, the activity increasing with hydrogen content to a hydrogen content of about  $0.5\%$  and then remaining approximately constant. That the flat part of the curve at the higher hydrogen contents extends much further to the right is indicated by the fact that the raw coal, having a hydrogen content  $2.1\%$ , still has an

activity of 0.470. The curve as drawn and the crosses are taken directly from the preceding two figures. There are also given 13 points slightly below the curve which were calculated from the same data (analyses of 104 samples) by the method of running averages, no consideration being given to the temperature of preparation. The same regular dependence of activity on hydrogen content is shown, though according to this method the activities corresponding to a given hydrogen content are somewhat lower.

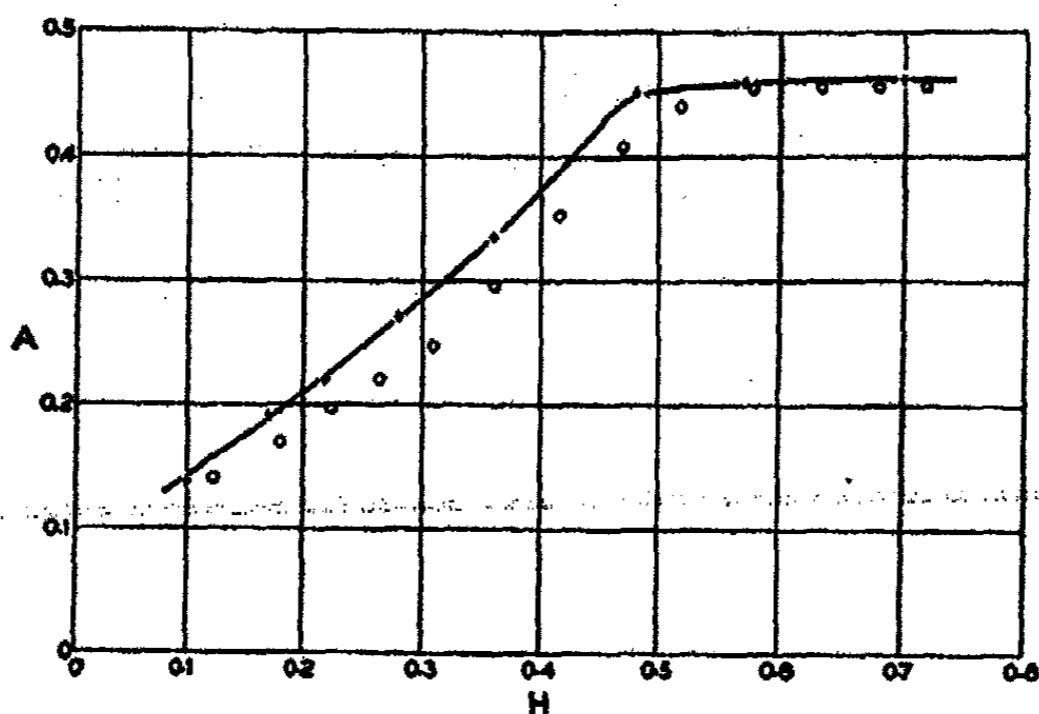

FIG. 6

A diagram representing the relationship between activity (A) and hydrogen content (H) for samples prepared at final maximum temperatures of preparation of 900°-1300°. The crosses are weighted averages, while the circles were obtained by a method of running averages.

#### Summary and Conclusions

The data shown graphically in the six figures of this paper show that starting with a given raw material, i.e., an anthracite coal, an increase in the temperature to which the material is heated above 1000° decreases the adsorptive capacity per unit pore volume. It is pointed out that the pore volume may be considered a measure of the extent of adsorbing surface and that the activity of an adsorbent carbon (charcoal) should be measured by the amount of gas adsorbed per unit area of its surface. The data, therefore, indicate that the activity of a charcoal is independent of the atmosphere in which it is prepared and dependent only on the maximum temperature to which it is heated. At any temperature between 900 and 1300° an increase in the adsorptive capacity is most probably accompanied by a proportional increase in the extent of the adsorbing surface. For example, although the adsorptive capacity of the samples prepared at 1100° ranged from 1.8 to 23.1 c.c. carbon dioxide per gram at 0° and atmospheric pressure, the actually measured values of activity ranged from 0.201 to 0.295, while the weighted averaged for all the samples prepared at the same temperature was 0.27: the variations observed are believed to be due to the limitations, which have been discussed, of the measure of the surface area rather than to a real difference in the activity. Whether the same numerical values of the activity

would be obtained if a different raw material were used has not been tested although the same orderly change in values would be expected.

In agreement with the fact previously shown that the hydrogen content of a charcoal decreases with increasing temperature of preparation, the data also shows a regular dependence of activity on hydrogen content for values of hydrogen content less than about 0.5% corresponding to a temperature of 1000°. For values of hydrogen content greater than 0.5%—probably extending to at least 2.1%—the activity appears to remain unchanged at a value 0.470 c.c. carbon dioxide adsorbed per cu. mm. pore volume at 0° and atmospheric pressure. That the simultaneous decrease in activity and hydrogen content above 1000° is to be attributed to a gradual crystallization of the carbon, as suggested in an earlier paper, is supported by the recent data of Else Koch-Holm.<sup>1</sup> In this earlier paper an explanation of the decrease of the hydrogen content with increasing temperature was based on such a crystallization. If crystallization does begin as soon as the temperature is raised sufficiently to decrease the hydrogen content, an idea which is supported by X-ray evidence,<sup>2</sup> it would be expected that the activity of the adsorbent would begin to decrease at the same temperature. Further, it is obvious that the minimum adsorptive activity should be evidenced by the plane surface of a perfect crystal. To explain then the constancy of the activity during the initial decrease in hydrogen content consistently with the above view would require the assumption that the decrease in activity due to the crystallization brought about by a rise in temperature was almost exactly counterbalanced by a rupture of the surface atoms by the hydrogen escaping as a result of the thermal decomposition. Also, according to this view, sufficient hydrogen will not be available at the higher temperatures to overcome the decrease in activity due to the progressive crystallization. Such an explanation is at best tentative. The mechanisms involved require much further study before a complete understanding may be reached.

*Bell Telephone Laboratories,  
New York City, N. Y.*

<sup>1</sup> *Wissensch. Veröffentl. Siemens Konzern*, 6, 188 (1927).

<sup>2</sup> See for instance, G. Asahara: *Japan. J. Chem.*, 1, 35 (1922); K. A. and U. Hofmann: *Ber.*, 59, 157 (1926); U. Hofmann: 61, 1180 (1928).

## ELECTROCAPILLARY PROPERTIES OF AMALGAMS

BY A. FRUMKIN AND F. J. CIRVES\*

Electrocapillary curves of dilute amalgams of different metals have been investigated by Rothmund,<sup>1</sup> Gouy,<sup>2</sup> and Christiansen.<sup>3</sup>

These investigators found that the maximum value of surface tension of these amalgams occurs at the same potential difference between solution and metal as is the case with pure mercury. On this basis it was often assumed that the position of the electrocapillary maximum is independent of the nature of the metallic phase. However, with a more concentrated amalgam of a Bi+Pb+Sn alloy, Gouy observed a marked shift of the maximum and a similar shift was found by Rothmund in the case of a thallium amalgam, but was ascribed to experimental errors caused by the action of the solution on the amalgam.

Frumkin and Gorodetzkaia<sup>4</sup> made an extensive study of the behavior of thallium amalgams in different solutions and found that the addition of the thallium causes a large shift of the maximum toward increased values of cathodic polarisation of the metallic surface. This shift may amount to as much as 0.45 volt for concentrated amalgams. Its value, although not quite independent of the nature of the solution, does not change very much with changes in the composition of the aqueous phase. The authors could show that it is possible to give a mathematical treatment of the curves observed on the basis of Gibbs' theory of surface equilibria. It follows from this theory that the electrocapillary curve of an amalgam must obey the same differential equation of Lippmann-Helmholtz which applies to a pure metal:

$$\frac{\partial \sigma}{\partial \phi} = E \quad (1)$$

In equation (1)  $\sigma$  is the interfacial tension at the amalgam-solution interface,  $\phi$  = the potential difference between solution and amalgam, and  $E$  is equal to the electric charge carried by the metallic ions which must be introduced in the solution (or removed from the solution if  $E < 0$ ) in order to keep  $\phi$  constant when the amalgam-solution interface increases by 1 sq. cm. The numerical values of  $\phi$  given in this paper are referred to the normal calomel electrode.

In the case of pure mercury, equation (1) has been tested by various methods:<sup>5</sup>

\* The work described in this paper is the basis of a thesis submitted by F. J. Cirves to the faculty of the University of Wisconsin in fulfillment of the requirements for a degree of Master of Arts.

<sup>1</sup> Z. physik. Chem., 15, 1 (1894).

<sup>2</sup> Ann. Phys., 9, 129 (1917).

<sup>3</sup> Ann. Physik, (4), 16, 382 (1905).

<sup>4</sup> Z. physik. Chem., 136, 451 (1928).

<sup>5</sup> Frumkin: Z. physik. Chem., 103, 55 (1922); Schofield: Phil. Mag., (6) 50, 649 (1926).

As far as we know no such experiments have been carried out with amalgams. It appeared desirable to supply this deficiency, as the shape of electrocapillary curve of amalgams presents a considerable theoretical interest and no treatment of the question is possible without the assumption of the validity of equation (1). The method applied was based on the use of the so-called "null solutions." According to Palmaer<sup>1</sup> and to Smith and Moss<sup>2</sup> a "null solution" is a solution in which the quantity  $E$  is equal to zero.

This means there is no ionic exchange between the metal and the solution when a fresh surface of the metal is formed. Therefore, an increase of the amalgam surface in a null solution does not change the concentration of the ions of the metal of the amalgam, and the potential difference between a dropping amalgam electrode and still amalgam must be equal to zero. Measuring the E M F of the cell: normal calomel electrode | null solution | amalgam, it is easy to find the value of  $\phi$  which corresponds to a zero value of  $E$  (point of zero charge). On the other hand, the value of  $\phi$  max, which corresponds to the maximum of the electrocapillary curve, where  $\partial\sigma/\partial\phi = 0$ , can be determined from measurements of interfacial tension. If equation (1) holds, the values of  $\phi$  as determined by these two methods must be identical. A comparison of the potential of pure mercury in various null solutions and of the corresponding positions of the electrocapillary maxima has been carried out by Smith and Moss. We have applied the null solution method also to the study of Cd amalgams for which there are no electrocapillary data available.

#### Experimental Method

In the course of this work, two types of apparatus have been used. The curves given by Fig. 3-6 have been taken with the apparatus represented in Fig. 1. In the earlier part of the work a vessel with a rubber stopper was used which proved to be not sufficiently air-tight for experiments with the more dilute amalgams. In other respects this first apparatus did not differ very much from the one finally adopted. With the first type of apparatus, the curves given in Fig. 2 were obtained. Each single experiment was carried out in the following manner. Approximately 160 ccm of the solution to be used were introduced in A and the amalgam placed in B. Then hydrogen was bubbled for about half an hour through the solution so as to remove the air. Using the stopcocks  $a$  and  $b$  it was possible to force a part of the hydrogen current to flow through C, D and D' and to displace the air from this part of the system. The hydrogen was supplied from a tank. It was purified by passing it over platinized asbestos heated to 500° and through an efficient wash-bottle filled with an alkaline solution of lead oxide. All connections between the asbestos tube and A were of glass but for a few short rubber connections which were completely under mercury. The rubber tubes used were always first boiled with alkali. During the bubbling of hydrogen, special care was taken to fill the narrow tube E with air-free solution. This was

<sup>1</sup> Z. physik. Chem., 59, 129 (1907).

<sup>2</sup> Phil. Mag., (6) 15, 478 (1908).

accomplished by opening the pinch-cock C from time to time, allowing the solution in A to flow through E. After the air had been removed in this fashion from the system, the amalgam was allowed to flow from B first to C and then into the tube DD'. When it reached a definite level in D it started to run through the capillary tip d in the solution. Moving the vessel C, it was possible to bring the amalgam in D always to the same level. The velocity of the flow of the amalgam was equal to about 25 cm per hour. It required but a few moments for the flowing amalgam to cover the surface of the platinum wire in the narrow tube E. As the time during which the

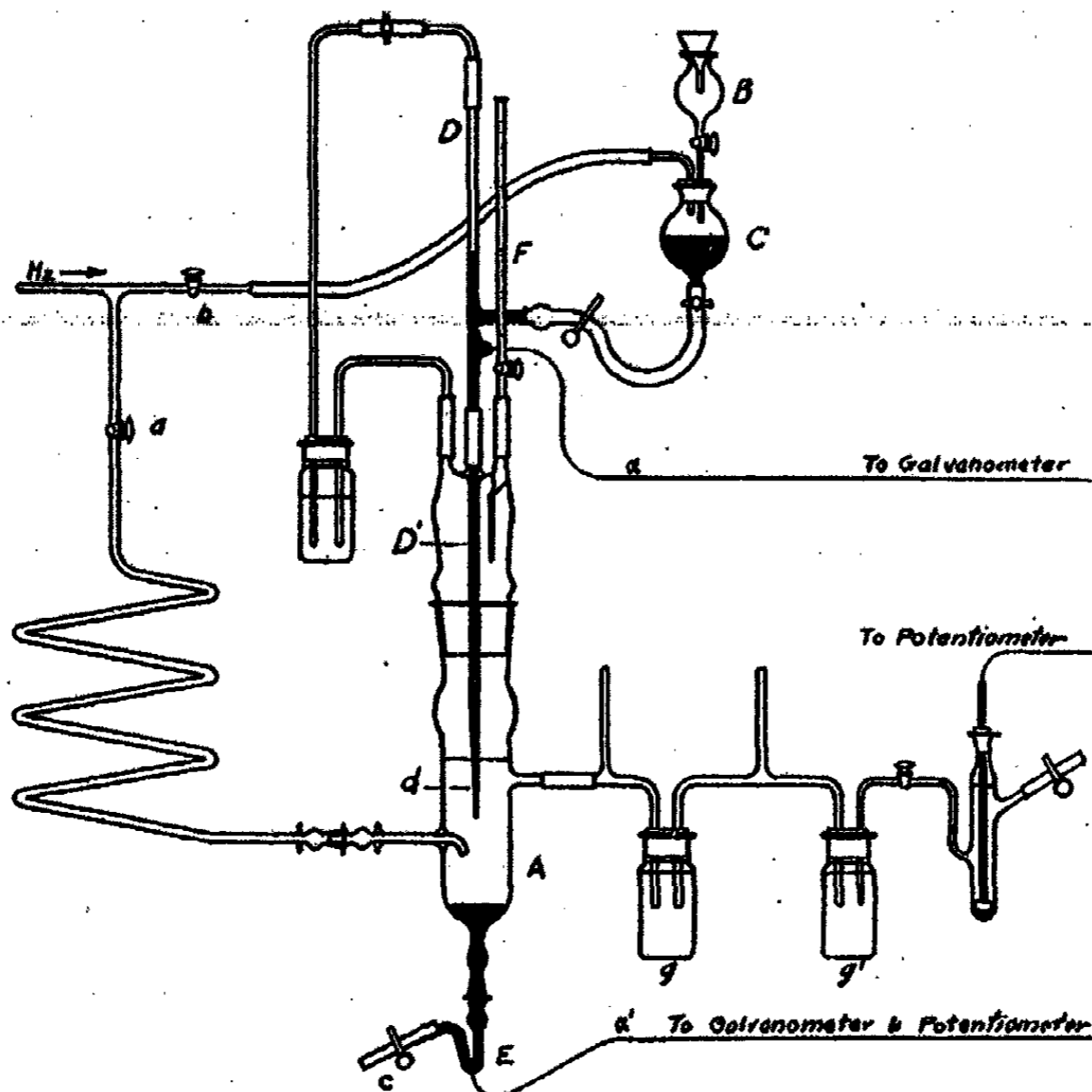

FIG. 1  
Dropping Electrode Apparatus

platinum was in contact with both amalgam and solution was very short, the possibility of a decomposition of the amalgam in contact with platinum was minimized. The burette F was filled with a 0.1 normal  $Tl_2SO_4$  solution in the case of Tl amalgams and with a normal solution of  $CdSO_4$  in the case of Cd amalgams. After the dropping electrode had been running for a while so that a large meniscus of amalgam was formed in the lower part of the vessel A, increasing amounts of the solution from the burette F were introduced into the vessel A. After each addition, the current flowing from the dropping electrode to the amalgam at the bottom of A and the potential difference between the solution and amalgam were determined. The current



was measured with a galvanometer which had its two poles connected with the wires  $\alpha$  and  $\alpha'$ . The current sensitivity of the galvanometer was equal to  $9 \times 10^{-8}$  amp. per division of the scale, and its internal resistance was 90 ohms. The current is said to be positive, if it flows in the outer circuit from  $\alpha'$  to  $\alpha$  ( $E > 0$ ) and negative in the reverse case. The potential difference  $\phi$  was determined by means of a potentiometer, whose poles were connected with  $\alpha'$  and the normal calomel electrode. The calomel electrode was con-

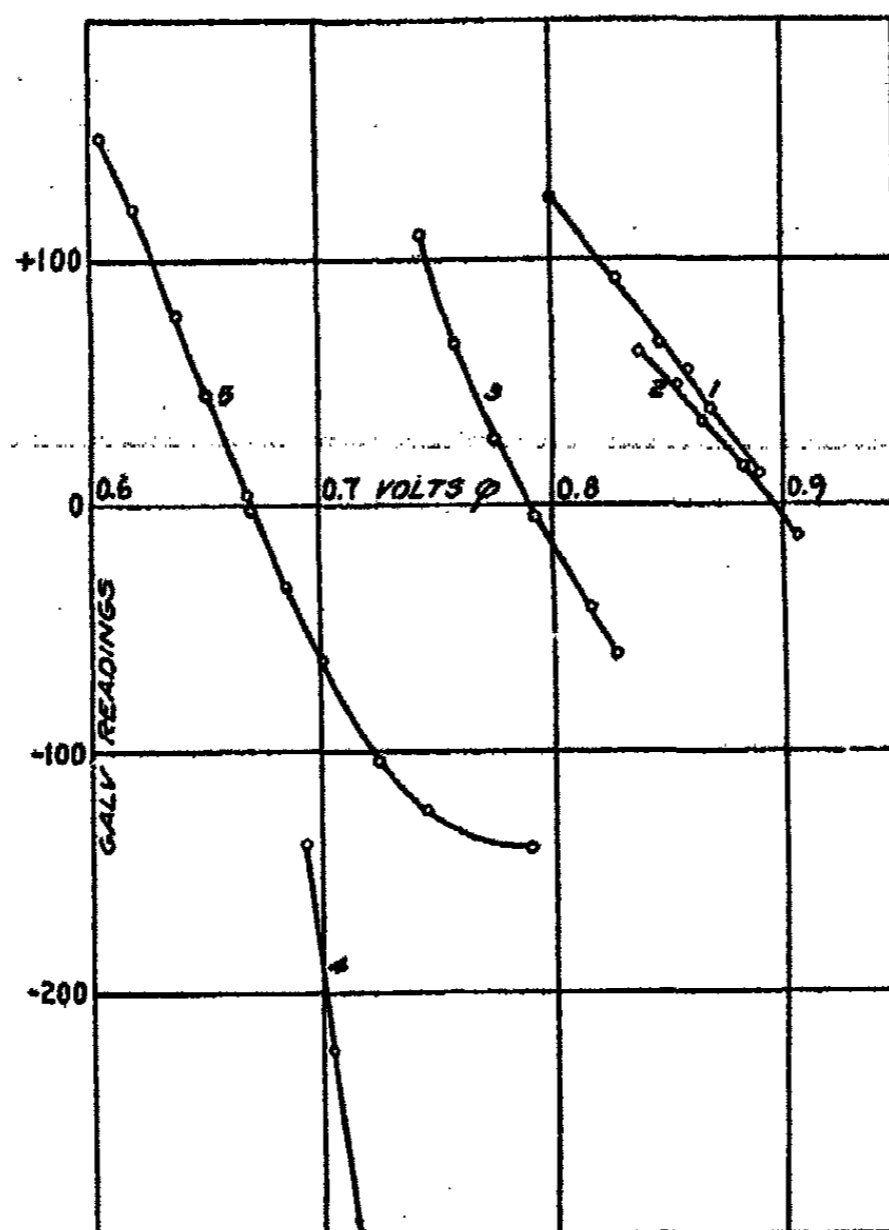

FIG. 2

Thallium Amalgams in Normal  $\text{Na}_2\text{SO}_4$  Solution

- Curve 1. 33% Tl amalgam in normal  $\text{Na}_2\text{SO}_4 + 0.1 \text{ H}_2\text{SO}_4 + \text{Tl}_2\text{SO}_4$ .  
 Curve 2. 33% Tl amalgam in normal  $\text{Na}_2\text{SO}_4 + 0.1$  normal  $\text{NaOH} + \text{Tl}_2\text{SO}_4$ .  
 Curve 3. 10% Tl amalgam in normal  $\text{Na}_2\text{SO}_4 + 0.1$  normal  $\text{NaOH} + \text{Tl}_2\text{SO}_4$ .  
 Curve 4. 10% Tl amalgam in normal  $\text{Na}_2\text{SO}_4$  saturated with iso-amyl alcohol +  $\text{Tl}_2\text{SO}_4$ .  
 Curve 5. 1% Tl amalgam in normal  $\text{Na}_2\text{SO}_4 + 0.01$  normal  $\text{H}_2\text{SO}_4 + \text{Tl}_2\text{SO}_4$ .

nected with the liquid in A by two syphons and two intermediate vessels. The syphons and the vessel g were filled with the same solution, which was introduced at the beginning of the experiment in A. The vessel g' was filled with saturated KCl solution.

An example of a typical determination is given in Table I.

The measurements of  $\phi$  present some difficulties at the beginning of a determination when the concentration of the ions, which determine the value of  $\phi$  is very low, since the potential of the amalgam electrode fluctuates

strongly in this region. Another disturbing influence observed under these conditions is that the potential of the amalgam becomes more positive (higher values of  $\phi$ ) when the droplets from the dropping electrode coalesce on its surface. This is of course what we must expect, as the quantity  $E$  in these solutions is negative, and the coalescence of droplets then causes a decrease of the concentration of the ions of the metal dissolved in the mercury. This will affect the potential of the amalgam electrode if the concentration of these ions is very low. This effect is observed only if  $\alpha$  and  $\alpha'$  are disconnected. If a connection between them is established, the current flowing through the circuit cuts down the changes of the concentration caused by the steady increase of the amalgam surface in the neighborhood of the dropping electrode and by its decrease of the surface at the bottom of one vessel. Therefore, the measurements of  $\phi$  had to be carried out without disconnecting  $\alpha$  and  $\alpha'$ . This precaution is no longer necessary after a few

TABLE I

0.1% Cd Amalgam, Initial Solution, Normal KBr.

ccm normal CdSO <sub>4</sub> added	$\phi$	galvanometer readings	ccm normal CdSO <sub>4</sub> added	$\phi$	galvanometer readings
0	0.807	-153	3.0	0.726	56
0.08	0.779	-89	4.0	0.722	50
0.2	0.763	-15	5.0	0.718	47
0.3	0.758	10	7.5	0.711	37
0.4	0.754	26	10.0	0.706	33
0.6	0.749	45	15.0	0.698	26
0.8	0.745	55	20.0	0.692	22
1.2	0.739	61	30.0	0.682	17
2.4	0.731	60			

tenths of a ccm of the solution from F have been added. Apparently, at higher concentrations, the relative change of the concentration of the ions, caused by the coalescence of droplets on the surface of the amalgam, is too small to affect its potential.

With very dilute amalgams it was observed that the precautions taken to exclude the oxygen from the system had not been quite sufficient. After an addition of larger amounts of the liquid from F (10 ccm. or more) values of the current were observed which could not be accounted for by the theory. It could be shown that these anomalies were caused by the oxidation of the amalgam by the oxygen dissolved in the solution in F which was not freed from air. This was evident from a comparison of the value of the current observed under the conditions described with the value which was observed when the same volume of the solution from F was introduced in A before the amalgam started to run and was then completely freed from air by bubbling hydrogen through it. In the latter case the anomalies mentioned above disappeared. Although the accuracy of the results which refer to the more

dilute amalgams would be increased if the solution in F had been freed from air, we do not believe that the zero point values given in this paper are vitiated by this source of error.

The mercury, which was used in the preparation of amalgams, was purified in the usual way with mercury nitrate. The cadmium was a Kahlbaum product of high purity and the thallium was obtained from Eimer and Amend. The latter contained about 0.15% of lead. The more concentrated amalgams were prepared by dissolving a known amount of the solid metal in heated mercury; the others were obtained by subsequent dilutions. In the case of amalgams which contained less than 0.1% Tl or Cd the dilution was carried out in the interior of the vessel C, after it had been filled with hydrogen, as it was found that the concentration of the dilute amalgams is very strongly affected by contact with air. If an amalgam which came through the liquid in A is poured from E into another vessel and then returned to B for another determination, the curve obtained in this case will always show a certain shift with respect to the original. The direction of the shift indicates a decrease of the concentration of the metal of the amalgam which must be caused by oxidation during the transfer of the amalgam from E to B. This effect becomes very pronounced with dilute amalgams. Such discrepancies between different runs are not observed if the amalgams are taken from one single stock or prepared under identical conditions.

#### Results: Tl amalgams

A part of the curves obtained with the more concentrated thallium amalgams are presented in Fig. 2. The values of  $\phi$  which correspond to a zero current are given in the second column of Table II. The values are averages from several determinations.

TABLE II  
Tl amalgams in normal  $\text{Na}_2\text{SO}_4 + 0.01$  normal  $\text{H}_2\text{SO}_4$ ,  
or normal  $\text{Na}_2\text{SO}_4 + 0.1$  normal  $\text{NaOH}$

% Tl.	Point of zero charge	$\phi$ max.
1.0	0.668	0.67
10.0	0.792	0.80 (10.3%)
33.0	0.898	0.92 (33.3%)

In the same table values of  $\phi$  max. taken from the paper of Frumkin and Gorodetskaya are given. As the uncertainty in the determination of  $\phi$  max may amount to as much as 0.01 or even 0.02 volt, the agreement between the two sets of data is satisfactory. The measurements of Frumkin and Gorodetskaya were carried out in the presence of small amounts of either  $\text{H}_2\text{SO}_4$  or  $\text{NaOH}$  and therefore the same additions were used here. Both methods show that the pH of the solution does not exert a marked influence on the value of the surface charge of the amalgam. The concentration of Tl ions at the zero point is very different for different amalgams. With the 33% amalgam it is too low to be determined directly. The amount of the Tl

present in the initial solution through oxidation of the thallium by traces of oxygen which could not be removed is of the same order of magnitude or even larger than the quantity which is necessary to bring the solution to the zero point. However, from the values of  $\phi$  which are observed at higher concentrations and from the position of the zero point, we may conclude that if the initial solution really contained no  $Tl_2SO_4$  at all, an addition of 0.04 ccm of 0.1 normal  $Tl_2SO_4$  would be sufficient to make a null solution. With a 10.0% amalgam this quantity as found now by experiment amounts

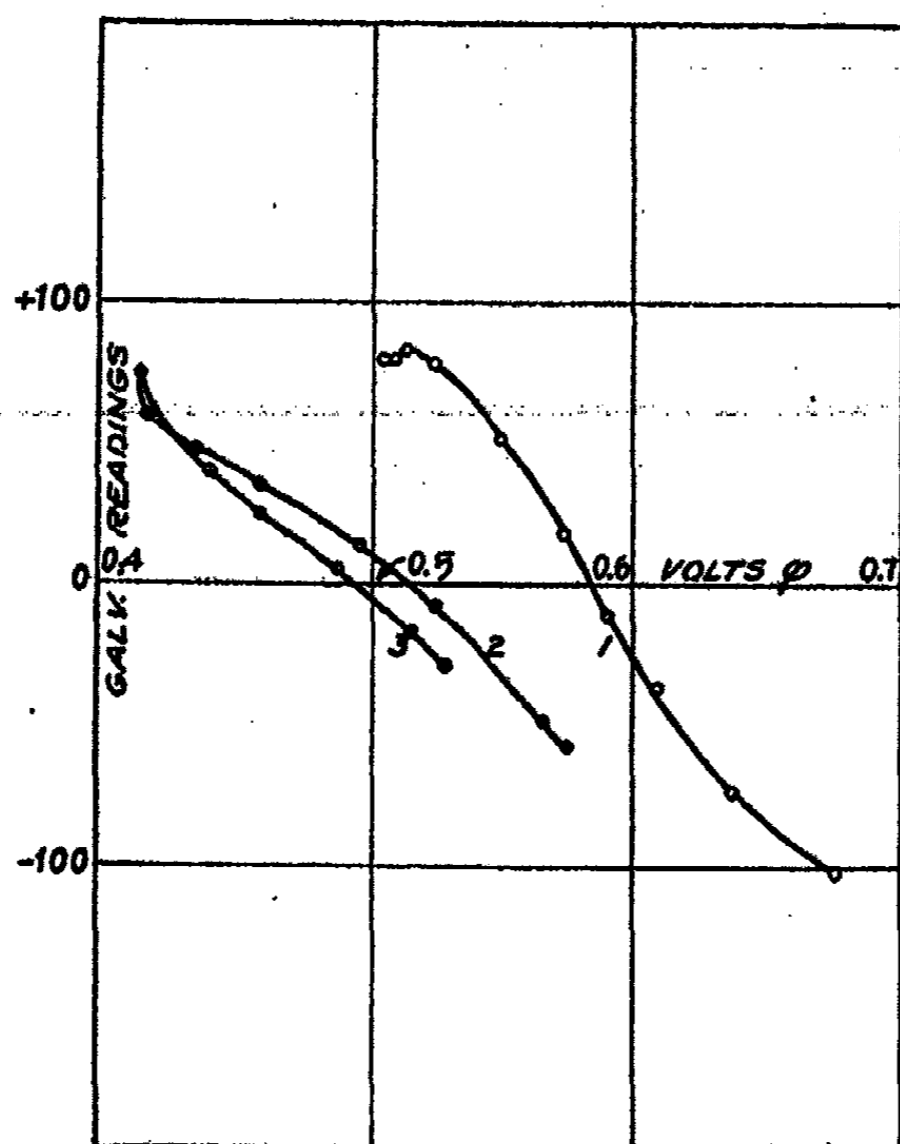

FIG. 3

Thallium Amalgams in Normal  $Na_2SO_4$  Solution  
 Curve 1. 0.1% Tl amalgam in normal  $Na_2SO_4 + Tl_2SO_4$ .  
 Curve 2. 0.01% Tl amalgam in normal  $Na_2SO_4 + Tl_2SO_4$ .  
 Curve 3. 0.001% Tl amalgam in normal  $Na_2SO_4 + Tl_2SO_4$ .

to about 0.2 ccm and for a 1.0% amalgam to 1.5 ccm. The latter value agrees very well with the result of the calculations of Frumkin and Gorodetzkaia.<sup>1</sup>

Curve 4 deserves special attention. It was shown by Gouy<sup>2</sup> that in the presence of amyl alcohol the maximum of mercury is strongly shifted toward smaller values of  $\phi$  and according to Frumkin and Gorodetzkaia the same thing holds for Tl amalgams. This result is corroborated by this curve, which shows that in the presence of amyl alcohol the current is negative over the whole range of the  $\phi$  values obtained. It is remarkable that the sign of

<sup>1</sup> Z. physik. Chem., 136, 459 (1928).

<sup>2</sup> Ann. Chim. Phys., (8) 8, 291 (1908).

the surface charge can be reverted as shown by curves 3 and 4, by the addition of a non-electrolyte which does not affect the concentration of Tl ions. A similar effect was recorded by Frumkin in the case of pure mercury on addition of ether to an alkaline solution.<sup>1</sup>

The curves obtained with more dilute Tl amalgams are given by Fig. 3. Their slope cannot be directly compared with the slope of the curves of Fig. 2 as the capillary tips in the first and the second apparatus were somewhat different. The positions of the point of zero charge are recorded in Table III. The value for pure mercury is taken from measurements of the electrocapillary curve of mercury in normal  $\text{Na}_2\text{SO}_4$  by Gouy<sup>2</sup> and by Frumkin and Gorodetzka.

TABLE III

Dilute Tl amalgams in normal $\text{Na}_2\text{SO}_4$			
% Tl	Point of zero charge	% Tl	Point of zero charge
0	(0.48)	0.01	0.513
0.001	0.494	0.1	0.585

The approximate compositions of the null solutions were: for 0.1% amalgam, 160 ccm  $\text{Na}_2\text{SO}_4$  + 2.5 ccm 0.1 normal  $\text{Tl}_2\text{SO}_4$  and for 0.001% amalgam, 160 ccm  $\text{Na}_2\text{SO}_4$  + 0.4 ccm 0.1 normal  $\text{Tl}_2\text{SO}_4$ . The approach of the position of the point of zero charge to the electrocapillary maximum of pure mercury as shown by Table III is very close to the 0.001% amalgam. Curve 1 of Fig. 3 shows a decrease of the intensity of the current when the concentration of Tl is increased beyond a certain limit (the smallest value of  $\phi$  corresponds to an addition of 70 ccm of 0.1 normal  $\text{Tl}_2\text{SO}_4$ .) This is (as will be shown in the case of Cd amalgams) a general phenomenon, which was probably not observed with other Tl amalgams only because the experiments had not been extended to sufficiently high concentrations of  $\text{Tl}_2\text{SO}_4$ . With the more dilute amalgams (0.01% and 0.001%) an opposite change of the direction of the curve is observed in the same region. As was explained in the preceding paragraph this is caused by the oxidation of the metal of the amalgam and has no real significance.

#### Cd Amalgams

The behavior of a 4.8% Cd- amalgam was investigated in different solutions of inorganic electrolytes. The results are given in Fig. 4. The positions of the points of zero charge given by Table IV are compared with the values taken from Gouy of  $\phi$  max for pure mercury in the same solutions. Table IV shows that an addition of cadmium to mercury shifts the point of zero charge in the same direction as an addition of Tl, the shift being the largest with the KCl solution and the smallest with KI solution. This is exactly what is observed with Tl amalgams if the values of  $\phi$  maximum in different solu-

<sup>1</sup> Z. physik. Chem., 103, 55 (1922).

<sup>2</sup> Ann. Chim. Phys., (7) 29, 145 (1903).

tions are determined. The zero point of the Cd amalgam in normal  $\text{Na}_2\text{SO}_4$  solution could not be reached by the addition of normal  $\text{CdSO}_4$  solution.

Another interesting phenomenon observed with cadmium amalgams is the decrease of the positive current at higher concentrations of  $\text{CdSO}_4$ .

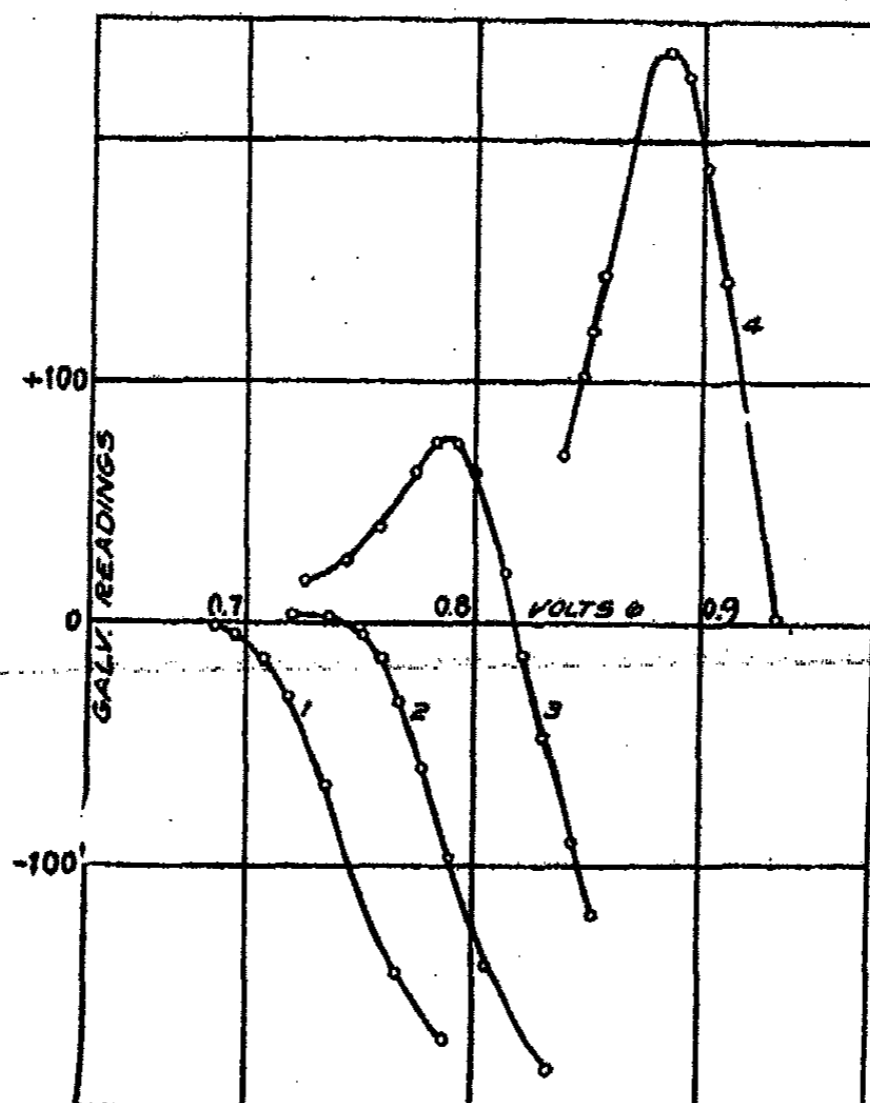

FIG. 4

- 4.8% Cd Amalgam in Different Solutions  
 Curve 1. 4.8% Cd amalgam in normal  $\text{Na}_2\text{SO}_4 + \text{CdSO}_4$ .  
 Curve 2. 4.8% Cd amalgam in normal  $\text{KCl} + \text{CdSO}_4$ .  
 Curve 3. 4.8% Cd amalgam in normal  $\text{KBr} + \text{CdSO}_4$ .  
 Curve 4. 4.8% Cd amalgam in normal  $\text{KI} + \text{CdSO}_4$ .

TABLE IV

4.8% Cd amalgam in different solutions

Solution	Point of zero charge	$\phi_{\max}$ for pure Hg
Norm $\text{Na}_2\text{SO}_4$	?	0.48
" KCl	0.746	0.56
" KBr	0.818	0.65
" KI	0.933	0.82

(curves 3 and 4). Although this effect could be observed with Tl amalgams too, it was certainly much less pronounced than with Cd amalgams. For instance, with normal KI the decrease begins after the addition of only 0.5 ccm of normal  $\text{CdSO}_4$  to the initial solution. It seems possible to account for this difference in the following manner. The decrease of the current at higher concentrations is caused by the diffusion of Cd ions. It is well known

that the same phenomenon is observed when mercury is flowing in a concentrated solution of  $\text{Hg}_2(\text{NO}_3)_2$ . Under these conditions there is no current between a dropping electrode and still mercury, although  $E$  has a high positive value. The influence of the diffusion can be explained in the following way. If a current has to flow between  $\alpha$  and  $\alpha'$  (Fig. 1) there must be a definite potential difference between the dropping electrode and the lower meniscus. The concentration of the ions of Cd (in the case of Cd amalgams)

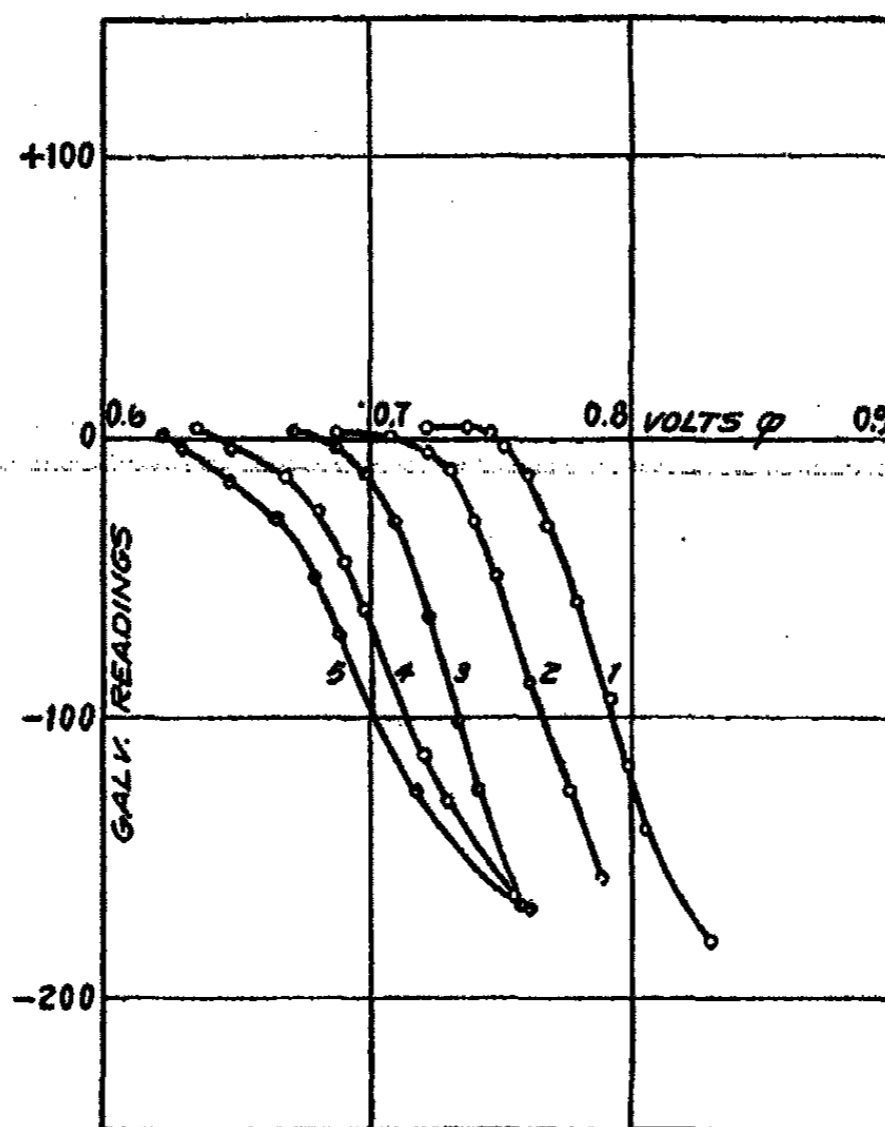

FIG. 5

Cadmium Amalgams in Normal KCl Solution  
 Curve 1. 4.8% Cd amalgam in normal KCl +  $\text{CdSO}_4$ .  
 Curve 2. 1.0% Cd amalgam in normal KCl +  $\text{CdSO}_4$ .  
 Curve 3. 0.1% Cd amalgam in normal KCl +  $\text{CdSO}_4$ .  
 Curve 4. 0.01% Cd amalgam in normal KCl +  $\text{CdSO}_4$ .  
 Curve 5. 0.004% Cd amalgam in normal KCl +  $\text{CdSO}_4$ .

must therefore be somewhat different in the vicinity of the dropping electrode and in the bulk of the solution, although the dropping electrode and the large meniscus are closely connected. The diffusion process will tend to cut down this difference of concentration and to correspondingly decrease the current. The difference in concentrations for a given current, (i.e. for a given potential difference) is very much larger for a divalent ion than for a univalent one, and therefore the influence of diffusion must be more marked with Cd amalgams than with Tl amalgams.

A series of more dilute amalgams have been investigated both in normal KCl and normal KBr. The data obtained are recorded in Figs. 5 and 6 and

in Table V. The determination of the zero point in KCl solutions with Cd amalgams is rather inexact on account of the low slope of the curve in this region.

The composition of the null solutions in the case of Cd amalgams does not change with change in the concentration of the amalgam in the same way as was observed with Tl amalgams. In order to reach the zero point with KBr it was necessary to add about 0.2 ccm normal CdSO<sub>4</sub> to the initial solu-

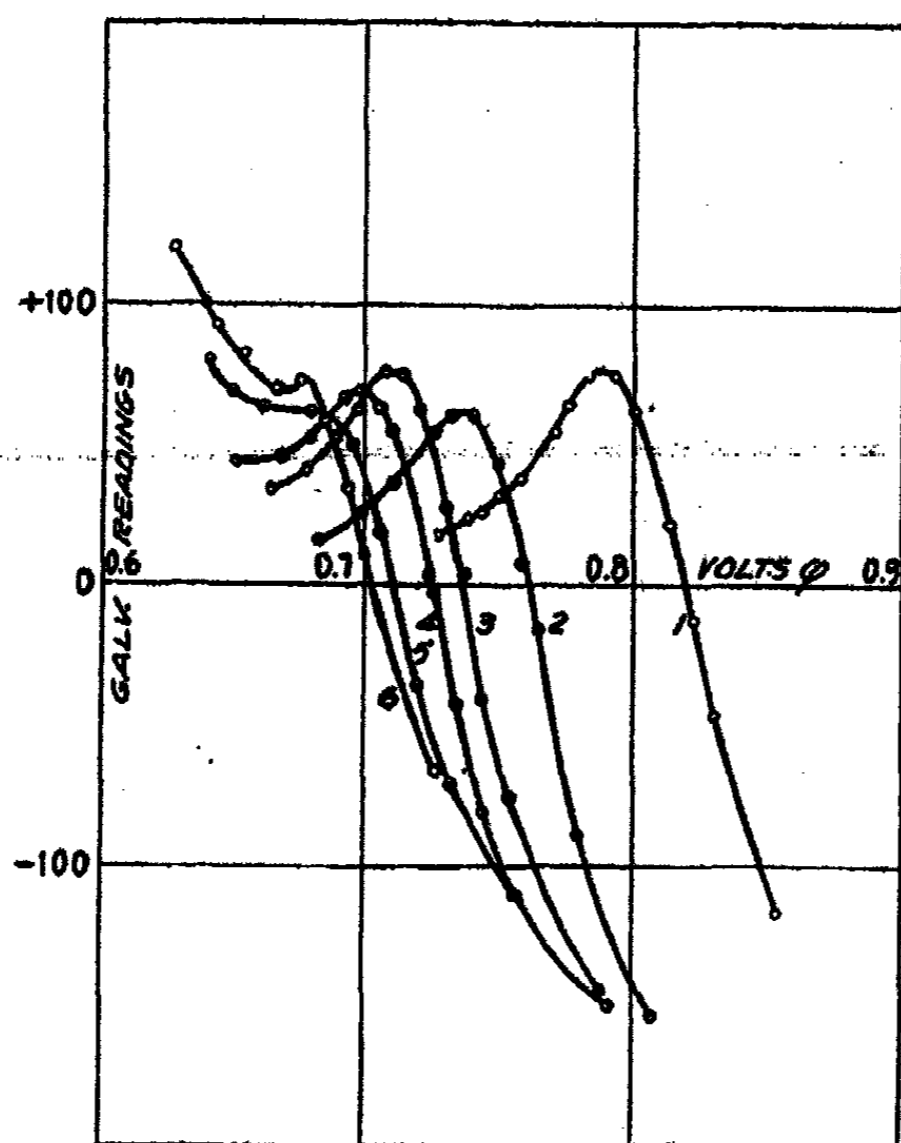

FIG. 6

Cd Amalgams in Normal KBr Solution	
Curve 1.	4.8% Cd amalgam in normal KBr + CdSO <sub>4</sub> .
Curve 2.	0.1% Cd amalgam in normal KBr + CdSO <sub>4</sub> .
Curve 3.	0.01% Cd amalgam in normal KBr + CdSO <sub>4</sub> .
Curve 4.	0.004% Cd amalgam in normal KBr + CdSO <sub>4</sub> .
Curve 5.	0.001% Cd amalgam in normal KBr + CdSO <sub>4</sub> .
Curve 6.	0.0003% Cd amalgam in normal KBr + CdSO <sub>4</sub> .

TABLE V

Cd amalgams in normal KCl and normal KBr					
% Cd	Point of zero charge KCl	Point of zero charge KBr	% Cd	Point of zero charge KCl	Point of zero charge KBr
0	(0.56)	(0.65)	0.01	0.640	0.736
0.0003	—	0.703	0.1	0.680	0.760
0.001	—	0.711	1.0	0.714	—
0.004	0.625	0.724	4.8	0.746	0.818



tion for all amalgams from 4.8 to 0.001%. With KCl the necessary amount of normal CdSO<sub>4</sub> fluctuated between 5 and 10 ccm for the more concentrated amalgams and 15 or 20 ccm for the more dilute ones.

The shift of the maximum persists with Cd amalgams at extremely high dilutions. We prefer to postpone the discussion of this interesting point until the results obtained here have been checked by determinations of  $\phi_{max}$ .

We have also made some determinations with Zn amalgams. The current was always negative, and on addition of ZnSO<sub>4</sub> a zero point could not be reached irrespective of the composition of the solution. The addition of ZnSO<sub>4</sub> caused a strong decrease in the intensity of the current, but this was probably connected only with the increase of the influence of the diffusion and not with the approach toward a zero point as practically the same curve was observed with different electrolytes and with amalgams which contained Zn in varying concentrations. It appears that there is no adsorption of Zn at the interface mercury/solution, therefore the presence of zinc does not influence the value of E. This conclusion must also be tested by electrocapillary measurements.

#### Summary

It was shown with the help of the "null solutions" method that an addition of Tl and Cd to Hg causes a shift of the point of zero charge toward higher values of the potential difference between solution and metal. The data obtained with Tl-amalgams check with the results of the determinations of electrocapillary maxima which confirms the validity of the Lippmann-Helmholtz equation in the case of amalgams.

*University of Wisconsin,  
Madison, Wisc.*

## THE FORMATION OF LYOPHOBIC ORGANOSOLS

BY HARRY B. WEISER AND GUILFORD L. MACK

When one considers the vast amount of work that has been done on hydrosols of the elements, salts and oxides, it is rather surprising to find that but few investigators have attempted to explore the realm of the corresponding organosols. One reason for this is doubtless to be found in the difficulty attending the preparation of pure organosols. It is the purpose of this paper (1) to classify the methods of formation of organosols stabilized by the adsorption of ions, (2) to survey the actual procedures employed in the past, and (3) to describe the preparation of a number of salt and oxide organosols by new and improved methods.

### Classification

The stabilization of a colloidal solution may be due to adsorption of ions, of liquid, or of another undissociated substance. The last two possibilities include the emulsions and protected colloids, the lyophiles, and will not be treated here. Considerations are thus limited to organosols stabilized by preferential adsorption of ions, corresponding to similar hydrosols. Such organosols show the greatest differences from aqueous sols and also among themselves, since with them the full effect of the abnormalities of the ionizing solvent comes in.

The known organosols stabilized by preferential adsorption of ions may be classified conveniently according to the process of formation. Like the corresponding hydrosols, the organosols may be prepared either by condensation or by dispersion methods. The classification according to the process employed to insure stability is given in Tables I and II.

Stabilizing factor	Condensation Methods	
	Known examples	Investigator
Selective adsorption of ions	Strong Adsorption	
	1. HgS in ethyl alcohol CuS in ethyl alcohol and ether	Lottermoser
	2. HgS and CuS in ethyl alcohol	Errera
	3. HgS in methyl and propyl alcohols	Weiser and Mack
	Low Concentration of Agglomerating Agent	
Dilution	1. As <sub>2</sub> S <sub>3</sub> in methyl alcohol	Gilbert and Mack
Replacement of dispersion medium	1. AgS and Au <sub>2</sub> S <sub>3</sub> in ethyl alcohol	Schneider

TABLE I (Continued)

Stabilizing factor	Known examples	Investigator
Choice of reaction		
a. No electrolyte formed	1. Ni in benzene and ether 2. Carbonates of Ca, Sr, Ba, and Mg in methyl alcohol 3. P in carbon bisulfide 4. S in carbon bisulfide and carbon tetrachloride 5. S in carbon bisulfide, benzene, alcohol and turpentine	Ostwald Buzágh Siedentopf Wiegand Amann
b. Electrolyte reacts with solvent	1. AgS in pyridine 2. CuS in pyridine 3. HgS in acetone	Pieroni and Tonnioli Naumann Weiser and Mack
c. Electrolyte is non-ionized	1. NaCl, KCl, Na <sub>2</sub> CO <sub>3</sub> , K <sub>2</sub> CO <sub>3</sub> , CuCl <sub>2</sub> , HgCl <sub>2</sub> , FeCl <sub>3</sub> in benzene, toluene and hexane 2. As <sub>2</sub> S <sub>3</sub> in nitrobenzene and aceto-acetic ester	Charitschkov Bikerman
d. Electrolyte is insoluble	1. Fe <sub>2</sub> O <sub>3</sub> , Cr <sub>2</sub> O <sub>3</sub> , and Mn <sub>2</sub> O <sub>3</sub> in propyl alcohol 2. Fe <sub>2</sub> O <sub>3</sub> in methyl alcohol	Weiser and Mack Weiser and Mack

TABLE II

## Dispersion Methods

Stabilizing factor	Known examples	Investigator
Addition of peptizing agent	1. As <sub>2</sub> S <sub>3</sub> in aniline 2. CdS in acetone 3. HgS in methyl and propyl alcohols	Bikerman Naumann Weiser and Mack
Removal of agglomerating agent	1. Prussian Blue, Cu <sub>2</sub> Fe(CN) <sub>6</sub> , Zn <sub>2</sub> Fe(CN) <sub>6</sub> in methyl alcohol	Weiser and Mack
Electrical Dispersion	1. All available metals in methyl, ethyl, propyl, butyl, and amyl alcohols; ethyl ether; acetone; ethyl and amyl acetate; chloroform	Svedberg and collaborators

### Formation by Condensation Methods

Hydrosols formed by condensation methods are usually grouped under two headings depending on whether the stability is due primarily to strong adsorption or to low concentration of agglomerating agent.<sup>1</sup> While there are examples which fit unmistakably under one or the other of these headings, both factors are present in the case of a great majority of hydrosols as well as organosols prepared by condensation, and it is often difficult to say which one predominates. For the purpose at hand, the ease of peptization is taken arbitrarily as the basis of classification. If the solid, once coagulated, can be re-peptized with an excess of the stabilizing electrolyte, the stability of the sol is attributed to strong preferential adsorption of ions; but if the solid phase cannot be redispersed in this way, the stability of the sol is attributed to low concentration of precipitating ions.

#### I. Strong Adsorption

Lottermoser<sup>2</sup> prepared mercuric sulfide sol in absolute ethyl alcohol by bubbling dry hydrogen sulfide into a solution of  $\text{Hg}(\text{CN})_2$ . He found the HCN to have a slight coagulating action and devised two methods for its removal: (a) dialysis in parchment or collodion bags against pure alcohol through which  $\text{H}_2\text{S}$  was passed continuously, (b) vacuum distillation in an atmosphere of  $\text{H}_2\text{S}$ . To prevent the rather concentrated sol (12 grams of  $\text{HgS}$  per liter) from setting to a gel it was necessary to maintain an excess of  $\text{H}_2\text{S}$  at all times in both purification processes. By a similar procedure copper sulfide sols were also prepared in ethyl alcohol and in ether, starting with solutions of copper acetate and copper glycol.

Errera<sup>3</sup> prepared a mercuric sulfide alcisol by a similar procedure. A preparation containing 2.5 grams of the sulfide per liter was found to be perfectly stable without purification. A stable copper sulfide alcisol containing 38.7 grams of copper sulfide per liter was prepared by conducting  $\text{H}_2\text{S}$  into an alcoholic solution of copper acetate. The stability of the sol without purification indicates the marked stabilizing action of the acetate ion. The low ionization of hydrocyanic and acetic acids in alcohol accounts for their weak coagulating action.

The formation of mercuric sulfide sols in methyl and propyl alcohols will be described in the experimental part of this paper.

#### II. Low Concentration of Agglomerating Agent

A low electrolyte concentration in the preparation of organosols is obtained (a) by dilution, (b) by replacement of solvent, (c) by choice of reaction such that (1) no electrolyte is formed, (2) the electrolyte reacts with the solvent, (3) the electrolyte is non-ionized, (4) the electrolyte is insoluble.

<sup>1</sup> Bancroft: "Applied Colloid Chemistry", 205 (1926).

<sup>2</sup> J. prakt. Chem., (2), 75, 293 (1907).

<sup>3</sup> Kolloid-Z., 32, 240 (1923).

*Dilution.* Sols whose stability is due to dilution of the electrolyte formed by a metathetical reaction are rare even among the hydrosols, and in the non-aqueous solvents, where the precipitation concentration of electrolyte for the sols is relatively low, the dilution necessary for stability must usually be too great for any practical purposes. Gilbert and Mack<sup>1</sup> obtained an  $As_2S_3$  sol in methyl alcohol by bubbling dry  $H_2S$  into a saturated solution of  $As_2O_3$ . The sol was clear yellow both in transmitted and reflected light. The solubility of the oxide in alcohol appears to limit the concentration of this sol to about 0.6 gram of  $As_2S_3$  per liter, since a higher concentration could not be obtained in the presence of excess of the solid oxide. This is probably due to the fact that the film of sulfide formed on the surface of the oxide is not reprecipitated by hydrogen sulfide.

While the stability of this sol might conceivably be attributed to strong adsorption or to non-ionization, it seems to fit better under the heading of dilution. Selective adsorption is undoubtedly responsible for the negative charge, but the low coagulation concentration of salts shows the adsorption to be very weak. As already noted, the coagulated sulfide cannot be reprecipitated with an excess of hydrogen sulfide under any circumstances. As regards the ionization of the hydrogen sulfide, it is probably about as high in methyl alcohol as in water.

*Replacement of solvent.* In this method the material is obtained in the colloidal state in one medium which is subsequently displaced by another. Hence the original sol may be formed either by a condensation or a dispersion method. Schneider<sup>2</sup> prepared hydrosols of Ag,  $Au_2S_3$ , and  $Au_2S_2$  and dialyzed them against pure alcohol using a parchment membrane. After 26 days the water content of the sol was less than 1 per cent.

*Choice of reaction. 1. No electrolyte formed.* Among hydrosols, Kolschütter's silver sol formed by reduction of a solution of silver oxide with hydrogen, is the classical example of this type. Walther Ostwald's<sup>3</sup> nickel sol in benzene deserves a similar place among organosols. Nickel carbonyl dissolved in benzene decomposes at the boiling point with evolution of carbon monoxide and the formation of a violet-blue gray suspension of metallic nickel. The sol is sensitive toward heat. A sample of the freshly boiled sol was partially coagulated after twelve hours standing but a carefully heated sample remained suspended two days. Ether sols were obtained in the same way and were claimed to be perfectly stable toward heat, even after diluting with benzene and alcohol. Hatschek and Thorne<sup>4</sup> question Ostwald's statement as to the stability of the latter sol since they found it necessary to use rubber as a protecting agent. It seems likely that the rate of decomposition of the carbonyl would be greater if the CO was removed as fast as formed by the bubbles of vapor in a boiling solution. Since the sol tends to be coagu-

<sup>1</sup> Unpublished results.

<sup>2</sup> Ber., 25, 1164 (1892).

<sup>3</sup> Kolloid-Z., 15, 204 (1914).

<sup>4</sup> Proc. Roy. Soc., 103, A, 276 (1923); Kolloid-Z., 33, 1 (1923).

lated by heat it is easy to understand why a lower-boiling dispersion medium, like ether, would produce a more stable sol, provided other factors influencing the stability remained constant. Since nickel carbonyl is extremely volatile and some of it is lost in the benzene vapors, Hatschek and Thorne used toluene which has a higher boiling point. They found the dissociation to be less complete in this solvent at 100° than at the boiling point of benzene, 80°. They were puzzled by this apparently anomalous behavior but it is exactly what one would expect if the above hypothesis as to the rate of decomposition is correct.

Neuberg<sup>1</sup> claims to have prepared sols of the carbonates of calcium, strontium, barium and magnesium by conducting carbon dioxide into solutions of the respective metallic oxides in methyl alcohol. Buzágh<sup>2</sup> found, however, that the sols formed in this way were the dimethyl alkaline earth carbonates and not the normal carbonates of the metals. To obtain sols of normal carbonates, carbon dioxide was passed into a suspension of the metallic hydroxides in methyl alcohol, filtering off any residue that remained.

While the stability of the nickel hydrosol is doubtless due to the presence of some undecomposed nickel carbonyl and that of metallic carbonates to dissolved hydroxide, lyophobic sols with a marked charge have been formed where the presence of an electrolyte is improbable. Thus Siedentopf<sup>3</sup> exposed a concentrated solution of yellow phosphorus in carbon disulfide to visible light radiation in the quartz chamber of the cardioid ultramicroscope and observed the formation of a sol consisting of particles of the insoluble red modification of phosphorus which appeared to have a weak negative charge. Wiegand<sup>4</sup> prepared colloidal sulfur in an analogous manner. The soluble crystalline sulfur dissolved in carbon disulfide and in carbon tetrachloride was converted into a sol of the insoluble amorphous element by light radiation. Cataphoresis experiments indicated a marked negative charge on the particles. Amann<sup>5</sup> also obtained sulfur sols by this method in carbon disulfide, benzene, amyl alcohol and turpentine.<sup>6</sup>

2. *Electrolyte reacts with solvent.* But three organosols have been described in which the concentration of agglomerating agent is kept low by interaction of the solvent with the electrolyte formed by double decomposition. All three were obtained in pyridine but it is altogether probable that other substituted amines as well as ketone compounds would serve equally well.

Naumann<sup>7</sup> obtained a pyridine sol of copper sulfide by the action of dry H<sub>2</sub>S on a dilute solution of copper chloride in pyridine. The hydrochloric

<sup>1</sup> Neuberg and Neimann: *Biochem. Z.*, 1, 166 (1906); Neuberg and Rewald: *Kolloid-Z.*, 2, 321 (1908); Neuberg: *Sitzungber. Akad. Wiss. Berlin*, 1907, 820.

<sup>2</sup> Buzágh: *Kolloid-Z.*, 38, 222; 39, 218 (1926).

<sup>3</sup> *Ber.*, 43, 692 (1910).

<sup>4</sup> *Z. physik. Chem.*, 77, 423 (1911).

<sup>5</sup> *Schweiz. Wochenschr.*, 47, 439.

<sup>6</sup> Cf., also, Biltz: *Kolloid-Z.*, 12, 296 (1913).

<sup>7</sup> *Ber.*, 37, 4612 (1904).

acid, formed simultaneously, reacts with the pyridine forming the hydrochloride,  $C_5H_5N \cdot HCl$ . In a similar way Pieroni and Tonnioli<sup>1</sup> made sols of silver and mercuric sulfide by treating pyridine solutions of silver nitrate and mercuric acetate, respectively, with dry  $H_2S$ . In the next section it will be shown that a fairly stable mercuric sulfide sol in acetone can be formed by adding  $H_2S$  to an acetone solution of mercuric chloride.

3. *Electrolyte non-ionized.* Charitschkov<sup>2</sup> was apparently the first to use a procedure for the preparation by metathesis of a lyophobic organosol which owed its success to the formation of an unionized substance. Solutions of metallic naphthenates in various hydrocarbon solvents were treated with hydrogen chloride or carbon dioxide. Under these conditions the metallic chlorides and carbonates were obtained in the colloidal state, the naphthenic acid formed simultaneously being unionized or very slightly ionized and so being without coagulating action. Because of the slight ionization of the acid there may be some question as to whether the sols owe their stability to adsorbed ions. However, the fact that an excess of naphthenate is necessary for preparing sols from the alkali metal salts but not from the less active heavy metal salts, indicates that the naphthenate ion acts as a stabilizing agent. Colloidal sodium and potassium chlorides and carbonates and cupric, mercuric, and ferrous chlorides in benzene, toluene, and hexane have been described. Sodium chloride, bromide, and iodide sols formed by the interaction of sodium malonic ester and chloroacetic ester in dry benzene<sup>3</sup> owe their stability to strong adsorption of one or more of the organic reagents and so must be classed as lyophilic sols.

A better illustration we owe to Bikerman<sup>4</sup>. Arsenic trioxide was dissolved in nitrobenzene and dry  $H_2S$  bubbled through the solution until the arsenic was converted completely into the sulfide sol. The excess  $H_2S$  and the unionized  $HCl$  were removed with a current of air. The sols were yellow-red in color, and varied in concentration from 5 to 30 millimols per liter. The particles were negatively charged and remained dispersed indefinitely unless coagulated by the addition of electrolytes. A similar sulfide sol was obtained in acetoacetic ester but the preparation was less satisfactory since the hydrogen sulfide reacted with the solvent to some extent, probably giving mercaptans. These imparted a repulsive odor to the sols although they had no apparent deleterious effect on the stability.

4. *Electrolyte is insoluble.* As this principle is applied here for the first time in the preparation of organosols (see experimental part) and has not been used for the preparation of hydrosols, the general method will be outlined in a little more detail. A compound  $AB$  is taken which is soluble in the organic medium and sufficiently ionized to undergo double decomposition with a second compound  $CD$  possessing similar properties. By a suitable

<sup>1</sup> Gazz., 43, I, 198 (1913).

<sup>2</sup> J. Russ. Phys. Chem. Soc., 52, 91 (1920); J. Chem. Soc., 122, (2) 827 (1922).

<sup>3</sup> Paal and Kuhn: Ber., 39, 2859 (1906); 41, 51 (1908).

<sup>4</sup> Z. physik. Chem., 115, 261 (1925).

choice of reagents, the metathetical reaction products may be obtained such that AD is an insoluble unionized substance which shows strong selective adsorption for the ions present and BC is a substance sufficiently insoluble to keep the ionic concentration low. Under these conditions AD will remain dispersed while BC comes down as a precipitate. This method has been found to be quite satisfactory for forming organosols of the metallic oxides. Since it is quite general, it would doubtless serve for the preparation of colloidal salts such as the sulfides and ferrocyanides.

### Dispersion Methods

Dispersion methods that have been employed in preparing organosols involve (a) the addition of a peptizing agent (b) the removal of an agglomerating agent and (c) electrical dispersion.

*Addition of peptizing agent.* Bikerman<sup>1</sup> prepared a sol of arsenic trisulfide in aniline by treating a solution of arsenic triiodide in aniline with hydrogen sulfide. A precipitate was first formed in both cold and hot solutions but this went into colloidal solution on continued passing of the gas through the suspension. The sol was blood red in color and was coagulated by boiling but was redispersed by hydrogen sulfide, showing that the primary particles did not coalesce in the precipitation process. Arsenic trichloride could not be substituted for the triiodide as it formed an insoluble complex with the aniline and gave a compact non-peptizable precipitate of the trisulfide.

By a similar procedure Naumann<sup>2</sup> prepared a reddish-yellow sol of cadmium bromide with H<sub>2</sub>S followed by adding an excess of the gas. Some thioacetone was formed in the process and this may have a stabilizing action.

*Removal of agglomerating agents.* Peptization resulting from removal of agglomerating agent has been used repeatedly in the preparation of hydrosols but we have found no reference to the use of this method in preparing organosols. That it may be employed to advantage is demonstrated by the preparation of a number of ferrocyanide organosols to be described in a later section.

*Electrical Dispersion.* The most widely known and extensively investigated organosols are those prepared by the disintegration of metallic electrodes in an electric arc. This method was introduced by Bredig<sup>3</sup> and developed by Svedberg<sup>4</sup>. While the metal in mass is dispersed as a sol, Svedberg<sup>5</sup> points out that the mechanism by which the sol is formed is condensation and not dispersion; the heat of the arc volatilizes some of the metal from the electrode which, on cooling, condenses from the atomic state.

<sup>1</sup> Z. physik. Chem., 115, 261 (1925).

<sup>2</sup> Ber., 37, 4328 (1904).

<sup>3</sup> Z. angew. Chem., 951 (1898); Z. physik. Chem., 32, 127 (1900).

<sup>4</sup> Svedberg: Ber., 39, 1705 (1906); Nova Acta, Upsala (4), 2, No. 1, 14 (1907); Herstellung kolloider Lösungen, 423 (1909); Meddel. Nobelinst., Stockholm, 5, No. 10, 3 (1919); Börjeson and Svedberg: Kolloid-Z., 25, 154 (1919); Nordlund: Kolloid-Z., 26, 121 (1919); Börjeson: Dissertation, Upsala (1921).

<sup>5</sup> "Formation of Colloids", (1921).



As originally used, a direct current was caused to arc between the metal electrode immersed in cooled water. Degan<sup>1</sup> and Burton<sup>2</sup> attempted to use organic solvents without success partly because the arc decomposed the solvent and partly because the metal vapor was cooled so rapidly that coarse particles were formed. The problem was finally solved by Svedberg. His first improvement in the original Bredig method was to enclose the arc in a quartz tube containing a small hole just above the arc. The enclosed arc was immersed in the liquid which was prevented from coming in contact with it by a stream of indifferent gas which was led into the quartz tube and bubbled into the liquid through the small hole. The metallic vapor was not carried along by the escaping gas very well so that a magnetic field was applied to assist in removing the particles from the tube. The arrangement avoided decomposition of the solvent and the degree of dispersion was quite high. The method was further improved by the use of an alternating current arc. The best results were obtained when the self inductance, resistance and arc length were small, the capacity large, and the temperature of the dispersion medium low.

Svedberg obtained all the available metals dispersed in methyl, ethyl, propyl, butyl, and amyl alcohols; ethyl ether; acetone; and ethyl and amyl acetates. Börjeson<sup>3</sup> found that the size of the particles was independent of the capacity, self inductance, and intensity of the current but did depend on the viscosity of the dispersion medium. Hence, larger particles were obtained in the same liquid at lower temperatures of formation. Another curious fact is that under the same conditions all metals yielded particles of approximately the same size.

### Experimental

#### Mercuric Sulfide Organosols

*In methyl alcohol.* The marked tendency of mercuric sulfide to exist in the colloidal state and the exceptional solubility of the mercuric salts in organic liquids led to its selection for a study of the most favorable conditions for the formation of organosols.

At the outset a dispersion method was attempted. Purified mercuric chloride was dissolved in methyl alcohol to a concentration of 70 grams per liter and dry hydrogen sulfide was bubbled through the solution giving a flocculent yellowish precipitate which set to a thick jelly of the double salt,  $\text{HgCl}_2 \cdot 2\text{HgS}$ .<sup>4</sup> Continued passing of the gas through the viscous mass resulted in the formation of a granular precipitate of black  $\text{HgS}$  which could not be peptized by washing out the hydrochloric acid with the aid of the centrifuge, suspending in methyl alcohol, and passing in  $\text{H}_2\text{S}$ . Similar results were obtained by starting with a solution containing 10 grams of mercuric chloride per liter. Finally, the methyl alcohol was first saturated with hydrogen

<sup>1</sup> Dissertation, Greifswald (1903).

<sup>2</sup> Phil. Mag., (6) 11, 425 (1906).

<sup>3</sup> Loc. cit.

<sup>4</sup> Jolibois and Bouvier: Compt. rend., 170, 1497 (1920).

sulfide, and while the gas was bubbled in continuously, mercuric chloride was added equivalent to 5 grams per liter. Under these conditions the white intermediate compound was converted rapidly into a black sulfide which was much less granular and settled more slowly than that previously obtained. After washing out the HCl with pure alcohol, suspending the mass in the organic liquid, and treating with hydrogen sulfide, a fairly stable brown-gray sol was formed which precipitated but slightly in four days. The sol was decanted from the precipitated sulfide, tightly stoppered, and kept for 17 days without further change. For the purpose of comparison, the mercuric

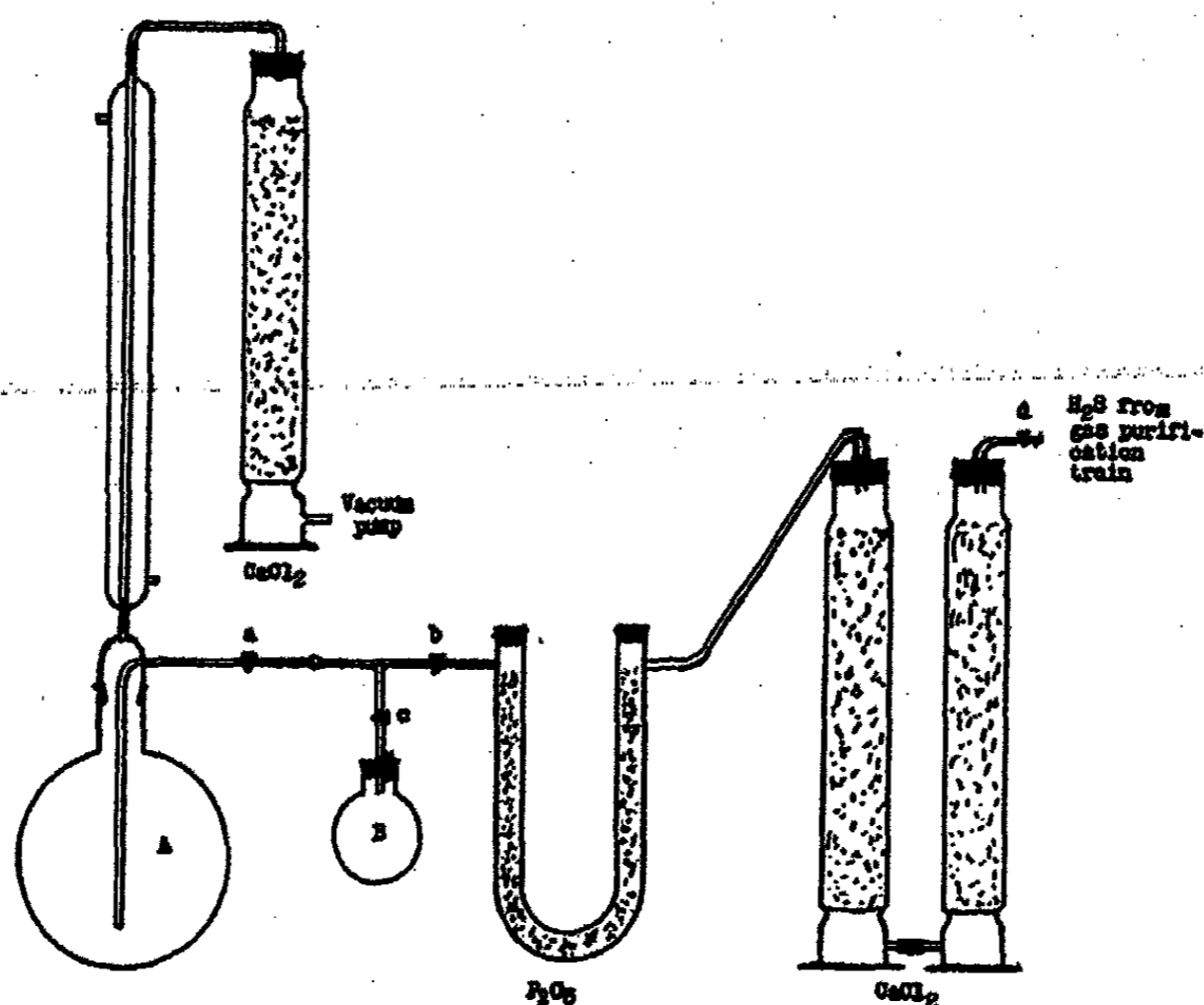

FIG. 1

salt solutions subsequently used were made up so that the initial concentration of mercuric sulfide was approximately the same as that used in preparing the above sol.

Granular non-peptizable precipitates of mercuric sulfide were formed from methyl alcohol solutions of mercuric sulfate and mercuric nitrate. Mercuric bichromate was found to be but slightly soluble in methyl alcohol. On passing hydrogen sulfide through a suspension of the salt, a flocculent coffee-brown precipitate of the sulfide was obtained which was not peptized by hydrogen sulfide after washing and suspending in the alcohol. With mercuric acetate a sol was formed directly, the ionization of the acetic acid being too small to cause agglomeration. This is therefore a condensation process in which the second product of the metathetical reaction is ionized so slightly that precipitation is prevented. The sol containing all the acetic acid was stable indefinitely. The color by reflected light was a distinct blue-black which became brown at high dilution. There was no trace of the gray tint that

characterizes the less stable sols. Incidentally, the color is a reliable criterion of the stability of the sols since precipitation is always preceded by a gradual transition in color through various shades of gray to a dull slate.

The above observations show that the sols formed by dispersion of the purified mercuric sulfide are relatively instable while the stable sol formed from mercuric acetate is impure. In an attempt to get a sol of maximum stability which could be freed from practically all electrolytes, it was decided to start with mercuric cyanide and devise a method for removing the hydrocyanic acid. Lottermoser<sup>1</sup> claims that the acid cannot be removed by washing the sol formed from mercuric cyanide with hydrogen sulfide or carbon dioxide since the molecular solubility of the former is greater than of the latter. Since the sol is sensitive to heat, the purification of the sol was accomplished by distillation under reduced pressure in the apparatus shown in Fig. 1. Five

TABLE III

Sample	Time (hours)	Pressure (mm)	Temperature °C	Cyanide test	Concn. of solution grams per liter
1	2	183 - 185	35 - 37	trace	5.0
2	3	185 - 200	37 - 40	very slight	5.0
Cooled and allowed to stand 13 hours					
3	3	200 - 225	39 - 41	none	4.7
4	2	400 - 420	50 - 52	none	
5	3	782	68	none	1.35

grams of pure dry mercuric cyanide were dissolved in 1000 cc of Baker's special C.P. methanol. The solution was poured into flask A with as little exposure to air as possible. Air and other impurities were removed completely from the gas purification train by washing out with hydrogen sulfide through B for one hour. After closing c the solution in the flask was saturated with hydrogen sulfide at 25°. When the reaction was complete with the formation of a deep black sol of mercuric sulfide, a water bath was placed under the containing flask and suction applied to the system, the pressure being regulated by suitable adjustment of stopcocks a and d. The sol was then refluxed to drive out the HCN. By closing stopcocks d and b and opening a and c, to create a slight vacuum in B, samples for analysis were withdrawn at intervals without exposure to the air. The test for cyanide was made by the method of Lauder and Walden.<sup>2</sup> Aliquot parts of the sol were analysed for the sulfide content. The results of a series of observations are given in Table III. From these results it is quite clear that the sol is unstable above 40° in the absence of an excess of H<sub>2</sub>S. All the samples seemed to be unfavorably affected by the heat, the color becoming a decided gray after heating a short time. The sols were extremely sensitive, complete removal of the hydrogen sulfide causing coagulation. In general the preparations were relatively pure, but so unstable that they were not satisfactory.

<sup>1</sup> J. prakt. Chem., (2) 75, 293 (1907).

<sup>2</sup> Analyst, 36, 266 (1911).

*In acetone.* Pure dry acetone was next substituted for methyl alcohol as the dispersion medium. In marked contrast to the behavior in methyl alcohol, a solution of mercuric chloride in acetone gave a sol directly on treating with  $H_2S$ . The reason for this is that hydrochloric acid combines with acetone forming the slightly ionized acetone hydrochloride which has but little coagulating action as compared with hydrochloric acid. The sol was not very stable, however, showing marked coagulation in 2 days. A more stable sol was formed by starting with mercuric acetate. This does not dissolve in acetone but gives a fine yellow suspension which yields a fairly stable brown-gray sol on treating with hydrogen sulfide. The sol showed no precipitation in 3 days; but partial coagulation in 6 days, which was incomplete after 17 days.

In the next experiment a solution of mercuric cyanide in acetone was treated by the same procedure in the same apparatus employed for the preparation and purification of the methyl alcosol. The impure acetone sol was more stable than the methyl alcosol, but precipitated on removing hydrogen sulfide; and no cyanide was driven out by refluxing at  $40^\circ$  for 8 hours at a pressure of 358-360 mm. An addition product, acetocyanhydrin, was formed which is too stable to be decomposed under the conditions employed.

*In n-propyl alcohol.* Propyl alcohol proved to be a much more satisfactory dispersion medium than methyl or ethyl alcohol since it is not highly hygroscopic and consequently is easier to handle without introducing impurities. On adding hydrogen sulfide to a solution of mercuric chloride in the alcohol, mercuric sulfide was thrown down in a compact granular form. When this was washed to remove the hydrochloric acid, the yellow double salt,  $HgCl_2 \cdot 2HgS$  was obtained in a flocculent state. On suspending this precipitate in pure alcohol and adding  $H_2S$ , the black sulfide was again formed and could now be washed since the hydrochloric acid concentration was too low to form the double salt. Only a very unstable sol was formed by treating the suspension of the washed sulfide with excess hydrogen sulfide.

2.5 grams of mercuric cyanide were next dissolved in 500 cc of the propyl alcohol and treated with  $H_2S$  in the apparatus shown in Fig. 1, at a temperature of  $70^\circ$  and under a pressure of 757 mm. The color developed very slowly, indicating a low solubility of the gas under these conditions. After conducting the gas through the solution for 3 hours it was allowed to stand at room temperature 15 hours, at the end of which time the sulfide formed was completely precipitated. The reaction was incomplete and two repetitions of the above procedure at room temperature were necessary to convert all the cyanide into sulfide. The precipitated sulfide was only partly reprecipitated by excess  $H_2S$ , the resulting sol containing 0.324 gram  $HgS$  per liter after thorough washing to remove the excess  $H_2S$ .

Since in every case the stability of the sols is adversely affected by the heat required to remove the hydrocyanic acid, it is obvious that Lottermoser's method is very unsatisfactory. His statement that a volatile gas cannot be completely removed from solution by washing with another if the solubility

of the first exceeds that of the second seemed questionable, since it is known that ammonia can be removed from aqueous solution by bubbling air through it at room temperature for a long time. It occurred to us that Lottermoser failed to observe a purification of his sols from hydrocyanic acid by washing at room temperature with hydrogen sulfide or carbon dioxide because his sols were too concentrated and he did not wash long enough. This proved to be the case. The initial concentration of  $\text{Hg}(\text{CN})_2$  was therefore reduced to 1 gram per liter. 0.75 gram of salt was dissolved in 250 cc of propyl alcohol and this solution was poured slowly into 500 cc of alcohol saturated with hydrogen sulfide. A deep brown sol formed immediately and turned black rapidly. Pure dry hydrogen sulfide was bubbled slowly through the sol for 24 hours at room temperature to ensure complete reaction. A small sample withdrawn after 13 hours gave only a slight test for cyanide. Dry hydrogen was then passed through the solution for 40 hours after which no cyanide could be detected in the sol.

The preparation was quite satisfactory and could be preserved in a Pyrex flask for 6 months without coagulation. Later observations disclosed that the initial temperature of formation is a most important factor in preparing a pure stable sol. The best results are obtained by cooling both the salt and hydrogen sulfide solutions in ice water before mixing and bubbling hydrogen sulfide through the cold solution. Subsequent heating to  $35^\circ$  of a sol prepared in the cold causes little or no sensitization, provided the  $\text{H}_2\text{S}$  is not removed completely. Care must be taken not to wash out all the stabilizing electrolyte. Continuous bubbling of the hydrogen for 40 hours through 250 cc of the cold sol is sufficient.

#### Oxide Sols in N-Propyl Alcohol

A number of typical oxide sols in n-propyl alcohol were prepared, using the general method in which the reaction was so chosen that the electrolyte formed simultaneously with the oxide was insoluble in the solvent. N-propyl alcohol proved to be a suitable solvent for the purpose at hand. The hydrocarbon chain is sufficiently long so that most strong electrolytes are practically insoluble in it, thus holding the ion concentration below the critical coagulation value. At the same time, the molecule is small enough that the hydroxyl group has a large influence, giving it modified properties of an ionizing solvent.

*Ferric oxide alcocol.* Anhydrous ferric chloride and potassium oxide were found to be sufficiently soluble in propyl alcohol to serve for the preparation of the ferric oxide sol. The anhydrous chloride was prepared in the following way. Holes were blown in the bottom of two 500 cc round-bottom pyrex flasks and the two were sealed together, the constriction being approximately 1.5 cm. in diameter. The apparatus was supported horizontally and the necks of the flasks were supplied with stoppers containing glass tubes through which gas could be conducted in and out. In one of the flasks was placed pure arsenic-free iron which was heated gently while dry chlorine gas was conducted over it until most of the metal was converted into chloride which condensed on the walls of the vessel. After cooling, the excess chlorine was

swept out with a current of dry carbon dioxide and the flask heated to volatilize the ferric chloride which was carried through the constriction in the stream of gas and condensed in the second flask. The latter was opened and a cork inserted in the constriction to keep out impurities from the first flask, after which a small amount of dry propyl alcohol was poured in rapidly. Solution was rapid and the liquid was drained into a pyrex flask and diluted to approximately 100 cc. Analysis of the solution gravimetrically as AgCl and as  $\text{Fe}_2\text{O}_3$  showed it to contain, respectively, 0.00367 and 0.00380 gram  $\text{FeCl}_3$  per gram of solution.

Potassium oxide was formed by a greatly simplified modification of the method of Rengade.<sup>1</sup> A 20 cm pyrex tube was drawn out at a point about 5 cm from the top to a constriction about 1.5 to 2 mm in diameter. It was essential to keep the walls of the constriction thick. Metallic potassium cut under light petroleum was placed in the upper section of the tube. A cork stopper was sealed into the tube with deKhotinsky cement after which the system was evacuated. When the pressure was below 5 mm of mercury the metal was melted and flowed into the lower portion of the tube. The capillary strained out any impurities and the clean bright metal solidified in the bottom of the container. Oxygen was then added very slowly keeping the pressure below 5 mm. When most of the free metal was oxidized as evidenced by the gradual transition of the gray solid solution of potassium in potassium oxide to the white crystalline  $\text{K}_2\text{O}$ , the oxygen supply was cut off and the lower portion of the tube enclosed in a round bottom flask which served as an air oven. The excess metal was distilled from the oxide by maintaining the air in the flask for 2 to 4 hours at a temperature of 250-300°, below which the oxide is not volatile. At the end of the distillation process the capillary was sealed off. Large amounts of potassium oxide cannot be added directly to propyl alcohol as the action is too violent. The sealed tube was therefore broken in a heavy flask filled with dry air and the oxide added to ice-cold propyl alcohol in small amounts at a time, avoiding contact with air as much as possible. The solution was analyzed by titration against standard hydrochloric acid.

Weighed equivalent amounts of the ferric chloride and potassium oxide solutions were mixed rapidly, the oxide being added to the chloride. The cloudy red-brown liquid was then centrifuged at 800 r.p.m. for 20 minutes. This threw down the white precipitate of potassium chloride from which a clear red sol resembling the Graham hydrosol was decanted off. The concentration of the sol was 1.3 grams  $\text{Fe}_2\text{O}_3$  per liter.

The organosol proved to be perfectly stable as long as moisture was carefully excluded, but coagulated rapidly to a gelatinous precipitate on adding a trace of water. This was attributed to the increased ionization of dissolved potassium chloride so that attempts were made to purify the sol by electro dialysis. This proved to be unsatisfactory since the particles diffused through both parchment and cellophane membranes and the current was very low

<sup>1</sup> Ann. Chim. Phys., (8) 11, 348 (1907).

THE FORMATION OF LYOPHOBIC ORGANOSOLS



(0.2 milliampere under a potential difference of 250 volts) on account of the high resistance. The extremely fine state of subdivision of the particles was rather surprising since they were formed in the presence of an appreciable amount of KCl, the solubility of the latter in propyl alcohol being 0.050 gram per liter.<sup>1</sup>

Both positive and negative sols are easily obtained, since the sol is stable in the presence of an excess of either potassium oxide or ferric chloride. Lithium chloride salts out the less soluble potassium chloride but produces no noticeable coagulation of the ferric oxide. Potassium oxide in high concentrations produces partial coagulation while sulfuric acid causes complete coagulation; but, in general, the sol is not readily precipitated by electrolytes.

A methyl alcisol of ferric oxide was prepared by Mr. LaTour, by mixing  $\text{Ba}(\text{OH})_2$  with either  $\text{FeCl}_3$  or  $\text{Fe}_2(\text{SO}_4)_3$  solutions. On account of the lesser precipitating action of  $\text{BaCl}_2$ , a clearer, more stable sol was obtained by starting with ferric chloride solution; but unless great care is taken to obtain absolutely anhydrous alcohol, the  $\text{BaCl}_2$  is very incompletely precipitated. The sulfate gave a cloudy sol which was, however, perfectly stable.

*Manganic oxide alcisol.* Since anhydrous  $\text{MnCl}_2$  was found to be soluble in alcohols, the pink crystals of the tetrahydrate were dehydrated in an atmosphere of HCl and kept in a vacuum desiccator. 0.0434 gram of this salt was weighed in a closed vessel and dissolved in 15 cc of propyl alcohol to which was added a like amount of a propyl alcohol solution of potassium oxide containing the theoretical amount of base. Since precautions were not taken to exclude oxygen, a dark-brown sol was formed immediately. The oxide was probably manganic oxide or a mixture of manganic oxide and the white manganous oxide. The initial formation of the latter may have been overlooked since the finely divided potassium chloride which precipitated gave the mixture a grayish tinge. The sol was centrifuged at 1000 r.p.m. for 30 minutes and the glossy dark brown sol decanted from the precipitated chloride which was subsequently weighed and found to be 0.0474 gram. If all had precipitated, the weight would have been 0.0514 gram so that 0.0040 gram in 30 cc or 0.1332 gram per liter remained in solution.

The sol was perfectly stable in the original medium but precipitated when diluted with ether or water in all proportions, even a trace causing rapid coagulation. A sample containing 50% acetone was only partially precipitated in 3 days.

*Chromic oxide alcisol.* Anhydrous chromic chloride is too insoluble in propyl alcohol to be used in preparing a chromic oxide sol. However, if the green powder obtained by heating the hexahydrate in an atmosphere of HCl, is allowed to stand in the air a short time after weighing a small amount of moisture is absorbed and the salt then dissolves readily in the alcohol. The concentrations of chromic chloride and potassium oxide solutions were chosen so as to yield a sol containing 1 gram  $\text{Cr}_2\text{O}_3$  per liter. The base was added

<sup>1</sup> Turner and Bisset: J. Chem. Soc., 103, 1904 (1913).

to the salt solution in order to maintain an excess of  $\text{Cr}^{+++}$  ion. After throwing down the potassium chloride in the centrifuge, a clear green sol was obtained which was quite stable but became gradually turbid after standing one month. Adding 30% ether caused immediate turbidity and complete coagulation in one hour. 50% water caused no apparent change at first, but the sol became turbid after 10 hours and was completely coagulated in 12 hours. This was the only oxide organosol investigated which was not highly sensitive to small amounts of water.

#### Ferrocyanide Sols in Methyl Alcohol

Mr. Gill treated solutions of the chlorides or acetates of iron, copper, and zinc in methyl alcohol with a slight excess of a solution of hydroferrocyanic acid in the alcohol. The precipitates were then washed repeatedly by the aid of the centrifuge until they were peptized in the alcohol. The sols were quite stable and were clear both by transmitted and reflected light.

#### Summary

The results of this paper are as follows:

1. Organosols stabilized by the preferential adsorption of ions have been classified according to the process of formation employed to ensure their stability.
2. A survey has been given of the actual methods employed in the past for the preparation of lyophobic organosols and new and improved methods have been described for the preparation of a number of salt and oxide organosols.
3. Details are given for the preparation of mercuric sulfide organosols in methyl alcohol, acetone, and n-propyl alcohol; ferric oxide sol in methyl alcohol; ferric oxide, manganic oxide, and chromic oxide sols in n-propyl alcohol; and sols of copper ferrocyanide, zinc ferrocyanide and Prussian Blue in methyl alcohol.

*The Rice Institute,  
Houston, Texas.*



## STABILITY OF LYOPHOBIC ORGANOSOLS

BY HARRY B. WEISER AND GUILFORD L. MACK

Quantitative observations on the stability of organosols corresponding to the hydrosols are almost entirely lacking. Bikerman<sup>1</sup> measured the change in the  $\zeta$ -potential of arsenic trisulfide particles dispersed in acetoacetic ester and in nitrobenzene on adding ferric chloride, copper acetoacetate, and tetraethyl ammonium iodide; and Errera<sup>2</sup> observed the time required to coagulate alcosols of mercuric sulfide, cupric sulfide, and platinum by the addition of liquids of varying dielectric constant. But, for the most part, investigations on the stability of sols in the presence of organic liquids have been confined to a study of the effect of the organic liquid on the stability of hydrosols. In the experimental part of this paper are reported some observations on the effect of adding water and organic liquids to organosols stabilized by preferential adsorption of ions, together with similar observations on the effects of adding organic liquids to hydrosols. This is followed by a discussion of the several factors which may influence the stability of such colloidal systems.

As a measure of the stability of hydrosols toward electrolytes, it is usual to record the precipitation concentration of the electrolytes or to follow by cataphoresis experiments the change in the so-called  $\zeta$ -potential of particles on adding the electrolytes in question. Both of these procedures have been used.

### Preparations

*Solvents.* Observations previously reported<sup>3</sup> show that some organosols are very sensitive to slight traces of moisture. Accordingly special precautions were taken to prepare and preserve the organic liquids free from moisture. In all cases the purest material on the market was employed. The alcohols were all refluxed over lime for several hours and distilled, the first and last portions of the distillate being rejected. The middle portion was again refluxed over a small amount of lime for 8 to 10 hours before distilling and only that part of the distillate coming over within  $0.8^\circ$  on either side of the correct boiling point was used. A good grade of anaesthetic ether was first dried over calcium chloride for several days, decanted and distilled off phosphorus pentoxide, practically the whole amount coming over within  $0.5^\circ$  of  $35^\circ$ . The benzene was anhydrous and thiophene free and distilled within one degree of  $80.4^\circ$ . The water was double distilled in a block tin condenser.

<sup>1</sup> Z. physik. Chem., 115, 261 (1925).

<sup>2</sup> Kolloid-Z., 32, 240 (1923).

<sup>3</sup> Weiser and Mack: J. Phys. Chem., 34, 86 (1930).

*Sols.* Mercuric sulfide-methyl and propyl alcosols and ferric oxide-propyl alcosol were prepared as described in detail in the preceding paper.<sup>1</sup> Hydrosols of mercuric sulfide were prepared from mercuric cyanide (a) by a peptization method and (b) by a condensation method similar to that used in preparing the propyl alcosol.<sup>2</sup>

*Salt Solutions.* For studying the precipitation of organosols by electrolytes, solutions of lithium chloride and of calcium chloride in both methyl and propyl alcohol were prepared. No suitable salt with a divalent anion could be found. The salts were purified by recrystallizing C.P. grade chemicals and dehydrating in a current of dry hydrogen chloride to prevent the formation of oxychloride. Any trace of HCl was removed by heating in a carefully dried current of air.

The stock solutions were all made up by weighing both solute and solvent into cork stoppered Erlenmeyer flasks of about 50 cc capacity. The densities of each solvent for several temperatures were calculated from the equations given in International Critical Tables, Volume III, pages 27, 28. The values were plotted and smooth curves drawn from which the densities at any particular temperature could be read off. From these data the concentrations of the solutions in milliequivalents per liter were calculated. The lower concentrations were made up by the method of successive dilutions either by direct weighing or by volume, using accurately calibrated pipettes.

#### Precipitation Experiments

In all experiments six-inch Pyrex test-tubes previously steamed out and dried were employed. The stoppers were of cork purified by long boiling in distilled water and thoroughly dried. Five-cubic-centimeter portions of sol were first measured out, then sufficient alcohol to make the final volume 10 cc after the addition of the salt solution, and finally, the salt solution. By using care in adding the alcohol and salt solutions it was possible to avoid premature mixing. As already noted, special precautions were taken to exclude water at all times.

*Mercuric Sulfide Methyl Alcosol.* After determining the approximate concentration of electrolyte necessary for complete coagulation of the sol, a series of concentrations in this region were thoroughly mixed with samples of the sol and were allowed to stand quietly for 2 hours. The tubes were centrifuged for 10 minutes at 2000 r.p.m. By this procedure the effect of differences in concentration as low as  $1 \times 10^{-6}$  equivalents per liter were easily distinguishable. The critical concentration of  $\text{CaCl}_2$  was found to be 0.095 milliequivalent per liter and of  $\text{LiCl}$  4.7 milliequivalents per liter. These values are very much smaller than for similar salts on the mercuric sulfide hydrosol.<sup>3</sup>

<sup>1</sup> J. Phys. Chem., 34, 86 (1930).

<sup>2</sup> Freundlich and Schucht: Z. physik. Chem., 85, 643 (1913).

<sup>3</sup> Cf. Freundlich and Schucht: Z. physik. Chem., 85, 641 (1913).

*Mercuric Sulfide Propyl Alcosol.* Since methyl alcohol is so hydroscopic it was very difficult to avoid contamination with water. Accordingly, subsequent experiments were carried out with dispersions in propyl alcohol. The sol was prepared by peptizing the washed precipitated sulfide with hydrogen sulfide and an aged preparation formed by precipitating the sulfide from mercuric cyanide solution at 70°, peptizing the precipitate with excess H<sub>2</sub>S and washing very thoroughly with hydrogen.<sup>1</sup> The precipitation concentrations were determined for the pure sol and for the sol to which water was added. Considerable difficulty was encountered in finding a sensitive and reliable end-point. The sol was so much more polydisperse than the methyl alcosol that a satisfactory procedure for the latter was not suitable for the former. With lithium chloride as precipitating agent it was found that good results could be obtained by measuring the time at which a clear supernatant liquid just appeared on adding varying amounts of electrolyte, plotting the time against the concentration, and reading off the concentration which would just cause coagulation in two hours. This time was selected as it was about the shortest which fell on the flat of the curve so that a small difference in concentration would produce a large variation in time. The results of a series of observations are given in Table I and shown graphically in Fig. 1.

TABLE I  
Precipitation Concentrations of LiCl  
for HgS Propyl Alcosol, Pure and in the Presence of H<sub>2</sub>O

Percent water	Precipitation concentration milliequivalents per liter	Percent water	Precipitation concentration milliequivalents per liter
0	3.3	22	6.4
5	3.7	25	9.2
15	4.3		

In order to get a satisfactory measure of the precipitation value of CaCl<sub>2</sub> for the sol, pure and in the presence of water, it was found advisable to let the mixture of sol with electrolyte stand for 24 hours before centrifuging to determine whether coagulation was complete. The results are given in the second column of Table II and plotted in Fig. 1. It will be noted that the addition of water to the alcosol stabilizes it to a marked degree. (Cf. Table VIII).

A second set of observations were made on a portion of the same sol that had been aged for one month. During this time there was a gradual transformation from the finely divided solvated form to a granular crystalline form as evidenced by the change in color and the decrease in stability shown by the results given in the third column of Table II and in Fig. 1. The

<sup>1</sup> Cf. J. Phys. Chem., 34, 86 (1930).

somewhat higher precipitation value of the pure aged sol as compared with the fresh sol may be due to dilution of the former as a result of appreciable coagulation during standing.

The effect on the precipitation value of  $\text{CaCl}_2$  of adding a liquid of lower dielectric constant than propyl alcohol to the mercuric sulfide propyl alcosol is given in Table III and shown graphically in Fig. 2. It will be seen that the addition to the propyl alcosol of isoamyl alcohol, dielectric constant 17, decreases the stability toward electrolytes while the addition of water, dielectric constant 80, increases the stability toward electrolytes.

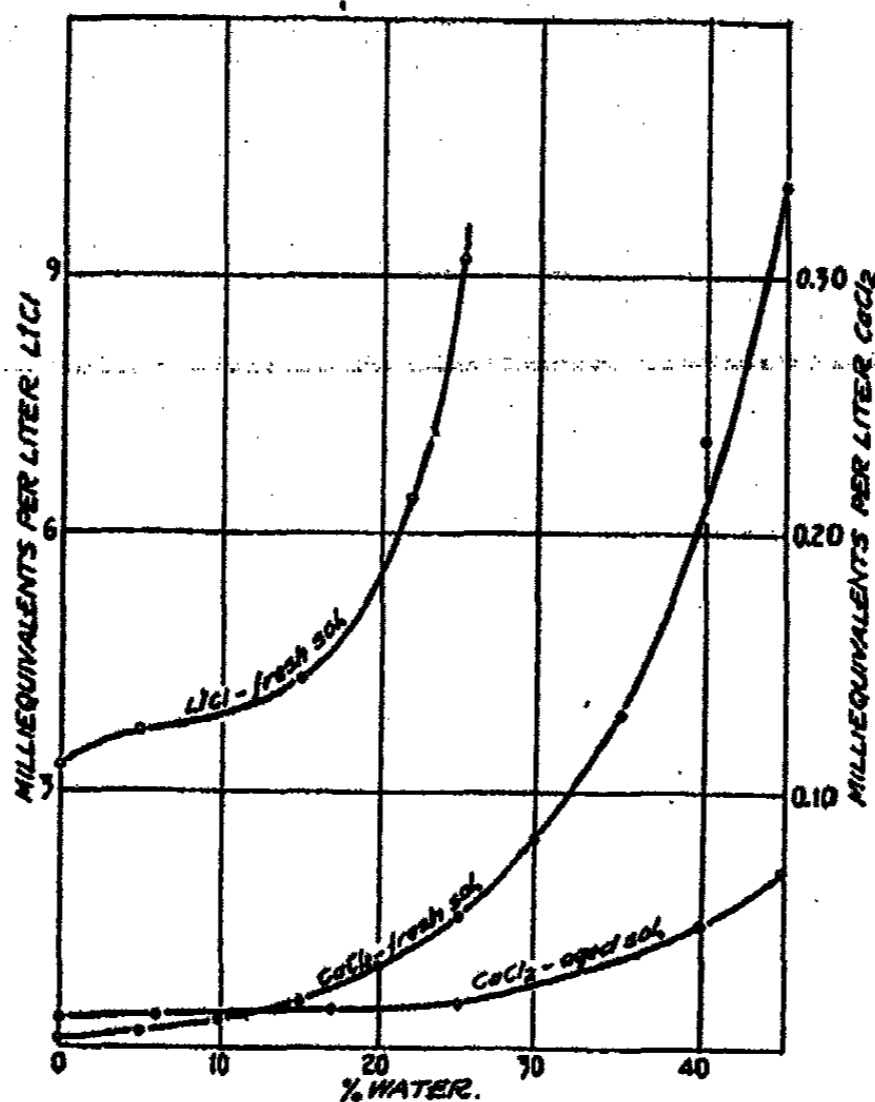

FIG. 1  
Precipitation Concentrations of Salts for HgS Propyl Alcosol-Water Mixtures.

TABLE II  
Precipitation Concentrations of  $\text{CaCl}_2$   
for a freshly Prepared and Aged Propyl Alcosol Pure and in the Presence  
of Water

Percent water	Precipitation concentration milliequivalents per liter		Percent water	Precipitation concentration milliequivalents per liter	
	Freshly prepared sol	Aged sol		Freshly prepared sol	Aged sol
0	0.0044	0.012	20	0.0310	—
5	0.0070	—	25	0.0520	0.0185
6	—	0.013	30	0.0820	—
10	0.0119	0.014	35	0.1300	0.0340
15	0.0190	—	40	0.2350	0.0487
17	—	0.0155	45	0.3350	0.0700

**TABLE III**  
**Precipitation Concentration of CaCl<sub>2</sub>**  
**for an Aged HgS Propyl Alcosol Pure and in the Presence of Isoamyl Alcohol**

Percent amyI alcohol	Precipitation concentration milliequivalents per liter	Percent amyI alcohol	Precipitation concentration milliequivalents per liter
0	0.0120	20	0.0098
5	0.0115	30	0.0080
10	0.0110	40	0.0065

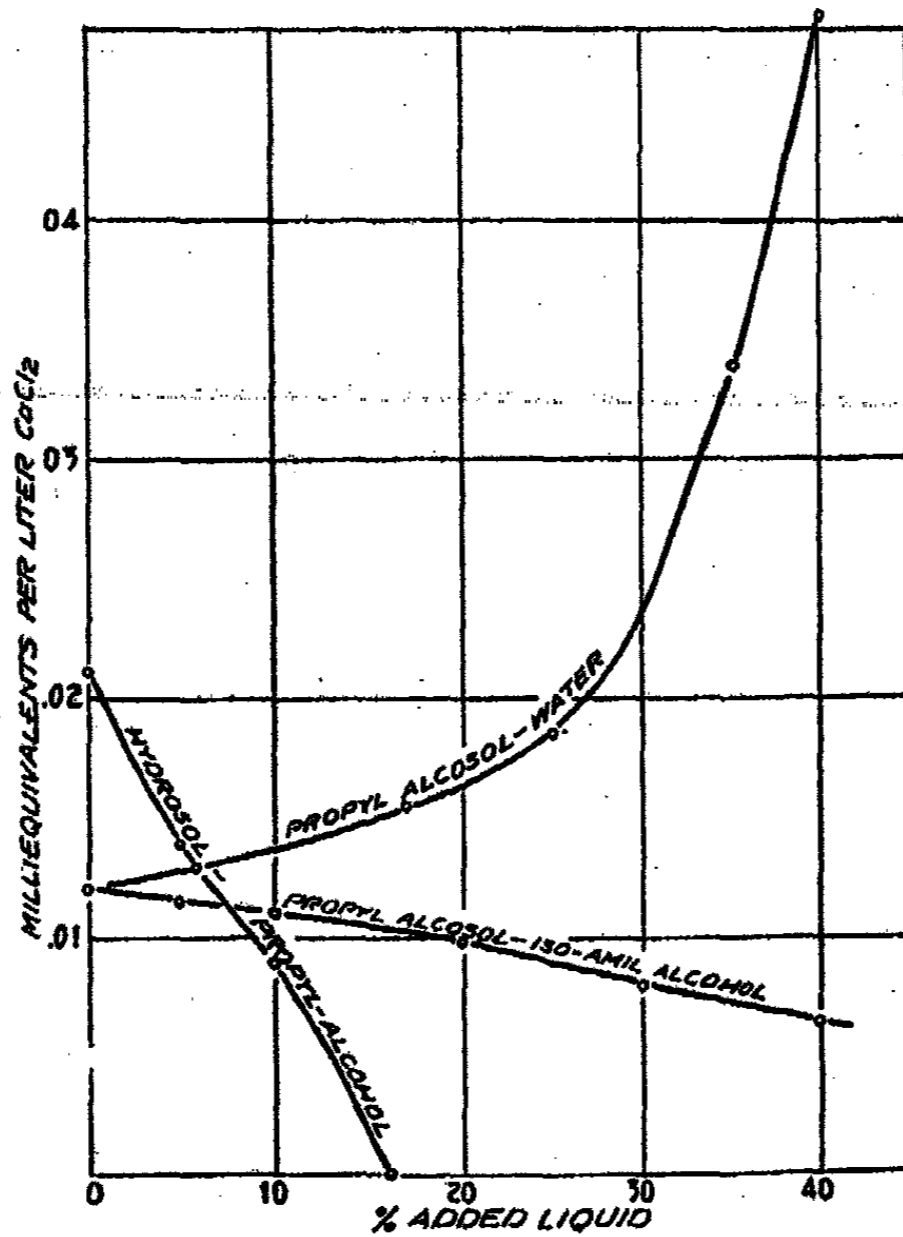

**FIG. 2**  
 Effect of Dielectric Constant of the Medium on the Stability of Sols toward CaCl<sub>2</sub>

**TABLE IV**  
**Precipitation Concentration of CaCl<sub>2</sub>**  
**on HgS Hydrosol Pure and in the Presence of Propyl Alcohol**

Percent by volume of propyl alcohol	Precipitation concentration milliequivalents per liter
0	0.0212
5	0.014
10	0.009
16	0.000
20	Precipitated, less than 4 hours
50	Precipitated, less than 3 hours

In the next experiments the effect on the precipitation concentration of  $\text{CaCl}_2$  of adding propyl alcohol to a mercuric sulfide hydrosol was determined. This is the reverse of the process of adding water to the alcosol and the results show just the opposite effect on the stability, as indicated by the data given in Table IV and shown in Fig. 2. The effects are qualitatively the same as those obtained by adding amyl alcohol to the mercuric sulfide propyl alcosol, the lowering of the dielectric constant in both cases producing a sensitization toward electrolytes. This is in line with Errera's observations.

#### Cataphoresis Experiments

There are three general methods for the measurement of the migration velocity of colloidal particles under the influence of a potential gradient: The velocity can be calculated from the change in concentration of the sol in a Hittorf transference cell; the movement of the interface between the sol and the upper layers of the dispersion medium in a U-tube can be measured; and the motion of the individual particles in a capillary tube may be observed directly in the ultramicroscope.

Svedberg and Anderson<sup>1</sup> have reviewed the voluminous literature on these three methods and have discussed critically the sources and magnitudes of the errors in each. Not much can be expected from Duclaux's transference method,<sup>2</sup> as the analysis seriously limits the accuracy and the electrolysis effects interfere with the change in concentration of the dispersed particles. The moving boundary method is very useful in certain cases, but it is subject to the same errors arising from conductance of the current by electrolytes, as in the former case. Since these errors are also present in the ultramicroscopic method, they may be enumerated and the conditions set down under which they will be at a minimum. First, the ions present in the solution will move much faster than the colloidal particles, and as the ionic concentration in the surrounding medium changes the particle charge will also change. This is the most serious error involved, and it can only be lessened by taking shorter intervals of observation. Second, the polarization at the electrodes introduces an error which may be eliminated by using a non-polarizing cell of the type introduced by Michaelis.<sup>3</sup> The percentage error due to this source can be reduced by raising the potential gradient, and it becomes negligible with several hundred volts. Third, the heat generated by the electric current will affect the velocity. This may be reduced, but not obviated by either reducing the voltage or the length of time through which it acts.

Thus there are two sets of conditions under which the combined effects due to the conduction of the current by electrolytes present in, or added to the sol will be at a minimum. The method developed by Kruyt makes use of macroscopic observation.<sup>4</sup> A low potential is used to reduce the Joule effect

<sup>1</sup> Kolloid-Z., 24, 156 (1919).

<sup>2</sup> J. Chim. phys., 7, 405 (1909).

<sup>3</sup> Biochem. Z., 16, 81 (1908).

<sup>4</sup> Kolloid-Z., 37, 358 (1925).

and the polarization potential is absolutely eliminated. But the current must be allowed to flow for a considerable time, so that the change in ion concentration is a very serious error. The alternate procedure was chosen by Svedberg and Anderson.<sup>1</sup> They used ultramicroscopic observation with a potential, thus obtaining small heat and polarization effects. The change in ion concentration is still appreciable, but is much less than in the former method because the observation time can be reduced to a small fraction of that necessary to produce a measurable migration in the U-tube. Kruyt objects to the very shallow cell and to the fact that gas bubbles may affect the results in a closed system. He devised a similar apparatus with an open cell, but was unable to obtain results with it which checked each other with an accuracy equal to that attained by Svedberg.

If these were the only considerations, the U-tube method would probably be slightly preferable. But there is another very large error involved in the non-uniform gradient. Even when the upper liquid consists of the ultrafiltrate from the sol, its conductivity is less. In organic dispersion media this error appears to be greatly magnified, as evidenced from the results of Mukherjee<sup>2</sup> and of Klosky.<sup>3</sup> Other difficulties are the need of special apparatus for the observation of colorless sols and the inability to maintain a sharp interface at the boundary, especially with large amounts of organic liquid present.

On the basis of these considerations, the method of direct measurement of the velocity of individual particles was adopted. For this purpose the apparatus designed by Mattson was employed. This consists essentially of an ordinary ultramicroscope with a specially constructed cell.<sup>4</sup>

In addition to the migration of the particles in a capillary tube, electro osmotic currents are set up by the external field of force. This motion of the liquid will affect the observed velocity of the particles. At the glass-liquid interface, the Helmholtz double layer is formed. In all the pure dispersion media employed, the glass is negatively charged but since small amounts of electrolytes easily change the sign of the charge, the adjacent liquid may move toward either electrode. Since the system is closed it follows that an amount of water equal to that transported along the walls must return in the opposite direction through the center of the tube. The observed velocity  $V'$  is therefore, given by the equation  $V' = V \pm v$  where  $V$  is the velocity of the liquid. Hence to obtain the true cataphoretic velocity, the motion of the liquid must be evaluated. This is accomplished indirectly by developing an equation expressing  $v$  in terms of the radius and the velocity at a fixed point. From theoretical considerations Smoluchowski<sup>5</sup> developed an equation for the motion of a liquid in a rectangular capillary. For a round capillary this expression takes the form:  $v = C(r^2 - a^2/2)^2$  where  $r$  is the distance from the center of the capillary,  $a$  the radius of the capillary and  $C$ , a constant deter-

<sup>1</sup> Kolloid-Z., 24, 156 (1919).

<sup>2</sup> J. Indian Chem. Soc., 5, 697 (1928).

<sup>3</sup> J. Phys. Chem., 33, 621 (1929).

<sup>4</sup> For description, see J. Phys. Chem., 32, 1532 (1928).

<sup>5</sup> Graetz: "Handbuch der Elektrizität und des Magnetismus," 2, 1382 (1921).

mined by the potential difference of the double layer. Now at  $r = 0$ ,  $v = v_0$  and  $v = 2v_0 (r^2/a^2 - 1/2)$ . Taking  $r$  at various values of  $a$  in this equation,  $v$  is obtained as a function of  $v_0$ . On putting these values of  $v_0$  in the expression  $V' = V \pm v$ , a series of equations is obtained which may be solved simultaneously with the elimination of  $v_0$ .  $V$  is thus obtained in any number of combinations of  $V'$  at two different depths of observations.

Preliminary observations on a positively charged Péan de St. Gilles ferric oxide hydrosol showed that readings taken at  $1/2$  and  $3/4$  of the radius gave the most consistent results. This compares favorably with the data of Svedberg and Anderson who found  $1/2 a$  and  $2/3 a$  to be the best for a rectangular tube. Similar observations on a negative mercuric sulfide sol in 50 percent propyl alcohol confirmed the observations that best results would be obtained by a combination of  $1/2 a$  with  $2/3 a$  or  $3/4 a$ . For this reason Mattson's method of taking a single reading at  $0.707 a$  was not used. However, the method was tested using a negative silver sol protected by sodium "protalbinat"; and the results agreed quite well with Mattson's for a quartz suspension.

Knowing the migration velocity of the particles the electrokinetic potential,  $\zeta$ , can be calculated from the Helmholtz-Perrin formula

$$\zeta = \frac{4\pi\eta v}{HD}$$

where  $v$  = the velocity of the particles,  $H$  = the potential gradient in volts per centimeter,  $D$  the dielectric constant of the pure liquid, and  $\eta$  the viscosity of the liquid.

In the experiments to be described, all liquids were mixed by volume. In every case an average of 10 readings of the cataphoretic speed was taken at each of the two depths. The dielectric constant of the mixtures was calculated on the assumption that it is a linear function of the percentage composition by weight. The viscosities were taken from International Critical Tables.

Moderate dilutions should not change the charge on the colloidal particle appreciably if the sol is highly pure. This is indicated by some observations with a ferric oxide sol containing 4 grams per liter prepared by the method of Sorum.<sup>1</sup> The value of the  $\zeta$ -potential in the original sol was 63.3 millivolts while in the sol diluted one-half it was 63.8 millivolts. This of course applies only to very pure sols since changing the concentration of electrolytes in contact with the particles will affect the charge on the particles. Thus Mukherjee found that the  $\zeta$ -potential of the particles of a ferric oxide hydrosol containing free ferric chloride was increased by dilution.

*Ferric Oxide Hydrosol + Propyl Alcohol.* The first observations were made of the effect of adding pure liquids on the  $\zeta$ -potential of the particles in sols containing only the stabilizing electrolyte in low concentration. The observations with a Péan de St. Gilles ferric oxide sol to which varying amounts of propyl alcohol and of acetone were added are given in Table V. While the stability of the positive hydrosol is decreased by the addition of the

<sup>1</sup> J. Am. Chem. Soc., 50, 1263 (1928).



TABLE V  
Effect on  $\zeta$ -potential of adding non-Electrolytes to Ferric Oxide Hydrosol

Non-electrolytes added percent by volume	Velocity of particles ( $\mu$ /sec)	Viscosity $\eta$	Dielectric constant	$\zeta$ -potential millivolts
0	7.60	0.00846	80	91.0
25% propyl alcohol	2.46	0.0184	68	75.9
50% propyl alcohol	1.48	0.0251	54	77.5
25% acetone	3.69	0.01161	66	70.8
50% acetone	2.98	0.01222	54	76.4

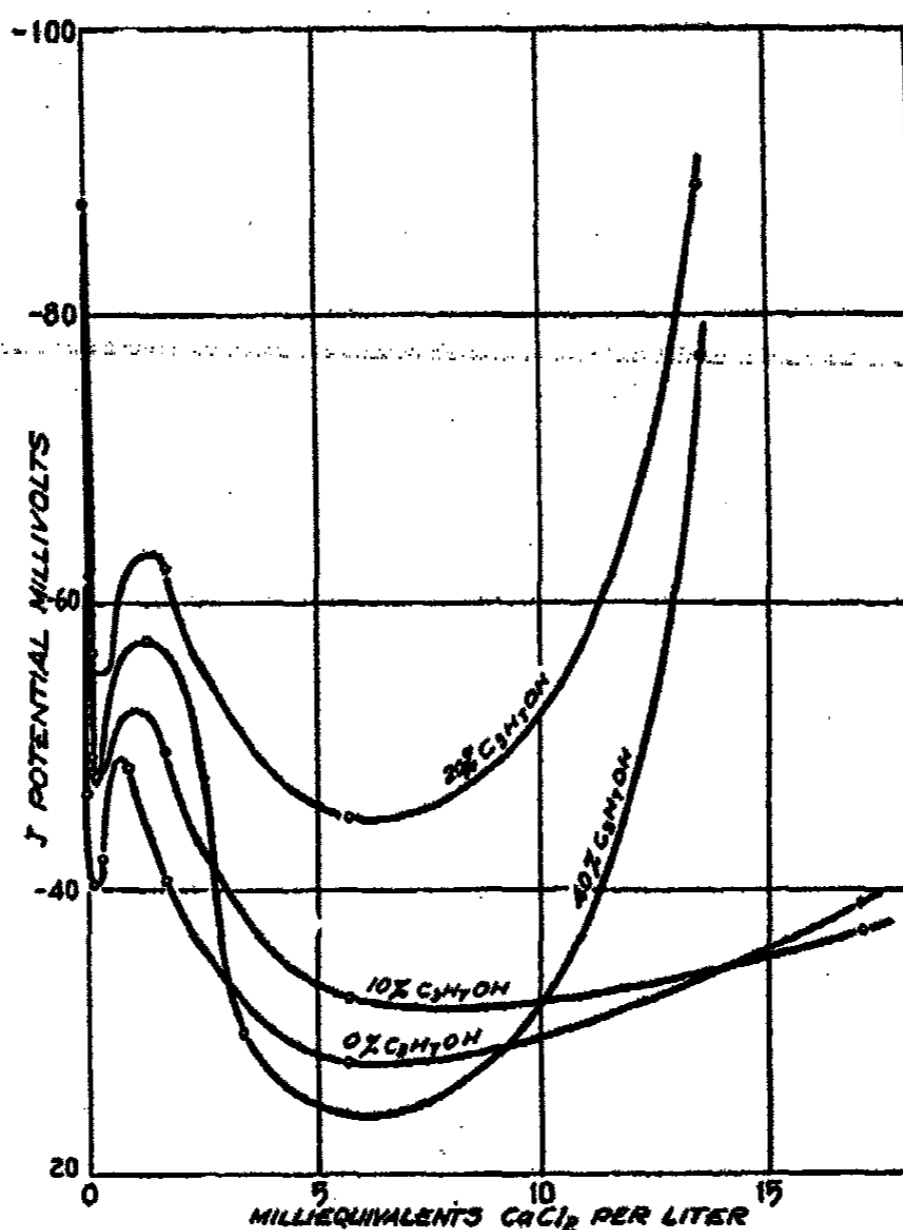

Fig. 3  
 $\zeta$ -potential of Particles on adding  $\text{CaCl}_2$  to HgS-Hydrosols-Propyl Alcohol Mixtures.

organic liquids, the decrease is not so marked as is usual with negative sols. Thus, in a previous experiment, 16% alcohol was found to precipitate completely a negative mercuric sulfide sol while the ferric oxide sol remained clear even when mixed with 50 percent of alcohol.

*Mercuric Sulfide Hydrosol + Propyl Alcohol and  $\text{CaCl}_2$ .* Measurements were next made of the charge on the particles of mercuric sulfide and the precipitating action of electrolytes when propyl alcohol was added to the hydrosol. For these experiments a sol was prepared according to the modified method of Lottermoser used in preparing the alcosol. In order to prevent the ageing of the sol as much as possible and to ensure its stability, the

hydrogen sulfide was not removed completely from the preparation. The sol, alcohol, and electrolyte were mixed uniformly and allowed to stand two hours after which the mixture was thoroughly shaken and a sample transferred to the cataphoresis cell for measurements. The effect of  $\text{CaCl}_2$  on the  $\zeta$ -potential of the particles in various mixtures is given in Table VI and shown graphically in Fig. 3.

TABLE VI

Effect on the  $\zeta$ -potential of adding  $\text{CaCl}_2$  to Mercuric Sulfide Hydrosol-Propyl Alcohol Mixtures

Calcium chloride milliequivalents per liter	Velocity of particles $\mu/\text{sec.}$	Viscosity $\eta$	$\zeta$ -potential millivolts	Coagulation time
<i>Pure water, dielectric constant 80.</i>				
0.000	3.68	0.00894	-46.5	
0.169	3.34	0.00891	-40.2	
0.338	3.56	0.00830	-41.8	
0.930	4.01	0.00851	-48.2	
1.691	3.37	0.00851	-40.6	
5.672	2.305	0.00851	-27.7	Precipitated, 1 hour
16.908	3.255	0.00851	-39.2	Precipitated, 2 hours
<i>10% alcohol, dielectric constant 75.3.</i>				
0.000	3.685	0.0120	-66.4	
0.169	2.73	0.0120	-49.3	
1.691	2.74	0.0120	-49.5	
5.672	1.796	0.0120	-32.4	
16.908	2.06	0.0120	-37.2	
<i>20% alcohol, dielectric constant 70.3</i>				
0.000	2.66	0.0161	-68.8	
0.169	2.185	0.0161	-56.5	
1.691	2.40	0.0161	-62.1	
5.672	1.738	0.0161	-45.0	
13.52	3.47	0.0161	-88.8	
<i>40% alcohol, dielectric constant 59.9.</i>				
0.000	2.01	0.0232	-87.6	
0.169	1.244	0.0232	-54.6	
1.352	1.302	0.0232	-57.2	Precipitated, 2 hours
3.382	0.682	0.0231	-29.9	Precipitated, 1 hour
13.52	1.76	0.0232	-77.2	Precipitated, 1:45 hours

Similar observations with  $\text{LiCl}$  are recorded in Table VII and Fig. 4. In the last column of the table, the extent of coagulation of the sols after a given time is noted. From the data in Tables VI and VII is plotted also the effect of

varying amounts of propyl alcohol on the  $\zeta$ -potential in the presence of constant amounts of salt, Fig. 5.

Considering the results with  $\text{CaCl}_2$ , it will be seen that very low concentrations at first cause a marked drop in the  $\zeta$ -potential without coagulation. This is followed by a relatively sharp rise at somewhat higher concentrations and then by a gradual decrease followed by coagulation with further additions of electrolyte and, finally, by a gradual rise. With  $\text{LiCl}$ , the  $\zeta$ -potential

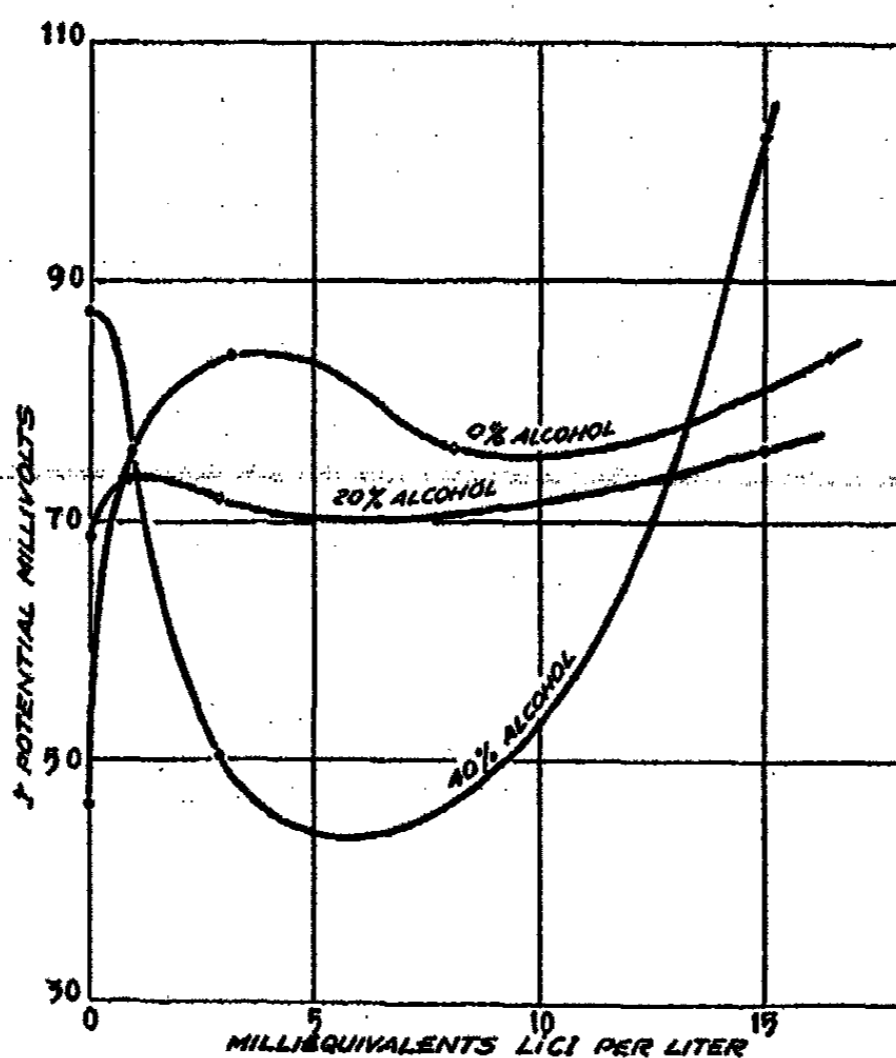

FIG. 4

$\zeta$ -potential of Particles on adding  $\text{LiCl}$  to  $\text{HgS}$ -Hydrosol-Propyl Alcohol Mixtures.

of the particles of pure hydrosol shows at first a very marked rise followed by a slight drop with higher concentrations and then a slight rise. In the presence of 20 percent propyl alcohol the initial rise in  $\zeta$ -potential on adding  $\text{LiCl}$  is slight while in the presence of 40 percent alcohol, the charge drops off sharply until 6 milliequivalents per liter of salt are added, above which it starts to rise, finally attaining a value considerably higher than that of the original sol to which no electrolyte was added. The gradual decrease in cataphoretic velocity of particles followed by a gradual increase on further additions of electrolyte has been observed by Mukherjee<sup>1</sup> with arsenious sulfide sol to which was added ethyl alcohol and potassium chloride and by Klosky<sup>2</sup> with silver sol to which was added alcohol and nitrates. In this connection Walden<sup>3</sup> points out that the addition of salts to pure liquids usually causes a

<sup>1</sup> Mukherjee, Rao Choudhury and Rao: *J. Indian Chem. Soc.*, 5, 707 (1928).

<sup>2</sup> *J. Phys. Chem.*, 33, 621 (1929).

<sup>3</sup> Walden, Ulich, and Werner: *Z. physik. Chem.*, 116, 261 (1925).

TABLE VII  
Effect on the  $\zeta$ -potential of adding LiCl to Mercuric Sulfide Hydrosol-Propyl Alcohol Mixtures

Lithium chloride milliequivalents per liter	Velocity of particles $\mu$ /sec.	Viscosity $\eta$	$\zeta$ -potential millivolts	Coagulation time
<i>Pure water, dielectric constant 80</i>				
0.000	3.68	0.00894	-46.5	
0.986	6.48	0.00830	-76.0	clear 24 hours
3.285	7.15	0.00830	-83.8	clear 7 hours, pptd. 30 hours
8.21	6.01	0.00830	-76.4	clear 24 hours
16.43	7.15	0.00830	-83.9	clear 7 hours, pptd. 30 hours
32.85	7.2	0.00830	-85	clear 7 hours, pptd. 24 hours
<i>20% alcohol, dielectric constant 70.3</i>				
0.000	2.66	0.0161	-68.8	
0.901	2.89	0.0159	-73.5	clear 24 hours
3.004	2.80	0.0159	-71.8	clear 48 hours
15.02	2.97	0.0159	-76.2	precipitated 24 hours
<i>40% alcohol, dielectric constant 59.9</i>				
0.000	2.01	0.0231	-87.6	
3.004	1.161	0.0231	-50.7	precipitated 2 hours
15.02	2.355	0.0231	-102.7	clear 17 hours, pptd. 48 hours

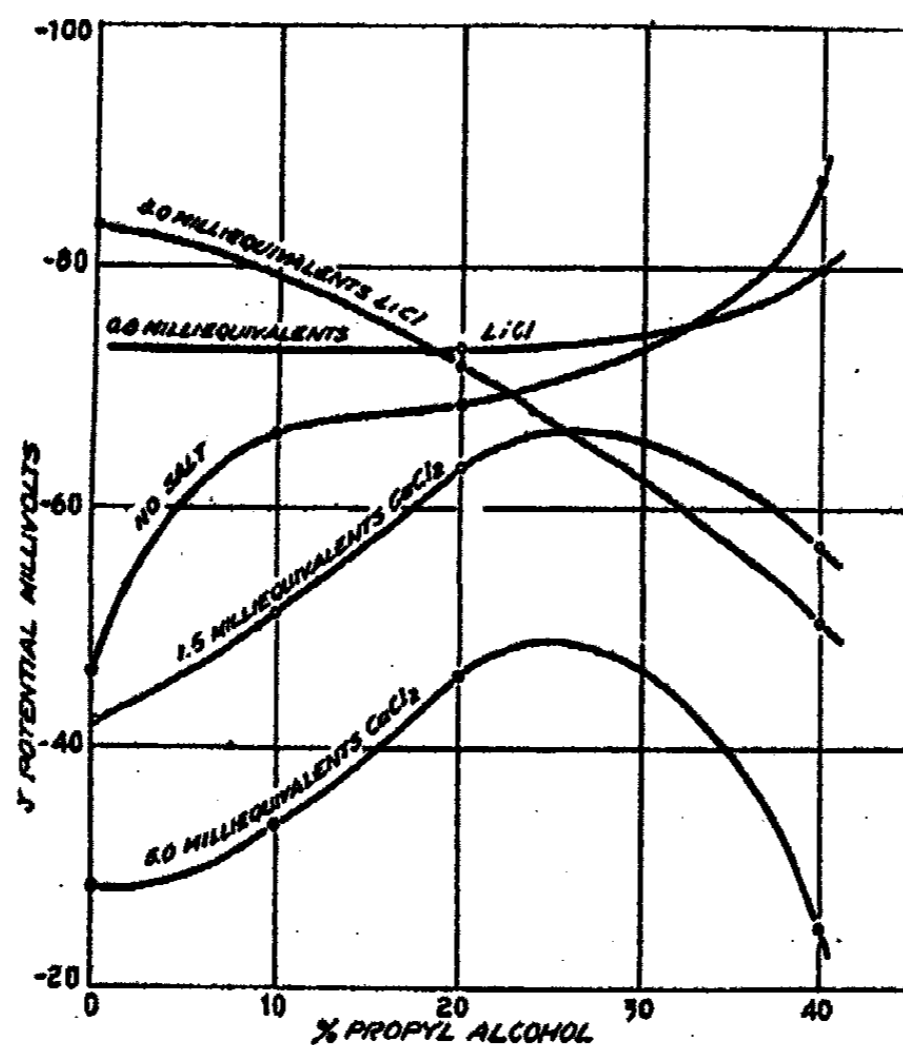

FIG. 5

$\zeta$ -potential of Particles in HgS Hydrosol-Propyl Alcohol Mixtures in the Presence of Constant Amounts of Salts.

lowering of the dielectric constant which passes through a minimum with increasing concentration and then increases to a value higher than that for the pure solvent. It is to this change in dielectric constant that Kruyt and van der Willigen<sup>1</sup> attributed the coagulation of arsenic trisulfide hydrosol by electrolytes such as KCl and  $K_4Fe(CN)_6$  which they found to increase the cataphoretic velocity of arsenic trisulfide particles<sup>2</sup> as we found LiCl to increase the cataphoretic velocity of HgS particles (Figs. 4 and 5). This point of view was definitely contradicted by Mukherjee.<sup>3</sup> "In the case of 10 percent methyl alcohol and varying concentration of potassium chloride, the cataphoretic speed increases from a minimum of about 39 to about 56, i.e., by about 43 percent. The dielectric constant of the mixture in the presence of 0.04 N KCl must be supposed to be about 43 percent greater than that in the absence of the electrolyte in order to bring down the potential to its original value and if we assume that coagulation takes place at a lower potential (the critical potential) then the increase in the dielectric constant must be supposed to be much greater. It is most unlikely that the dielectric constant changes to such an extent and we conclude that there is no definite critical potential characteristic of the coagulation by an electrolyte as was suggested by Powis and quoted in the literature." The conclusion of Mukherjee has been confirmed in the observations reported above. Thus the mercuric sulfide hydrosol containing 40% of alcohol was coagulated in the presence of 1.352 milliequivalents per liter of  $CaCl_2$  when the  $\zeta$ -potential was  $-57.2$ , while precipitation was more rapid in the presence of 13.5 milliequivalents of  $CaCl_2$  per liter, when the  $\zeta$ -potential was  $-77.2$ . Similarly, the mercuric sulfide hydrosol containing 20 percent propyl alcohol was not coagulated at all in 48 hours in the presence of 3 or 4 milliequivalents of LiCl per liter where the dielectric constant was  $-71.8$  while in the presence of 15 milliequivalents per liter of salt, precipitation was complete in 24 hours although the  $\zeta$ -potential was 76.2.

Since the coagulation occurs at a higher cataphoretic speed than can be accounted for by an increase in dielectric constant from the presence of electrolytes, Mukherjee suggests: "One way out of this difficulty would be on the basis that the cataphoretic speed is proportional to the product of the surface density and the thickness of the double layer and to assume that the thickness of the double layer depends on the dielectric constant so that the density of the charge is much smaller than that represented by the cataphoretic speed. An increase in the dielectric constant will also diminish the electrical work, other conditions remaining the same. Hence an increase in the dielectric constant will have a two-fold effect and it may be that the net electrical work will be less than that for the approach of two particles of the original sol. As we have no reliable data on the dielectric constant of so highly conducting solutions these considerations are not very useful."

<sup>1</sup> Colloid Symposium Monograph, 4, 308 (1926); Z. physik. Chem., 130, 170 (1927).

<sup>2</sup> Cf. however, Freundlich and Zeh: Z. physik. Chem., 114, 65 (1924).

<sup>3</sup> J. Indian Chem. Soc., 5, 707 (1928); Cf. also, Mukherjee and Choudhury: 2, 296 (1925); Mukherjee, Chaudhury and Rao Choudhury: 4, 493 (1927).

While Mukherjee is doubtless correct in pointing out that the cataphoretic speed or the  $\zeta$ -potential calculated therefrom is not a necessary measure of the stability of a sol, his suggestions as to the cause of the apparently anomalous behavior are admittedly of little help. The following considerations have an important bearing on this question: A study of the properties of the solutions of dyes<sup>1</sup> such as Congo red discloses that they diffuse but slightly, if at all, through parchment membranes. This is accounted for by assuming that the Congo red anions are associated into colloidal ions or ionic micelles. An apparent objection to this assumption is that the high conductivity of the salt solutions would require large colloidal ions to have a relatively large migration velocity, contrary to what one might expect, *a priori*. This difficulty disappears in the light of McBain's observations on soap solutions. He found<sup>2</sup> the anions in certain solutions to be colloidal ions or ionic micelles (aggregates of simple ions) possessing a mobility of the order of magnitude of that for the potassium ion. The slow migration velocity of large ions such as palmitate is due to its one electron being insufficient to charge up the ion to the surface density necessary for the average mobility. On the other hand, with the aggregates of ions, the ratio of the number of charges to the surface area is such that the particles may possess a mobility even larger than the average. Similarly, it is altogether likely that the addition of electrolytes to colloids made up of very small particles will at first decrease the mobility of the particles owing to partial neutralization of the charge by adsorption of ions of opposite charge. This is followed by coalescence of smaller particles into somewhat larger particles in which the ratio of the number of charges to the surface area is such that the mobility increases. To the extent that this factor comes in, measurements of the so-called  $\zeta$ -potential of the particles are unsatisfactory for determining the relative stability of sols.

The initial drop in  $\zeta$ -potential without coagulation in the presence of very low concentration of  $\text{CaCl}_2$  and the subsequent rise has not been reported previously. The significance of this is by no means clear but it is probably the result of an antagonistic action as it affects the adsorption of the ions of hydrogen sulfide and calcium chloride at low concentrations.

*Mercuric Sulfide Organosol + Water or Ether.* The sol was prepared in the cold by the action of  $\text{H}_2\text{S}$  on a solution of mercuric cyanide<sup>3</sup> and the  $\text{H}_2\text{S}$  was not removed completely. The particles were extremely finely divided being invisible in the cataphoresis apparatus. Addition of water increased the particle size since they became just visible when 20 percent water was added and were distinct in the presence of 40 percent water. Since the dielectric constant of the medium is raised by adding water, it is probable that the increase in size is due to growth of the particles owing to the marked solvent action of the water rather than to agglomeration. The heat conduction is

<sup>1</sup> Bayliss: Proc. Roy. Soc., 81, B, 269 (1909); 84, 229 (1912); Biltz and Vegesack: Z. physik. Chem., 73, 481 (1910); Donnan and Harris: J. Chem. Soc., 99, 1554 (1911).

<sup>2</sup> Bogue's "Colloidal Behavior," 1, 410 (1924).

<sup>3</sup> J. Phys. Chem., 34, 86 (1930).

so much lower in organic liquids than in water that localized convection currents are caused by the source of illumination, even with the most efficient light filters that were employed. Hence, the accuracy of these experiments is somewhat less than those obtained in water solutions. These currents were found to be fairly constant for each mixture, and a correction was applied to the velocity of the particles on the assumption that they affected both the cataphoretic and electro osmotic velocities uniformly.

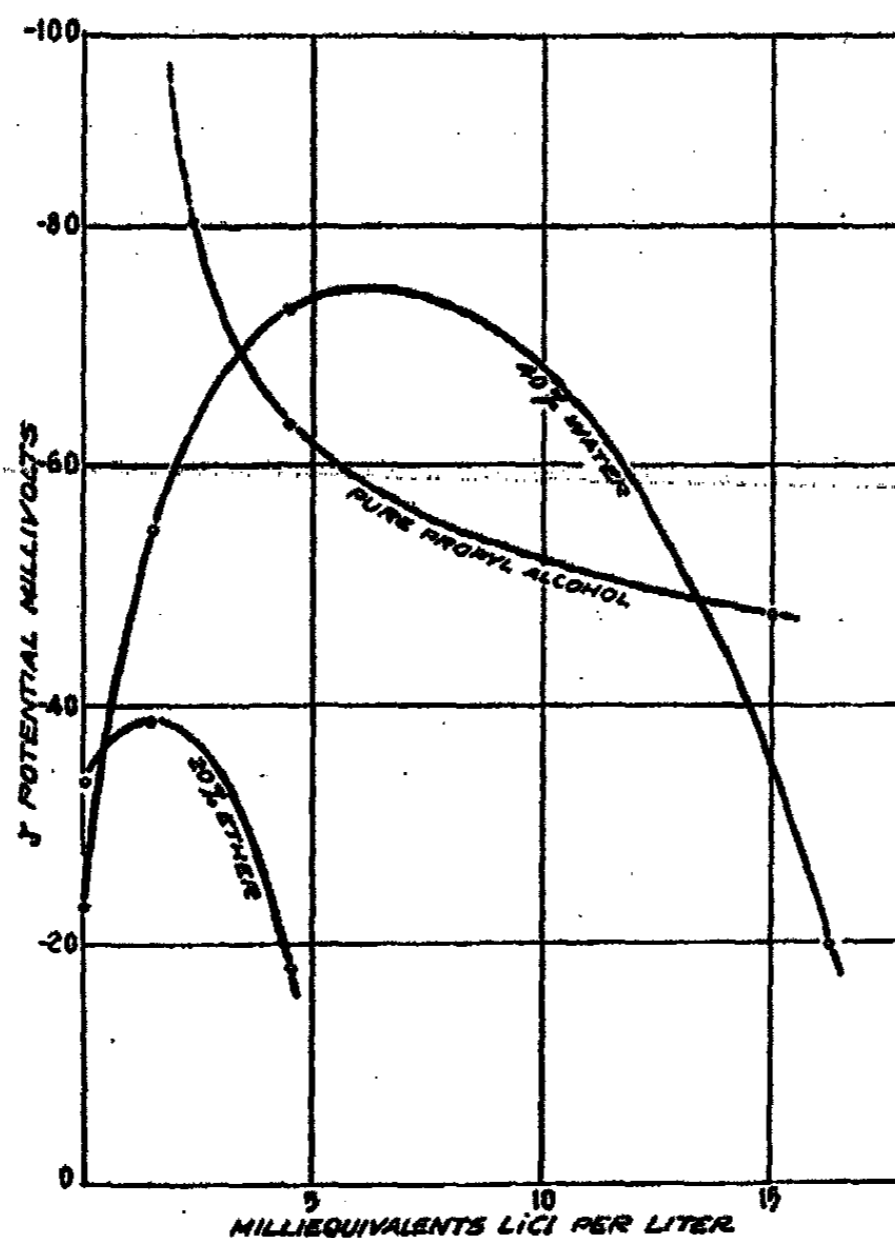

FIG. 6

$\zeta$ -potential of Particles on adding LiCl to HgS Alcosol-Water and HgS Alcosol-Ether Mixtures

The effect of water and of ether on the  $\zeta$ -potential of the particles in the absence and in the presence of lithium chloride is given in Table VIII and shown graphically in Fig. 6.

*Ferric Oxide Organosol + Benzene or Methyl Alcohol.* The ferric oxide propyl alcosol prepared as previously described<sup>1</sup> agglomerates completely on adding water, doubtless because of the relatively high electrolyte concentration. Methyl alcohol was therefore added to increase the dielectric constant of the mixture and benzene to lower it. As in the case of the mercuric sulfide organosol the particles were too small to be seen so that the  $\zeta$ -potential

<sup>1</sup> J. Phys. Chem., 34, 86 (1930).

TABLE VIII

Effect on the  $\zeta$ -potential of adding Water and Ether to HgS Propyl Alcosol

Lithium chloride milliequivalents per liter	Velocity of particles $\mu$ /sec.	Viscosity $\eta$	$\zeta$ -potential millivolts	Coagulation time
<i>Pure propyl alcohol, dielectric constant 22</i>				
2.403	-0.810	0.0192	-80.1	Precipitated, 2 hours
4.506	-0.634	0.0195	-63.5	Precipitated, 2 hours
15.02	-0.480	0.0195	-48.1	Precipitated, 2 hours
<i>40% water, dielectric constant 48.4</i>				
0.000	-0.365	0.0269	-23.3	No precipitate
1.502	-0.858	0.0269	-54.7	No precipitate
4.508	-1.146	0.0270	-73.2	No precipitate
16.43	-0.313	0.0269	-20.0	Precipitation starts 3 hours
<i>20% ether, dielectric constant 18.7</i>				
0.000	-0.49	0.0114	-33.8	No precipitate
1.502	-0.57	0.0114	-39.2	Precipitated, 1:30 hours
4.506	-0.27	0.0114	-18.6	Precipitated, 1 hour

TABLE IX

Effect on  $\zeta$ -potential of adding Methyl Alcohol and Benzene to Fe<sub>2</sub>O<sub>3</sub> Propyl Alcosol

Lithium chloride milliequivalents per liter	Velocity of particles $\mu$ /sec.	Viscosity $\eta$	$\zeta$ -potential millivolts	Coagulation time
<i>Pure propyl alcohol, dielectric constant 22</i>				
4.506	+0.260	0.0196	+26.1	Turbid, few seconds
15.02	+0.205	0.0196	+20.6	Turbid immediately
45.06	+0.250	0.0196	+25.1	Turbid immediately
90.00	+0.233	0.0190	+22.8	Very turbid
<i>20% methyl alcohol, dielectric constant 23.8</i>				
15.02	+0.273	0.0123	-16.0	Turbid, 30 seconds
45.06	+0.248	0.0123	+14.5	Turbid immediately
0.00			+ charge	
<i>40% methyl alcohol, dielectric constant 25.6</i>				
4.506	-0.117	0.0105	-5.4	Clear, 24 hours
15.02	-0.060	0.0105	-2.8	Clear, 24 hours
45.00	+0.148	0.0105	+6.9	Turbid, 3-4 minutes
0.00			slight + charge	
<i>20% Benzene, dielectric constant 17.7</i>				
0.000	+0.13	0.0137	+11.4	Clear
15.02	+0.43	0.0137	+37.7	Very slightly turbid



of the particles in the pure media could not be determined except with benzene, which causes sufficient agglomeration to render the particles visible. The results are tabulated in Table IX and shown graphically in Fig. 7.

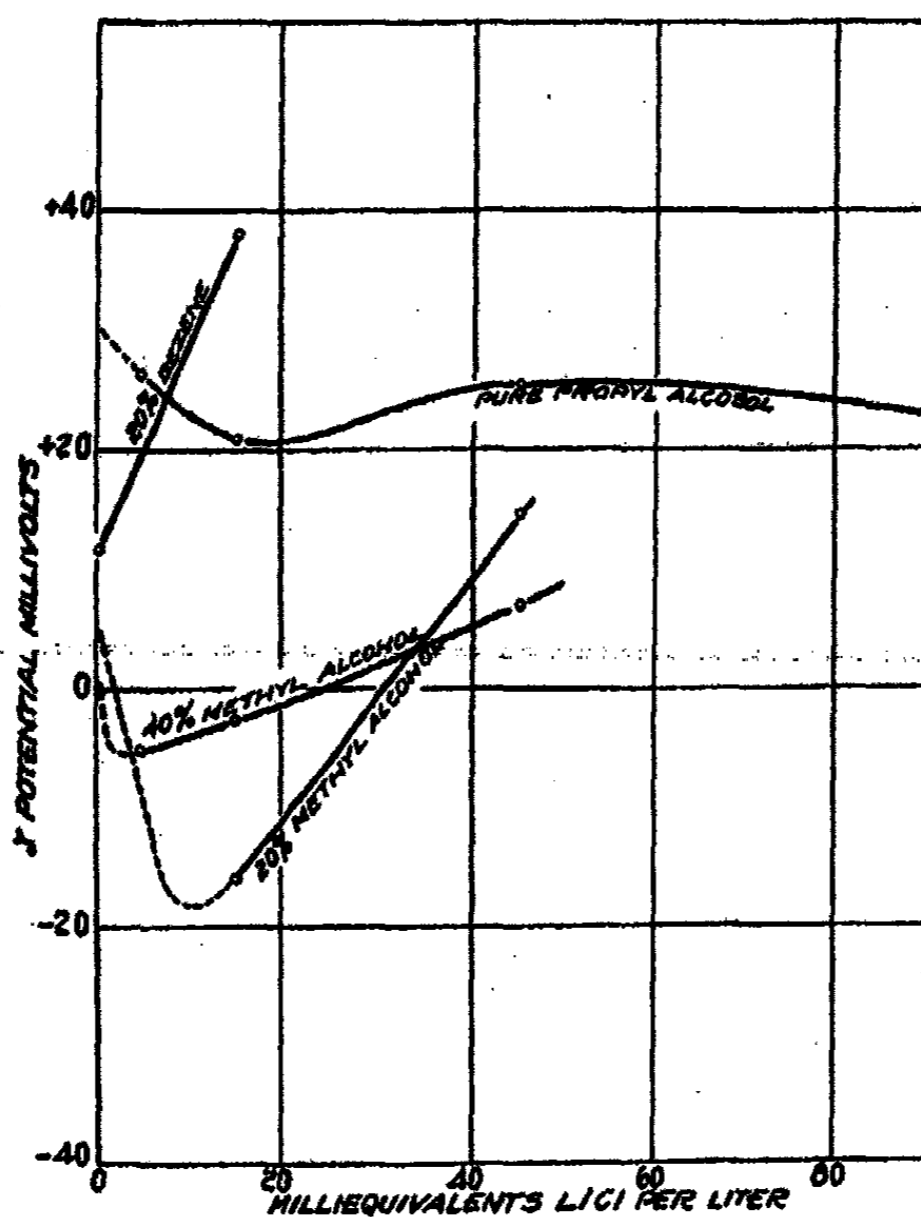

FIG. 7  
 $\zeta$ -Potential of Particles on adding LiCl to  $\text{Fe}_2\text{O}_3$  Alcosol-Benzene and  $\text{Fe}_2\text{O}_3$ -Alcosol-Methyl Alcohol Mixtures

#### • Discussion of Results

The effect of one liquid on the stability of a colloidal solution in another was at first attributed exclusively to the change in dielectric constant. Thus Wolfgang Ostwald<sup>1</sup> and Cassuto<sup>2</sup> noted that organic liquids in general have a sensitizing action on hydrosols which was attributed to the lowering of the dielectric constant. Freundlich<sup>3</sup> adopted this view-point and showed by the use of the Helmholtz equation, how a lowering of the dielectric constant would produce a lowering of the charge on the particle. In confirmation of this view, Keeser<sup>4</sup> found that urea and glycooll which increase the dielectric constant of water stabilize an  $\text{As}_2\text{S}_3$  sol toward electrolytes. On the other hand, Mukherjee<sup>5</sup> showed that the addition of urea to  $\text{As}_2\text{S}_3$  hydrosol de-

<sup>1</sup> "Grundriss der Kolloidchemie," 441 (1909).

<sup>2</sup> "Der kolloide Zustand der Materie," 152 (1913).

<sup>3</sup> "Kapillarchemie," 637 (1922).

<sup>4</sup> Biochem. Z., 157, 166 (1925).

<sup>5</sup> J. Indian Chem. Soc., 5, 697 (1928).

creases the cataphoretic migration velocity of the particles. Sugar which is usually regarded as a stabilizer likewise decreases the migration velocity of colloidal  $As_2S_3$  particles. As we have seen, however, the cataphoretic speed, or the  $\zeta$ -potential calculated therefrom, is not a necessary measure of the stability of a sol.

While the dielectric constant is undoubtedly an important factor, it is certainly not the only one. Weiser<sup>1</sup> suggests that the addition of a non-electrolyte to a hydrosol may influence the precipitation value of electrolytes for the sol by cutting down the adsorption of the precipitating ion or by displacing the stabilizing ion. The two actions being antagonistic, the precipitation concentration of an electrolyte may be either raised, lowered, or remain unchanged under otherwise constant conditions. Thus in a specific case, the addition of phenol to an  $As_2S_3$  sol increased the precipitation value of barium chloride but the sol was actually sensitized in the sense that less barium ion needed to be adsorbed to effect coagulation. The fact that a higher concentration of barium ion was necessary to cause precipitation was due to the marked cutting down of the adsorption of barium ion by phenol. Mukherjee<sup>2</sup> discounts the importance of this observation on the ground that the adsorbed barium ion may be either in the mobile or the fixed sheath of the double layer. Sen<sup>3</sup> likewise points out that the cutting down of adsorption of precipitating ions by adsorption of non-electrolytes on the particles of a sol is not general. Thus he observed a stabilization of manganese dioxide sol toward coagulation by copper sulfate in the presence of sugar or ethyl alcohol which were found to increase instead of decrease the adsorption of copper ion by air-dried  $MnO_2$ . These observations are not conclusive since the increase in adsorption of copper sulfate by air-dried manganese dioxide in the presence of alcohol or sugar gives no definite indication of the effect of alcohol or sugar on the adsorption of copper ion by manganese dioxide sol at constant hydrogen ion concentration. Chaudhury<sup>4</sup> reports recently that methyl alcohol sensitizes arsenic trisulfide sol against precipitation by barium chloride while the adsorption of barium ion increases at first and then decreases in the presence of increasing amounts of the alcohol. On the other hand, ethyl alcohol stabilizes the sols toward barium chloride while the adsorption of barium ion decreases at first and then increases in the presence of increasing amounts of alcohol. Mukherjee<sup>5</sup> found that both methyl and ethyl alcohol sensitize arsenic trisulfide sol toward HCl, KCl, and  $AlCl_3$ . If the facts are as stated it is obvious that the situation is quite involved. In addition to the effect on the dielectric constant and on the adsorption of ions following the addition of a foreign liquid to a sol, Chaudhury brings in the effect of the change in interfacial tension between the colloidal particles and the surrounding medium in order to furnish a basis of explanation for all his observations.

<sup>1</sup> J. Phys. Chem., 28, 1254 (1924).

<sup>2</sup> Mukherjee, Chaudhury, and Mukherjee: J. Indian Chem. Soc., 3, 349 (1926).

<sup>3</sup> Kolloid-Z., 38, 310 (1926).

<sup>4</sup> J. Phys. Chem., 32, 1485 (1928).

<sup>5</sup> J. Indian Chem. Soc., 3, 349 (1926).

While the change in interfacial tension would be expected to have an effect on the tendency of particles to coalesce, it is unfortunate to be forced to attribute too much effect to factors that cannot be measured and which may have a relatively small effect, as compared to the change in dielectric constant and in the adsorption of precipitating and stabilizing ions. In this connection it should be mentioned that the solvation of particles may be influenced to a marked degree by the solvation of adsorbed ions<sup>1</sup> and therefore that any factor which will change the adsorption of the ions will affect the solvation of the particles and hence the stability of the sol.

For the present it would seem that the influence of foreign non-electrolytes on the stability of lyophobic sols can be accounted for at least qualitatively by considering: (1) the effect on the dielectric constant of the medium (2) the effect on the ionization of the electrolytes present and (3) the effect on selective adsorption of ions by the colloidal particles. It will probably be found that these are the most important factors. In any event such considerations furnish the basis for further quantitative experimentation and this after all is the crying need at the present time. For without more quantitative data and without confirmation of some of the existing quantitative data, it is not known to what extent we shall have to call on non-measurable variables to explain the facts. Some specific cases will be considered.

The addition of a non-electrolyte to a very pure sol will tend to increase or decrease the stability depending on the change of dielectric constant and on the extent to which the selective ionic adsorption is altered. Thus Billitzer<sup>2</sup> found alcohol to sensitize platinum hydrosol and even to reverse the charge. Other similar examples among negative sols are the sensitization, (1) of  $As_2S_3$  and Au hydrosols on adding alcohol,<sup>3</sup> (2) of  $As_2S_3$  sol on adding phenol and isoamyl alcohol,<sup>4</sup> and (3) of HgS hydrosol on adding propyl alcohol and of HgS propyl alcocol on adding isoamyl alcohol (See Fig. 2). The greatly decreased slope of the propyl alcocol-isoamyl alcohol curve is due to the smaller lowering of the dielectric constant as compared with that resulting from the addition of propyl alcohol to the hydrosol and the absence of marked displacement of the stabilizing ion in the former case. Among the positive sols, Freundlich and Rona<sup>5</sup> showed that the addition of camphor, thymol, and urethane to ferric oxide hydrosol reduced the precipitation concentration of KCl and Weiser<sup>6</sup> found the same to be true for the action of phenol and isoamyl alcohol on the sols of chromic oxide and ferric oxide. In Table V, it was reported that the addition of propyl alcohol and acetone decrease the  $\zeta$ -potential of Péan de St. Gilles ferric oxide sol. The sensitization of the positive hydrous oxide sols is less marked than in the case of the

<sup>1</sup> Weiser and Cunningham: Colloid Symposium Monograph, 6, 319 (1928); J. Phys. Chem., 33, 301 (1929).

<sup>2</sup> Z. physik. Chem., 45, 312 (1903).

<sup>3</sup> Klein: Kolloid-Z., 29, 247 (1921).

<sup>4</sup> Weiser: J. Phys. Chem., 28, 1254 (1924).

<sup>5</sup> Biochem. Z., 81, 87 (1917).

<sup>6</sup> J. Phys. Chem., 28, 1253 (1924).

negative sols probably because of the smaller displacement of the strongly adsorbed hydrogen ion which gives the oxide sols their stability.

The reverse case of adding a liquid of high dielectric constant to a pure sol is illustrated by the increased stability on adding water to a pure mercuric sulfide propyl alcosol, Table II and Fig. 2.

The effects of adding a non-electrolyte to a sol containing excess of stabilizing electrolyte may be more difficult to explain since all of the several factors mentioned above may come in. This is illustrated by mercuric sulfide hydrosol and organosol containing an excess of hydrogen sulfide which has a marked stabilizing action. When water is added to the mercuric sulfide propyl alcosol, the extremely fine particles grow and age as a result of the solvent action of the water. This ageing causes adsorption reversal<sup>1</sup> and so the initial effect is a decrease in stability even though the dielectric constant is raised. After the initial ageing, the stability of the sol toward precipitation by LiCl (Table VIII, Fig. 6) is increased just as we have seen to be the case with a mercuric sulfide sol formed by peptizing the precipitated salt and washing free from H<sub>2</sub>S. Here again there is no apparent connection between stability toward electrolytes and the  $\zeta$ -potential. Thus in the presence of 4.5 milliequivalents of LiCl per liter, precipitation of the water-free alcosol is complete in 2 hours when the  $\zeta$ -potential is 63.5 while in the presence of a like amount of salt the alcosol with 40 percent of water is not precipitated at all in 12 hours although the  $\zeta$ -potential is approximately the same.

The effect of adding propyl alcohol to the hydrosol containing H<sub>2</sub>S is qualitatively the opposite of the effect of adding water to the alcosol. (Table VII, Fig. 4).

The propyl alcosol of ferric oxide is apparently stabilized toward electrolytes by benzene and sensitized by methyl alcohol. (Table IX, Fig. 7). Since the differences in dielectric constant are not marked, the main effect of the foreign liquid is probably on the degree of ionization of electrolytes present. The increase in ionization on addition of methyl alcohol soon approaches a limit so that in the presence of an excess of electrolyte, higher concentrations of the alcohol produce stabilization owing to the increased dielectric constant. In this case the sol is so near the isoelectric point that reversal of charge occurs. An interesting confirmation of this result was obtained by placing the sol in a Burton U-tube and allowing a concentrated salt solution to diffuse into it from the filling tube. The boundary first moved very slowly toward the anode; then reversed its direction toward the cathode; and after a good deal of salt had diffused into the solution, it moved once more toward the anode.

Finally, any conclusions based on measurements of the so-called  $\zeta$ -potential would seem to be of doubtful value until we know more about what the  $\zeta$ -potential really is and what factors affect it. It is believed that more trust-

<sup>1</sup> Freundlich and Schucht: *Z. physik. Chem.*, 85, 660 (1913); Freundlich and Hase: 89, 417 (1915).

worthy information of the effect of foreign non-electrolytes on the stability of sols can be obtained by a study of the change in precipitation concentrations of electrolytes for monodisperse sols.

#### Summary

The results of this paper may be summarized as follows:

1. Observations have been made of the effect of water and organic liquids on the stability of certain organosols stabilized by the preferential adsorption of ions and of the effect of adding organic liquids to the corresponding hydrosols. The precipitation concentration of electrolytes and the so-called  $\zeta$ -potential of the particles as given by cataphoresis experiments were used as a measure of the stability of the sols.

2. In colloidal electrolytes such as Congo red and the soaps, the colloidal ions or ionic micelles (aggregates of ions) have a relatively high mobility. The slow migration velocity of large ions such as palmitate is due to its one electron being insufficient to charge up the ion to the current density necessary for the average mobility. On the other hand with the aggregates of ions, the ratio of charge to the surface area is such that the particle may possess a mobility even larger than the average. Similarly, the addition of electrolytes to sols containing very minute particles decreases the mobility of the particles owing to partial neutralization of the charge by adsorption of ions of opposite charge. This is followed by coalescence of the small particles into somewhat larger particles on which the ratio of the number of charges to the surface area is such that the mobility increases. To the extent that this factor comes in, measurements of the so-called  $\zeta$ -potential of the particles are unsatisfactory for determining the relative stability of sols.

3. Mukherjee's observation has been confirmed that the coagulation of electrolytes by sols does not take place necessarily at a definite critical  $\zeta$ -potential. One reason for this is given in 2.

4. In general, the precipitation concentration of electrolytes for sols would seem to give a more satisfactory measure of the stability under varying conditions, than the  $\zeta$ -potential measurements.

5. The influence of foreign non-electrolytes on the stability of lyophobic hydrosols and organosols, can be accounted for at least qualitatively by considering (1) the effect on the dielectric constant of the medium, (2) the effect on the ionization of the electrolytes present (3) the effect on the selective adsorption of ions by the colloidal particles. Without more quantitative data and without confirmation of some of the existing data, it is not known to what extent we shall have to call on non-measurable or difficultly measurable variables such as interfacial tension at the particle-liquid interface and the dielectric constant of highly conducting solutions, in order to explain the behavior under certain conditions.

6. In general, the addition of foreign non-electrolytes to highly purified hydrosols or organosols, increases or decreases the stability of the sols toward electrolytes according as the dielectric constant is raised or lowered.

*The Rice Institute,  
Houston, Texas.*

## INFLUENCE OF LIGHT ON THE COAGULATION, ELECTRICAL CONDUCTIVITY, AND THE ABSORPTION SPECTRA OF SOME COLLOIDS

BY MISS S. ROY AND N. R. DHAR

Very little systematic work has been undertaken on the Influence of light on different colloids. Individual cases have been taken up from time to time.<sup>1</sup>

Some years ago Young and Pingree<sup>2</sup> showed that the cataphoretic movement of sols like  $\text{Fe}(\text{OH})_3$ ,  $\text{As}_2\text{S}_3$ , etc., decreases on illumination of the sol by arc light, whilst sols of mastic, common rosin, chlorophyll, etc., show increased cataphoretic movement on illumination.

In a foregoing paper<sup>3</sup> published from these laboratories the effect of sunlight on numerous sols was investigated. In several cases it was proved that light has a coagulating effect. It was observed that several sulphide sols when acted upon by sunlight in presence of air are oxidised with the formation of colloidal sulphur.

In this communication we have investigated the influence of sunlight, and in certain cases light from a point-o-lite lamp with suitable light filters on different sols.

We have determined the coagulation point, electric conductivity and absorption spectra of the sols; after exposure to light and the original unexposed sols, by a quartz spectrograph under exactly comparable conditions.

From our experimental results it will be clear that sols can be divided into two groups, in one group, the stability of the sol is decreased on exposure, whilst in the other group the stability increases on exposure.

### Experimental

The sols were exposed to light for definite periods in glass or silica flasks or tubes. In order to determine the coagulating power of different electrolytes, a measured volume of the sol was taken in a clean test tube and made up to 5 c.c.; whilst a known amount of standard solutions of an electrolyte was taken in another tube and was also made up to 5 c.c. The two solutions were now mixed carefully. In order to ensure complete mixing of the sol and the electrolyte, the mixture was poured and repoured several times. The volume of the mixture of sol and electrolyte was always 10 c.c.; and the time allowed for noting the coagulation was one hour.

The electric conductivity of the sols was determined in a cell of the Arrhenius type with the electrodes near each other, as the resistance of the sols in many cases was high. The measurements were conducted in a thermostat, the temperature being kept at  $30^\circ$ . The absorption spectra were deter-

<sup>1</sup> Compare Freundlich: "Colloid and Capillary Chemistry," 485.

<sup>2</sup> J. Phys. Chem., 17, 657 (1913).

<sup>3</sup> Kolloid-Z., 31, 16 (1922).

mined by a large Hilger quartz spectrograph. The sols were diluted and put in a rectangular quartz vessel. In all cases panchromatic plates were used.

*Odén Sulphur.*

Small amounts of sulphuric acid of density 1.84 were added to a 3 Normal solution of sodium thiosulphate which was cooled by water. Steps were taken that the temperature did not appreciably increase. In the first sample of the sol, the sulphuric acid added was in excess, whilst in the second sample the thiosulphate was in excess.

The mixture thus prepared was dialysed for about ten days. The sol thus obtained when acid was in excess was white in colour; whilst the sol prepared in presence of excess of thiosulphate was yellowish white. We have to emphasize that this method of preparing the sol is more convenient and seems to be better than the procedure adopted by Odén.

The sol is highly sensitive to light; and the sols prepared in presence of excess of acid or thiosulphate, coagulated readily on exposure to light.

The following are the results obtained with the sol prepared in excess of acid:—

TABLE I

Concentration = 0.29 gr. sulphur per litre.

Volume of mixture = 10 c.c.

Amount of sol taken = 0.5 c.c.

Time of coagulation = 1 hour.

Electrolyte	Concentration	Amount needed for coagulation	
KCl	N	1.2 c.c.	Unexposed sol
BaCl <sub>2</sub>	N/250	1.5 c.c.	" "

The same sol coagulated on exposure to sunlight after six hours in a glass vessel.

The following results were obtained in the measurement of electric conductivity for the unexposed and the exposed sols just before coagulation.

Date	Specific conductivity for unexposed sol at 30°	Specific conductivity at 30° for exposed sol
18.10.27	$1.58 \times 10^{-4}$	$1.22 \times 10^{-4}$ Exposed for 4 hrs.
24.10.27	$1.57 \times 10^{-4}$	$1.21 \times 10^{-4}$ Exposed for 5½ hrs.

The following results were obtained with the sol prepared in excess of thiosulphate.

Concentration of the sol = 8.63 grms. of sulphur per litre.

Volume of mixture = 10 c.c.

Sol taken = 1 c.c.

Time for coagulation = 1 hour.

Electrolyte	Concentration	Amount of electrolyte needed for coagulation	
KCl	N/10	7.50 c.c.	Unexposed.
BaCl <sub>2</sub>	N/100	0.04 c.c.	"
Ce(NO <sub>3</sub> ) <sub>3</sub>	N/200	3.5 c.c.	"
Th(NO <sub>3</sub> ) <sub>4</sub>	N/200	0.55 c.c.	"

This sol is more sensitive to light than that prepared in presence of an excess of sulphuric acid and it begins to coagulate on exposure to sunlight in a quartz vessel in 45 minutes and the coagulation is complete on exposure for two and a half hours.

The electric conductivity measurements are recorded below:—

Date	Sp. conductivity for unexposed sol.	Sp. conductivity for exposed sol.
22.11.27.	$2.66 \times 10^{-3}$ .	$2.68 \times 10^{-3}$ Exposed for $7\frac{1}{2}$ hrs.
16.1.28.	$2.74 \times 10^{-3}$ .	$3.93 \times 10^{-3}$ Exposed for 100 hrs.

(2) *Prussian Blue.*

Dilute solutions of ferric chloride and potassium ferrocyanide were carefully mixed and a small quantity of ammonium oxalate was added as a peptising agent. This mixture was then dialysed for twelve days and a clear deep blue sol of Prussian blue was obtained.

Concentration of the sol = 9.33 grms. per liter.

Volume of mixture = 10 c.c.

Amount of sol taken = 1 c.c.

Time = 1 hour.

Electrolyte	Concentration	Amount needed for coagulation
KCl	N/2.5	1.65 c.c. Unexposed
		1.80 c.c. Exposed for 1 hour
BaCl <sub>2</sub>	N/100	1.90 c.c. Exposed for $11\frac{1}{2}$ hrs.
		1.30 c.c. Unexposed
Ce(NO <sub>3</sub> ) <sub>3</sub>	N/200	1.40 c.c. Exposed for $11\frac{1}{2}$ hrs.
		1.69 c.c. Unexposed
		1.67 c.c. Exposed for $11\frac{1}{2}$ hrs.

The same sol was diluted ten times and the diluted sol was exposed to sunlight for 100 hours, and the following results were obtained:—

Volume of mixture = 10 c.c.

Amount of sol taken = 1 c.c.

Time for coagulation = 1 hour.

Electrolyte	Concentration,	Amount needed for coagulation
KCl	N	1.0 c.c. Unexposed
		1.6 c.c. Exposed

Electric conductivity measurements of the concentrated sol:—

Date	Sp. conductivity for unexposed sol.	Sp. conductivity for exposed sol.
31.8.27.	$3.96 \times 10^{-4}$ .	$3.65 \times 10^{-4}$ Exposed for 4 hrs.
8.9.27.	$3.76 \times 10^{-4}$ .	$3.16 \times 10^{-4}$ Exposed for 1 hr. in another tube
20.9.27.	$3.75 \times 10^{-4}$ .	$3.56 \times 10^{-4}$ Exposed for 10 hrs.
11.1.28.	$3.4 \times 10^{-4}$ .	$8.7 \times 10^{-4}$ Exposed for 100 hrs.



In this case the sol was exposed to light from a point-o-lite lamp using different light filters and the electric conductivities were measured.

The following results are obtained:—

Sp. conductivity for unexposed sol.	Sp. conductivity for the sol exposed for 8½ hours.	
$3.76 \times 10^{-4}$ .	$3.6 \times 10^{-4}$ .	Wave length = 7054 Å.
	$3.63 \times 10^{-4}$ .	" = 6454 Å.
	$3.56 \times 10^{-4}$ .	" = 4350 Å.

Electric conductivity results obtained with the dilute sol:—

Specific conductivity for unexposed sol.	Specific conductivity for exposed sol.
$7.9 \times 10^{-5}$ .	$2.4 \times 10^{-4}$ Exposed for 100 hrs.

(3) *Copper Ferrocyanide.*

Dilute solutions of cupric sulphate and potassium ferrocyanide were mixed, potassium ferrocyanide being in slight excess and the mixture was allowed to dialyse for 10 days with occasional stirring.

Concentration of the sol = 3.1 grms. of cupric ferrocyanide per litre.

Volume of the mixture = 10 c.c.

Sol taken = 1 c.c.

Time for coagulation = 1 hour.

Electrolyte	Concentration	Amount needed for coagulation
KCl	N	0.6 c.c. Unexposed sol.
		0.9 c.c. Exposed for 20 hrs.
BaCl <sub>2</sub>	N/500	0.45 c.c. Unexposed sol.
		0.50 c.c. Exposed sol.
Ce(NO <sub>3</sub> ) <sub>3</sub>	N/200	1.0 c.c. Unexposed sol.
		1.02 c.c. Exposed
Th(NO <sub>3</sub> ) <sub>4</sub>	N/200	4.5 c.c. Unexposed sol.
		4.55 c.c. Exposed

Electric conductivity measurements:—

Date	Specific conductivity of unexposed sol.	Specific conductivity for exposed sol.
5.12.27	$2.35 \times 10^{-3}$	
11.1.28	$2.17 \times 10^{-3}$	$3.17 \times 10^{-3}$ exposed for 100 hrs

The sol was diluted ten times and was exposed to sunlight and the coagulation began after 9 hours' exposure and was complete in twelve hours.

(4) *Zirconium Hydroxide.*

Concentrated solution of zirconium nitrate was added to boiling water and the boiling was continued for an hour. The clear transparent sol thus obtained was dialysed for 10 days.

Concentration of sol = 15.65 grms. of  $ZrO_2$  per litre.

Volume of the mixture = 10 c.c.

Sol taken = 1 c.c.

Time for coagulation = 1 hour.

Electrolyte	Concentration	Amount needed for coagulation
KCl	N	1.95 c.c. Unexposed 1.90 c.c. Exposed for 20 hrs.
$K_2SO_4$	N/50	1.05 c.c. Unexposed 0.95 c.c. Exposed
Potassium citrate	N/80	1.70 c.c. Unexposed 1.65 c.c. Exposed
$K_4Fe(CN)_6$	N/100	0.90 c.c. Unexposed 0.90 c.c. Exposed

The electric conductivity measurements are as follows:—

Sp. conductivity for unexposed sol.

$$1.2 \times 10^{-3}$$

Sp. conductivity for exposed sol.

$$1.3 \times 10^{-3} \text{ Exposed for 100 hrs.}$$

(5) *Chromium Hydroxide.*

This sol was prepared by the action of ammonium carbonate on a solution of chromium trichloride at  $20^\circ$  till the precipitate of chromium hydroxide formed redissolved. The sol thus prepared was dialysed for 17 days.

Concentration of the sol = 1.725 grms. of  $Cr_2O_3$  per litre.

Volume of the mixture = 10 c.c.

Sol taken = 2 c.c.

Time for coagulation = 1 hour.

Electrolyte	Concentration	Amount for coagulation
KCl	2N	Could not be coagulated.
$K_2SO_4$	N/50	1.25 c.c. Unexposed 1.15 c.c. Exposed for 10 hrs.
Potassium Citrate	N/80	1.10 c.c. Unexposed 1.05 c.c. Exposed
$K_4Fe(CN)_6$	N/100	0.80 c.c. Unexposed 0.70 c.c. Exposed

Electric conductivity measurements.

Sp. conductivity for unexposed sol.

$$1.27 \times 10^{-3}$$

Sp. conductivity for exposed sol.

$$1.51 \times 10^{-3} \text{ Exposed for 40 hrs.}$$

(6) *Ferric Hydroxide (cold).*

Small quantities of ammonium carbonate were added to a concentrated solution of ferric chloride till the precipitate of ferric hydroxide redissolved. The sol was subjected to dialysis for six weeks.

Concentration of sol = 26.745 grms. of  $\text{Fe}_2\text{O}_3$  per litre.

Volume of the mixture = 10 c.c.

Amount of sol taken = 1 c.c.

Time for coagulation = 1 hour.

Electrolyte	Concentration	Amount needed for coagulation
KCl	N/5	1.2 c.c. Unexposed
		1.05 c.c. Exposed for 10 hrs.
$\text{K}_2\text{SO}_4$	N/500	3.90 c.c. Unexposed
		3.75 c.c. Exposed
Potassium Citrate	N/80	0.50 c.c. Unexposed
		0.30 c.c. Exposed
$\text{K}_4\text{Fe}(\text{CN})_6$	N/500	1.50 c.c. Unexposed
		1.30 c.c. Exposed
KCl	N/5	1.10 c.c. Unexposed and kept in the dark for a month
		0.95 c.c. Exposed for 100 hrs.

Electric conductivity measurements:—

Date	Sp. conductivity for unexposed sol.	Sp. conductivity for exposed sol.
23.9.27	$1.96 \times 10^{-4}$	$2.40 \times 10^{-4}$ Exposed for 10 hrs.
13.10.27		$2.99 \times 10^{-4}$ Exposed for 30 hrs.
5.1.28	$1.98 \times 10^{-4}$	$4.19 \times 10^{-4}$ Exposed for 100 hrs.

(7)  $\text{MnO}_2$  Sol (Manganese dioxide sol).

The sol was prepared by the reaction of  $\text{H}_2\text{O}_2$  on  $\text{KMnO}_4$  having an excess of unacted  $\text{KMnO}_4$ , according to the following equation:—

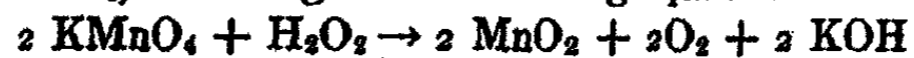

The sol was dialysed for 3 days. The sol is sensitive to sunlight and on 20 hrs. exposure to light coagulates in a glass vessel.

The following experimental results were obtained:—

Concentration of the sol = 2.20 grms.  $\text{MnO}_2$  per litre.

Volume of the mixture = 10 c.c.

Sol taken = 1 c.c.

Time = 1 hr.

Electrolyte	Concentration	Amount needed for coagulation
1.11.27 KCl	N/10	1.10 c.c. Unexposed
		0.95 c.c. Exposed for 10 hrs.
BaCl <sub>2</sub>	N/1000	0.57 c.c. Unexposed
		0.50 c.c. Exposed
7.11.27 KCl	N/10	0.35 c.c. Unexposed
		0.30 c.c. Exposed for 20 hrs.

Electric conductivity results:—

Sp. conductivity for unexposed sol.

$5.61 \times 10^{-4}$

Sp. conductivity for exposed sol (8 hours),

$5.85 \times 10^{-4}$

(8) *Ce(OH)<sub>4</sub> cold.*

25 grms of ceric-ammonium-nitrate were dissolved in 250 c.c. of water at 25°. The solution was dialysed for 6 days after filtering.

Concentration of the sol = 17.65 grms of CeO<sub>2</sub> per litre.

Volume of the mixture = 10 c.c.

Sol taken = .5 c.c.

Time for coagulation = 1 hour.

Electrolyte	Concentration	Amount needed for coagulation
KCl	N	1. c.c. Unexposed
BaCl <sub>2</sub>	N	1.2 c.c. "
K <sub>2</sub> SO <sub>4</sub>	N/250	2.1 c.c. "

when coagulation of the sol was effected by chlorides a gelatinous precipitate was obtained and the precipitate was not gelatinous when coagulated by potassium sulphate.

The sol is highly photosensitive and it readily sets to a jelly on exposure to sunlight for 2½ hours, when the sol was heated no coagulation was observed.

Electric conductivity.

Date	Sp. conductivity for unexposed sol.	Exposed sol sets to a jelly readily.
4.11.27	$2.9 \times 10^{-3}$	
12.11.27	$2.5 \times 10^{-3}$	

(9.) *Cerium Hydroxide (hot).*

25 grms. of cerium-ammonium-nitrate were dissolved in 250 c.c. of water and filtered. The solution was boiled for half an hour and was dialysed for 12 days.

Concentration of the sol = 25.32 grms. CeO<sub>2</sub> per litre.

Volume of the mixture = 10 c.c.

Amount of sol taken = 1 c.c.

Time for coagulation = 1 hour.

Electrolyte	Concentration	Amount needed for coagulation
KCl	N	3.2 c.c. Unexposed 1.1 c.c. Exposed for 10 hrs.
K <sub>2</sub> SO <sub>4</sub>	N/50	2.1 c.c. Unexposed 0.9 c.c. Exposed

Electric conductivity results:—

Date	Sp. conductivity for unexposed sol.	Sp. conductivity for exposed sol.
11.11.27	$2.2 \times 10^{-3}$	$2.8 \times 10^{-3}$ Exposed for 10 hrs.

The sol coagulated on exposure for 20 hours.

(10) *Vanadium Pentoxide.*

The sol was prepared by taking a finely powdered and weighed quantity of ammonium vanadate in a mortar to which a concentrated solution of hydrochloric-acid was added slowly till no more of red vanadic acid precipitated. The precipitate was allowed to settle and the clear liquid was decanted. The precipitate was washed 3 or 4 times by decantation with distilled water in order to free it from ammonium chloride. At this stage the precipitate of vanadic acid has a tendency to pass in the colloidal state. The precipitate was now vigorously shaken in a coloured glass bottle with distilled water, and a clear deep red coloured sol of vanadium pentoxide was obtained.

Concentration of the sol = 14.46 grms.  $V_2O_5$  per litre.

Volume of the mixture = 10 c.c.

Amount of sol taken = 0.5 c.c.

Time for coagulation = 1 hour.

Electrolyte	Concentration	Amount needed for coagulation
KCl	N/10	1.65 c.c. Unexposed
		1.55 c.c. Exposed for 8 hrs.
BaCl <sub>2</sub>	N/250	2.30 c.c. Unexposed
		2.10 c.c. Exposed

Electric conductivity measurements.

Date	Sp. conductivity for unexposed sol.	Sp. conductivity for exposed sol.
31.8.27	$3.96 \times 10^{-4}$	$3.62 \times 10^{-4}$ Exposed for 8 hrs.
20.9.27	$3.74 \times 10^{-4}$	$3.54 \times 10^{-4}$ Exposed for 30 hrs.
11.1.28	$6.70 \times 10^{-4}$	$5.38 \times 10^{-4}$ Exposed for 100 hrs.

(11) *Gum Dammar.*

A concentrated solution of gum dammar was prepared in alcohol. The alcoholic solution was poured into distilled water and the sol thus obtained was dialysed for 3 days to free it from alcohol.

Concentration of the sol = 3.54 grms. of gum dammar, per litre.

Volume of the mixture = 10 c.c.

Amount of sol taken = 1 c.c.

Time for coagulation = 1 hour.

Electrolyte	Concentration	Amount needed for coagulation
KCl	N	0.65 c.c. Unexposed
		1.0 c.c. Exposed for 20 hrs.
BaCl <sub>2</sub>	N/2.5	0.95 c.c. Unexposed
		1.85 c.c. Exposed
Ce(NO <sub>3</sub> ) <sub>3</sub>	N/200	1.10 c.c. Unexposed
		1.35 c.c. Exposed

## Electric conductivity measurements:—

Sp. conductivity for unexposed sol.

$3.5 \times 10^{-5}$

Sp. conductivity for exposed sol (20 hours).

$2 \times 10^{-5}$

(12) *Mastic.*

A concentrated alcoholic solution of mastic was poured into distilled water and the sol thus obtained was dialysed for 4 days to free it from alcohol.

Concentration of the sol = 4.28 grms. per litre.

Volume of the mixture = 10 c.c.

Amount of sol taken = 1 c.c.

Time for coagulation = 1 hour.

Electrolyte	Concentration	Amount needed for coagulation
KCl	2N	1.62 c.c. Unexposed
		2.25 c.c. Exposed to filter 1 Wavelength = 7054 Å for twelve hours
		2.30 c.c. exposed to filter no. 5 Wavelength = 6454 Å for 12 hrs.
		2.35 c.c. Exposed to filter no 9 Wavelength = 4350 Å for 12 hrs.
		2.40 c.c. Exposed to Sunlight for 2 hrs.
BaCl <sub>2</sub>	N/40	1.85 c.c. Unexposed
		2.50 c.c. Exposed to filter no. 9 Wavelength = 4350 Å
		2.80 c.c. Exposed to sunlight

## Electric conductivity measurements.

Sp. conductivity unexposed	} $8.1 \times 10^{-5}$	Sp. conductivity for sol exposed to sunlight for two hours
Sp. conductivity of sol exposed to filter 1. (Wave length = 7054 Å) for 12 hours		
Sp. conductivity of sol exposed to filter 5 (Wave length = 6454 Å) for 12 hours	} $7.6 \times 10^{-5}$	$6.2 \times 10^{-5}$
Sp. conductivity of sol exposed to filter 9 (Wave length = 4350 Å) for 12 hours		
Sp. conductivity of sol exposed to filter 9 (Wave length = 4350 Å) for 12 hours	} $7.0 \times 10^{-5}$	
Sp. conductivity of sol exposed to filter 9 (Wave length = 4350 Å) for 12 hours		
Sp. conductivity of sol exposed to filter 9 (Wave length = 4350 Å) for 12 hours	} $6.9 \times 10^{-5}$	
Sp. conductivity of sol exposed to filter 9 (Wave length = 4350 Å) for 12 hours		

(13)  $As_2S_3$ .

The sol was prepared by passing a slow current of  $H_2S$  through a solution of arsenious oxide. The excess of  $H_2S$  was removed by passing hydrogen.

Concentration of the sol = 3.29 grms.  $As_2S_3$  per litre.

Volume of the mixture = 10 c.c.

Amount of sol taken = 1 c.c.

Time for coagulation = 1 hour.

Electrolyte	Concentration	Amount needed for coagulation
KCl	N	1.0 c.c. Unexposed
		0.95 c.c. Exposed for 6 hrs.
		0.85 c.c. Exposed for 12 hrs.
$BaCl_2$	N/250	3.05 c.c. Unexposed
		2.9 c.c. Exposed for 12 hrs.
$Ce(NO_3)_3$	N/200	0.35 c.c. Unexposed
		1.0 c.c. Exposed longer for 12 hrs.
$Th(NO_3)_4$	N/200	1.30 c.c. Unexposed
		2.10 c.c. Exposed for 12 hrs.

## Electric conductivity measurements.

Date	Sp. conductivity for unexposed sol.	Sp. conductivity for exposed sol.
26.9.27	$4.5 \times 10^{-4}$	$9.4 \times 10^{-4}$ Exposed for 6 hrs.
12.10.27	$4.7 \times 10^{-4}$	$1.95 \times 10^{-3}$ Exposed for 15 hrs.

## Discussion

The experimental results on the influence of light on sols show that from the point of view of coagulation, sols can be divided into two groups:—(1) sols which become unstable towards electrolytes on exposure to light. This group consists of: ferric hydroxide, chromium hydroxide, zirconium hydroxide, vanadium pentoxide, cerium hydroxide prepared in hot and cold conditions, hydrated manganese dioxide, and Odén sulphur sols.

(2) The second group of sols consisting of Prussian blue, cupric ferrocyanide, mastic, and gum dammar, become more stable towards electrolytes on exposure to light. In the case of arsenious sulphide, on exposure to light, the sol becomes unstable when coagulated by KCl and  $BaCl_2$ . But the sol appears to be stabilised on exposure in its coagulation by  $Ce(NO_3)_3$  and  $Th(NO_3)_4$ . These complicated results are possibly associated with the oxidation of arsenious sulphide and sulphuretted hydrogen, which is a product of the hydrolysis, and the consequent formation of colloidal sulphur and thionic acids. Consequently on exposure arsenious sulphide sol contains new colloids and electrolytes.

In the case of arsenious sulphide the exposed sol shows more marked adsorption in the violet and ultraviolet part of the spectrum as shown in

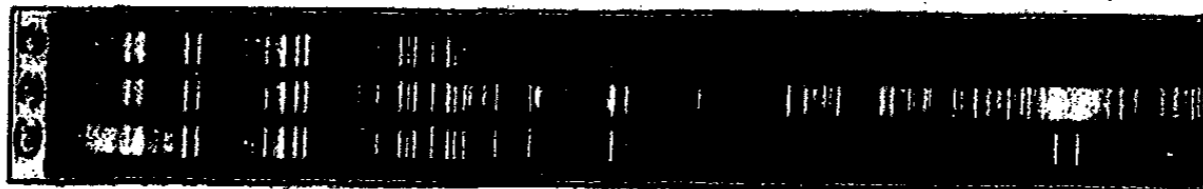

## PLATE I

 $As_2S_3$  sol

1. Absorption spectrum of exposed  $As_2S_3$  sol.
2. Absorption spectrum of copper arc.
3. Absorption spectrum of unexposed  $As_2S_3$  sol.

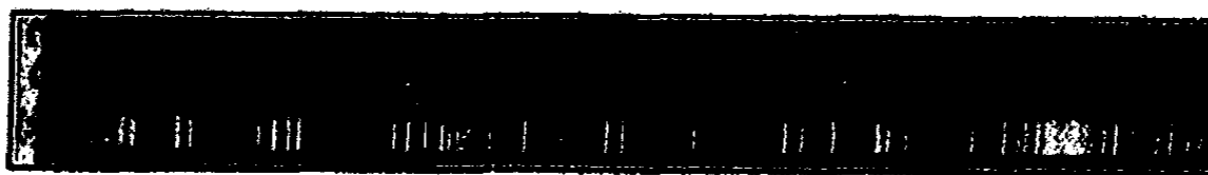

## PLATE II

## Prussian Blue

1. Absorption spectrum of exposed sol of Prussian Blue.
2. Absorption spectrum of unexposed sol of Prussian blue.
3. Absorption spectrum of copper arc.

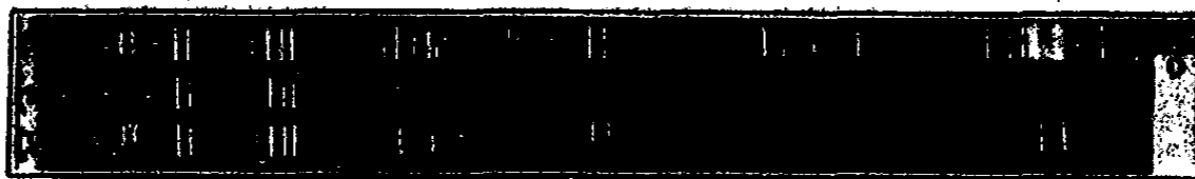

## PLATE III

## Mastic

1. Absorption spectrum of copper arc.
2. Absorption spectrum of unexposed mastic.
3. Absorption spectrum of exposed mastic.

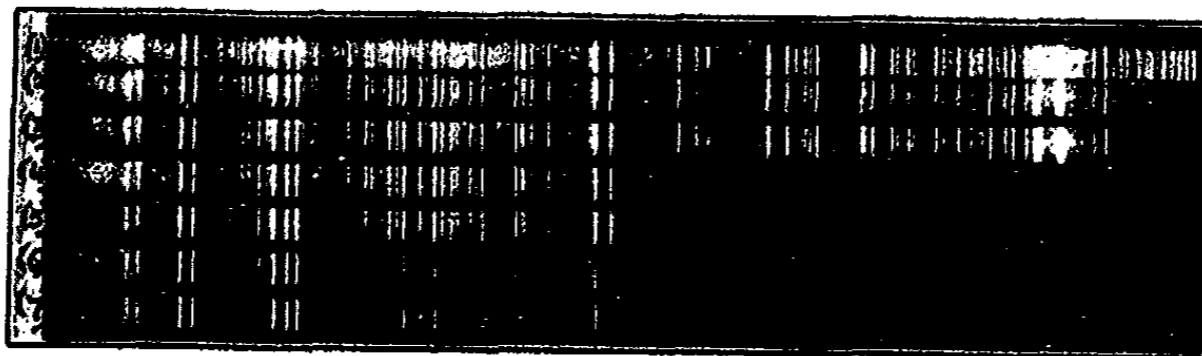

## PLATE IV

1. Absorption spectrum of copper arc.
1. Absorption spectrum of exposed silicic acid.
3. Absorption spectrum of unexposed silicic acid.
4. Absorption spectrum of unexposed  $Ce(OH)_4$  prepared in the hot condition.
5. Absorption spectrum of exposed  $Ce(OH)_4$  prepared in the hot condition.
6. Absorption spectrum of unexposed gum dammar.
7. Absorption spectrum of exposed gum dammar.



Plate I. The colour of the exposed sol was more whittish and the turbidity too was greater in the case of the exposed sol. Similarly the exposed sol of prussian blue appears more turbid and the absorption spectra reveals more marked absorption in the visible parts of the spectrum. On the other hand, an unexposed sol of mastic shows slightly greater absorption than an exposed one. Similar results though less pronounced than mastic have been obtained with gum dammar.

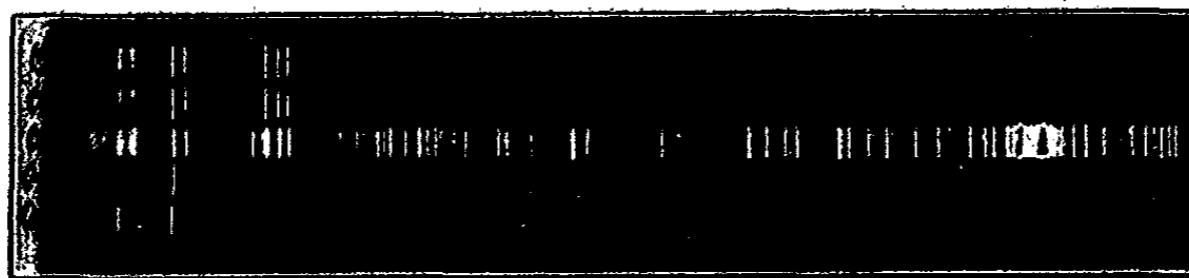

PLATE V

1. Absorption spectrum of unexposed MnO<sub>2</sub> sol.
2. Absorption spectrum of exposed MnO<sub>2</sub> sol.
3. Absorption spectrum of copper arc.
4. Absorption spectrum of exposed V<sub>2</sub>O<sub>5</sub> sol.
5. Absorption spectrum of exposed V<sub>2</sub>O<sub>5</sub> sol.

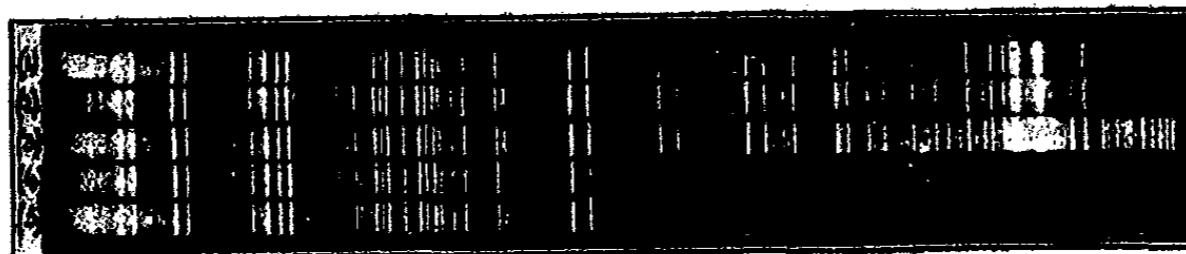

PLATE VI

1. Absorption spectrum of unexposed Cr(OH)<sub>3</sub> sol.
2. Absorption spectrum of exposed Cr(OH)<sub>3</sub> sol.
3. Absorption spectrum of copper arc.
4. Absorption spectrum of unexposed Ce(OH)<sub>4</sub> prepared in the cold condition.
5. Absorption spectrum of exposed Ce(OH)<sub>4</sub> prepared in the cold condition.

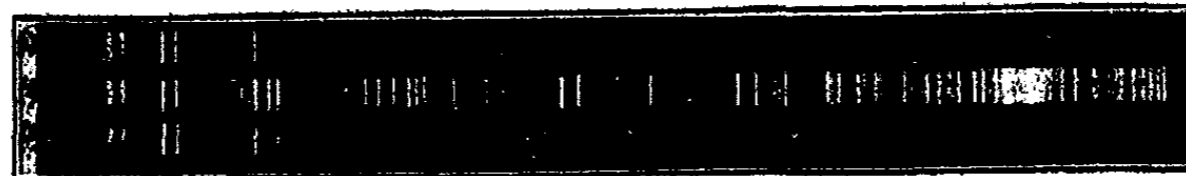

PLATE VII

Fe(OH)<sub>3</sub> sol

1. Absorption spectrum of unexposed sol.
2. Absorption spectrum of copper arc.
3. Absorption spectrum of exposed sol.

In the cases of silicic acid, vanadium pentoxide, manganese dioxide, and ceric hydroxide (prepared in the hot condition), there is hardly any difference in the absorption spectra of the exposed and unexposed sols. In the case of ferric hydroxide the exposed sol shows a slightly greater absorption than the unexposed one.

In all these cases the original sols were diluted ten times and one portion was kept in the dark and another portion was exposed to light for definite periods. For each sol the absorption spectra of the diluted unexposed and

exposed sols were taken on the same day. When the diluted sols were exposed to light for several hours, there were certain interesting colour changes. As has already been recorded the arsenious sulphide sol lost its orange colour and passed through yellowish to whitish and highly turbid condition. The Prussian blue on exposure becomes appreciably less blue and more turbid. Ferric hydroxide sol changes from its original deep brown colour to a more red tint. This behaviour of ferric hydroxide sol is similar to that of freshly prepared hydroxide precipitate. It has been repeatedly observed in these laboratories that a brownish-red precipitate of ferric hydroxide kept under water at the ordinary temperature in the dark assumes a more reddish tint with time. The vanadium pentoxide sol appeared to be more red on exposure. The opacity of a diluted mastic sol appeared slightly pronounced on exposure to sunlight. The diluted cerium hydroxide sol prepared in the cold condition becomes more turbid and whitish than the diluted unexposed sol.

The conductivity measurements show that ferric hydroxide, manganese dioxide, ceric hydroxide prepared in the hot condition, zirconium hydroxide, and chromium-hydroxide have appreciably greater electric conductivities on exposure than those of the unexposed sols. On the other hand, mastic, gum dammar and Odén's sulphur prepared in the presence of an excess of acid become less conducting on exposure.

In the cases of Prussian blue and cupric ferrocyanide the conductivities of the exposed sols are at first less than those of the unexposed sols but on longer exposure the conductivities of the exposed sols become greater than those of the unexposed sols.

In the case of arsenious sulphide, the conductivity of the exposed sol is much greater than that of the unexposed one.

With vanadium pentoxide the conductivity measurements show that the results are complicated. The conductivity of the exposed sol seems to be in certain cases appreciably less than that of the unexposed ones under identical conditions, and on longer exposure also the conductivity of the exposed sol is less than that of the unexposed one.

In the previous papers<sup>1</sup> it has been shown that the conductivity of a vanadium pentoxide sol decreases with time even in the dark and its viscosity increases with time. It appears therefore that the effect of light is the same as that of ageing. It seems rather peculiar that though vanadium pentoxide becomes more hydrated and more viscous under the influence of light than the unexposed sol, the exposed sol however is less stable towards electrolytes than the unexposed one. It is of interest to note that the conductivities of the unexposed and the exposed sols after reaching a minimum increase with time.

In the cases of mastic and gum dammar the exposed sols are less conducting and more stable towards electrolytes than the unexposed one.

In previous papers<sup>2</sup> published from these laboratories we have proved that sols like Prussian blue, cupric ferrocyanide, mastic, gum dammar, gamboge

<sup>1</sup> Kolloid-Z., 42, 124 (1927); Z. anorg. allgem. Chem., 168, 209 (1927).

<sup>2</sup> J. Phys. Chem., 29, 659 (1925); Kolloid-Z., 38, 14; 39, 346 (1926).

et. are appreciably hydrolysed in aqueous solutions and this hydrolysis makes the sol more stable towards electrolytes. Moreover we have also shown that on ageing, the sols become more hydrolysed and more stable towards electrolytes. The foregoing results show that under the influence of light these sols become more hydrolysed and more stable towards electrolytes. In the case of cupric ferrocyanide the diluted sol on exposure for a very long time coagulates.

We have also proved that the electric conductivities of sols of ferric hydroxide, chromium hydroxide, cerium hydroxide prepared in the hot condition, aluminium hydroxide and manganese dioxide become greater on ageing.

We have also shown that on ageing the adsorptive power and reactivity of the particles become less. Hence it appears that on exposure to light, the phenomenon of ageing is accentuated and the adsorbed ions which render the sols stable are given out and hence greater conductivity and less stability are observed with the hydroxide sols.

With arsenious sulphide the results are very peculiar, the electric conductivity goes on increasing at a rapid rate on exposure. In this respect the influence of light is again an accentuation of the phenomenon of ageing which also makes the sol more conducting in the dark. The stability of the sol on exposure towards KCl and BaCl<sub>2</sub> decreases steadily, but in the cases of Ce(NO<sub>3</sub>)<sub>3</sub> and Th(NO<sub>3</sub>)<sub>4</sub> the sol becomes more stable. This discrepancy is certainly due to the fact that arsenious sulphide sol on exposure not only generates hydrogen sulphide but colloidal sulphur, thionic acids etc. are also produced. The increase of conductivity on exposure is possibly due to the generation of the thionic acids.

Though Odén sulphur sol prepared in presence of excess of thiosulphate or sulphuric acid readily coagulates on exposure to light there seems to be a difference in the conductivity results. The decrease of conductivity on exposure in the case of the sol prepared in presence of an excess of acid is possibly due to the decomposition of the thionic acids which are always present in sulphur sols.

Fernau and Pauli<sup>1</sup> have shown that a sol of ceric hydroxide prepared in the cold can be readily coagulated by radium rays. We have observed that the same sol can be readily coagulated by sunlight, and it forms a stiff jelly. The sol of ceric hydroxide prepared in the hot condition also coagulates to gelatinous precipitate on longer exposure to light. The jelly obtained by the coagulation of the ceric hydroxide prepared in the cold when further exposed to light undergoes syneresis and a gelatinous precipitate and a clear liquid separate. We have also observed that Odén's sulphur sol prepared either in presence of an excess of acid or sodium thiosulphate readily coagulates completely on exposure to sunlight in glass vessels. Similarly a diluted sol of cupric ferrocyanide also coagulates completely when exposed to sunlight for 12 hours, coagulation begins after 9 hours exposure. Moreover, a sol of manganese dioxide does not coagulate easily in glass vessels but coagulates in

<sup>1</sup> Kolloid-Z., 20, 20 (1917).

a quartz vessel after exposure to sunlight for 2 hours, the coagulation begins even after 20 minutes' exposure.

Our experimental results show that in general the effect of light on sols is in the same direction as that of ageing. The light effect is much more pronounced than the time effect.

From the foregoing results we can conclude that the coagulation of a sol by light is mainly due to two causes:—

(1) The decomposition of the stabilising ion and (2) loss of reactivity of the sol particles and its consequent giving up of the adsorbed electrolyte. Of these two causes the decomposition of the stabilising ions is the more important factor in causing coagulation. Ceric hydroxide prepared in the hot and cold conditions are readily coagulated on exposure to sunlight and it appears that ceric ion which is the stabilising ion decomposes and we get a smell of  $H_2O_2$  or  $O_3$  from a sol of ceric hydroxide. Manganese dioxide sol also readily coagulates by light and it is well known that it is stabilised by permanganate ion, which is photosensitive. Similarly coagulation of Odén sulphur sol is possibly due to the decomposition of thionic acids. Moreover, the coagulation of a diluted sol of cupric ferrocyanide is caused by the decomposition of the ferrocyanide ion, which is the stabilising agent in the ferrocyanide sols.

Our measurements of light absorption by the exposed and unexposed sols though still incomplete show certain interesting relations. The exposed ferric hydroxide sol shows more absorption than the unexposed one, and we have also proved that the exposed sol is less stable towards electrolytes. Hence exposure to light is likely to make the particles of ferric hydroxide sol larger. Similarly in the case of arsenious sulphide the exposed sol shows more marked absorption of light than the unexposed sol. In this case, also the particles grow on exposure to light as revealed by the lesser stability of the exposed sol. On the other hand, in the cases of mastic and gum dammar the exposed sols show slightly less absorption of light than the unexposed sols. Moreover the exposed sols have been found to be more stable towards electrolytes. It appears therefore that the particles of the sols of mastic and gum dammar become smaller on exposure to light. We are of the opinion that the exposed sols of manganese dioxide, ceric hydroxide, chromium hydroxide, zirconium hydroxide, and vanadium pentoxide are likely to show greater absorption than the unexposed sols on much longer exposure. These results are in agreement with those obtained by Svedberg with colloidal gold<sup>1</sup> and the conclusions of a previous paper from these laboratories.<sup>2</sup>

Further work on the absorption of light and the determination of the size of the particles of sols by an ultramicroscope are in progress.

<sup>1</sup> "Die Existenz der Moleküle" (1912).

<sup>2</sup> Dhar: J. Phys. Chem., 29, 1394 (1925).

### Summary

1) Coagulation experiments show that sols of ferric hydroxide, chromium hydroxide, zirconium hydroxide, ceric hydroxide prepared in the hot condition, vanadium pentoxide and manganese dioxide become less stable on exposure to light. On the other hand sols of Prussian blue, cupric ferrocyanide, mastic, and gum dammar are stabilised on exposure to light. Arsenious sulphide becomes unstable towards mono- and bivalent electrolytes but stable towards tri- and tetravalent cations. Hence sols can be divided into two classes, in one class, the stability increases and in the other the stability decreases on exposure.

2) Ceric hydroxide sols prepared in the hot and cold conditions, Odén sulphur sols prepared in excess of acid and thiosulphate, manganese dioxide sol, and the diluted sol of cupric ferrocyanide have been coagulated on exposure to sunlight.

3) The coagulation of a sol by light is due to two causes, (a) decomposition of the stabilising ion and (b) loss of reactivity of the particles of the sol. The former is possibly the more important reason.

4) The electrical conductivities of sols  $\text{Fe}(\text{OH})_3$ ,  $\text{Cr}(\text{OH})_3$ ,  $\text{Zr}(\text{OH})_4$ ,  $\text{Ce}(\text{OH})_4$  hot,  $\text{MnO}_2$ ,  $\text{As}_2\text{O}_3$ , Prussian blue, cupric ferrocyanide increase on long exposure to light whilst the specific conductivities of vanadium pentoxide, gum dammar and mastic decrease on exposure.

5) Measurements of the absorption spectra of the exposed and unexposed sols show more marked absorption of light in the cases of ferric hydroxide,  $\text{As}_2\text{S}_3$  and Prussian blue and less absorption in the cases of gum dammar and mastic. Hence it is inferred that the particles in the former class of sols agglomerate and in the latter cases, disintegrate on exposure to light.

6) In most cases the light effect is an accentuation of the time effect.

*Chemical Laboratories,  
Allahabad University,  
Allahabad, India.  
February 25, 1928.*

## A COMPARISON OF SILVER AND LEAD SOLS MADE BY THE BREDIG METHOD\*

BY HELEN QUINCY WOODARD

Considerable work has been reported on the influence of various ions in precipitating colloids. Comparatively little has been done on the influence of various ions in stabilizing colloids prepared by electrical methods, however. Hence it has seemed desirable to compare the properties of silver and lead sols prepared by the Bredig method<sup>1</sup> in different electrolyte solutions.

### Apparatus and Materials

The apparatus and materials used in the preparation of the lead colloid were the same as those previously reported.<sup>2</sup> The same apparatus and electrical connections were also used in the preparation of the colloidal silver. The silver used was Baker & Co.'s fine silver wire,  $1\frac{1}{2}$  mm. in diameter. The anode was a disk-shaped coil of this wire, the lead-in being in one piece with the disk. The cathode, from which most of the disintegration took place, was a straight piece of wire fed down with a screw feed.

### Method

The method for the lead colloid has been described in the previous paper. The method for colloidal silver was substantially the same, the current used being  $8.0 \pm 0.2$  amps D.C., and the temperature range at the level of the arc  $10^{\circ}-35^{\circ}\text{C}$ . The silver was determined by the thiocyanate method<sup>3</sup>, which gave a precision of  $\pm 0.01$  mg., the amounts determined being 0.1 mg. to 1.0 mg. All the sols, both silver and lead, were centrifuged for 5 min. with a force of  $1000 \times$  gravity, and all concentrations reported are for centrifuged sols.

### Results

When arcing was done between silver electrodes in suitable solutions, colloidal silver began to form as soon as the arc was started. The concentration of the sol rose to a maximum, and then, upon further arcing, fell to zero. Prolonged arcing in the supernatant liquid remaining after this precipitation did not result in the formation of any further colloidal silver. With some electrolytes the curve obtained by plotting the concentration of the sol against the weight of silver disintegrated in the arc per 100 cc. of sol formed showed a sharp peak; with other electrolytes the peak was more rounded.

\*From the Huntington Fund for Cancer Research, Memorial Hospital, New York City.

<sup>1</sup> Bredig: *Z. angew. Chem.*, 1898, 951.

<sup>2</sup> Woodard: *J. Am. Chem. Soc.*, 50, 1835 (1928).

<sup>3</sup> Scott: "Standard Methods of Chemical Analysis", 4th Ed., 1, 456.

This is shown in the typical curves in the accompanying figures. These curves showed good reproducibility when the time required for arcing to complete precipitation was short. With the more concentrated sols, where 1-2 hours arcing was required before the sol precipitated, it became increasingly difficult to control the steadiness of the arc, and the reproducibility fell accordingly.

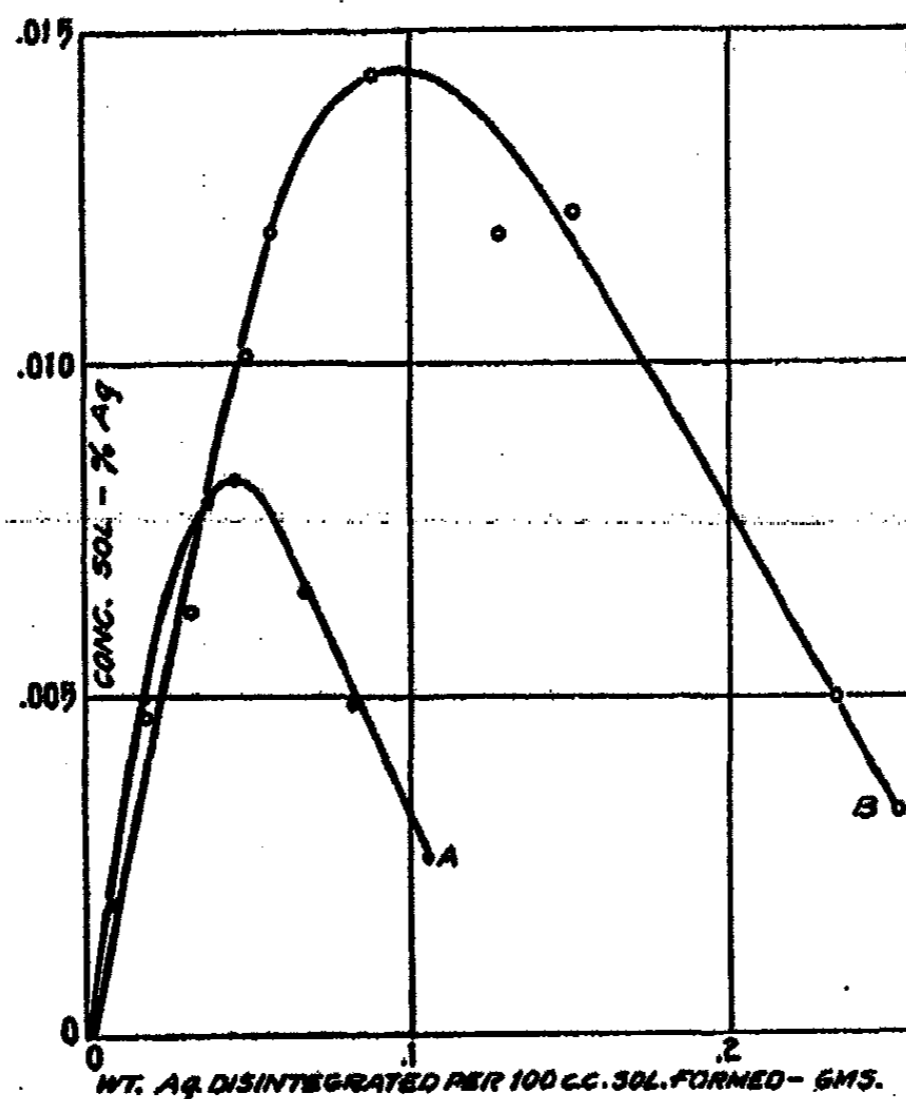

FIG. 1

Silver sols made in solutions of NaCl  
 Curve A = sols in .0014 N NaCl  
 Curve B = sols in .0025 N NaCl  
 Concentrations are for sol silver only

In the previous paper the author reported that arcing between lead electrodes resulted in the rapid rise of the concentration of the lead colloid to a maximum, and that further arcing did not result in significant change in concentration. This was considered as a fundamental difference in the process of sol formation between the lead colloid and colloidal gold<sup>1</sup>, silver<sup>2</sup>, and platinum<sup>3</sup>. Since that time over 100 lead sols made in 0.00022 N KOH under very nearly the same conditions have been available for study. When these are grouped according to the weight of lead disintegrated in the arc per 100 cc. of sol formed, there appears to be a maximum of concentration after 4-5 gms. lead have been disintegrated. (See Table I). The average

<sup>1</sup> L. W. Briggs: Diss. Columbia (1923).

<sup>2</sup> H. Q. Woodard: Diss. Columbia (1925).

<sup>3</sup> M. Baeyerts: Diss. Columbia (1924).

TABLE I  
Lead sols made in .00022 N KOH at 7.0 amps. Average concentration at different arcing periods

Pb disintegrated per 100 cc.	No. determinations	Average concentration	% deviation
0.0-0.5 gms.	9	0.031% Pb	±20%
0.5-1.0 "	13	0.074 "	±17%
1.0-1.5 "	12	0.106 "	±14%
1.5-2.0 "	12	0.146 "	±18%
2.0-3.0 "	13	0.167 "	±18%
3.0-4.0 "	21	0.169 "	±13%
4.0-5.0 "	14	0.179 "	±18%
5.0-6.0 "	14	0.163 "	±10%
6.0-7.0 "	11	0.160 "	±21%

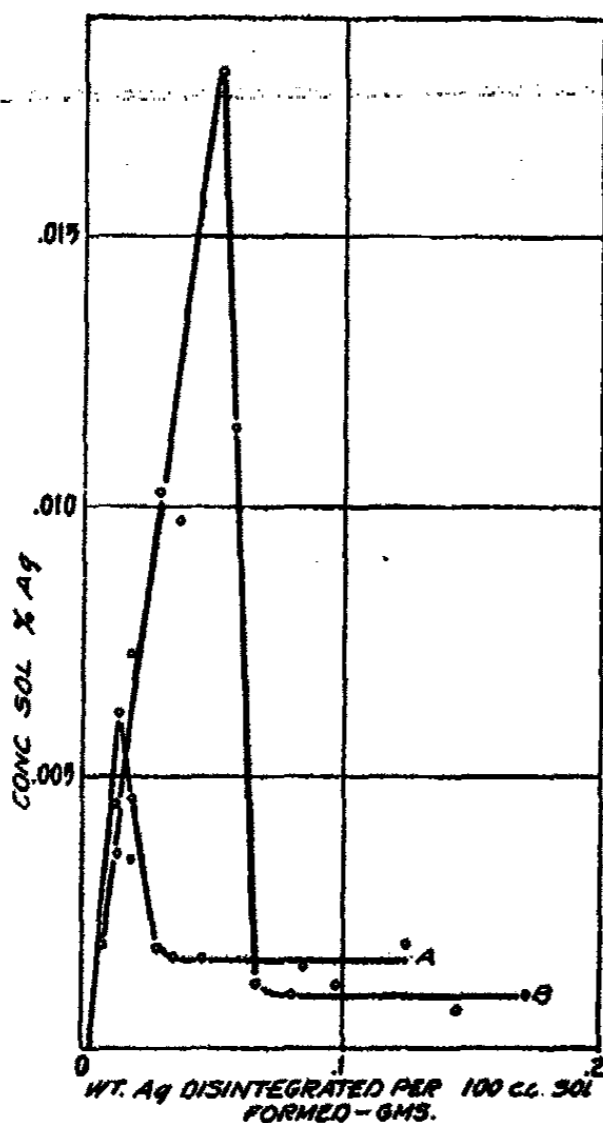

FIG. 2

Silver sols made in solutions of  $\text{Na}_2\text{S}$ .  
Curve A = sols made in .00025  $\text{NNa}_2\text{S}$ .

Curve B = sols made in .00125  $\text{NNa}_2\text{S}$ .  
Concentrations are for total silver.

deviation from the average concentrations is too large for the observations to be very significant, however. Of greater significance is a series of determinations of the concentrations of single sols made at different periods during arcing. In all sols where the arcing was continued until seven or more grams of lead had been disintegrated per 100 cc. a decrease in concentration below a previous maximum was observed, and in several sols the maximum occurred after the disintegration of 4-5 gms. per 100 cc., as in Table I. Table II gives the figures for three of these sols. It seems probable, therefore, that the formation of lead and silver sols is alike in that both colloids rise to a maximum of concentration during arcing, and then decrease upon further arcing. Owing to the technical difficulties in arcing for long periods between lead electrodes it was not determined whether it was possible to arc lead sols to complete precipitation, as can be done readily with silver sols.

Some light can be thrown on the mechanism of sol formation by studying the different behavior of sols made in different electrolyte solutions. Table III gives the results of arcing between silver electrodes in various solutions. Where the silver is reported as "total silver" 1-5 cc. samples of centrifuged sol were run into 50 cc. Erlenmeyer flasks, a few drops of concentrated nitric acid were added, the mixture was boiled until solution was complete, cooled,



and titrated against standard sodium thiocyanate. When an anion such as the chloride or thiocyanate ion, which interfered with the solution of silver in nitric acid, was used in the arcing solution, the sol was first precipitated with solid sodium nitrate and filtered. The precipitate was washed on the filter paper, dissolved in concentrated nitric acid, titrated, and reported as "sol silver." Little or no solid matter remained on the filter after this procedure, and this was taken as proof that the silver existed as metallic colloid for the most part, and not as colloidal silver chloride, thiocyanate, etc., as might be supposed. For comparison, determinations of both total silver and sol silver were made on a few sols stabilized by different concentrations of KOH and  $\text{Na}_2\text{CO}_3$ . The differences were found to be .001% Ag to .005% Ag, or about 10% of the total silver in each case.

TABLE II

Lead sols made in .00022 N KOH at 7.0 amps.

Change in concentration during arcing

Pb disintegrated per 100 cc.	Conc. sol.	Pb disintegrated per 100 cc.	Conc. sol.
0.91 gms.	0.077% Pb.	0.84 gms.	0.094% Pb.
2.32 "	0.120% "	2.28 "	0.167% "
3.73 "	0.186% "	4.29 "	0.224% "
5.93 "	0.178% "	6.40 "	0.220% "
8.33 "	0.128% "	8.90 "	0.205% "
		11.80 gms.	0.192% Pb.
1.51 gms.	0.160% Pb.		
3.43 "	0.217% "		
4.76 "	0.238% "		
6.58 "	0.223% "		
8.49 "	0.198% "		

Examination of Table III shows the following:

It was not found possible to make sols in distilled water or in solutions of silver or ammonium nitrates, and only a few transient sols of low concentration could be made in solutions of sodium nitrate and sodium acetate. It was not found possible to make sols in solutions of acetic or sulfuric acids at the concentrations tried.

Concentrated and stable sols could be made in solutions of sodium carbonate and potassium hydroxide of various concentrations.

Dilute but stable sols could be made in solutions of hydrochloric acid, sodium and ammonium chlorides, sodium thiocyanate and sodium sulfide.

It appears from the above that it is the anion in the arcing solution which determines whether a silver sol will be formed or not. This is to be expected, since colloidal silver carries a negative charge. It also appears that the effectiveness of an anion in stabilizing the colloidal silver depends on the solubility of the salt which the anion is capable of forming with ionic silver,

TABLE III  
Silver sols made at 8.0 amps in different arcing solutions

Electrolyte	Silver reported	Ag disintegrated per 100 cc.		Conc. sol at max.
		At max. conc. of sol.	At total coagulation of sol	
0.0010 N Na <sub>2</sub> CO <sub>3</sub>	Total	0.17 gms.	0.35 gms.	0.025 % Ag.
0.0019 N Na <sub>2</sub> CO <sub>3</sub>	"	0.20 "	0.35 "	0.029 "
0.0030 N Na <sub>2</sub> CO <sub>3</sub>	"	0.25 "	0.40 "	0.034 "
0.00086 N KOH	"	0.35 gms.	0.50 gms.	0.037 % Ag.
0.0013 N KOH	"	0.40 "	0.75 "	0.050 "
0.0021 N KOH	"	0.50 "	Variable	0.050 "
0.0015 N HCl	Sol	0.04 gms.	0.06 gms.	0.012 % Ag.
0.0015 N NH <sub>4</sub> Cl	"	0.10 "	0.15 "	0.012 "
0.0014 N NaCl	"	0.05 "	0.10 "	0.008 "
0.0025 N NaCl	"	0.10 "	0.23 "	0.014 "
0.0050 N NaCl	"	0.23 "	0.40 "	0.033 "
H <sub>2</sub> O No sols formed.				
0.0015 N NaCNS	Sol	0.07 gms.	0.08 gms.	0.008 % Ag.
0.00025 N Na <sub>2</sub> S*	Total	0.015 gms.	0.03 gms.	0.006 % Ag.
0.00075 N Na <sub>2</sub> S	"	0.03 "	0.05 "	0.011 "
0.00125 N Na <sub>2</sub> S	"	0.05 "	0.06 "	0.018 "
0.0025 N Na <sub>2</sub> S	"	0.09 "	0.10 "	0.028 "
0.00055 N AgNO <sub>3</sub> to 0.0026 N AgNO <sub>3</sub>	Total	No sols formed.		
0.0005 N NaNO <sub>3</sub>		0.015 gms.	0.02 gms.	0.0045 % Ag.
0.0014 N NaNO <sub>3</sub>		0.015 "	0.02 "	0.0045 "
0.0025 N NaNO <sub>3</sub>	"	0.010 "	0.02 "	0.0040 "
0.0014 N NH <sub>4</sub> NO <sub>3</sub>	No sols formed.			
0.0015 N CH <sub>3</sub> COONa	Trace sol Ag at 0.01 gms. disintegrated per 100 cc.			
0.0013 N CH <sub>3</sub> COOH	No sols formed.			
0.0015 N H <sub>2</sub> SO <sub>4</sub>	No sols formed.			

\*Concentrations of Na<sub>2</sub>S given are with respect to the S content. Owing to hydrolysis, the Na content was about 20% higher.

the anions capable of forming moderately insoluble compounds with silver being the most effective. Thus the nitrate, sulfate, and acetate of silver are readily soluble salts, and the acetates, nitrates (with the doubtful exceptions mentioned above) and sulfuric acid were not found capable of stabilizing silver sols. Silver carbonate and hydroxide are moderately insoluble, and sodium carbonate and potassium hydroxide were found to be good stabilizing agents for colloidal silver. Silver chloride, sulfide, and thiocyanate are highly insoluble salts, and the chloride, sulfide, and thiocyanate solutions tried were found to be only fair stabilizing agents. That the formation of

the colloid is influenced to a certain extent by the cation as well as the anion is shown by the differences in concentration and range between sols prepared in equinormal concentrations of ammonium chloride, sodium chloride, and hydrochloric acid, but the influence of the cation appears small compared to that of the anion.

Since it is the anion of the arcing solution which has the most influence on the formation of silver sols, which carry a negative charge, one would expect, as lead sols carry a positive charge, that the cation would be the important ion in the solution used for the preparation of lead sols. Table IV, which has been published in part previously<sup>1</sup> shows this to be so. The concentrations of lead sols given are those in the "plateau" of the concentration curve, when the concentration is changing only very slowly as arcing proceeds. All sols were prepared with a current of 1.4 amps in approximately equinormal solutions of different electrolytes.

TABLE IV  
Lead sols made at 1.4 amps in different arcing solutions

Electrolyte	Av. conc. sol.	No. determinations	% deviation from av.
0.00025 N H <sub>2</sub> SO <sub>4</sub>	0.039% Pb	5	±19
0.00025 N HCl	0.038 "	15	±20
0.00025 N lactic acid	0.044 "	8	±20
0.00022 N CH <sub>3</sub> COOH	0.050 "	6	±24
0.00025 N NH <sub>4</sub> Cl	0.035 "	9	±28
0.00025 N NH <sub>4</sub> NO <sub>3</sub>	0.038 "	10	±21
0.00025 N NaCl	0.100 "	6	± 8
0.00025 N NaNO <sub>3</sub>	0.113 "	8	±11
0.00025 N CH <sub>3</sub> COONa	0.124 "	7	± 9
*0.00029 N Na <sub>2</sub> S	0.102 "	7	±17
0.00025 N Na <sub>2</sub> CO <sub>3</sub>	0.098 "	5	±13
0.00022 N KOH	0.122 "	63	±15
0.00025 N NaHCO <sub>3</sub>	0.083 "	5	±17

\* Concentration of Na<sub>2</sub>S given is with respect to the Na content. Owing to hydrolysis, the S content was about 15% lower.

It was previously reported that, for most of the solutions examined, "the concentration of colloidal lead stabilized by equinormal concentrations<sup>1</sup> of different electrolytes is a function of the pH of the initial solution." This is confirmed in the larger series presented here when hydrogen is the preponderating cation in the initial solution. It appears from an examination of the table that hydrogen and ammonium are poor stabilizing agents, 0.00025 N solutions of hydrochloric and sulfuric acids, ammonium chloride and ammonium nitrate, being able to stabilize sols containing only 0.035-0.039% lead. On the other hand, sodium and potassium appeared to be

<sup>1</sup> H. Q. Woodard: J. Am. Chem. Soc., 50, 1835 (1928).

much more effective stabilizing agents, sodium chloride, nitrate, acetate, sulfide and carbonate, and potassium hydroxide, in approximately equinormal concentrations, being able to stabilize sols containing 0.10-0.12% lead. Lactic and acetic acids and sodium hydrogen carbonate occupied intermediate positions between the strong acids and ammonium salts on the one hand, and the sodium and potassium compounds on the other.

As with silver sols, it is probable that the formation of lead sols is influenced somewhat by the ion of opposite charge to that of the sol formed. This is suggested by the differences in concentration between the sols stabilized by different sodium salts. The reproducibility of these sols is not sufficiently good for positive statements on this question, however.

Among the positive ions which may be present in the initial solution, lead itself must also be considered. When the hot arcing solutions are cooled in contact with the electrodes, lead dissolves up to a concentration which varies with the state of the electrodes, rapidity of cooling, solution used, and probably other factors. The concentrations average somewhat higher when solutions of acids or ammonium salts are used than with most of the sodium salts, and are still lower for sodium carbonate and bicarbonate and potassium hydroxide, the average values being in the neighborhood of 0.0002 N Pb, 0.00015 N Pb, and 0.00010 N Pb, respectively. As, owing to the amphoteric properties of lead, it is not certain how much of the lead present in these solutions is in the anion and how much in the cation, it can not be considered unreservedly as one of the stabilizing cations. A thorough study of the effectiveness in stabilizing lead sols of mixtures of salts of lead with salts of other metals would be necessary before the influence of lead ion could be evaluated.

#### Summary

A comparison has been made of the changes in Bredig silver sols and Bredig lead sols on prolonged arcing.

The formation of Bredig silver sols has been found to be determined mainly by the negative ion in the arcing solution.

The formation of Bredig lead sols has been found to be determined mainly by the positive ion in the arcing solution.

## ON THE RAMAN EFFECT IN LIQUID PYRIDINE

BY S. VENKATESWARAN

### 1. Introduction

In a recent paper Prof. Raman<sup>1</sup> announced the discovery of a new type of secondary radiation which is of fundamental importance in Physical Chemistry. He has found that when monochromatic light is diffused through a transparent medium, the scattered radiation ceases to be monochromatic, and several new lines and sometimes bands also, appear in the spectrum of the scattered light. This phenomenon, is, however, entirely different from what is usually known as fluorescence since the scattered radiations are in general strongly polarised and also since the effect is observed even when both the exciting and the excited radiations are far removed from the characteristic ultraviolet and infra-red frequencies of the molecule. According to Prof. Raman this new radiation arises from the fact that the incident quantum of radiation is partly absorbed by the molecule, shifting it to higher level of energy, the remaining part appearing as the scattered radiation. The difference in frequency between the incident and scattered radiations would thus correspond to the characteristic infra-red frequency of the molecule. The universality of this phenomenon was emphasized by Prof. Raman who showed that the effect was observed not only in the case of vapours and liquids but also in crystals and amorphous solids, a block of crystalline ice, for example, showing the shifted lines in the scattered spectrum in approximately the same positions as liquid water. Detailed studies of this new radiation have been made by Raman and Krishnan<sup>2</sup> in water, benzene, toluene, pentane, methyl alcohol, ether, and carbon tetrachloride, by Cabannes and Daure<sup>3</sup> in benzene, by Daure<sup>4</sup> in ether, alcohol, benzene, and toluene and by the present author in glycerine and glycerine-water mixtures.<sup>5</sup> With a view to finding the relationship between chemical constitution and the scattered spectra the author intends to study the Raman effect in a large number of liquids. The present paper deals with the study of this effect in pyridine.

### 2. Experimental Details

The experimental methods were similar to those mentioned by Raman and Krishnan and by the author in their recent papers. Merck's extra pure pyridine was taken for the purpose and was rendered dust-free in a

<sup>1</sup> "A New Radiation" by C. V. Raman: *Ind. J. Phys.*, 2, 387 (1928). See also C. V. Raman and K. S. Krishnan: *Nature*, 121, 501 (1928).

<sup>2</sup> C. V. Raman and K. S. Krishnan: *Ind. J. Phys.*, 2, Part IV, 399 (1928).

<sup>3</sup> Cabannes and P. Daure: *Compt. rend.*, 186, 1533 (1928).

<sup>4</sup> P. Daure: *Compt. rend.*, 186, 1833 (1928).

<sup>5</sup> S. Venkateswaran: *Ind. J. Phys.*, 3, Part I (1928).

large double-bulb by repeated distillation in vacuo. The bulb containing the final distillate was immersed in a suitably blackened glass tank containing water and light from a 3000 c.p. mercury arc lamp was condensed into the liquid with an eight inch condenser. The spectrum of the scattered light was photographed with a Hilger E<sub>2</sub> quartz spectrograph using Ilford Isozenith plates (H & D 700). The wave lengths of the lines appearing in this spectrogram were calculated from the micrometer measurements using the mercury arc lines as the standard. Simplified Hartmann interpolation formula was used.

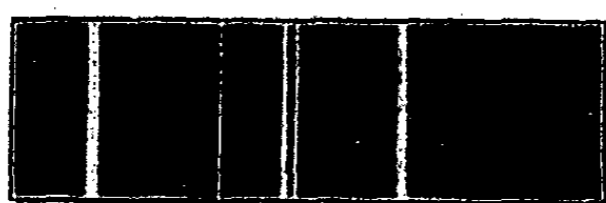

FIG. 1  
Incident Spectrum



FIG. 2  
Scattering Spectrum



FIG. 3  
Incident  
(4358.3 A. U. group)



FIG. 4  
Polarisation of Scattering  
in Pyridine

A strong fresh solution of quinine sulphate followed by a blue-glass filter cuts off practically all radiations except the 4358.2 A.N. group from the mercury spectrum. A spectrogram was taken keeping these filters in the path of the incident light. As the quinine sulphate solution gets coloured owing to the action of the ultra-violet radiations, it was replaced with a freshly prepared solution every 24 hours. This spectrogram (not reproduced in this paper) was used for the identification of the modified lines.

### Results

The spectrograms are reproduced in Figs. 1-4. The spectrum of the full light of the mercury arc is given in Fig. 1 and the corresponding spectrum of pyridine scattering is given in Fig. 2. Fig. 3 represents the spectrum of the incident light filtered through the quinine sulphate solution and the blue glass. The spectrograms reproduced in Fig. 4 were taken for studying the polarisation of the modified lines generated by the incident light thus filtered (4358.3 Å.U. group).

TABLE I  
Spectrum of Pyridine-Scattering

Unmodified lines			Modified lines			Origin of the modified lines	
Wave length in Å. U.	Wave number (in vacuo per cm.)	Intensity	Wave length in Å. U.	Wave number (in vacuo per cm.)	Intensity	Exciting lines in Å. U.	Difference in wave numbers
3341.5	29918	1					
3543.4	28213	3					
3561.7	28068	3					
3579.7	27927	0					
3593.0	27824	1					
	band						
3615.8	27649	1					
3650.1	27389	100					
3654.8	27354	30					
3663.3	27290	30					
3680.0	27166	3					
3704.3	26988	6					
			3732.4	26785	1/2	3650.1	604
			3738.7	26739	1	3650.1	650
			3744.2	26700	0	3654.8	654
3751.7	26647	5					
2771.0	26511	3					
			A modified line coincides with this incident line			3650.1	878
			3786.5	26402	7	3650.1	987
			3791.6	26366	7	{ 3650.1 3654.8 }	{ 1023 988 }
3789.8	26379	10					
3801.7	26297	6					
			3797.2	26327	1	3654.8	1027
			A modified line coincides with this incident line			3663.3	993
			3806.5	26263	2	3663.3	1027
3820.4	26168	5					
			A modified line coincides with this incident line			3650.1	1221
			3825.2	26135	1/2	3654.8	1219
			3834.1	26074	1	3663.3	1216
			3842.4	26018	0		
3860.3	25897	5					
			3872.7	25814	2	3650.1	1575
			3878.0	25779	1	3654.8	1575
			3887.6	25715	0	3663.3	1575
3895.3	25665	2					
3902.0	25621	6					
3906.5	25591	20					
3984.0	25093	8					

## Spectrum of Pyridine-Scattering

Unmodified lines			Modified lines			Origin of the modified lines	
Wave length in Å. U.	Wave number (in vacuo per cm)	Intensity	Wave length in Å. U.	Wave number (in vacuo per cm)	Intensity	Exciting lines in Å. U.	Difference in wave numbers
			4008.3	24941	0	3906.5	650
4046.6	24705	100					
4077.6	24516	30					
4108.9	24331	10					
			A modified line coincides with this line			3650.1	3058
			4115.0	24925	2	3654.8	3059
			4124.9	24236	5	3663.3	3059
					broad		
			4139.4	24154	1		
			4147.9	24102	1	4046.6	603
			4156.2	24054	2	4046.6	651
			4197.2	23319	1	4046.6	886
			4215.3	23716	10	4046.6	989
			4222.6	23675	10	4046.6	1028
			4249.1	23528	2	4077.6	988
			4256.4	23487		{4046.6 4077.6}	{1218 1019}
			4290.4	23301	1/2	4077.6	1215
4313.5	23177	1					
			4321.9	23131	1	4046.6	1574
4339.2	23039	15					
4347.5	22995	30					
4358.3	22938	200					
			P.J.O.				
			4436.7	22533	1/2	3906.5	3058
			4476.0	22335	1/2	4358.3	603
			4485.5	22288	1	4358.3	650
			4533.1	22053	1/2	{4339.2 4358.3}	{986 885}
			4543.1	22005	1/2	4347.5	990
			4554.4	21950	10	4358.3	988
			4563.0	21909	10	4358.3	1029
			4589.8	21781	1	4347.5	1214
			4603.1	21718	2	4358.3	1220
			4617.1	21652	10	4046.6	3053
					broad		
			4658.3	21416	4	4077.6	3055
			4680.7	21358	4	4358.3	1580
4916.1	20336	1					
			5027.3	19885	3	4358.3	3053
5460.7	18307	1/2					



Table I shows the wave lengths of the incident and modified lines and their wave numbers obtained from Kayser's "Tabelle der Schwingungszahlen." An analysis of the data given in this table is given in Table II. Against each exciting line the shifts in wave numbers between it and the modified lines generated by it are given.

TABLE II  
Analysis of the modified lines in Pyridine-Scattering

Incident line in Å. U.	Shift of wave number of the modified lines							
3650.1	604	650	878	987	1024	1221	1575	3058
3654.8		654		988	1027	1219	1575	3059
3663.3				988	1027	1216	1575	3054
3906.5		650						3058
4046.6	603	651	886	989	1028	1218	1574	3053
4077.6				988	1029	1215		3055
4358.3	603	650	885	988	1029	1220	1580	3053
4339.2				986				
4347.5				990		1214		
Mean shift of wave number	603	651	883	988	1027	1217	1576	3056

#### 4. Discussion of Results

The most striking feature of the spectrogram of pyridine scattering (See Fig. 2) is the presence in it of a large number of new lines, superlaid with a faint continuous spectrum, not present in the incident light. The following general features may also be noted.

1). Each incident line generates a group of modified lines corresponding to the different natural frequencies of the molecule. This is seen from Table III where the shifts in wave numbers between any one incident line and its corresponding modified lines are the same for each exciting line.

2). The relative intensities of the different lines within each group of modified lines appears to be the same and are therefore independent of the frequency of the exciting line. Thus the modified lines corresponding to the shifts of wave numbers of 988, 1027, 1580 and 3056 are the brightest in each group.

*Nebulosity:* Accompanying each of the intense lines there is a certain amount of continuous spectrum or broadening of the line similar to that observed and photographed by Raman and Krishnan in the case of benzene. In their recent paper communicated to the Royal Society, these authors have, however, introduced a more appropriate term "Nebulosity" to describe this phenomenon. The nebulosity in pyridine scattering is conspicuously seen accompanying the prominent lines in the spectrogram reproduced in this paper. An examination of the spectrograms representing the incident light and the scattered radiations shows that the effect is genuine and is not due to simple halation in the photographic plate.

### 5. Infra-Red Absorption Spectrum of Pyridine

As has already been mentioned, the shifts in frequency between the incident and modified radiations due to Raman effect correspond to the characteristic infra-red frequencies of the molecule. An excellent method is thus offered of photographing and studying the infra-red spectrum of liquids and other transparent media to a far greater degree of accuracy than could be obtained by other methods, such as reflection measurements etc. The following table gives the values thus obtained for the infra-red frequencies of pyridine and their corresponding wave lengths. No work appears to have been done so far on the infra-red adsorption of pyridine.

Shift of wave number	603	651	883	988	1027	1217	1576	3056
wave length in $\mu$	16.58	15.36	11.32	10.12	9.735	8.214	6.343	3.271
relative intensities of the corresponding modified lines	1	2	1	10	10	1	3	5

### 6. Polarization of the Modified Radiations

The polarisation of the modified lines was studied spectroscopically by taking two spectrograms side by side with equal exposures and under identical conditions, using a large nicol in front of the spectrograph. During the first exposure the shorter axis of the nicol was perpendicular to the track and during the second parallel to the track. Only the 4358.3 Å.U group of lines was used as the incident radiation. The spectrograms are reproduced as Figs. 3 and 4. An examination of the spectrograms shows that in addition to all the unmodified lines (classical scattering), all the modified lines, and also the continuous spectrum are strongly polarised, but the degree of polarisation is different for the different lines. The most intense lines due to the shifts in wave numbers 988 and 1027 are also the most strongly polarised, while the other modified lines are much less polarised. The importance of this result with reference to the structure of pyridine will be discussed in the next section.

The observation regarding the polarisation of the modified lines is of great theoretical importance. Based on the ideas of classical light scattering Raman and Krishnan have offered an explanation for the observed imperfection of polarisation of the modified lines. They suggest that for a given energy transition of the molecule there are three principal directions in the molecule and that the Einstein coefficients of probability of transition under the influence of an external force incident respectively along the three directions are different.

### 7. Comparison with Benzene

The structure of benzene has always been one of the most fascinating problems in chemistry. Considerable new light has been thrown on this subject in recent years by X-ray studies. Chemical evidence such as the formation of

mellitic acid and other aromatic compounds from graphite suggests that the structure of benzene is similar to that of graphite. Bernal<sup>1</sup> has shown from X-ray analysis that the atoms of carbon in graphite lie in planes in which they form nets of hexagons. In a recent paper Pauling<sup>2</sup> has discussed this question and has proposed an electronic structure of the benzene molecule in which all the six carbon atoms and the six hydrogen atoms lie in the same plane at the corners of two concentric regular hexagons. This structure is supported by X-ray and other evidence.

The great similarity of pyridine and benzene in chemical behaviour, such as its stability, the formation of hexahydrate and the existence of three mono-substitution derivatives, suggests that the two have similar structure. The various formulae suggested by Korner, Riedel and Bamberger are all similar to those suggested for benzene. The arrangement of the different atoms of the pyridine molecule in space is not yet definitely known. A comparison of the Raman effect in the two liquids appears, however, to throw some light on this problem. From the following table which shows the characteristic infra-red wave lengths of pyridine and benzene it will be found that several of them have almost identical values.

**Pyridine**

wave length in  $\mu$

16.58 15.36 11.32 10.12 9.735 8.214 6.343 3.271

relative intensities of  
the modified lines

1 2 1 10 10 1 3 5

**Benzene**

wave length in  $\mu$

16.50 11.78 10.10 8.51 6.28 3.268

relative intensities  
of the modified lines

2 0 15 2 1 4

The two prominent values 3.268 and 10.10 for benzene can certainly be identified with the values 3.271 and 10.12 in pyridine. The wave lengths 16.50 and 6.28 which however correspond to relatively feebler scattered lines also appear in both.

The similarities are even more striking on making a comparative study of the polarization of the modified lines. Raman and Krishnan and Cabannes have studied the polarisation of the modified lines in benzene. It is found that the degree of polarisation of the corresponding modified lines in benzene and pyridine is nearly the same. For instance, the modified line corresponding to 10.12  $\mu$  is the most intense and also the most strongly polarised in the two

<sup>1</sup> Bernal: Proc. Roy. Soc., 106 A, 749 (1924).

<sup>2</sup> L. Pauling: J. Am. Chem. Soc., 48, 1332 (1926).

liquids. The correspondence in the degree of polarisation of the different modified lines which appear in the scattered spectra of both pyridine and benzene suggests that the nuclear vibrations to which these lines correspond are identical in both cases. This means that the replacement of a CH group by N does not influence to an appreciable extent either the frequencies or the directions of vibrations of the other atoms. Thus the facts of light scattering point clearly a much closer resemblance between the pyridine and benzene molecules than is suggested by the usual chemical evidence.

It is also found that the pyridine molecule has in addition to those of benzene, two new characteristic frequencies, of which the one corresponding to  $9.73 \mu$  is the most conspicuous. This additional prominent line appears to be generated by the substitution of nitrogen in place of the C.H. group. It is nearly as intense as the  $10.12 \mu$  line and is polarised also to nearly the same extent. These suggest a common origin for these two prominent modified lines. More data are, however, necessary before any correlation can be made between the infra-red frequencies and the oscillations of the carbon-nitrogen bond, on the lines suggested by Ellis and others. Bates and Andrews<sup>1</sup> identify the wave lengths  $3.3 \mu$  and  $9.9 \mu$  respectively with the oscillations of the hydrogen carbon bond and the carbon-carbon bond. This explains the observed larger intensity of the two modified lines corresponding to  $3.271 \mu$  and  $10.12 \mu$ .

#### Summary

1. The paper gives the results of the study of the Raman effect in pyridine using the light from a mercury arc lamp as the incident source. The spectrum of the scattered light shows the presence of several modified lines and a faint continuous spectrum. The wave lengths of all the modified lines have been measured and their wave numbers are given.

2. The shifts in wave numbers between the incident and modified radiations which correspond to the characteristic frequencies of the molecule have been calculated. The corresponding infra-red emission wave length of the pyridine molecule are of  $16.58 \mu$ ,  $15.36 \mu$ ,  $11.32 \mu$ ,  $10.12 \mu$ ,  $9.735 \mu$ ,  $8.214 \mu$ ,  $6.343 \mu$ , and  $3.271 \mu$ .

3. The polarisation of the modified lines has been studied spectroscopically and it is shown that the different modified lines are differently polarised. The two most prominent lines corresponding to  $10.12 \mu$  and  $9.735 \mu$  are also the most strongly polarised.

4. From a comparison of the Raman effect in benzene and pyridine it is suggested that the two have similar structure.

In conclusion I wish to thank most heartily Prof. C. V. Raman, under whose inspiring guidance the work was carried out and my friend Mr. K. S. Krishnan for valuable suggestions and help.

210, Bowbazar St., Calcutta,  
September 1, 1928.

<sup>1</sup> J. R. Bates and D. H. Andrews: Proc. Nat. Acad. Sci., 14, 128 (1928).

CHEMICAL ACTION IN THE GLOW DISCHARGE II.\*  
 FURTHER INVESTIGATION ON THE  
 SYNTHESIS OF AMMONIA

19-8

A. KEITH BREWER AND J. W. WESTHAVER

In a recent article<sup>1</sup> certain factors were presented governing the synthesis of ammonia from a  $3\text{H}_2\text{-N}_2$  mixture in various types of glow discharge tubes. The novel thing noted in these experiments was that, when the back reaction was removed by freezing out the ammonia as fast as formed with liquid air, the rate of synthesis was completely independent of pressure. The results obtained suggested an electrochemical equivalence law for discharge tubes which may be stated: *for a given set of operating conditions the rate of synthesis is independent of the pressure and depends only on the current passing through the tube.* This may be expressed as  $dP/dt = \alpha I$ , where  $P$  is defined as the equivalent ammonia pressure,  $I$  is the current, and  $\alpha$  depends on the conditions of the experiment.

It is the purpose of the present paper to treat the various factors influencing  $\alpha$ , and to present further evidence regarding the reaction mechanism. Special attention will be given to the region of the discharge wherein the synthesis takes place, and to the effect of gases added to the  $3\text{H}_2\text{-N}_2$  mixture.

**Discharge Tubes**

Two general types of discharge tubes were used in these researches. Fig. 1 shows the tube used to test the effect of added gases on the rate of synthesis. The discharge chamber and directly-connected balloon flask constituted 80% of the volume of the entire static system. Diffusion as well as convection currents set up in the discharge prevented the accumulation of added gases around the electrodes, so the composition of the gas throughout the system at any one instant was practically uniform. Electrodes A and B were used in cracking the ammonia to produce the  $3\text{H}_2\text{-N}_2$  mixture, while electrodes C and D were used for synthesis.

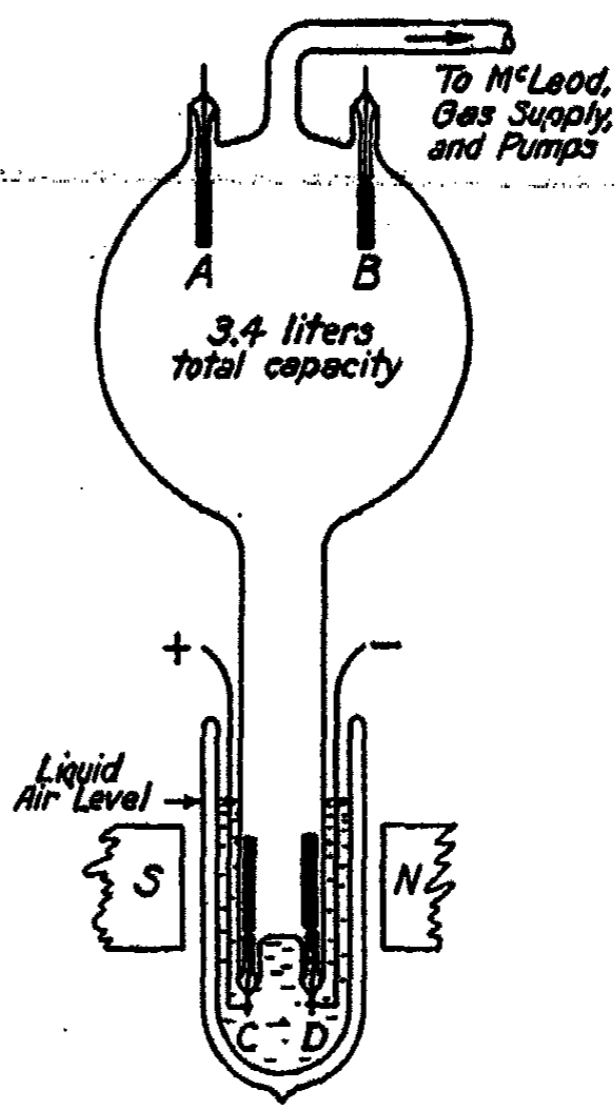

FIG. 1  
 Discharge Tube permitting Diffusion  
 of Gases

\* Fertilizer and Fixed Nitrogen Investigations, Bureau of Chemistry and Soils, Washington, D. C.

<sup>1</sup>Brewer and Westhaver: J. Phys. Chem., 33, 883 (1929).

The type of discharge tube used to test the relative reactivity of various portions of the discharge is illustrated in Fig. 2. The tube was 2 cm. in diameter and 70 cm. long; a special Dewar flask enabled the tube to be immersed to a depth of 60cm. Exploring electrodes were placed at suitable positions along the barrel of the tube.

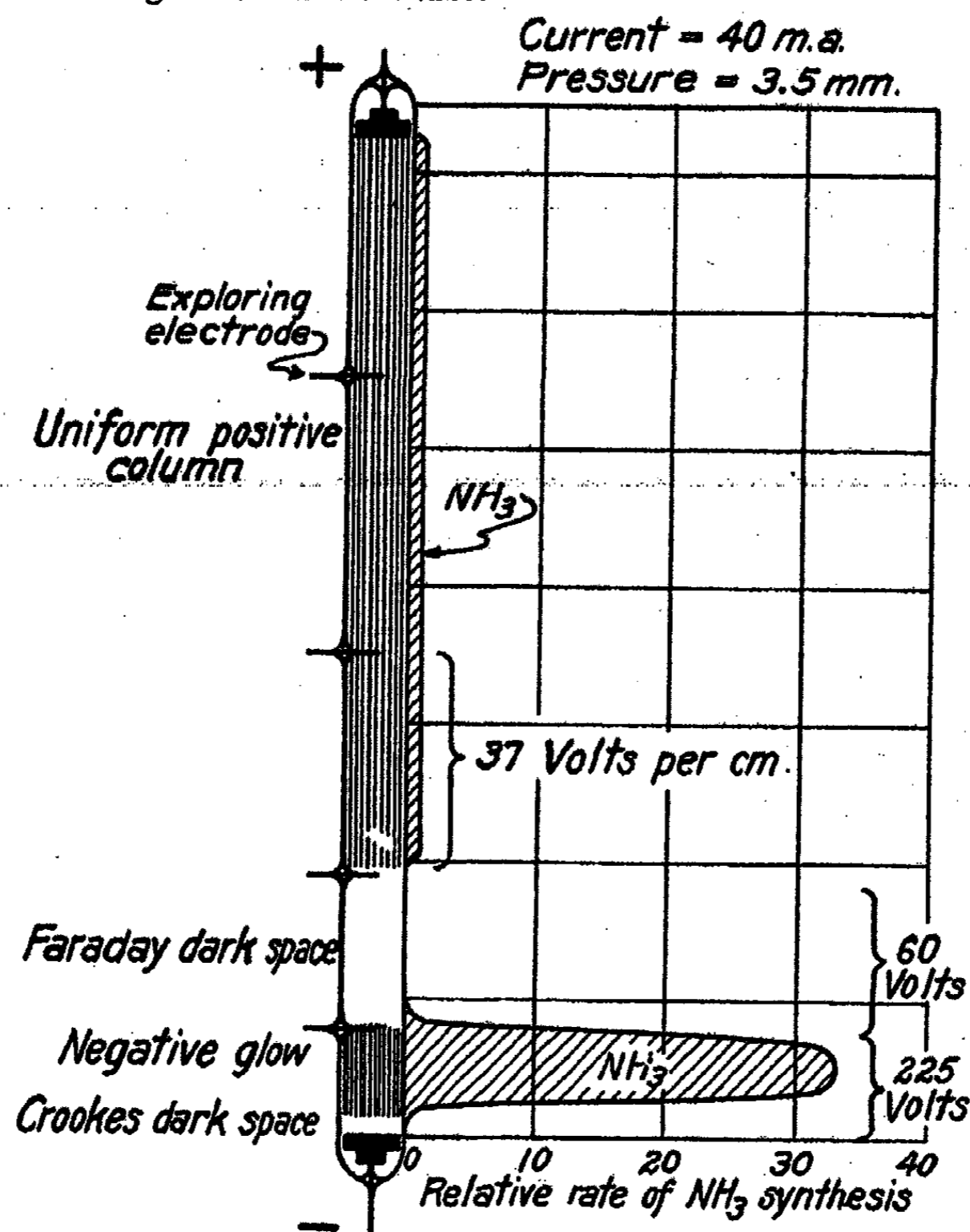

FIG. 2

Distribution of NH<sub>3</sub> in Geissler Discharge

The method of procedure employed was identical with that described in the previous communication. Direct current from a rotary converter was substituted for the alternating current previously used.

#### Factors influencing $\alpha$

In the following discussion, the various factors that influence the rate constant  $\alpha$  will be considered separately.

(1) *Effect of Pressure.* The most important property of the constant  $\alpha$  is its independence of pressure. This was shown in the previous paper to be the case over wide ranges of pressure, both for the positive column and the

regions surrounding the electrodes. Had it not been for this one fact, a comprehensive study of the reaction would have been impossible, since little information could be obtained of the actual gas concentration within the discharge under any such varying conditions as were present in this work.

(2) *Effect of Temperature.* Since the energy supplied at constant current to the discharge changes with pressure, the gas doubtless suffers considerable variation in temperature. As pointed out above, the rate of reaction was found to be constant, and hence the effect of temperature appears to be negligible. Tubes in which the electrodes were cooled by immersing in liquid air gave practically the same value for  $\alpha$  as did similar tubes with uncooled electrodes which often became heated to the melting point of aluminum.

(3) *Magnetic Fields.* Data showing the effect of magnetic fields on the value of  $\alpha$  have been presented in the previous paper. In Fig. 3 of the first paper it will be seen that a magnetic field parallel to the electric field has no effect on the value of  $\alpha$ , while a magnetic field placed at right angles, materially increases its value.

The magnetic field when placed parallel to the electric field enabled the synthesis in tubes of the type illustrated in Fig. 1 to be carried on at a much lower pressure than was possible otherwise. A properly adjusted tube of this type gives with direct current a straight line time-pressure curve from 4.2 mm. to about 0.1 mm. pressure, as is shown by line 1 of Fig. 3. The particular function of the magnetic field in this case is to confine the discharge to such a thin sheet that the amount of ammonia decomposed by electron bombardment of the walls is inappreciable.

(4) *Electrostatic Fields.* It was pointed out in the previous paper that various electrostatic fields applied at right angles to the path of the discharge had no effect on the rate of synthesis.

(5) *Portion of Discharge where Synthesis takes Place.* The reaction efficiencies for various portions of the discharge in a  $3\text{H}_2\text{-N}_2$  mixture are represented graphically in Fig. 2. Relative reaction rates are plotted against the centimeter length of the tube. The cross-hatched areas represent the relative amounts of ammonia formed in the different portions of the tube. The actual reaction rates were measured for several depths of immersion, and from these data the relative amounts of ammonia frozen out on the walls were calculated. The time-pressure curves from which the rates were obtained were straight lines. A qualitative estimate of the reactivity throughout the tube was made by a direct observation of the distribution of ammonia frozen out on the walls. The white films of ammonia were quite sharply defined, showing little evidence of diffusion from the uncooled portions of the tube.

It will be seen from the graph that appreciable synthesis takes place only in the glowing parts of the discharge. Maximum synthesis was found to occur in the negative glow, while no synthesis was noted in the Crookes and Faraday dark spaces. The positive column, including the anode glow, produced a uniform synthesis throughout its length. Under special conditions, however, striated deposits have been observed in the positive column, in-

dicating that each striation with its following dark space behaves much the same as the negative glow and Faraday dark space.

The potential distribution along the tube was measured by means of exploring electrodes connected to a specially designed electrostatic voltmeter. This distribution of potential was found to vary with changes in pressure and current. The voltage drops shown on the graph were measured at 3.5 mm. pressure and 40 mm. current. The rate of synthesis in the negative glow was 33 times that in a unit length of positive column, and the ratio of voltage drops for the above values of current and pressure was 225/37.

The rate per unit of power input under these conditions is  $33 \times 37/225$  or 5.4 times as great for the negative glow as for the positive column. At a pressure of 1 mm. the power efficiencies of the two regions are nearly equal due to an increase in the cathode fall of potential and a decrease of the potential gradient in the positive column. Below 1 mm. pressure the power efficiency favors the positive column. Although the power input to the two regions changes with pressure, the rate of synthesis for both remains constant provided the current is unchanged.

For the positive column the value of  $\alpha$ , which may be termed the current efficiency, is proportional to the length of the tube immersed; the power efficiency, however, due to the uniform potential gradient, is independent of the length of tube immersed. In the positive column the value of  $\alpha$  is smaller for tubes of small bore. In the negative glow  $\alpha$  varies but slightly with the size of the cathode; such variations as were noted could be attributed to effects produced by the proximity of the glass walls to the electrode. For seven tubes in which the negative glow alone was responsible for the synthesis, the mean value of  $\alpha$  was found to be .74 molecules per electron of current.

(6) *Effect of Added Gases.* The effect of various gases on the rate of synthesis when added in different proportions to the  $3\text{H}_2\text{-N}_2$  mixture is illustrated in Figs. 3-5.

Fig. 3 shows a set of time-pressure curves obtained from a series of runs in which nitrogen was in excess of that necessary for a  $3\text{H}_2\text{-N}_2$  ratio. Similar series of curves were obtained in which hydrogen, argon and helium were added to the combining mixture.

Line 1 shows the time-pressure relationship obtained for the  $3\text{H}_2\text{-N}_2$  mixture. It will be seen that the rate of synthesis as given by the slope of the line is unchanged from 4.2 mm. to 0.2 mm. The slowing down of the rate at the low pressures, as pointed out in the previous paper, is due largely if not entirely to the removal of ammonia from the walls by electronic bombardment, and possibly by radiation. The other lines in Fig. 3 represent the effect of various quantities of added nitrogen on the rate of synthesis. Line 2 is interesting in that it first shows a speeding up of the reaction rate as the percent of nitrogen increases and, then a slowing down as the percent of nitrogen passes that for maximum rate.

When the curves were plotted on a large scale it was seen that only line 1 was straight, the rest curving to a degree depending on the excess nitrogen



present. Similar curved lines were obtained for excess hydrogen, helium and argon. From this it will be seen that *the rate of reaction is independent of pressure as long as the composition of the gas remains unchanged*. The effect of helium is less marked than that of the other gases.

The variation in  $\alpha$  with change of composition is plotted in Figs. 4 and 5. The rates plotted were taken from the time-pressure curves at 3.5 mm. Since the lines obtained with added gases become slightly curved with increasing added gas content, the slope of the tangent to the curve at 3.5 mm. was taken as a convenient measure of the rate, and the composition of the gas at this pressure was calculated.

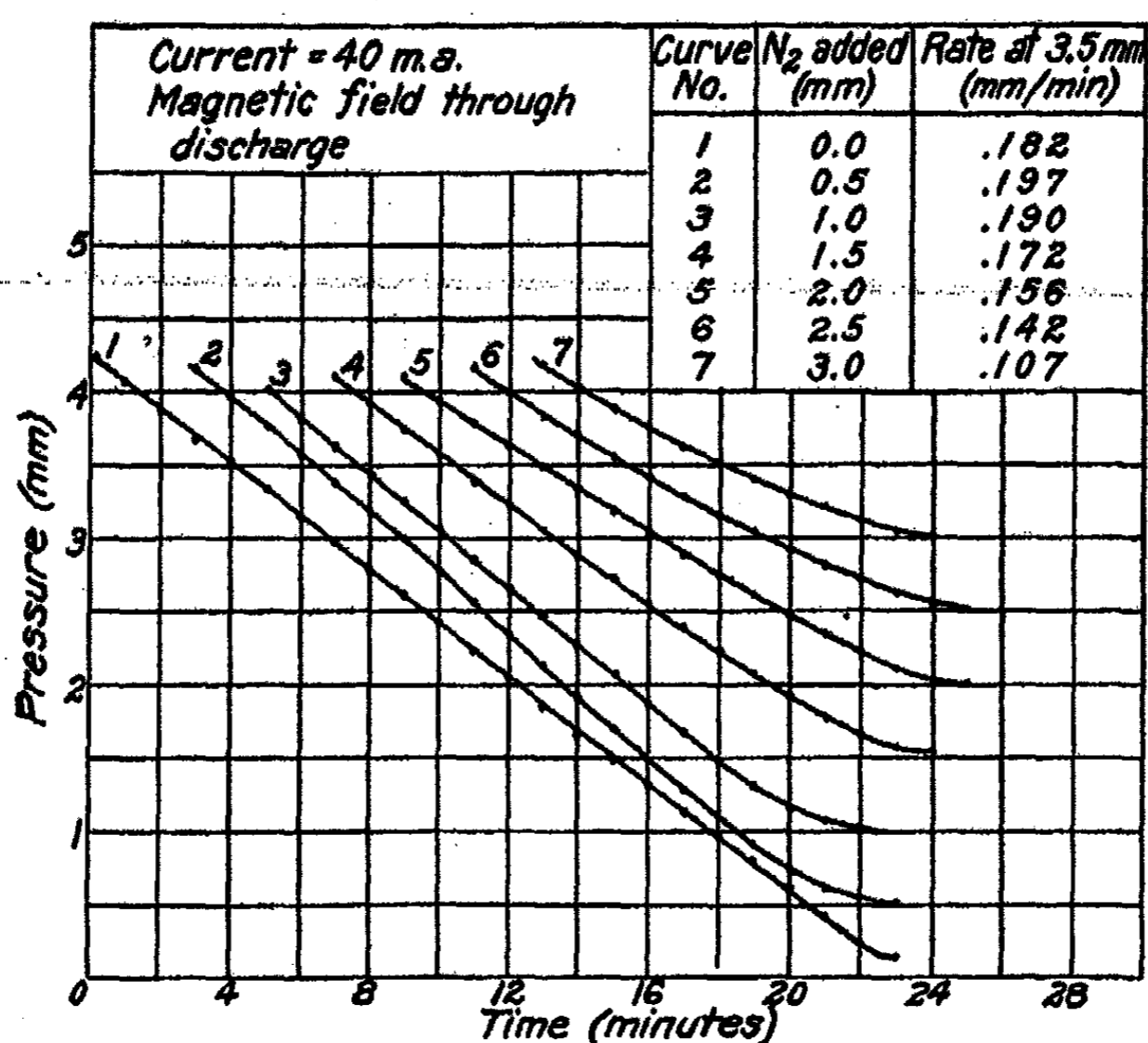

FIG. 3  
Time-Pressure Curves for Excess Nitrogen

The maximum rate of synthesis for the hydrogen-nitrogen combinations was obtained at approximately a  $2\text{H}_2\text{-N}_2$  mixture rather than at  $3\text{H}_2\text{-N}_2$  as would be expected from the combining ratio. Thus, in Fig. 5 it will be seen that the addition of nitrogen to the  $3\text{H}_2\text{-N}_2$  mixture increases the rate of synthesis until a  $2\text{H}_2\text{-N}_2$  ratio is reached. The addition of hydrogen to the  $3\text{H}_2\text{-N}_2$  mixture always slows down the reaction.

Since the rate as given by the slopes of the lines in Fig. 3 is independent of the absolute pressure of the gas, depending only on the ratio of nitrogen to hydrogen, values similar to those obtained from the slopes of all the lines at 3.5 mm. could be obtained from the tangents to line 2 alone, taken at points representing the corresponding gas ratios. The use of a complete set of curves

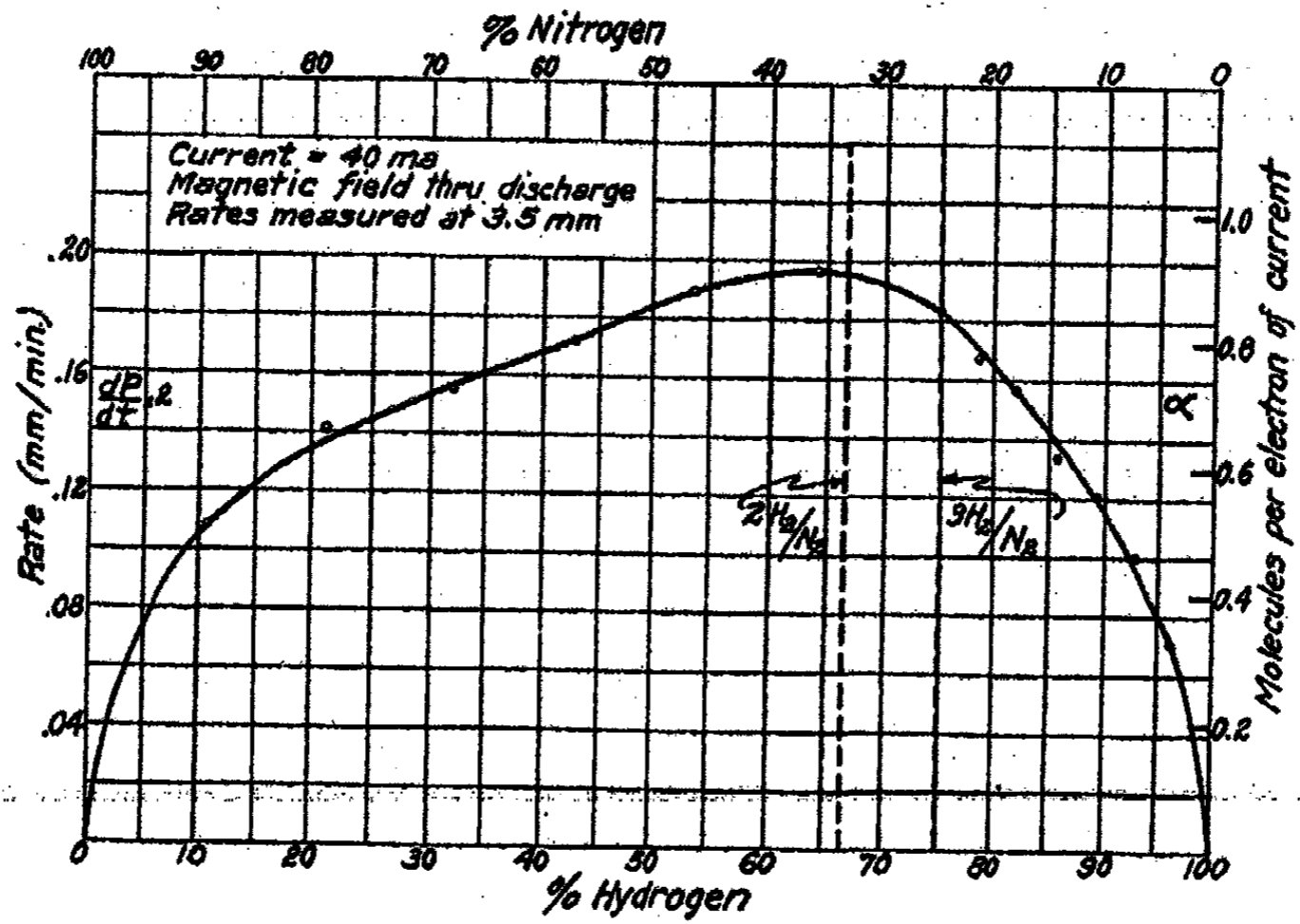

FIG. 4  
Rate Curve for Various Nitrogen-Hydrogen Mixtures

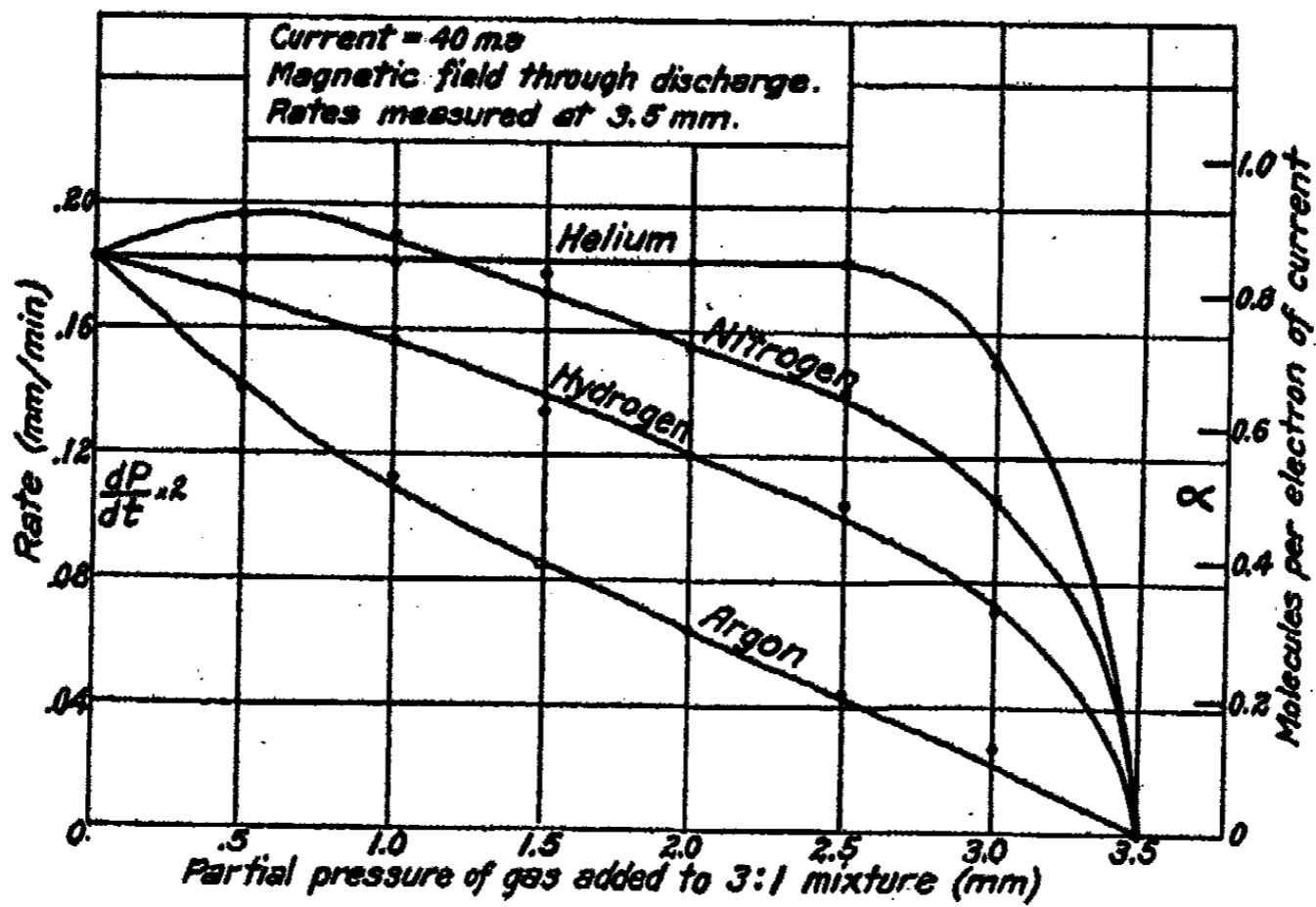

FIG. 5  
Effect of Added Gases on the Rate of Synthesis

rather than a single curve enabled a more reliable determination of the reaction rates and corresponding gas ratios.

In Fig. 4 the points on either side of the maximum fall fairly well on straight lines. It is interesting to note that the slopes of these lines have a numerical ratio to one another of 1 to 3. This indicates that, over the range of compositions to the right, the addition of nitrogen to the hydrogen-nitrogen mixture has three times the effect in speeding up the rate as a corresponding addition of hydrogen has when added to a nitrogen-hydrogen mixture in the range of compositions to the left.

The effect of argon and helium on the rates of synthesis is plotted in Fig. 5. Helium when added in any quantity up to 70% of the total quantity of gas present had no effect whatsoever on the rate of synthesis. Argon, however, when added even in small amounts slowed down the rate in a very pronounced manner. Since the argon contained traces of nitrogen, the actual effect is doubtless more pronounced than that indicated by the curve.

An attempt was made to find the effect of mercury vapor on the rate by using a U tube in which the usual aluminum electrodes were replaced by mercury. The results obtained, however, were the same in both cases because the mercury vapor pressure in the cooled portion of the tube was too low to give an observable effect.

#### Discussion of Results

In the previous paper it was shown that the synthesis of ammonia was initiated by the positive ions formed in the discharge, the reaction going to completion in the gas phase. This conclusion resulted from the facts that the rate of synthesis for a given set of operative conditions is proportional to the current and is independent of the pressure, the spectrum, or the intensity of the glow emitted. The spectrum changed completely throughout the course of a single run; a pure band spectrum was obtained at the high pressures, while the emission at low pressures was almost entirely lines. Not only did the intensity of the emitted light vary greatly from pressure to pressure, but the total glow in the tube could be considerably reduced in intensity and completely confined to a thin sheet between the electrodes by a magnetic field parallel to the electric field without producing any effect whatsoever on the rate of synthesis.

Crew and Hulburt<sup>1</sup> have shown that the concentration of nitrogen atoms is very low in a discharge of this type, also that the concentration of hydrogen atoms varies markedly with the pressure, rising sharply from a very low concentration at pressures above 2 mm. to a high maximum in the neighborhood of 0.4 mm. Their results show further that the concentration of atoms in the discharge varies but slightly with the power input and is, therefore, nearly independent of the current.

The rate of production of excited molecules is also a complex function of the pressure and temperature, the maximum concentration being reached at

<sup>1</sup> Crew and Hulburt: *Phys. Rev.*, (2) 29, 843 (1927); 30, 124 (1927).

pressures of several millimeters, depending on the gases and the character of the discharge.

The proportionality between current and rate, and the independence of pressure, therefore, not only eliminate atoms and excited molecules as initiators of chemical action, but also eliminate a mechanism involving an interaction between either of them and positive ions.

In the present paper the results obtained by the addition of various gases to the  $3\text{H}_2\text{-N}_2$  mixture enable a comparison to be made of the relative abilities of the  $\text{H}_2^+$  and  $\text{N}_2^+$  ions to initiate the reaction.

The rate of production of  $\text{N}_2^+$  and  $\text{H}_2^+$  ions in the discharge is given directly from the mixing ratios and the stopping powers,<sup>1</sup> i.e., the relative number of ions formed per electron per cm. of path, taking helium as 1.0. The stopping powers of nitrogen and hydrogen are 8.72 and 2.84, respectively. The ratio of  $\text{N}_2^+$  to  $\text{H}_2^+$  is, therefore,  $8.72/3 : 2.84$ , or  $1.02 : 1.0$ , in a  $3\text{H}_2\text{-N}_2$  mixture.

Since the total positive ion production does not change materially with a change in the nitrogen-hydrogen ratio, the effect of changing the ratio of  $\text{N}_2^+$  to  $\text{H}_2^+$  is illustrated by Fig. 4. It will be seen that the rate of synthesis increases with increasing  $\text{N}_2^+$  production, reaching a maximum at an approximate  $2\text{H}_2\text{-N}_2$  ratio, where the ratio of  $\text{N}_2^+$  to  $\text{H}_2^+$  is about  $1.5 : 1.0$ . Thus, while nitrogen and hydrogen combine in a 3-1 ratio and should be expected to give a maximum yield when mixed in these proportions, the fact that the maximum occurs near a  $2\text{H}_2\text{-N}_2$  mixture indicates that  $\text{N}_2^+$  ions are relatively much more efficient in initiating chemical action than are  $\text{H}_2^+$  ions.

The relative efficiencies of the  $\text{N}_2^+$  and  $\text{H}_2^+$  ions are brought out in a much more emphatic manner when the rates of synthesis in the presence of helium and argon are considered in connection with the relative ionization potentials of these gases. The values are as follows:

	$\text{N}_2$	$\text{H}_2$	A	He
Ionization potential	16.8 v	15.3 v	15.7 v	24.5 v
Stopping power	8.72	2.84	8.87	1

The effect of adding argon to the  $3\text{H}_2\text{-N}_2$  mixture is to materially change the ratio of  $\text{N}_2^+$  to  $\text{H}_2^+$  ions in the discharge. This results directly from its high stopping power and from the fact that its ionization potential falls between that of nitrogen and hydrogen.

Argon, due to its high stopping power, will markedly decrease the rate at which  $\text{N}_2^+$  and  $\text{H}_2^+$  ions are initially formed in the discharge. The ionization potential of argon is, however, 0.4 v higher than that for hydrogen, so the chance of the  $\text{A}^+$  ion transferring its charge to hydrogen forming an  $\text{H}_2^+$  ion becomes very appreciable, especially since an  $\text{A}^+$  ion will make on the average about  $10^3$  collisions with hydrogen molecules before reaching the walls or becoming neutralized. The net result of additions of argon is, therefore, to cut down the production of  $\text{N}_2^+$  and to increase that of  $\text{H}_2^+$ . The decrease in

<sup>1</sup> Compton and Van Voorhis: Phys. Rev., (2) 27, 724 (1926).

(Note:—We have chosen the values of Hughes and Klein, corrected by Compton and Van Voorhis, as representing the most accurate values for the stopping power).

the rate of synthesis upon addition of argon can be entirely accounted for by the decrease in  $N_2^+$  ion production.

The zero effect of helium on the rate of synthesis may be accounted for also on the basis of the same general considerations as those used in the case of argon. The low stopping power of helium, as compared to nitrogen, prevents the accumulation of large quantities of  $He^+$  ions in the discharge, except at very large helium concentrations. Then, since the ionization potential of helium is some 8.0 v higher than that of either nitrogen or hydrogen, it is possible for the  $He^+$  ion to transfer its charge upon collision with nitrogen and hydrogen molecules to form  $N_2^+$  and  $H_2^+$  ions. The net result, therefore, is no appreciable change in the number of  $N_2^+$  or  $H_2^+$  ions formed in the discharge, and hence no change in the rate of synthesis.

From the above considerations it must be concluded that no marked synthesis can be attributed to  $H_2^+$  ions;  $N_2^+$  ions alone of all the products formed in the discharge, seem capable of initiating the synthesis of ammonia.

#### A Probable Mechanism

The most logical interpretation of the data presented in this paper is that the synthesis of ammonia takes place around  $N_2^+$  ions formed in the discharge. The reaction process, therefore, may be divided into two distinct sections: part 1, the formation of the  $N_2^+$  ion, and part 2, the combining of this ion with hydrogen to form ammonia.

A consideration of the energies involved leads to the conclusion that the entire expenditure of energy in bringing about the reaction occurs in part 1. The loss of energy is necessarily appreciable, since the excited molecules, atoms, and  $H_2^+$  ions formed in the discharge apparently play no part in the reaction mechanism. The positive ion current, which may be appreciable, also represents an energy loss.

While the data throw no direct light on the nature of the second part of the reaction mechanism, it is nevertheless possible to draw certain conclusions concerning the interaction between  $N_2^+$  ions and hydrogen molecules. As has been pointed out, the average ion in these experiments will make many collisions with neutral molecules before reaching the walls. Sir J. J. Thomson<sup>1</sup> has given the attraction between a positive ion and a neutral molecule as  $e^2b^3/2r^4$ , where  $b$  is the molecular radius and  $r$  is the distance separating the two. He assumes attachment will occur when  $e^2b^3/2r^4 > 3/2 kT$ , i.e., the force of attraction is greater than the kinetic agitation of the gas. These expressions were derived on the assumption that only ordinary electrostatic forces are in evidence and that the ions and molecules behave as charged and uncharged metallic spheres. This assumption, however, does not apply in the cases where chemical action can take place between the ions and the attached molecules, for under these conditions it is probable that an electronic rearrangement will take place in which the forces of attraction are much greater than those calculated by the Thomson equation. Thus large clusters

<sup>1</sup> Phil. Mag., (6) 47, 337 (1924).

may be built up by the addition of neutral molecules before a point is reached where the force of attraction is balanced by the kinetic agitation of the gas. Since an  $N_2^+$  ion will make in the neighborhood of  $10^8$  collisions with hydrogen molecules before reaching the walls, the possibility for the formation of relatively large clusters exists.

While it is possible to set up many types of equations which might represent the mechanism of interaction between  $N_2^+$  and  $H_2$ , only three will be considered here, which seem the most probable. The first two mechanisms will be based on the cluster ideas just presented, while the third will be based on considerations of the energy of combination as put forward by Franck.

**Mechanism 1.** This mechanism involves the idea of intermediate compound formation, and represents an attempt to correlate the hypothesis<sup>1</sup> already put forward by chemists with the results obtained in this work. The reaction process may be represented by the following equations:

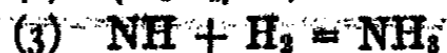
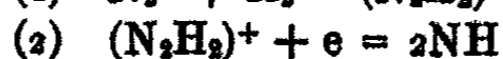
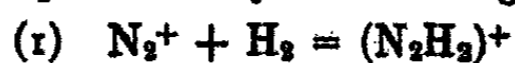

In postulating a mechanism of this type, it is necessary to assume that the probability of the NH complex combining with hydrogen to form ammonia is 1.0, otherwise the rate would not be independent of the pressure. This endows the intermediate NH with such stable properties that its loss to the system, by processes other than combination with hydrogen, is negligible.

**Mechanism 2.** This mechanism is based on the large cluster theory in which the  $N_2^+$  ion, because of its charge and its ability to enter into chemical combination with hydrogen, is capable of associating itself with several hydrogen molecules forming an aggregate which upon neutralization yields two molecules of ammonia. This may be expressed by the following equations.

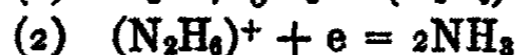

Fortunately, these two mechanisms are sufficiently different so that the more probable one can be picked with reasonable certainty. According to the first mechanism the rate is determined by the formation of a complex NH in which the nitrogen and hydrogen combine in the ratio 1:1. According to the second mechanism, the rate is determined by the formation of the cluster  $(N_2H_6)^+$ , in which the combining ratio is 1:3. By reference to Fig. 4 it will be seen that nitrogen is three times as effective as hydrogen in increasing the rate. It appears, therefore, that the second mechanism is in better agreement with the facts than is the first.

**Mechanism 3.** A third type of mechanism is possible which involves neither gas phase neutralization of a positive ion by an electron or negative ion, nor the formation of large clusters. This is illustrated by the following equations:

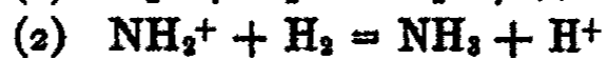
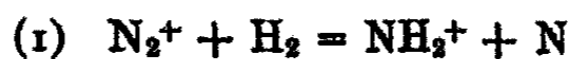

<sup>1</sup> Bernard Lewis: J. Am. Chem. Soc., 50, 27 (1928).

This type of mechanism is as satisfactory as Mechanism 2 in providing a means for the removal of the energy liberated in the reaction process, accomplished in this case by the splitting off of nitrogen atoms and  $H^+$  ions.

While Mechanisms 2 and 3 may be equally probable as far as the general character of the data and energy considerations are concerned, they differ markedly in that Mechanism 2 yields two molecules of ammonia per  $N_2^+$  ion, while Mechanism 3 yields but one. A determination of the ratio of ammonia molecules to  $N_2^+$  formed in the discharge would, therefore, serve to distinguish between these two reaction processes.

Unfortunately the number of positive ions formed in the negative glow cannot be determined closer than a factor of two, because of the uncertainties involved in an understanding of discharge tube phenomena.

In the first place, the amount of current carried by the electrons and the positive ions is not known with certainty. While it has been conceded generally that the current is divided between the electrons and positive ions according to their respective mobilities, Aston<sup>1</sup> has shown in a series of experiments, wherein the conditions were quite similar to those in the present work, that the current is divided equally between the two types of carriers, half being carried by electrons and half by positive ions. In case only half the current in the discharge is carried by electrons, the total number of positive ions capable of initiating the reaction is but one-fourth what it would be were the positive ion current negligible. This uncertainty, therefore, introduces a maximum possible factor of four in an evaluation of the total number of positive ions reacting.

Another uncertainty arises in determining what fraction of the positive ion current is carried by the  $H_2^+$  ions and by the  $N_2^+$  ions. The greater mobility of the  $H_2^+$  ions will doubtless result in the ratio of  $H_2^+$  to  $N_2^+$  ion currents being greater than that of their rates of formation. This would tend to increase the concentrations of  $N_2^+$  ions in gas mixtures of high hydrogen concentration.

An exact evaluation of the effective voltage of the electrons entering the negative glow presents further uncertainties. This voltage, however, cannot be far from the optimum ionizing potential of the gases,<sup>2</sup> which in the present case is in the neighborhood of 100 volts. The best that can be said, therefore, is that the number of positive ions formed per electron entering the negative glow is in the neighborhood of two, perhaps slightly less.<sup>3</sup>

In making the computations for Figs. 4 and 5, it was assumed that the entire current is carried by electrons. If this assumption is correct, then a maximum yield of very nearly one molecule of ammonia per  $N_2^+$  ion is obtained. This yield is in fair agreement with the values of Lind and Bardwell<sup>4</sup> who found an  $MNH_3/NN_2^+$  ratio of about 0.5, which is doubtless slightly

<sup>1</sup> F. W. Aston: Proc. Roy. Soc., 96, 200 (1919).

<sup>2</sup> Hughes and Klein: Phys. Rev., (2) 23, 450 (1924); Compton and Van Voorhis: 27, 724 (1926).

<sup>3</sup> Langmuir and Jones: Phys. Rev., (2) 31, 403 (1928).

<sup>4</sup> Lind and Bardwell: J. Am. Chem. Soc., 50, 745 (1928).

low due to the experimental difficulties involved. Such a yield is in complete agreement with the demands of Mechanism 3. On the other hand, if Aston's results are correct, approximately four molecules of ammonia are obtained per  $N_2^+$  ion, which is more in accord with Mechanism 2.

Possibly the most accurate ratio of molecules to ions (M/N) can be had by computing the number of  $N^+$  ions on the basis that the positive ion current is negligible. If this assumption is correct, the yields given in Fig. 4 are very close to two molecules of ammonia for each  $N_2^+$  ion in gas mixtures containing less than 5% nitrogen. For higher nitrogen concentrations the yield per  $N_2^+$  ion falls off almost linearly with the partial pressure of nitrogen, over a wide composition range, due probably to the loss of  $N_2^+$  ions to the walls and electrodes.

In conclusion it may be said that, while the yields at low nitrogen concentrations appear to favor a mechanism giving  $M_{NH_3}/N_{N_2^+} = 2$ , the uncertainties are so great that a choice cannot be made between Mechanisms 2 and 3 for the second part of the reaction process.

The writers wish to express their appreciation to Mr. J. Reuter, instrument maker, for the construction of the electrostatic voltmeter used in these experiments.

#### Summary

The various factors contributing to the rate constant  $\alpha$  for the synthesis of ammonia in the glow discharge have been considered separately. Especial attention has been given to the portion of the discharge wherein the synthesis takes place, and to the effects of various added gases on the rate.

The data when interpreted from the standpoint of the ionization potential and stopping power of the different gases, indicate that the synthesis is initiated, principally if not entirely, by  $N_2^+$  ions; the production of atoms, excited molecules and  $H_2^+$  ions represents energy lost to the system.

The reaction mechanism is divided into two steps: first, the production of  $N_2^+$  ions, and second, the union of the  $N_2^+$  ion with hydrogen to form ammonia.

Three mechanisms for the second step are considered. The first two involve the clustering of hydrogen around the  $N_2^+$  ion yielding on neutralization two molecules of  $NH_3$  for each available  $N_2^+$  ion. The third mechanism allows for the dissipation of energy and does not involve an electron neutralization; the yield is one molecule of  $NH_3$  for each available  $N_2^+$  ion.

A quantitative analysis of the data shows that a distinction between these mechanisms cannot be made on the basis of the observed yield because of lack of knowledge concerning discharge tube phenomena.



## DOUBLE REFRACTION IN CELLULOSE ACETATE AND NITRATE FILMS\*

BY JAMES G. McNALLY AND S. E. SHEPPARD

82-50  
34-22

Although the double refraction of stretched cellulose nitrate films was discovered by Ambronn<sup>1</sup> in 1898 and has been extensively investigated since,<sup>2</sup> the optical properties of non-deformed cellulosic films have received but scant attention and the available data appear to be of conflicting nature. Ambronn<sup>3</sup> states that unstrained nitrocellulose films are isotropic; while

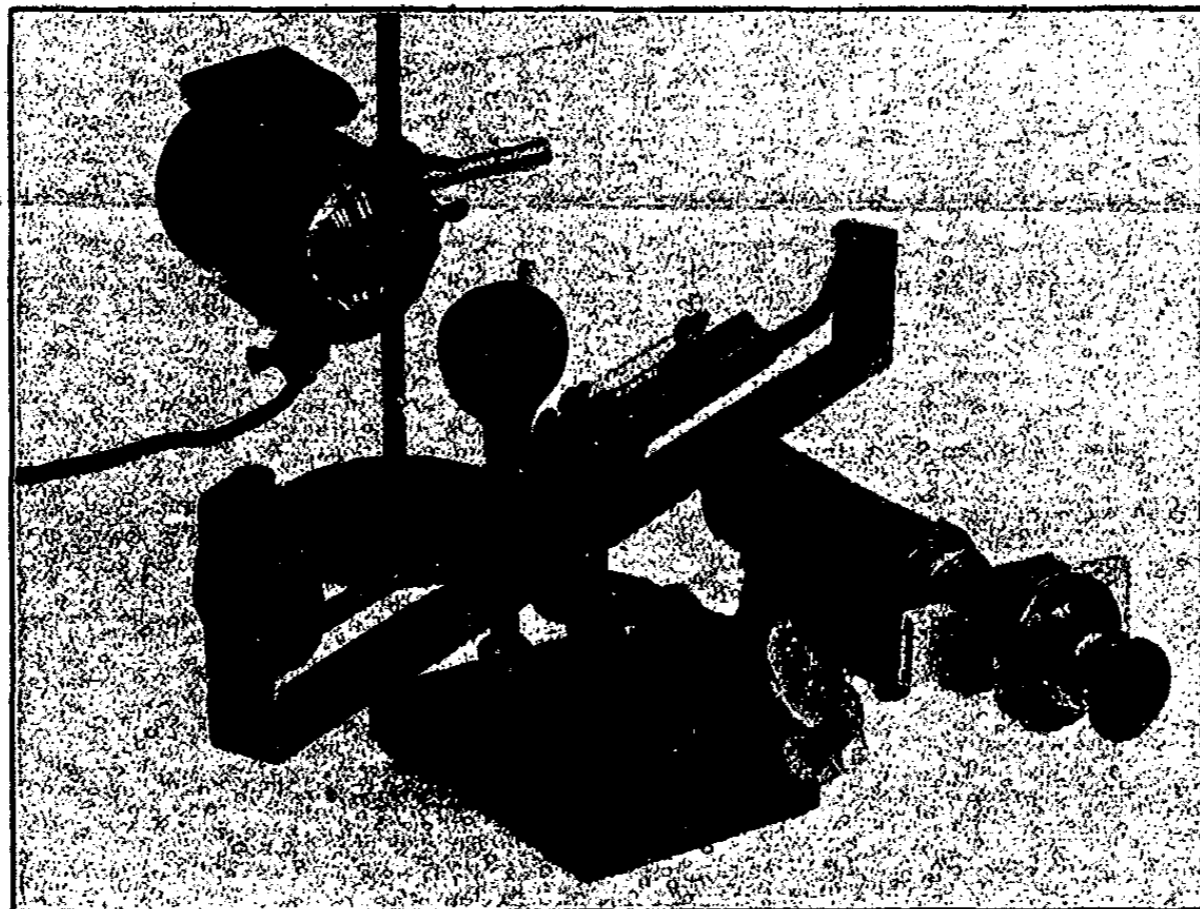

FIG. 1

Polariscope used for studying the Double Refraction of Cellulosic Films

Duclaux<sup>4</sup> found that they resemble sections of uniaxial crystals cut with the optic axis perpendicular to the surface. Mauguin,<sup>5</sup> however, has examined regenerated cellulose films which were biaxial, although the uniaxial cellulose nitrate films of Duclaux gave uniaxial films of regenerated cellulose on denitration. The present work was undertaken to find the cause of the variable optical characteristics of cellulosic films.

\* Communication No. 365 from the Kodak Research Laboratories. Presented at the Swampscott meeting of the American Chemical Society, September 17, 1928.

<sup>1</sup> Ber. sächs. Akad. Wiss. math. physik. Klasse, 1898, 1-31.

<sup>2</sup> A summary of this work is given by Wächtler: Fortschr. Min. Kryst. Petr., 12, 119-189 (1927).

<sup>3</sup> Ber. sächs. Ges. math. physik. Klasse, 63, 249 (1911).

<sup>4</sup> Solvay Reports, 1926, 104.

<sup>5</sup> Quoted from C. Fabry: J. physique et radium, 5, 60 S (1924).

### Apparatus

The usual polarizing microscope using convergent polarized light was found to be unsuitable for the examination of films of cellulose acetate or nitrate as the interference figures were indistinct or absent in films showing weak double refraction. Moreover, this method has the distinct disadvantage that the sample of film can be rotated with respect to the plane of vibration of the light in only one of three perpendicular planes and it will be shown later

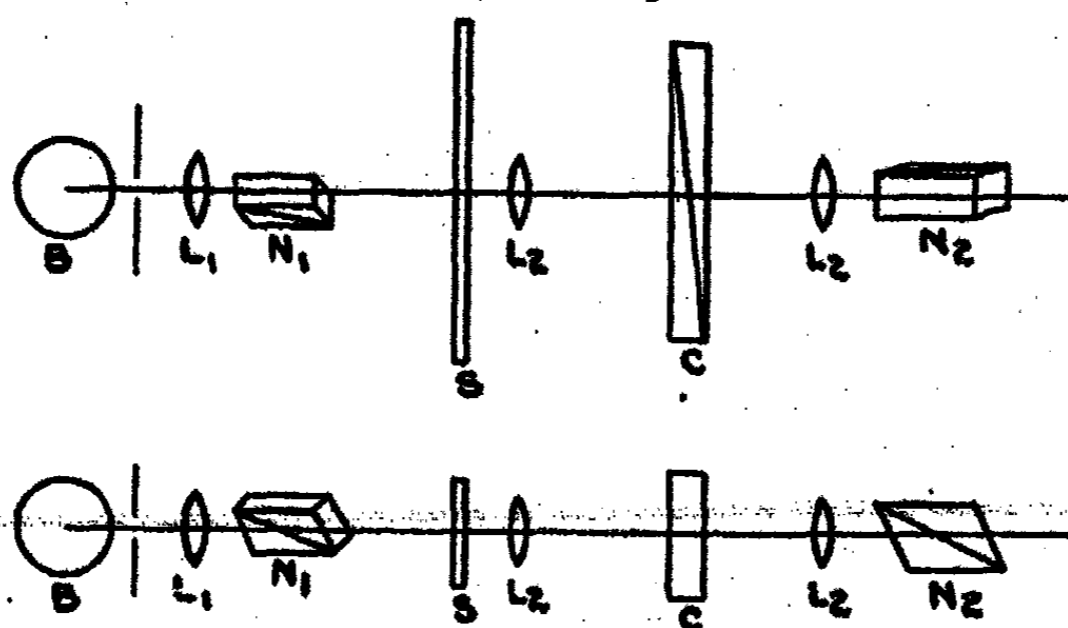

FIG. 2

Plan and Elevation of the Optical System of the Polariscope

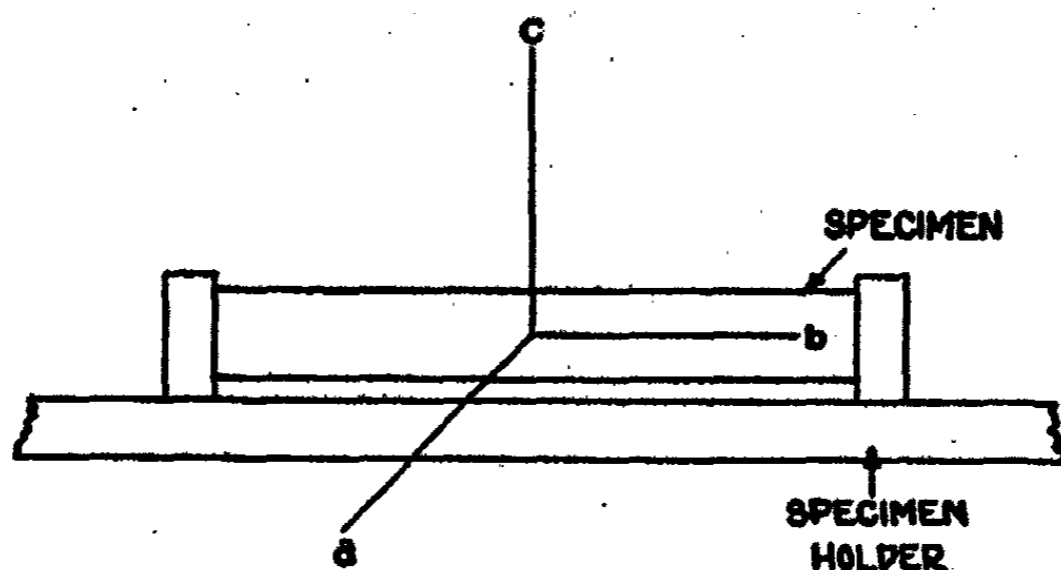

FIG. 3

Reference Axes for Birefringence Measurements

that much useful information may be obtained by rotating the specimen in all three planes. A photograph of the instrument built for this purpose is shown in Fig. 1 and the optical system is indicated by Fig. 2. Light from the source B is collimated by the lens,  $L_1$ . The specimen to be examined, S, is placed between the polarizing and analyzing nicols,  $N_1$  and  $N_2$ , and viewed through the objective lens,  $L_2$ , and the eyepiece,  $L_3$ . The phase shift in the polarized light caused by passing through the specimen is compensated by the Babinet compensator, C; and the cross-hair, X, is used as a reference mark for the zero reading of the Babinet. The double refraction of the film is proportional to the distance necessary to shift the Babinet from its zero

position to make the black interference line coincide with the cross-hair. This is measured by a scale cut into the compensator. The scale was calibrated with sodium light and a scale reading of 589 divisions corresponds to a retardation of one wave-length for light of  $\lambda = 589 \text{ m}\mu$ . By rotating either the specimen holder or the nicols and compensator, the double refraction of the specimen may be measured at any angle to the plane of vibration of the incident light. The position of the specimen may be determined with relation to reference axes by the three circular scales shown in the photograph. The reference axes will be denoted, A, B, and C, and their location is shown in Fig. 3. Whenever a stretched film was examined, it was so placed in the holder that the direction of stretch coincided with the B-axis.

### Experimental Results

The optical properties of a transparent colloidal film may be determined by placing the film in the instrument just described and reading the Babinet while the film is rotated successively about the A, B, and C axes. The double refraction was plotted against the angle at which the measurement was made and the curve thus obtained compared with the results of similar measurements on crystal sections of known symmetry. In the following discussion, the quantity

$$\frac{\delta \cos \theta}{d}$$

is used as a measure of the double refraction of the film. Delta is the Babinet reading when the film has been rotated  $\theta$  degrees from its zero position and  $d$  is the thickness of the film in millimeters. The quantity

$$\frac{\delta \cos \theta}{d}$$

represents, then, the difference in path of the ordinary and extraordinary ray in  $\text{m}\mu$  per unit thickness of the film.

#### I. Examination of Crystal Sections

##### A. A Negative Uniaxial Quartz Plate

A section of a negative uniaxial quartz crystal 0.51 mm. thick was so cut that its optic axis was perpendicular to the plane of the large surface. The results obtained on rotating this section are shown in Fig. 4.

##### B. A Positive Biaxial Mica Plate

In Fig. 5 the values of  $\frac{\delta \cos \theta}{d}$  obtained with a mica plate 0.035 mm. thick are plotted against  $\theta$ . The difference between the two types of lattice arrangement is clearly brought out by these curves. An isotropic film would, of course, give a value of  $\delta = 0$  for any value of  $\theta$ .

#### II. Examination of Cellulosic Films

A large number of commercial film bases were selected at random and examined in the same manner as the crystal sections.

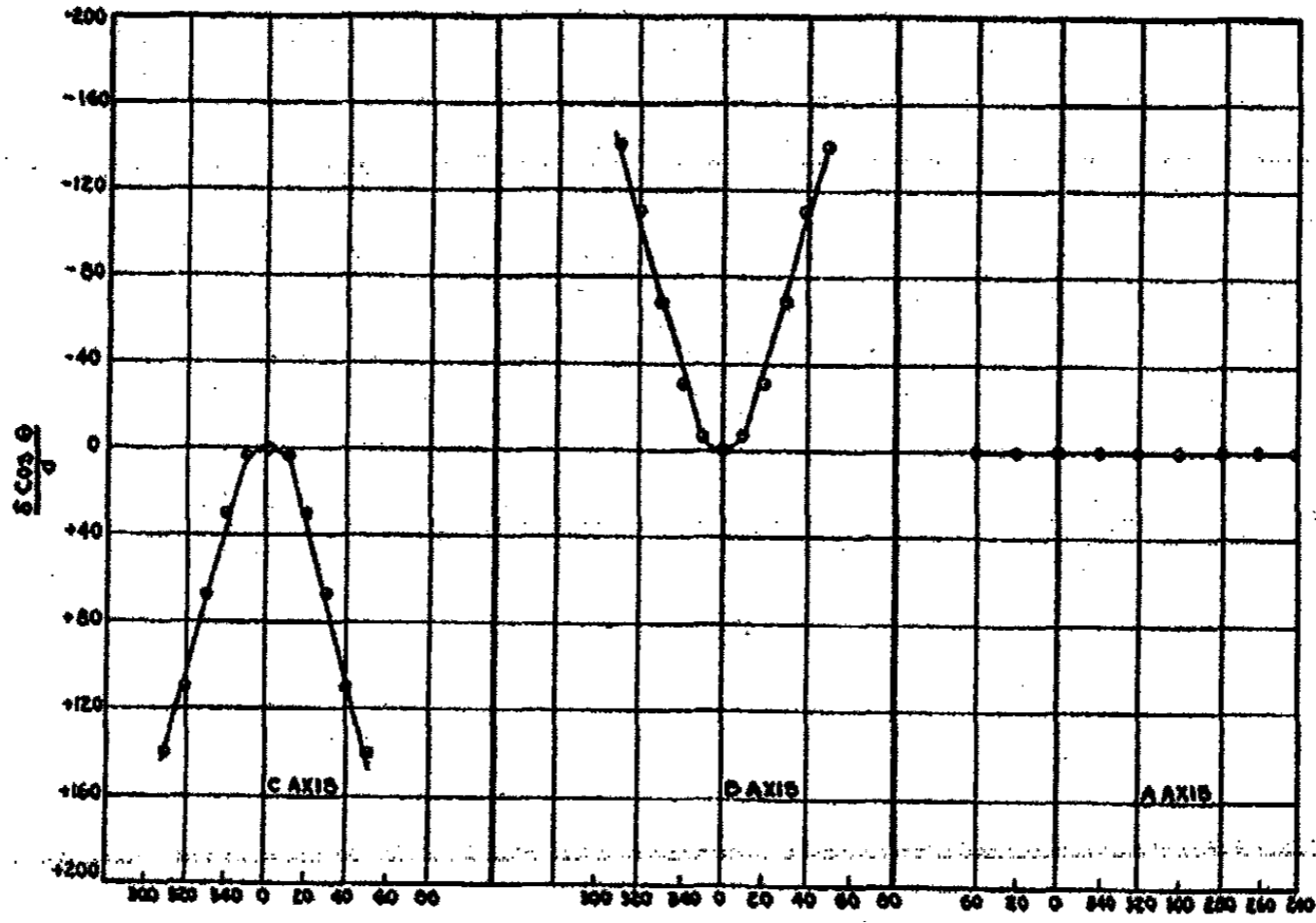

FIG. 4  
The Double Refraction of a Negative Quartz Plate

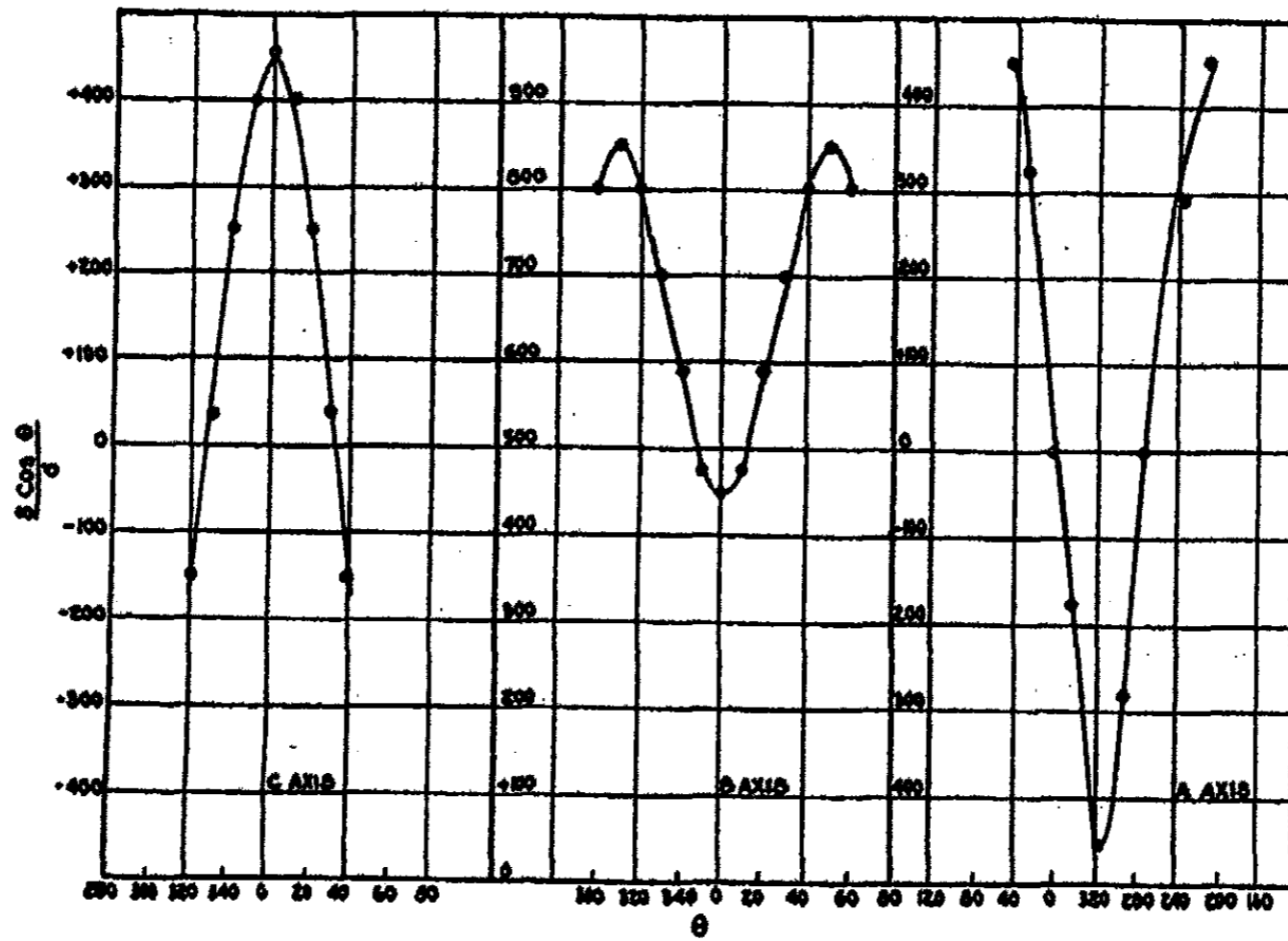

FIG. 5  
The Double Refraction of a Positive Mica Plate

Cellulose acetate films were found that were isotropic, uniaxial and biaxial, and the same was true of cellulose nitrate films. All the regenerated films examined were found to be either uniaxial or biaxial. As some of the films that differed in optical properties had been prepared from substantially the same original material, it seemed most likely that some preparative condition was responsible for the optical property of the film. It was found that biaxial, uniaxial, or isotropic films could be prepared from a given cellulose acetate or nitrate according to the *tensions on the film during the drying process*.

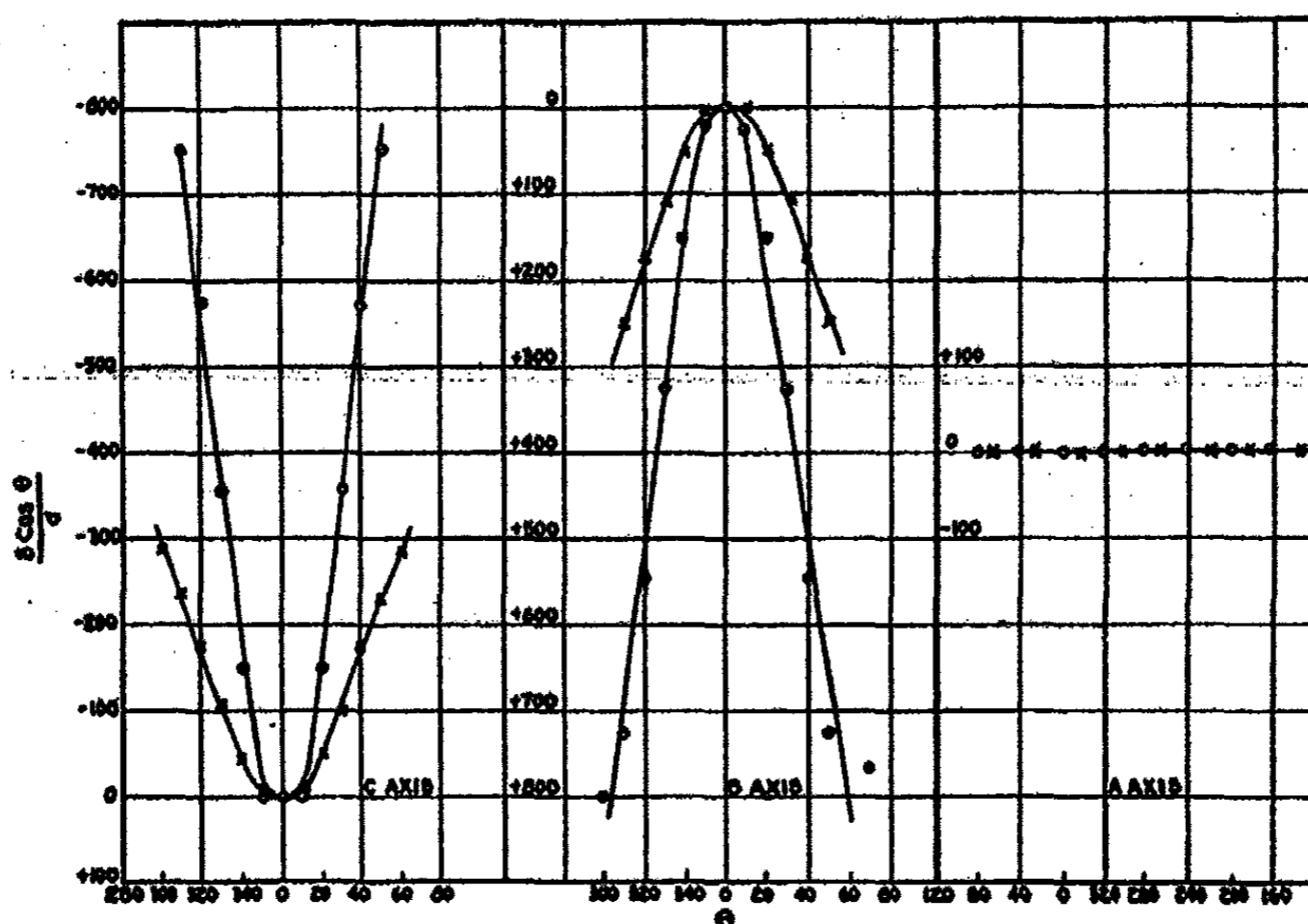

FIG. 6

The Double Refraction of Uniaxial Cellulosic Films

o = cellulose acetate  
x = cellulose nitrate

#### Uniaxial Films

In general, any cellulosic film which has been dried under equal tension from all edges will form a uniaxial film if the micelles constituting the film are anisotropic. Fig. 6 shows typical curves obtained from a cellulose diacetate and a cellulose nitrate (11.2% N). The films were prepared by coating a fifteen per cent solution on a glass plate and allowing it to dry thoroughly before stripping the film from the support.

Similar results are obtained if the film is stripped while it still contains about fifteen per cent of solvent, and then dried in any clamping arrangement that will maintain an equal tension in all directions in the plane of the large surface of the film. The curves are the same as those obtained with the negative uniaxial quartz section except that the sign is reversed for each measurement. The film, then, presents a positive uniaxial crystal section with optic axis perpendicular to the plane of the large surface of the film.

### Biaxial Films

If the film is subjected to a greater strain during drying in one direction than in any other the resulting film shows a biaxial arrangement where the second axis lies in the direction of stretch. Fig. 7 shows the results obtained from "cellulose diacetate" and nitrate films that were coated as described above and stripped while still containing considerable solvent. The films were then subjected to a differential stress and thoroughly dried in this state.

Further, uniaxial films were found to become biaxial if they were subjected to a strain beyond their elastic limits even after all solvent had been carefully

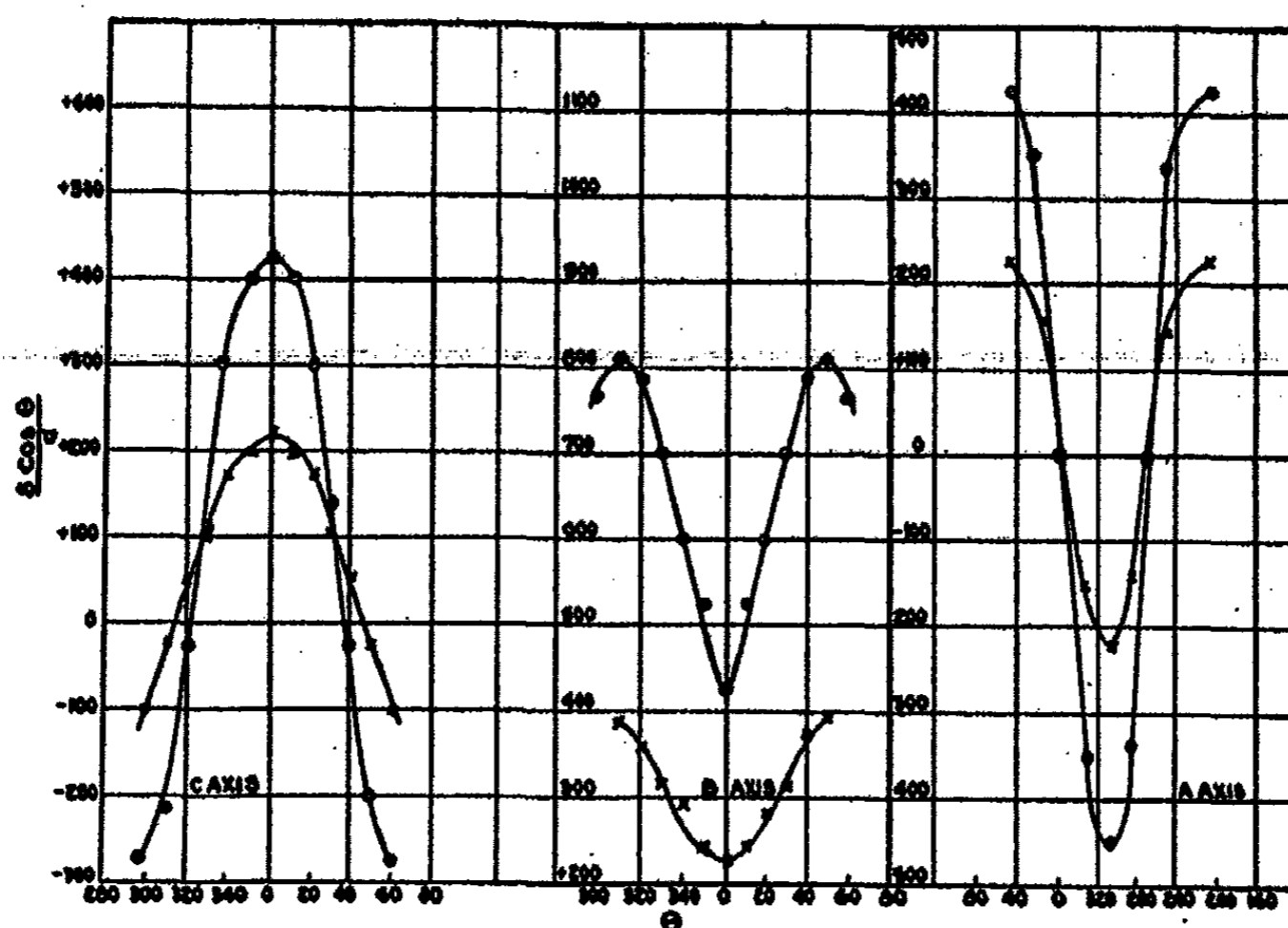

FIG. 7

The Double Refraction of Biaxial Cellulosic Films

o = cellulose acetate  
x = cellulose nitrate

removed. If strained within their elastic limit, the uniaxial films became biaxial with the second axis in the direction of stretch but they returned to the uniaxial arrangement when the stress was removed.

### Isotropic Films

The conclusion seemed inevitable that the double refraction in cellulose acetate and nitrate films is caused by the orientation of anisotropic particles of the colloid under the influence of mechanical forces present during drying. If this is true, a film dried under no differential tension and free to contract in all directions should be isotropic. This condition was approximated by pouring a two per cent solution of either cellulose acetate or nitrate on a clean mercury surface and allowing it to dry so slowly that the concentration of solvent in the film remained uniform over its whole area. All films made in this manner were completely isotropic.

The films just described were isotropic because of a random arrangement of anisotropic particles. Films may appear optically anisotropic, however, for other reasons. Ambronn<sup>1</sup> has shown that the addition of negatively doubly refracting camphor to a positively birefringent cellulose nitrate results in an isotropic film. We have prepared isotropic nitrate and acetate films by incorporating ten per cent of camphor in the solution and drying the film on a glass plate in the manner described for uniaxial films. When the camphor is removed by extracting the film with alcohol, the positive uniaxial arrangement of the cellulose micelle is revealed, a procedure that may be used to distinguish the two kinds of isotropic films.

A third variety of isotropic cellulose acetate film was made by coating and drying a chloroform solution of a cellulose acetate of the composition of

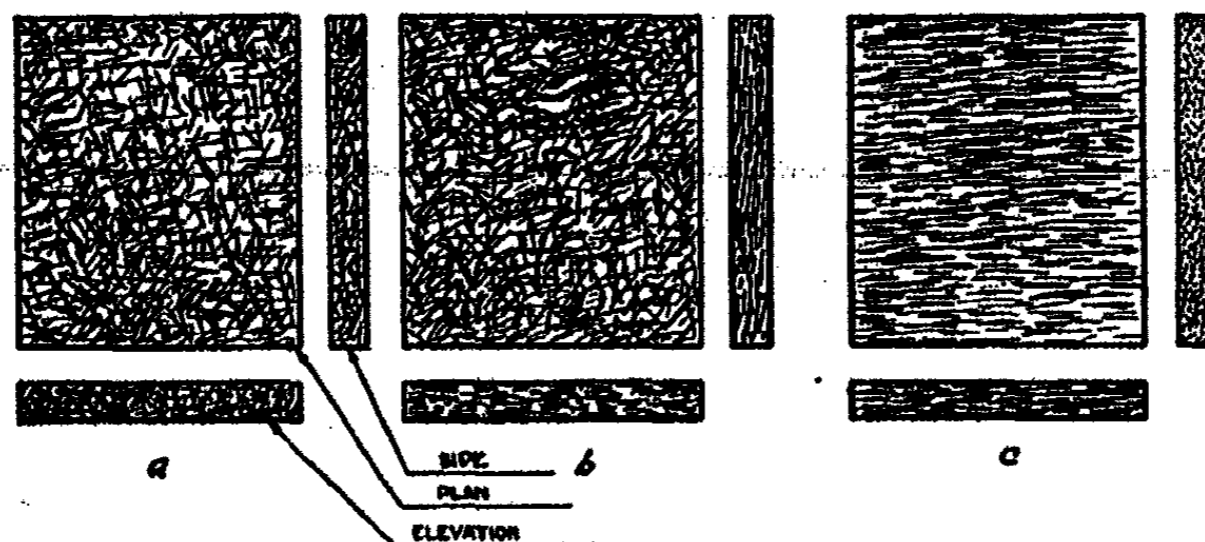

FIG. 8

The Arrangement of Micelles in Cellulosic Films of Different Optical Character.

- a = isotropic film
- b = uniaxial film
- c = biaxial film

triacetate.<sup>2</sup> The secondary acetate prepared by hydrolizing this "triacetate" gave a uniaxial film under the same conditions. Whether or not an isotropic cellulose nitrate film can be obtained by varying the nitrogen content has not yet been determined.

The arrangement of the cellulose acetate or nitrate micelles in the various films is pictured in Fig. 8 in which (a) represents plan, side and elevation sections of an isotropic film, (b) a uniaxial film, and (c) a biaxial film.

The investigation detailed does not decide the question whether the particles whose orientation determines the optical properties of the films are multi-molecular, or whether they are identical with the long thin micelles of cellulosic bodies disclosed by the investigations on thin films, in this Laboratory.<sup>3</sup> They might, in fact, be identical with these latter or consist of bundles

<sup>1</sup> Ber. stöhs. Ges. math.-physik. Klasse, 63, 249, 402 (1911).

<sup>2</sup> This material, however, may have been a mixture of cellulose acetate lower than triacetate with products of acetolysis—e.g., cellobiose octacetate.

<sup>3</sup> Sheppard and Keenan: Nature, 121, 982 (1928); Sheppard, Keenan and Nietz: Ind. Eng. Chem., 21, 126 (1929); Keenan: J. Phys. Chem., 33, 371 (1929).

of these, either pre-existent as crystallites, or formed out of solution by parallel ordering. In any case, it appears that they must be unsymmetrical in shape, rod or lath-like, having one axis considerably longer than the others.

It was planned to examine the "fine structure" of these cellulosic films prepared under different conditions of tension by study of the X-ray diffraction patterns. An extensive investigation on these lines has now been made by Dr. J. J. Trillat, of the Kodak-Pathé Research Laboratories, Vincennes, France, the results of which are in excellent agreement with our own, but extend the conclusions as to the molecular entities affected.

#### Summary

1. An instrument, particularly well suited for determining the direction of orientation of micelles in transparent colloidal films, has been described.
2. It has been shown that the optical properties of cellulose acetate and nitrate films depend on the forces acting on the film during drying.

*Rochester, N. Y.*  
*June 14, 1929.*



## GERMANIUM XXXII. ALLOYS OF GERMANIUM

### A Preliminary Survey of the System Lead-Germanium

BY T. R. BRIGGS AND W. S. BENEDICT

In the first<sup>1</sup> of this series of papers dealing with the alloys of germanium, the system silver-germanium was shown to be a simple eutectiferous mixture, the solid phases in equilibrium with the melt being pure germanium and a saturated solid solution of germanium in silver. When compared with the systems silver-silicon and silver-tin, the system silver-germanium showed the germanium to be intermediate between silicon and tin, quite as one would expect, the resemblance to silicon being the more pronounced. Kroll<sup>2</sup> found a like similarity between germanium and silicon in his work on germanium duralumins.

In response to certain requests for information concerning mixtures of lead and germanium, it was decided to investigate in a preliminary way the system lead-germanium in accordance with the methods employed by Briggs, McDuffie, and Willisford in their work on the silver alloys. The apparatus and general procedure have been described at length by these authors and further details are therefore unnecessary.

The system lead-silicon has been studied by Tamaru,<sup>3</sup> who reported the two components to be immiscible in both the liquid and the solid state. The system lead-tin has of course been studied<sup>4</sup> extensively, with results which are somewhat conflicting, but it seems definitely established that the components, aside from being consolute in the liquid state, are also partially miscible as solids, the saturated solid solutions forming a simple eutectiferous series. At any rate, while lead and silicon exhibit extreme immiscibility, lead and tin possess complete miscibility in the liquid and partial miscibility in the solid. Since germanium would be expected to behave more or less like silicon, it was thought likely that the system lead-germanium would show partial if not complete immiscibility in the liquid. Such was not found to be the case, however, for the two components when fused appear to be consolute.

The lead which was used in this investigation was prepared by electrolysis and was found by spectrographic analysis to be extremely pure. It melted at 326°. The germanium<sup>5</sup> was submitted to repeated fusions in a current

<sup>1</sup> Briggs, McDuffie, and Willisford: *J. Phys. Chem.*, 33, 1080 (1929).

<sup>2</sup> *Metall und Erz*, 23, 684 (1926).

<sup>3</sup> *Z. anorg. Chem.*, 61, 42 (1909).

<sup>4</sup> Cf. Roberts-Austen: *Engineering*, 63, 203 (1897); Rosenhain and Tucker: *Phil. Trans.* 209A, 89 (1909); Degens: *Z. anorg. Chem.*, 63, 212 (1909); Guertler: *Z. Elektrochemie*, 15, 125 (1909); etc.

<sup>5</sup> A determination of the melting point gave 941°, which is rather low. Using the same sample of germanium, Mr. Roninger obtained 955°, as reported by Briggs, McDuffie and Willisford. Since the time available for his survey was limited, it was necessary to proceed without investigating further the germanium, apart from ascertaining that it was spectrographically very pure.

of purified hydrogen as described in the previous work on the silver alloys. The matched chromel-alumel thermocouples were re-calibrated and checked against a standard thermocouple.<sup>1</sup> The usual inverse-rate cooling curves were obtained for each alloy, and the thermal data were confirmed by means of photomicrographs. The data follow in Table I.

TABLE I  
Thermal Data

Alloy (Number)	Composition (Atomic Percent Lead)	Temperature (°C)	
		First Arrest	Second Arrest
1 (Germanium)	0	941-954	—
2	1.3	935	Not determined
3	3.2	926	Not determined
4	7.9	918	324
5	23	893	327
6	33	875	327
7	42	865	326
8	52	853	326
9	69	827	327
10	80	802	326
12	89	Uncertain	327
13	99	Uncertain	327
14 (Lead)	100	Uncertain	326

Owing to the lack of time available for this preliminary investigation and the difficulties met with in sampling the alloys for analysis the composition of each alloy was determined from the quantity of the two metals used in its preparation. This admittedly approximate method was checked in the case of Alloy 6, supposedly containing 46.4 percent lead. Two determinations of lead (as sulphate) gave 46.8 and 45.0 respectively. It is probable that the error in the compositions reported in this paper is not greater than  $\pm 3$  percent.

The equilibrium diagram which has been constructed from the thermal data appears in Fig. 1. It is apparent that although the components appear to be consolute above the melting temperature for germanium, the temperature of the second or eutectic arrest is identical (within the limits of accuracy of the temperature readings) with the melting point of pure lead. On cooling any melt containing both components, accordingly, the whole of the germanium tends to separate from the liquid before any of the lead, the solidification of the latter then following at the normal freezing temperature. Behavior of this sort, as Voss<sup>2</sup> has pointed out in his investigation of the system lead-nickel, means of course that germanium is not appreciably soluble in liquid lead at its freezing point, but does become increasingly soluble as the temperature is raised.

<sup>1</sup> Through the cooperation of Professor Murdock of the Department of Physics.  
<sup>2</sup> Z. anorg. Chem., 57, 47 (1908). Cf. however Portevin: Rev. Met., 4, 813 (1907).

The comparative flatness of the central portion of the liquidus curve suggests the possibility of incomplete miscibility in the melt and the existence of two liquid phases. However, the temperature falls through an interval of more than 100 degrees in this part of the curve, whereas it should be constant for a condensed system composed of two liquid phases in equilibrium

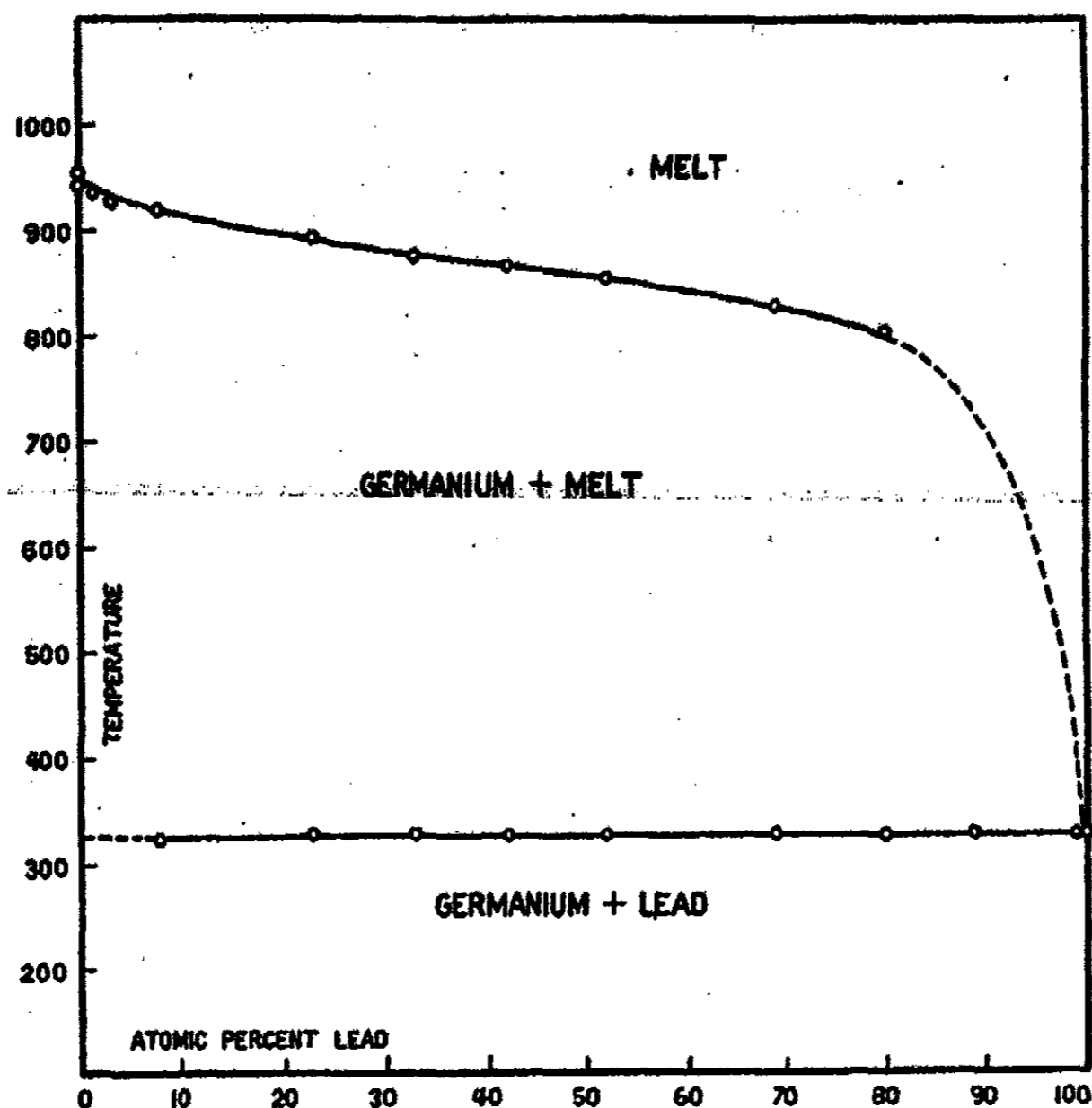

FIG. 1  
Equilibrium Diagram for Lead-Germanium

with a solid phase (germanium). Hence, since the temperature appears to change continuously along the whole curve for the first arrests, and as direct evidence of two liquid layers was not obtained, it seems best to conclude for the present that the two metals are consolute when liquid.<sup>1</sup>

<sup>1</sup> Cf. Friedrich and Leroux: *Metallurgie*, 4, 300 (1907). These investigators concluded that copper and lead form a two-liquid system, although their experimental values for the arrests along the line of invariance (two liquid phases plus solid) fell continuously from 956° to 879°. They were able, however, to obtain optical proof that two liquids were formed, since rapidly chilled alloys showed a sharp demarcation between the red copper-rich and the white tin-rich layers. We were unable with our equipment to chill-cast the alloys of lead and germanium, since it was essential to work always in an atmosphere of hydrogen, but even with the most rapid cooling possible under the circumstances, a sharp separation into lead-rich and germanium-rich layers was not obtained. There was of course much segregation of germanium at the top of each ingot, owing to the great difference in the densities of the two components, so that reliable evidence regarding the existence of liquid layers could hardly be expected.

The extreme lead end of the liquidus curve has not been determined but the fact that no first arrest was discernible beyond 80 atomic per cent of lead indicates that the curve as drawn is substantially correct. Alloy 12 (89 atomic per cent lead) was cooled from 825° but no break in the inverse-rate cooling curve greater than the ordinary chance fluctuations could be observed down to the temperature of the arrest for lead (327°). When it is considered that there is only 3.1 weight per cent of germanium in this alloy, and that this small amount must separate out over a very wide interval of temperature (owing to the steepness of the liquidus curve in this part of the diagram), the failure to observe a first arrest is not surprising.

The photomicrographs of the alloys are not particularly interesting and have not been reproduced. They all show the germanium in characteristic crystals, generally very large, imbedded in a matrix of lead. Coring was entirely absent, so that there is little likelihood of a solid solution of lead in germanium.

While the diagram for the system lead-germanium may appear unusual because of the absence of the normal type of eutectic point, it is similar to the diagrams which have been reported for many other binary alloys.<sup>1</sup> It is indeed strikingly like the diagram for the system silicon-tin, as reported by Tamaru<sup>2</sup> working in Tammann's laboratory. Silicon and tin are stated to be consolute when liquid, and the eutectic point is identical with the melting point of tin (233°). There is the same gradual lowering of the melting point of silicon during the addition of large amounts of tin, and the same abrupt slope in the liquidus curve for the tin-rich alloys. The resemblance between the systems silicon-tin and germanium-lead is complete.

Germanium was found to have properties intermediate between silicon and tin in the alloys with silver. The same is true of the lead alloys. Tamaru<sup>3</sup> has shown that silicon and lead are substantially immiscible, not only as solids, but also as liquids just above the melting point of silicon (circa 1400°). Germanium and lead are immiscible in the solid, germanium is insoluble in lead at the melting point of the latter, but lead is soluble in liquid germanium. Tin is soluble in liquid lead and lead is soluble in liquid tin, there is limited miscibility in the solid state, and there is a normal eutectic point involving the two conjugate solid solutions. There are thus two liquid layers in the system silicon-lead, but none with germanium-lead, or tin-lead; there are solid solutions with tin-lead, but none with germanium-lead or silicon-lead. Miscibility increases greatly as one passes from silicon to germanium, and thence to tin.

The complete similarity between the systems silicon-tin and germanium-lead is particularly interesting. All are members of Group IV and the position

<sup>1</sup> Compare for example the systems: Al-Hg, Al-Sb, Al-Se, Al-Ti, Cu-Bi, Hg-Bi, Ag-Na, Bi-Ni, Si-Sb, Si-Sn, Se-Sn, etc. In the case of the system aluminum-tin, careful investigation has shown that the eutectic is not exactly identical with the melting point of tin (231.7°) but lies at 99.52 per cent tin and 228.7°. Cf. Gwyer: *Z. anorg. Chem.*, 49, 315 (1906).

<sup>2</sup> *Z. anorg. Chem.*, 61, 40 (1909).

<sup>3</sup> *Z. anorg. Chem.*, 61, 42 (1909).

of silicon with reference to tin is practically identical with that of germanium with reference to lead. This symmetrical relationship, while apparently not general in other groups in the Periodic Table, is suggestive, and makes a study of the systems germanium-silicon and germanium-tin well worth while. A series of solid solutions may be expected between silicon and germanium; the behavior of germanium and tin is not readily predictable, except that, as neighbors in a group, they will not form a compound.

#### Summary

- (1) The equilibrium diagram for the system lead-germanium has been worked out by thermal analysis corroborated by optical examination.
- (2) Germanium and lead are probably consolute as liquids, and form no solid solutions. On cooling the liquid alloys, the germanium separates completely before any of the lead leaves the solution. The usual type of eutectic point is therefore absent.
- (3) Germanium is intermediate between silicon and tin in the alloys with lead. Miscibility with lead increases in the order silicon < germanium < tin, quite as one would expect from the position of these metals in the same group in the Periodic System.
- (4) The systems lead-germanium and tin-silicon are completely similar, suggesting a not-unexpected symmetrical relationship between similarly placed metals in the same group in the Periodic System.

*Cornell University,  
July, 1929.*

## THE REDUCTION OF ALKALI NITRATES BY HYDROUS FERROUS OXIDE

BY S. H. CARSLY

O. Baudisch, P. Mayer and L. Welo<sup>1</sup> in a series of papers have shown that a large variation in the amount of ammonia is obtained when alkali nitrates are reduced by hydrous ferrous oxide. Their results showed that a neutral solution containing ferrous oxide, produced by the action of sodium hydroxide on ferrous sulphate, when boiled with sodium nitrate, reduced it quantitatively to ammonia. If, however, the solution was first boiled to expel any dissolved oxygen and the nitrate added afterwards, no ammonia was produced and no reduction took place.

When excess sodium hydroxide is present, the reduction in the presence of oxygen decreases, reaching a minimum at 6.67% alkali with only 4.5% reduction to ammonia. On increasing the alkali concentration the reduction increases both in the presence and absence of oxygen. At 28% alkali the reduction is quantitative to ammonia. In the absence of oxygen and with sodium nitrate in solution freshly precipitated ferrous oxide gave no reduction even on boiling and did not seem to change in any visible manner.

Certain organic compounds such as lactic and cinnamic acids were found to be oxidized by freshly precipitated ferrous oxide in the presence of dissolved oxygen. On the other hand ferrous oxide that had aged over eight hours, or freshly precipitated oxide in the absence of oxygen produced no oxidation.

From these and other results it was concluded that ferrous oxide does not reduce nitrates. If oxygen is present, a peroxide of iron forms, corresponding to  $\text{FeO}_2$ .

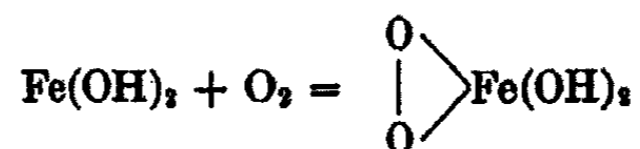

The ferrous hydroxide peroxide reacts with the nitrate to split off oxygen and give a nitrite.  $\text{FeO}_2(\text{OH})_2 + 2 \text{NaNO}_3 \rightarrow \text{FeO}_2\text{H}_2 + 2\text{NaNO}_2 + 2\text{O}_2$ . Nitrite had been found to react with ferrous oxide in the absence of oxygen. The nitrite therefore is then reduced to ammonia by the ferrous oxide present.

To account for the decrease in the amount of reduction in the presence of alkali the reaction



was said most likely to take place, and so prevent the formation of a peroxide, which in turn would cut down the reduction of nitrate.

<sup>1</sup> Baudisch and Mayer: *Biochem. Z.*, 107 (1920); Baudisch: *Ber.*, 54B, 406-13 (1921); Baudisch and Welo: *J. Biol. Chem.*, 61, 261; 64, 755 (1924).

Both these explanations are very unsatisfactory. The generally accepted mechanism for the oxidation of hydrous ferrous oxide by oxygen is first the formation of black, magnetic, ferroferric oxide (magnetite) which is then further oxidized to red ferric oxide.

From the experiments of Hale<sup>1</sup> it is known that the higher oxide would not be FeO<sub>2</sub> but Fe<sub>2</sub>O<sub>4</sub>; but this is merely a matter of detail. There is no evidence that the instable oxide would react with sodium nitrate to give nitrite, and the whole thing is superfluous anyhow, because hydrous ferric oxide will reduce nitrate direct. It is possible, however, that oxygen has a slight and indirect peptizing action on agglomerated ferrous oxide. That would save Baudisch's face and is not impossible.

In the case where no reduction took place in the absence of oxygen, the ferrous oxide was actually precipitated in the presence of dissolved oxygen and then boiled to expel air. Therefore if a peroxide does form when oxygen is present it must have been formed in the case where no reduction was obtained.

Baudisch states that ferrous oxide peroxide is magnetic. Just how he differentiated it from strongly magnetic ferroferric oxide which is known to be present is not clearly shown.

The supposition of the reaction



taking place in alkaline solution is not well founded. No reference in the literature could be found to show that sodium hydroxide and ferrous oxide do react. de Schulten<sup>2</sup> has shown that in a hot concentrated solution of sodium hydroxide ferrous oxide is soluble and he has crystallized out the monohydrate of ferrous oxide. However, in concentration up to 28% alkali ferrous oxide is insoluble. If this reaction can take place to the extent that at less than 1% alkali the reduction is cut down to less than 20%, how then is it that at 28% alkali, when the conditions are such as would tend to increase the reaction, 100% reduction is obtained?

At the suggestion of Professor Bancroft, some experiments were made to find out what the facts really were.

#### Experimental

While carrying out some qualitative tests, it was observed that ferrous oxide when boiled with sodium nitrate did not become oxidized to red ferric oxide. The precipitate was black, highly magnetic, and did not seem to alter on being exposed to air. To ascertain if nitrate only oxidizes ferrous oxide to the ferroferric stage it was decided to get the ratio of the ammonia produced to the ferrous oxide consumed, and the amount of ferrous iron present after oxidation had occurred.

<sup>1</sup> J. Phys. Chem., 33, 1633 (1929).

<sup>2</sup> de Schulten: Compt. rend., 109, 266 (1889).

With nitrate reducing to ammonia and ferrous oxide going to the ferric condition the reaction would be represented by,

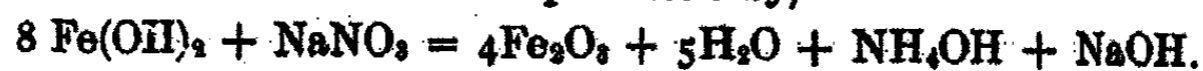

If the oxidation is only to the ferroferric stage the reaction would be,

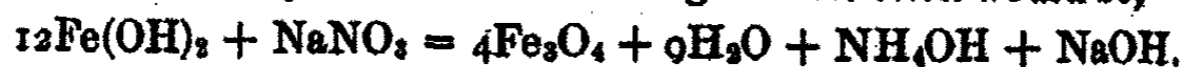

In this case 24 cc. 1N  $\text{Fe(OH)}_2$  will reduce 20 cc. N/10  $\text{NaNO}_3$  to  $\text{NH}_4\text{OH}$ .

The apparatus used consisted of a 500 cc. flask closed by a rubber stopper into which fitted three glass tubes. One tube was for introducing nitrogen, one for introducing solutions and the third connected to a short condenser. The other end of the condenser dipped into a conical flask containing 25 cc. N/10  $\text{H}_2\text{SO}_4$  for collecting the distilled ammonia, 100 cc. of solution containing 30 cc. N/10  $\text{NaNO}_3$  and 53 cc. 1N  $\text{NaOH}$  were placed in the 500 cc. flask and boiled so as to expel all air from the apparatus. Nitrogen was passed slowly through to prevent any air being sucked into the apparatus through the condenser.

Approximately 200 cc. of hot solution containing exactly 24 cc. 1N  $\text{FeSO}_4$  and 5 cc. 1N  $\text{H}_2\text{SO}_4$  to prevent hydrolysis, were run into the alkali solution in the absence of oxygen. In making up the ferrous sulphate solution the distilled water was first boiled to drive out any oxygen, whereupon acid and solid ferrous sulphate added and the normality was estimated by titrating with N/10  $\text{KMnO}_4$ .

A white flocculent precipitate of ferrous oxide formed, which turned green immediately and black gradually, due to oxidation. The solution was boiled for two and a half hours when approximately 200 cc. distilled over into the conical flask.

The distillate was removed and a flask containing water substituted. The iron oxide solution was cooled and 75 cc. con.  $\text{H}_2\text{SO}_4$  added slowly. After boiling for twenty minutes all the iron oxide dissolved and the remaining nitrate reduced to NO.

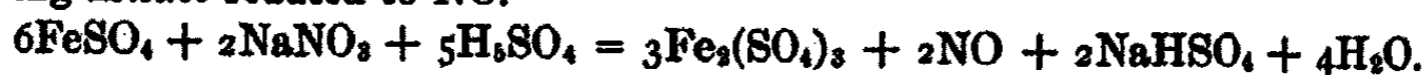

Titration for ferrous iron with N/10  $\text{KMnO}_4$  gave 49.1 cc. Titration for ammonia with  $\text{NaOH}$  gave 19.86 cc. N/10  $\text{NH}_4\text{OH}$ .

#### Calculations.

140.00 cc. N/10  $\text{FeO(H}_2\text{O)Aq}$ .

49.10 cc. Titrated

190.90 cc.

158.88 cc. To reduce  $\text{NaNO}_3$  to  $\text{NH}_4\text{OH}$ .  $19.86 \times 8 = 158.88$

32.02 cc.

30.00

30.42 cc.

19.86

To reduce  $\text{NaNO}_3$  to NO

1.60 cc.

$10.14 \times 3 = 30.42$



The unaccounted-for 1.6 cc. of ferrous iron is no doubt due to oxidation from air, which to some extent must have taken place during the experiment. The ratio of the ammonia produced to the ferrous oxide used is quantitative for ferrous oxide. It is therefore concluded that ferrous oxide reduces nitrate quantitatively to ammonia, and is itself oxidized to black, magnetic, ferrous oxide.

To find out what effect oxygen has on the yield of ammonia five experiments were performed under the same conditions except that the amount of initial oxidation varied.

300 cc. solution containing 30 cc. N/10 NaNO<sub>3</sub>, 48 cc. 1N NaOH and 24 cc. 1N FeSO<sub>4</sub>. Distilled for two and a half hours.

(1) Shook in the presence of air and then distilled. Solution green at start. Titrated 18.76 cc. N/10 NH<sub>4</sub>OH. Reduction 93.8%.

(2) Bubbled air through for ten minutes and then distilled. Solution green at start. Titrated 17.79 cc. N/10 NH<sub>4</sub>OH. Reduction 88.95%.

(3) Bubbled air through for twenty minutes and then distilled. Solution dark green at start. Titrated 16.17 cc. N/10 NH<sub>4</sub>OH. Reduction 80.85%.

(4) Bubbled air through for forty-five minutes and then distilled. Solution black at start. Titrated 9.25 cc. N/10 NH<sub>4</sub>OH. Reduction 46.25%.

(5) Bubbled air through for sixty minutes and then distilled. Solution black at start. Titrated 6.17 cc. N/10 NH<sub>4</sub>OH. Reduction 30.85%.

The decrease in the amount of reduction of nitrate is proportional to the amount of oxidation by oxygen. The ferrous oxide is oxidized by oxygen to ferrous oxide and ferric oxide and so cuts down the available ferrous oxide.

200 cc. of solution containing 30 cc. N/10 NaNO<sub>3</sub>, 24 cc. 1N FeSO<sub>4</sub> and 48 cc. 1N NaOH were placed in a 300 cc. beaker and covered with a closely-fitting ground-glass stopper. The solution was drawn up in the neck and the stopper closed so as to exclude air. After standing for seven days no gas was found to have collected in the neck. On filtering and distilling for ammonia, the distillate titrated 14.00 cc. N/10 NH<sub>4</sub>OH. Reduction 70%.

A similar solution after being made up was immediately filtered and distilled for ammonia. Titrated 0.12 cc. N/10 NH<sub>4</sub>OH. Reduction 0.51%.

Nitrate is reduced slowly by ferrous oxide at room temperature to ammonia. No initial rapid reduction takes place and no oxygen is given off, thus refuting the possibility of a peroxide reaction.

W. von Zorn<sup>1</sup> states that nitrates at room temperature are reduced by ferrous oxide. Divers and Haga<sup>2</sup> found no reaction occurred between nitrates and ferrous oxide.

<sup>1</sup> W. von Zorn: Ber., 15, 125 (1892).

<sup>2</sup> Divers and Haga: J. Chem. Soc., 47, 364 (1885).

### Reduction in Neutral Solution

300 cc. solution containing 0.3 grams  $\text{NaNO}_3$ , 48 cc. 1N  $\text{NaOH}$  and 24 cc. 1N  $\text{FeSO}_4$ . Distilled for two hours. Titrated 19.2 cc. N/10  $\text{NH}_4\text{OH}$ . Reduction 96%.

300 cc. solution containing 48 cc. 1N  $\text{NaOH}$  and 24 cc. 1N  $\text{FeSO}_4$ . Boiled for one hour and then added 0.3 grams  $\text{NaNO}_3$  in the absence of air. Distilled for two hours. Titrated 0.25 cc. N/10  $\text{NH}_4\text{OH}$ . Reduction 1.2%.

300 cc. solution containing 48 cc. 1N  $\text{NaOH}$  and 24 cc. 1N  $\text{FeSO}_4$ . Boiled for one hour. The flask was then disconnected and the solution exposed to air for three hours with intermittent shaking. Distilled for two hours. Titrated 0.2 cc. N/10  $\text{NH}_4\text{OH}$ . Reduction 1%.

As Baudisch and Welo found no reduction to take place in neutral solution after boiling, and as a reduction of 1% might be due to experimental error, it was decided to extend the time for reduction after boiling.

300 cc. solution containing 48 cc. 1N  $\text{NaOH}$  and 24 cc. 1N  $\text{FeSO}_4$ . Boiled for one hour and then added 0.3 grams  $\text{NaNO}_3$  in the absence of air. Boiled continuously for eight days using a reflux condenser. Air was prevented from entering the apparatus, as the condenser dipped into N/10  $\text{H}_2\text{SO}_4$  for collecting the distilled ammonia. Finally, to distil over all ammonia the water was turned off in the condenser and 100 cc. distilled over. Titrated 18.8 cc. N/10  $\text{NH}_4\text{OH}$ . Reduction 94%.

Boiling ferrous oxide before adding nitrate does not prevent reduction, but does reduce very appreciably the rate at which reduction takes place. The presence of oxygen in no way affects the reduction other than to cause some oxidation and so decrease the amount of reduction to some extent.

To compare the relative amount of nitrate reduced at different concentrations of alkali by freshly precipitated ferrous oxide, a series of experiments was performed under otherwise same conditions but with the amount of free alkali varied. The data are given in Table I.

TABLE I

300 cc. solution containing 30 cc. N/10  $\text{NaNO}_3$ , 48 cc. 1N  $\text{NaOH}$  and 24 cc. 1N  $\text{FeSO}_4$ . Free alkali 0-27%. Distilled for one and a half hours and titrated for ammonia.

% free alkali	cc. N/10 $\text{NH}_4\text{OH}$	% reduction	% free alkali	cc. N/10 $\text{NH}_4\text{OH}$	% reduction
0	19.20	96.0	10	1.48	7.4
1/2	6.04	30.2	15	2.74	13.7
1	1.96	9.8	20	5.64	28.2
2	1.62	8.1	27	19.6	98.0
5	1.45	7.3			

As 150 cc. distilled over in one and a half hours the concentration of alkali was based on the final concentration and not at the start when it was only half the final concentration.

To show the effect of boiling ferrous oxide before reducing nitrate a similar series of runs was carried out with the ferrous oxide initially boiled. 300 cc. solution containing 48 cc. 1N NaOH and 24 cc. 1N FeSO<sub>4</sub>. Free alkali 0-27%. After boiling for one hour 0.3 grams NaNO<sub>3</sub> were added in the absence of air and the solution distilled for one and a half hours, Table II. The results of the two tables are shown graphically in Fig. 1.

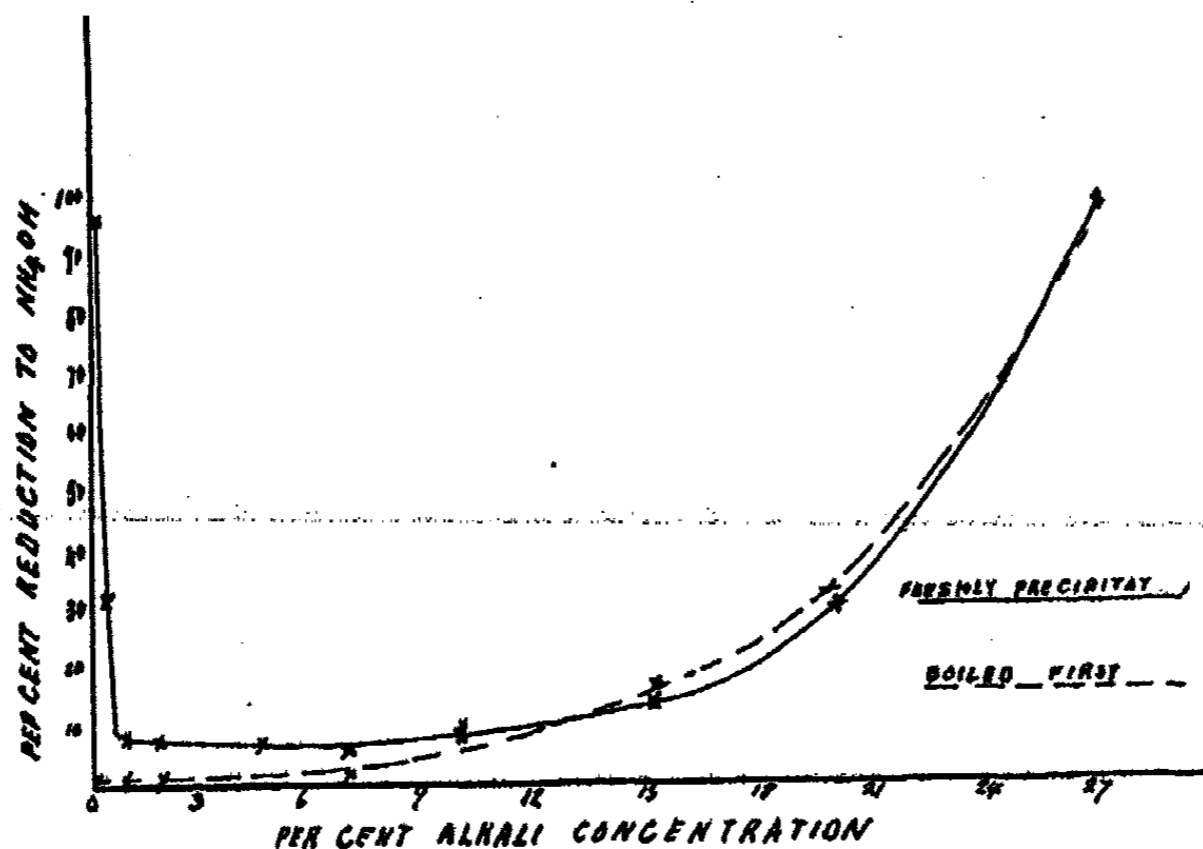

FIG. 1

TABLE II

% free alkali	cc. N/10 NH <sub>4</sub> OH	% reduction	% free alkali	cc. N/10 NH <sub>4</sub> OH	% reduction
0	0.24	1.2	10	2.10	10.5
1	0.28	1.4	15	3.36	16.8
2	0.18	0.9	20	6.52	32.6
7	0.92	4.6	27	19.4	97.0

From neutral to 7% alkali, boiling the ferrous oxide reduces the reduction in all cases to less than 5%. From 7% to 27% the initial boiling does not seem to affect materially the amount of reduction. If the relative amount of reduction under the different conditions depends upon the amount of hydration and coagulation of the ferrous oxide particles, then the rate at which they will settle should show a relative variation.

#### Rate of Settling for Ferrous Oxide Particles

To show the relative amount of coagulation in different alkali concentrations for freshly precipitated and boiled ferrous oxide, the rate at which the particles settled was measured.

A cylinder 17.5 cm. high and 2.7 cm. diameter with a volume of 100 cc. was used to hold the solution.

The solution consisted of 100 cc. containing 12 cc. 1N  $\text{FeSO}_4$  and 24 cc. 1N  $\text{NaOH}$  with free alkali from 0-27%. After mixing, the precipitated ferrous oxide solution was shaken well and allowed to stand. The time for the ferrous oxide particles to fall 10 cm. was then observed. The data are given in Table III and in Fig. 2.

TABLE III  
Freshly precipitated ferrous oxide

% alkali	time in minutes to fall 10 cm.	% alkali	time in minutes to fall 10 cm.	% alkali	time in minutes to fall 10 cm.
0	82	3	15	7	11
1/2	27	4	14	11	8
1	22	5	14	15	10
2	16	6	12		

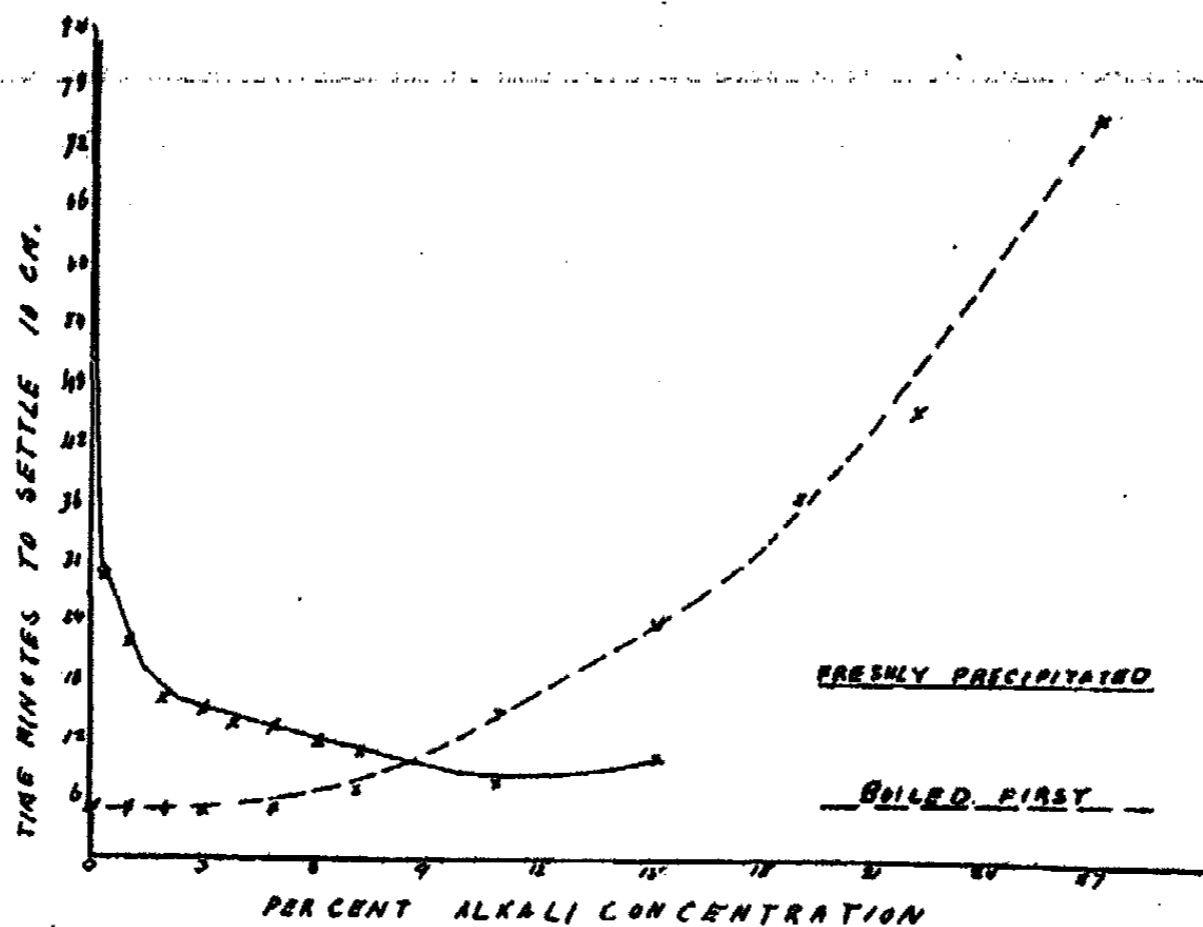

FIG. 2

After 15% alkali the ferrous oxide did not settle out but formed a layer at the top, and therefore no more measurements were possible. From 16% to 27% alkali some of the freshly precipitated oxide coagulated into large loose masses and settled out very rapidly. The ferrous oxide which did not coagulate remained suspended for over twelve hours. The amount of suspended oxide was relatively greater the higher the concentration of alkali.

The coagulating effect of boiling was measured in a similar manner. The solution was boiled for one hour in a conical flask closed with a rubber stopper containing a small glass tube. The solution was then poured into the cylinder and allowed to settle, Table IV.

TABLE IV

% alkali	time in minutes to fall 10 cm.	Boiled ferrous oxide			
		% alkali	time in minutes to fall 10 cm.	% alkali	time in minutes to fall 10 cm.
0	5	7	7	19	37
1	5	11	15	23	45
3	5	15	25	27	76
5	5				

In hot concentrated sodium hydroxide solution ferrous oxide is soluble and from it the monohydrate of ferrous oxide has been crystallized.<sup>1</sup> No reference in the literature can be found where a reaction takes place between sodium hydroxide and ferrous oxide. Ferric oxide is soluble in hot concentrated sodium hydroxide, and forms a ferrite  $\text{NaFeO}_2$ .<sup>2</sup> However, in hot sodium hydroxide up to 27% both ferrous and ferric oxide were found to be insoluble. If nitrate oxidizes ferrous oxide to ferric oxide to form a ferrite, then 24 cc. 1N ferrous oxide should reduce nitrate to give 30 cc. N/10  $\text{NH}_4\text{OH}$ . On reducing nitrate in 27% alkali solution with 24 cc. 1N ferrous oxide there was obtained 20 cc. N/10  $\text{NH}_4\text{OH}$ . This is equivalent 100% reduction for ferrous oxide and 66 2/3% for ferric oxide. The oxidized ferrous oxide is black and strongly magnetic, and it is therefore concluded that the same reactions take place as in neutral and dilute alkali solutions. Nitrate is reduced to ammonia and the ferrous oxide oxidized to ferrous ferric oxide.

To show that the relative amount of reduction can be changed and depends only upon the concentration of alkali, reduction was carried out so that the alkali concentration was varied after the initial precipitation and boiling.

300 cc. solution containing 48 cc. 1N  $\text{NaOH}$  and 24 cc. 1N  $\text{FeSO}_4$ . Boiled for one hour and then added 0.3 grams  $\text{NaNO}_3$ . Distilled for one and a half hours. Titrated 0.24 cc. N/10  $\text{NH}_4\text{OH}$ . Reduction 1.2%.

300 cc. solution containing 48 cc. 1N  $\text{NaOH}$  and 24 cc. 1N  $\text{FeSO}_4$ . Boiled for one hour. Allowed the precipitate to settle and then decanted off the water. Added 0.3 grams  $\text{NaNO}_3$  and made solution up to 300 cc. with 27% alkali. Distilled for one and a half hours. Titrated 18.6 cc. N/10  $\text{NH}_4\text{OH}$ . Reduction 93%.

300 cc. solution containing 24 cc. 1N  $\text{FeSO}_4$  and 27% alkali. Boiled for one hour. Added 0.3 grams  $\text{NaNO}_3$  and distilled for one and a half hours. Titrated 19.6 N/10  $\text{NH}_4\text{OH}$ . Reduction 98%.

300 cc. solution containing 24 cc. 1N  $\text{FeSO}_4$  and 27% alkali. Boiled for one hour. Allowed the ferrous oxide to settle. Decanted off alkali. Washed the precipitate twice with water. Added 0.3 grams  $\text{NaNO}_3$  and made the solution up to 300 cc. with distilled water. Distilled for one and a half hours. Titrated 0.20 cc. N/10  $\text{NH}_4\text{OH}$ . Reduction 1%.

<sup>1</sup> de Schulten: Compt. rend., 109, 266 (1889).

Schönigotsch: Pogg. Ann., 43, 117 (1837).

The coagulation of ferrous oxide particles may be very strikingly illustrated as follows. Ferrous oxide precipitated in 27% alkali is boiled and then allowed to settle, which takes in the neighborhood of two hours. The alkali solution is then decanted and the solution diluted with water. After being thoroughly shaken the ferrous oxide particles will be seen immediately to coagulate and settle out in a few minutes.

Samples of freshly precipitated and boiled ferrous oxide from neutral and strongly alkaline solutions were examined under the microscope. Using high magnification, 32 mm. objective and No. 1 eyepiece, with the dark field illuminator the particles in all cases were very minute and gave diffraction patterns. Slow Brownian movement was observed by those particles which had not been coagulated. The relative size of the particles did not seem to vary greatly in the different samples. As the particle size was so small it was impossible to make any estimation of the relative amount of coagulation.

#### Theoretical Discussion

Several theories have been advanced to account for the manner in which water is retained by hydrous oxides. Among those most generally supported may be mentioned; the formation of a solid solution; cellular or honeycomb system; formation of an emulsion; and the micellar theory. The present opinion of the majority of investigators is towards the view that hydrous oxides are two-phase solid-liquid systems in which there is a net-work of solid phase permeated by a liquid.

Ferric oxide, obtained by precipitating a ferric salt with alkali, forms as a very bulky mass which can be dehydrated by boiling.<sup>1</sup> Similarly freshly formed hydrous cupric oxide loses water on heating.<sup>2</sup> Cuprous oxide on heating dehydrates and is then much less reactive towards oxygen. Its solubility in alkalis and acids is likewise greatly reduced. If alkali is added to a cobaltous salt a hydrous mass is thrown down which gives up water on heating.<sup>3</sup>

The literature is very meager on hydrous ferrous oxide, and dehydration on boiling does not seem to have been investigated.

As the rate of settling for ferrous oxide in neutral and dilute alkali solutions has been found to be greatly increased by boiling, it is reasonable to attribute this to dehydration and coagulation of the particles. With the particles coagulated by boiling, the reduction of nitrates would be slower owing to a great decrease in surface and the formation of an oxidized coating on the agglomerated particles.

The presence of excess alkali causes the ferrous oxide to precipitate in a denser mass than in neutral solution. The settling rate for freshly precipitated ferrous oxide has been shown to increase with free alkali in dilute solutions

<sup>1</sup> Davies: J. Chem. Soc., 19, 71 (1866).

<sup>2</sup> Spring: Z. anorg. Chem., 2, 195 (1892).

<sup>3</sup> Hantzsch: Z. anorg. Chem., 73, 304 (1911).

up to 7%. The reduction of nitrate falls off with increased alkali due no doubt to the denser form coagulating before complete oxidation of the ferrous oxide can occur.

In concentrated alkali from 7% to 27% previously boiling ferrous oxide does not seem to have any marked effect on the amount of reduction of nitrate. Boiling ferrous oxide in strong alkali must have a peptizing action on ferrous oxide. In this case freshly precipitated and previously boiled ferrous oxide should, as has been found, reduce approximately the same amount of nitrate. If strong alkali loosens up the coagulated particles the rate of settling should be slower and the reduction of nitrate increased. This is precisely what happened, and that ferrous oxide previously boiled only gave 2% reduction when on adding 27% alkali 93% reduction took place is in entire agreement with the fact that strong alkali peptizes ferrous oxide.

#### Summary

1. Hydrous ferrous oxide reduces nitrate quantitatively to ammonia, and is itself oxidized to black, magnetic, ferroferric oxide.

2. In neutral and dilute solutions, previously boiled ferrous oxide reduces nitrate much more slowly than does the freshly precipitated ferrous oxide. The difference is due to the boiled ferrous oxide having agglomerated and lost water.

3. Ferrous oxide tends to precipitate in a denser, more agglomerated form in dilute alkali than in a neutral solution.

4. Boiling ferrous oxide in strong alkali gives rise to a partial peptization, which makes it possible for the ferrous oxide to reduce the nitrate rapidly.

5. Baudisch overlooked the agglomeration of the ferrous oxide and its effect on the rate of reduction and consequently his conclusions are wrong, though his experimental data are right. He was changing two variables simultaneously, the alkalinity and the degree of agglomeration; but he tried to account for his results on the assumption of the degree of alkalinity being the only variable.

6. While the action of oxygen on ferrous oxide does result in the temporary formation of an unstable, higher oxide, the higher oxide is  $\text{Fe}_2\text{O}_4$  and not  $\text{FeO}_3$ , as Baudisch assumed. There is no experimental evidence that either  $\text{Fe}_2\text{O}_4$  or  $\text{FeO}_3$  would react with sodium nitrate to form sodium nitrite, oxygen, and any oxide of iron. This was an assumption which Baudisch should have supported by some independent evidence.

7. If the reaction of oxygen with ferrous oxide causes a peptization of the ferrous oxide, this would account for the results obtained by Baudisch: but there is as yet no independent evidence that this actually happens.

*Cornell University,  
June, 1928.*

## THE POLYMORPHISM OF SODIUM SULFATE: III. DILATOMETER INVESTIGATIONS

BY F. C. KRACEK AND R. E. GIBSON

### Introduction

In a recent study Kracek<sup>1</sup> demonstrated that the numerous breaks in the temperature-time curves obtained when samples of pure anhydrous sodium sulfate are heated and cooled may be accounted for by the hypothesis that this salt has five polymorphic forms between 180° and 260°C. These modifications were labeled by Roman numerals from Na<sub>2</sub>SO<sub>4</sub>I, the variety which crystallizes from the molten salt, to Na<sub>2</sub>SO<sub>4</sub>V or thenardite, the form which appears from aqueous solutions.

The foregoing investigation suggested several problems which might be solved with the aid of a dilatometer and which will now be outlined.

The inversions of sodium sulfate fall into two distinct groups—the *lower* inversions which cluster around 200° and are in general irreversible or pseudomonotropic in the dry salt, and the *upper* inversions which occur about 240° and appear to be reversible. An important consequence of the pseudomonotropic nature of the *lower* inversions is that sodium sulfate is permanently altered physically by being heated to 200° and hence that two varieties of the salt exist at room temperature, viz. Na<sub>2</sub>SO<sub>4</sub>V and Na<sub>2</sub>SO<sub>4</sub>III. Measurements of optical properties<sup>2</sup> and densities<sup>3</sup> have confirmed these conclusions but at the time these experiments were begun there was still a doubt as to which was the stable form at room temperature.

All the transformations which Kracek observed were marked by superheating to a greater or less degree and so it was impossible to estimate the temperatures with any degree of precision. It was of interest to attempt to reduce the width of the hysteresis loops and to fix more closely the equilibrium temperature of the various transitions. A problem closely allied with this one was an investigation of the promptitude and speed of each inversion. In addition we were interested in the sign and magnitude of the volume changes accompanying each change of phase.

At the outset it was discovered that an ordinary glass dilatometer with mercury as index liquid could not be used in a study of the *lower* inversions, as it was found impossible to prepare from solution crystals of Na<sub>2</sub>SO<sub>4</sub> which were entirely free from microscopic cavities including solution. All attempts to remove the water from these cavities below 150° were abortive, and only when the crystals started to invert in the dilatometer were the last traces of

<sup>1</sup> J. Phys. Chem., 33, 1281 (1929).

<sup>2</sup> References are summarized in the first paper of this series.

<sup>3</sup> Kracek and Gibson: J. Phys. Chem., 33, 1304 (1929).



water evolved. One sample of  $\text{Na}_2\text{SO}_4$ , a part of which lost only 0.1 per cent of water on ignition, produced sufficient steam in the dilatometer to distribute the confining liquid violently over the surroundings. Indeed, a sample which contained so little occluded moisture that 10 grams lost less than 0.1 mg. on heating to  $300^\circ$ , contained enough to cause a large anomalous expansion. We were therefore led to use an apparatus in which the transformations could be carried on under a pressure of fifty megabaryes—a pressure sufficient to keep any water present in the liquid state below  $270^\circ$ . Although drying the salt above  $200^\circ$  spoils it for investigations of the *lower* inversions this treatment does not affect the *upper* inversions, and so it was comparatively simple to prepare samples of  $\text{Na}_2\text{SO}_4$  by ignition at about  $400^\circ$  which were suitable for examination of the upper inversions in an ordinary glass dilatometer.

It has been suggested<sup>1</sup> that the speed and promptitude of these polymorphic changes might be enhanced by the presence of water. The pressure dilatometer provided a means of studying the influence of water on all the transformations, and we were able to reverse the *lower* inversions at will.

In this article we hope to add to our knowledge of the polymorphism of sodium sulfate:

1. More accurate values of the various inversion temperatures.
2. Conditions under which the *lower* inversions proceed reversibly.
3. The effect of water on the speed and promptitude of the transformations.
4. The stability relations of the various phases.
5. The sign and approximate magnitude of the volume changes accompanying the various metamorphoses.

#### Experimental

**Apparatus.** It is unnecessary to enlarge upon the glass dilatometer which is sketched in Fig. 1. It consisted of a wide glass tube closed at the upper end and sealed at the lower end to a capillary tube. Mercury was used as the index liquid and the movement of the meniscus in the capillary was carefully

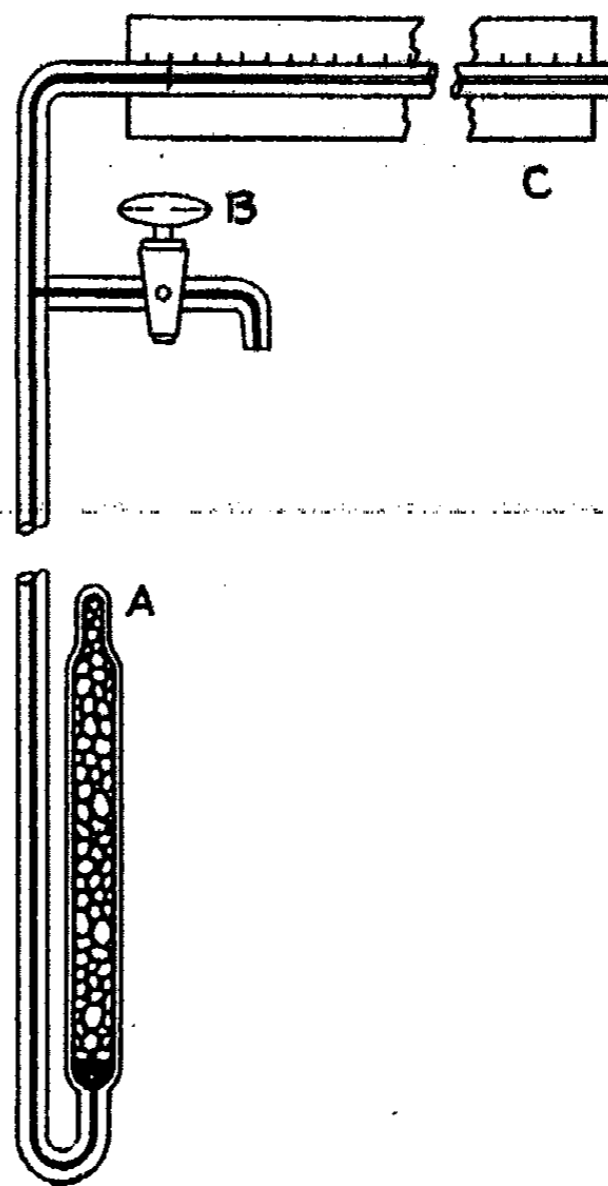

FIG. 1  
Glass dilatometer

<sup>1</sup> Kracek: Op. cit.

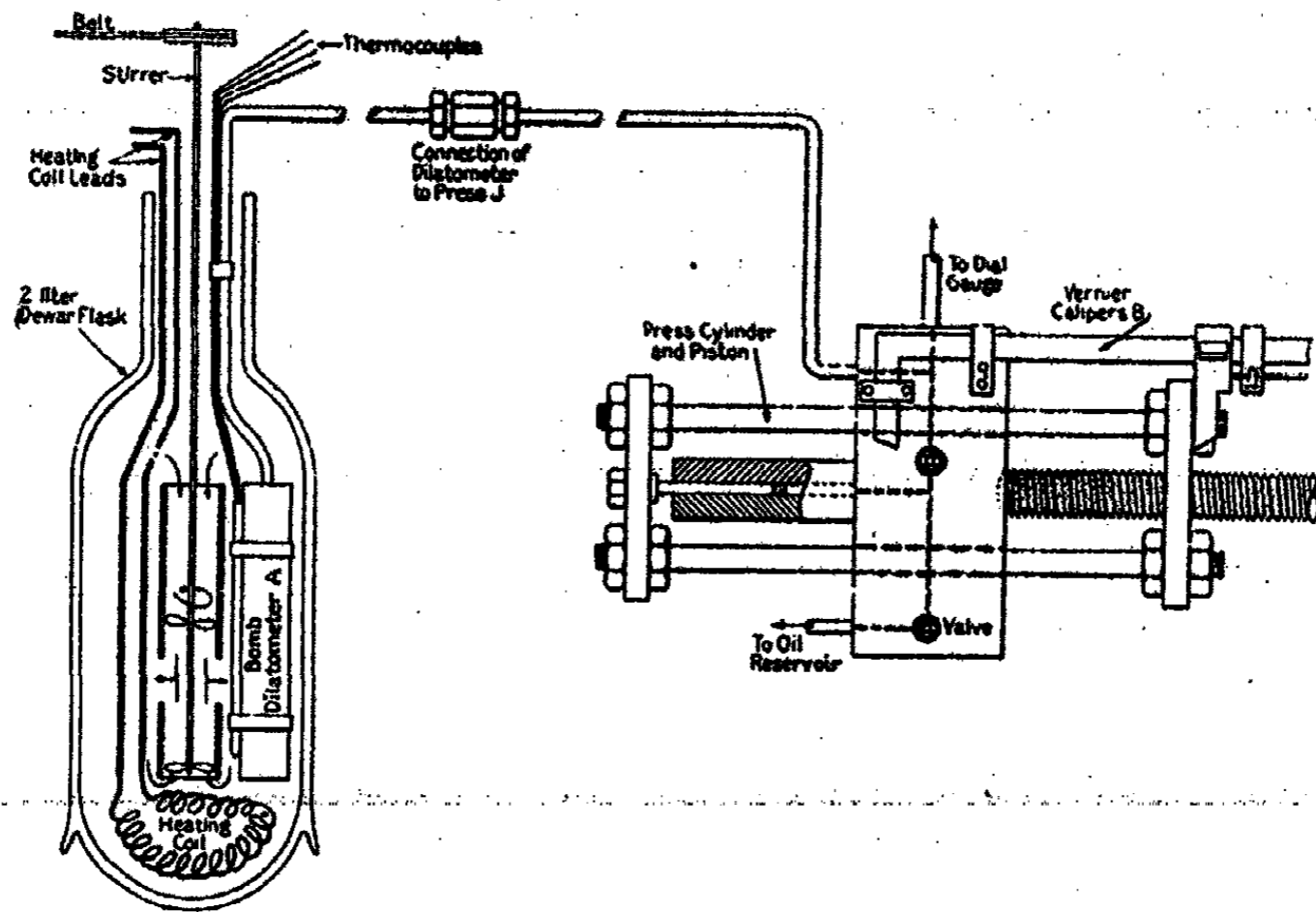

FIG. 2  
Diagrammatic sketch of pressure dilatometer

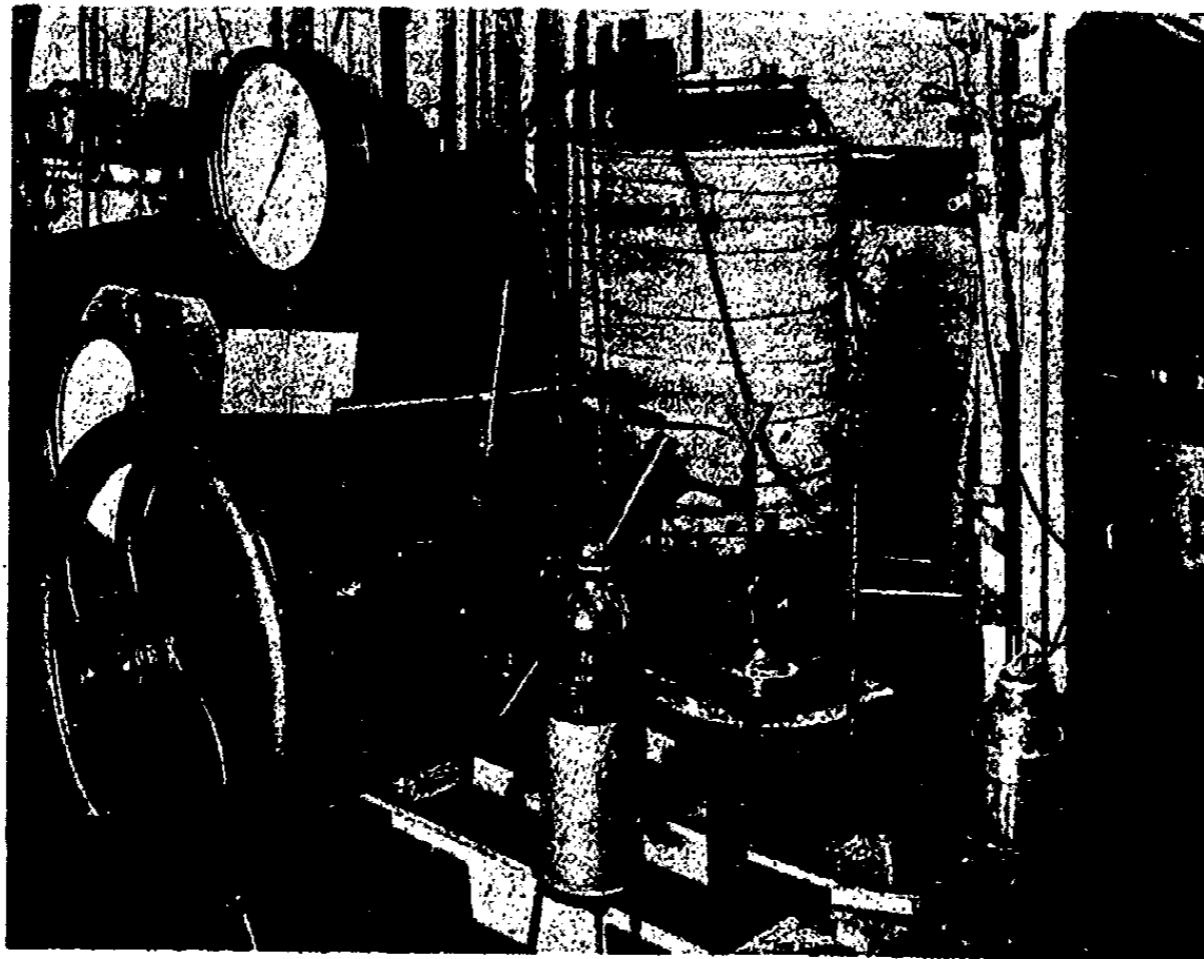

FIG. 3  
Photograph of pressure dilatometer and accessories.

measured. The capillary was calibrated with a weighed thread of Hg. Sodium sulfate was introduced in weighed amounts into the apparatus through the tube *A* which was immediately sealed. The dilatometer was then evacuated and heated to  $250^{\circ}\text{C}$  for an hour after which the mercury was allowed to flow in at *C*. The stopcock *B* permitted the arbitrary adjustment of the mercury meniscus. With this apparatus volume changes of the order of  $0.2 \text{ mm}^3$  could be detected.

The complete assembly of the pressure dilatometer is shown diagrammatically in Fig. 2 and a photograph of the apparatus is given in Fig. 3. The apparatus consisted essentially of a small steel vessel or bomb *A* connected by a fine steel capillary tube to an Amagat press. The travel of the piston in the press was read on the vernier calipers *B* the fixed jaw of which was securely clamped to the body of the press while the movable jaw was brought up against a bar on the piston carriage. As the vernier was graduated to  $0.02 \text{ mm}$  and the cross section area of the cylinder was  $54.5 \text{ mm}^2$ , the volume changes could be estimated to within  $1.1 \text{ mm}^3$ . The bomb was built of case-hardened machine steel and is illustrated in Fig. 4. To close the bomb and render it absolutely leak proof the conical portion of the steel connection was forced into the copper washer which was supported by a horizontal "flat" and the cylindrical wall of the vessel. We have found this combination very effective indeed and with slight modification it can be made to hold absolutely tightly at pressures as high as 15,000 atmospheres. A two-liter Dewar flask filled with highly refined heavy mineral oil served as a heating bath. The flask was fitted with an electrical heater of bare nichrome wire of 25 ohms resistance, a stirrer, and a syphon for adjusting the level of the oil. As there was extremely small lag between the bare heater and the oil we were able to change the temperature promptly and maintain it with ease at any particular value. At higher temperatures it was necessary to keep the mouth

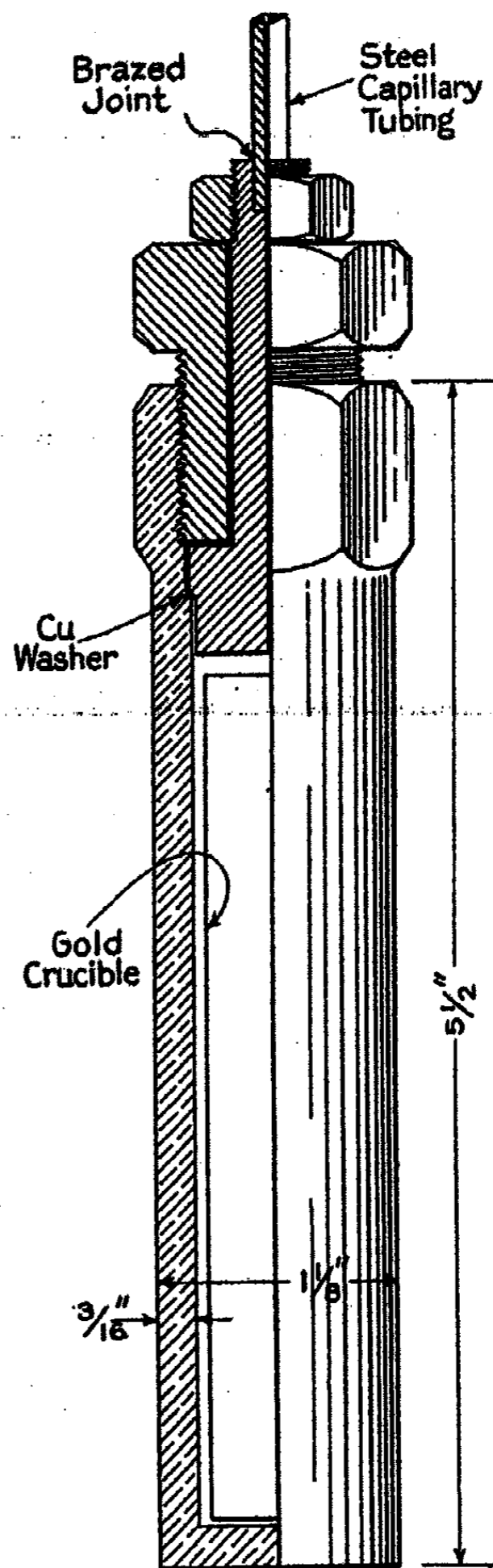

FIG. 4  
Diagram of steel bomb showing detail of packing.

of the flask well plugged to eliminate "flashing" of the oil vapors. We found, however, that plugging with absorbent cotton was sufficient to prevent "flashing" even when the temperature of the oil was 265°.

Two copper-constantan thermocouples were placed in a thin glass tube attached to the bomb. One thermocouple was of the differential type with junctions at the top and at the bottom of the bomb and served to indicate the magnitude of the temperature gradient throughout the bath. When the stirring was rapid this difference between the temperatures of the two junctions never exceeded 0.2°C. The junction of the reading thermocouple was placed midway between the junctions of the differential couple. The thermal E.M.F.'s were read on a potentiometer which has already been described.<sup>1</sup> As the constantan wire was cut from the lot used by Adams<sup>2</sup> in preparing the temperature-E.M.F. tables for copper-constantan elements, it was considered sufficient to check the calibration only at the boiling point of naphthalene (217.95°). By these means we were able to measure the temperature of the bomb and hence of its contents with sufficient accuracy.

The material under investigation was weighed into a gold crucible (Fig. 4), and so introduced into the bomb which was then filled with mineral oil. The contents of the crucible were rendered practically air-free by immersing the salt in oil or solution which had previously been placed in the crucible. The upper plug was fitted and screwed into place so that the oil was forced out through the capillary tube. At the same time care was taken to see that the press and its connections were filled to *J* with the same oil. The bomb was immersed in the oil bath and the capillary connected to the press by the joint *J*. In this way air was eliminated from the apparatus. The temperature was then gradually raised and held constant at appropriate points. At each stop sufficient time was allowed to permit equalization of the temperature throughout. The volume was then adjusted till the pressure gauge read exactly 50 megabaryes and the position of the piston was read on the vernier calipers. It may be mentioned that the system composed of the dilatometer and the pressure gauge made a very sensitive thermometer and when the gauge needle remained steady we were sure that temperature changes taking place inside the bomb did not exceed 0.1°C. The piston displacement was plotted against the temperature to obtain dilatometric curves which will be discussed later.

*Materials.* Purified anhydrous sodium sulfate was recrystallized in the way already described;<sup>3</sup> in fact, Preparation 2 (large crystals of dry neutral Na<sub>2</sub>SO<sub>4</sub>) and Preparation 10 are the same as those bearing these numbers in the paper to which reference has been made.

Preparation 11 was crystallized by slow evaporation from a 0.05N acid solution, and contained 0.4 per cent H<sub>2</sub>SO<sub>4</sub>. The pellets described as Prepara-

<sup>1</sup> W. P. White: *Z. Instrumentenkunde*, 34, 71 (1914).

<sup>2</sup> L. H. Adams: "International Critical Tables," 1, 58.

<sup>3</sup> Kracek: *Op. cit.*

tion 12 were made by compressing the very fine powder obtained by the slow dehydration of  $\text{Na}_2\text{SO}_4 \cdot 7\text{H}_2\text{O}$ . The differential pressure employed in making these pellets exceeded  $5000 \text{ kg/cm}^2$ .

### Results

The experiments fell into three distinct groups according to the nature of the material enclosed in the dilatometer. We shall, therefore, consider first the behavior of dry neutral sodium sulfate, second, the behavior of the salt in contact with its saturated solution, and third, that of sodium sulfate crystallized from the faintly acid solution.

*Temperature-volume curves for dry  $\text{Na}_2\text{SO}_4$ .* (a) *Measurements in the glass dilatometer.* Owing to the experimental difficulties mentioned in the introduction, ignited salt was the only type of preparation which could be in-

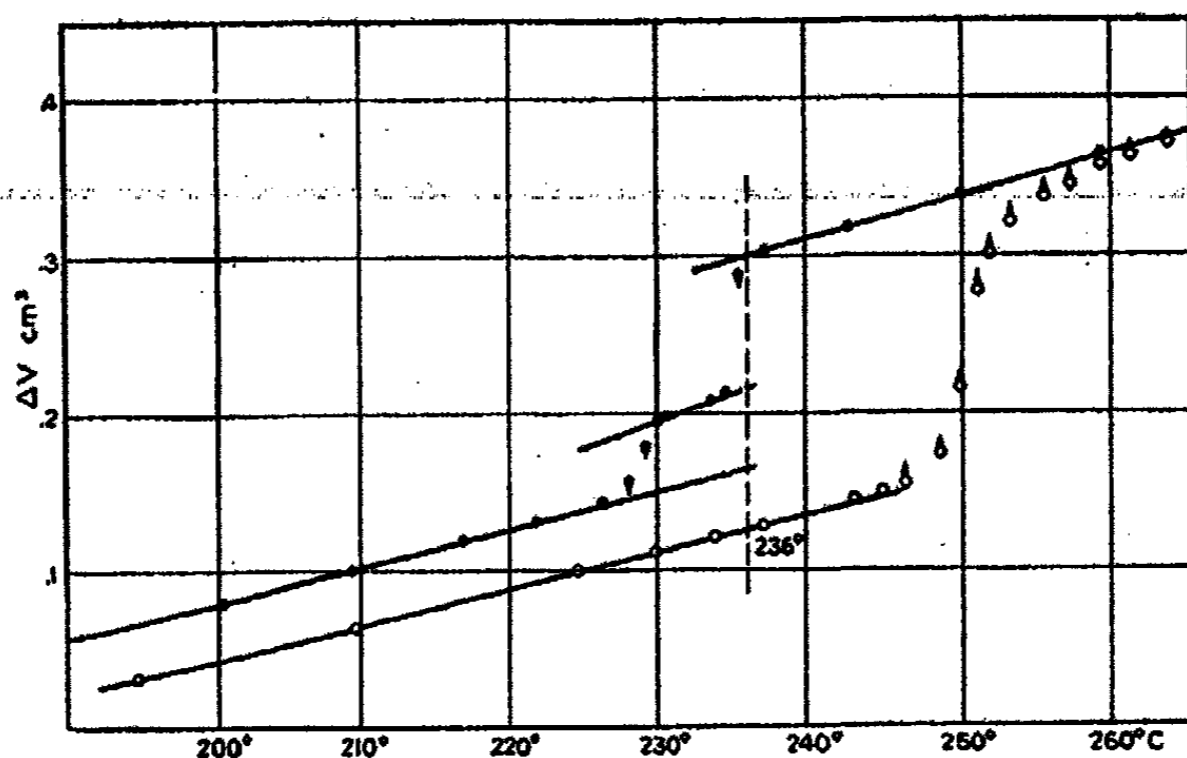

FIG. 5

Temperature-volume curve for dry  $\text{Na}_2\text{SO}_4$  in the neighborhood of the upper inversions. (Glass dilatometer.)

vestigated in an ordinary dilatometer and then only the upper inversions could be studied. As these experiments carried on under atmospheric pressure are of the more conventional type we shall discuss them first. In all of the diagrams that follow, the change in volume from an arbitrary zero is plotted as ordinate with the temperature as abscissa. Readings taken on heating are indicated by open circles which are plain when the readings were absolutely steady and provided with an arrow when the volume change still continued slowly even though the temperature had been held constant for at least fifteen minutes. Points taken on cooling are similarly distinguished but are represented by black dots. Those wishing to know the exact preparation used in each experiment will find the information in Tables I to IV.

The diagram in Fig. 5 represents heating and cooling volume curves for  $\text{Na}_2\text{SO}_4$  in the neighborhood of the upper inversions as observed in the glass dilatometer filled with Preparation 2. Up to  $241^\circ$  the expansion proceeded regularly but beyond this temperature the inversion started and went very

slowly. In the vicinity of  $245^{\circ}$  the volume increased rapidly but not until  $255^{\circ}$ – $260^{\circ}$  was the reaction complete. The time required to complete the change was of the order of one hour. When the apparatus was cooled regular contraction took place until the temperature fell to  $235^{\circ}$ , and then the volume decreased rapidly. This break at  $235^{\circ}$  was one of the most definite and reproducible points we encountered in all the investigation. The volume, however, did not return to its original value at  $235^{\circ}$ , but when slightly over half the expected volume change had occurred the readings ceased to drift at constant temperature, and then not until  $220^{\circ}$ – $230^{\circ}$  did any further abnormal diminution in volume indicate that a change of phase was taking place. At about this temperature the volume again decreased rapidly at first, but then quite slowly, and the cooling curve finally coincided with the heating curve.

Although certain quantitative details of Fig. 5 were not exactly reproducible in all our experiments, the salient features cited above were always present and we would again emphasize the single large change beyond  $241^{\circ}$  on heating and the two changes—the first proceeding sharply at  $235^{\circ}$ , the second between  $220^{\circ}$  and  $230^{\circ}$ —on cooling.

The volume changes accompanying these upper inversions are all positive; that is to say, the high-temperature forms have the larger specific volumes. The magnitude of the volume changes on heating and on cooling are collected in Tables II and IV. Reference to our previous papers<sup>1</sup> shows that ignited  $\text{Na}_2\text{SO}_4$  remains in the form  $\text{Na}_2\text{SO}_4\text{III}$  below the temperatures of the upper inversions; accordingly, we are dealing here with the phase changes  $\text{Na}_2\text{SO}_4\text{III} \rightarrow \text{Na}_2\text{SO}_4\text{I}$ ,  $\text{Na}_2\text{SO}_4\text{I} \rightarrow \text{Na}_2\text{SO}_4\text{II}$  and  $\text{Na}_2\text{SO}_4\text{II} \rightarrow \text{Na}_2\text{SO}_4\text{III}$ . Reversibility experiments (one of which is represented in Fig. 6) indicate that the equilibrium temperature of the I $\rightleftharpoons$ II inversion was  $236^{\circ}$ . In the reversibility experiments the temperature was successively raised and lowered about a certain point and the direction of the volume change was noted at each constant temperature. On the diagram the arrows connect consecutive readings and it will be seen that at  $235^{\circ}$  the I $\rightarrow$ II reaction was proceeding whereas at  $237^{\circ}$  the reverse change was taking place and phase II was passing to phase I.

An interesting reversibility experiment which demonstrated that rather than pass to  $\text{Na}_2\text{SO}_4\text{II}$ ,  $\text{Na}_2\text{SO}_4\text{III}$  will remain inert up to  $241^{\circ}$  and then pass to  $\text{Na}_2\text{SO}_4\text{I}$  is depicted in Fig. 7. The experiment was carried on in the usual way until the break on the cooling curve indicated that the reaction  $\text{Na}_2\text{SO}_4\text{I} \rightarrow \text{Na}_2\text{SO}_4\text{II}$  had begun. At the point A where this reaction was nearly complete the temperature was raised. The path of the curve may be followed by the arrows and shows that the change had reversed at  $237^{\circ}$ , and at  $239^{\circ}$  the reading was back on the original cooling curve. Again the temperature was lowered and at the point B where it was certain the I $\rightarrow$ II inversion was complete but the II $\rightarrow$ III change had not begun, the temperature was again raised. The point at  $238^{\circ}$  shows that again the reaction II $\rightarrow$ I

<sup>1</sup> Kracek: J. Phys. Chem., 33, 1281 (1929); Kracek and Gibson: J. Phys. Chem., 33, 1304 (1929).

was going rapidly. Next time cooling was continued as far as *C* where undoubtedly part of the II→III change had taken place. When the temperature was again raised a certain increase in volume took place but after 239° the curve ran parallel to the original *V-t* curve until at 245° another sharp volume increase brought the reading up to the original cooling curve. The reaction at 237–238° is the inversion of  $\text{Na}_2\text{SO}_4\text{II}$  left unconverted at *C* to  $\text{Na}_2\text{SO}_4\text{I}$ . The reaction at 245–246° is the  $\text{Na}_2\text{SO}_4\text{III} \rightarrow \text{Na}_2\text{SO}_4\text{I}$  transformation which we always find on the heating curves for  $\text{Na}_2\text{SO}_4\text{III}$ . Fig. 7 is in complete agreement with Kracek's reversal experiments<sup>1</sup> and enables

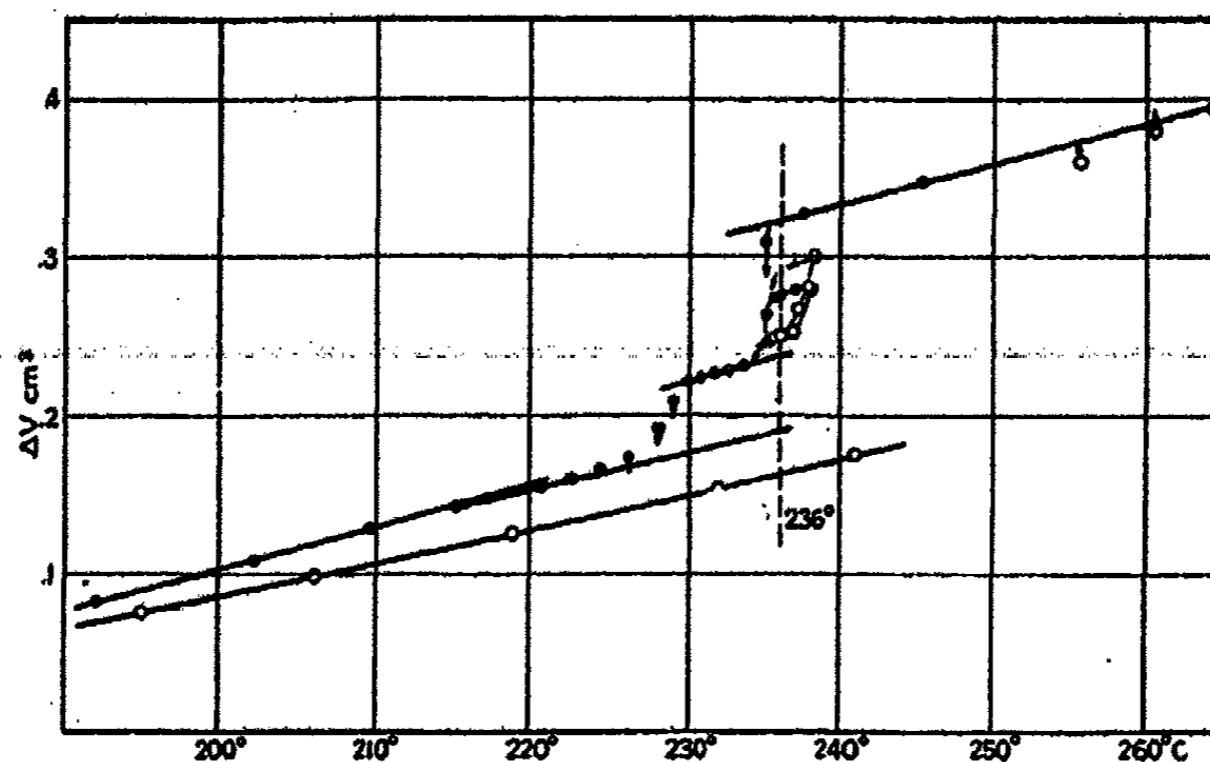

FIG. 6

Temperature-volume curve for dry  $\text{Na}_2\text{SO}_4$  showing the reversibility of the I↔II inversion. (Glass dilatometer.)

us to conclude (a) that the change  $\text{Na}_2\text{SO}_4\text{I} \leftrightarrow \text{Na}_2\text{SO}_4\text{II}$  proceeds promptly and rapidly in both directions and that the change  $\text{Na}_2\text{SO}_4\text{III} \rightarrow \text{Na}_2\text{SO}_4\text{II}$  will not occur in the dry state, but that when  $\text{Na}_2\text{SO}_4\text{III}$  is heated it remains inert until the temperature is high enough for the inversion  $\text{Na}_2\text{SO}_4\text{III} \rightarrow \text{Na}_2\text{SO}_4\text{I}$  to take place. In Fig. 8 we have collected the results of other experiments which show the resemblances and differences which were encountered.

(b) *Measurements in the pressure dilatometer.* In this series of experiments we were able to study all the inversions from 160° to 260°. The first material used was very dry—it was Preparation 2 which had been in an air oven at 110° for two to three months. Microscopic examination revealed that it was thenardite. Fig. 9 gives the complete behavior of this material at a pressure of 50 megabaryes the first time it was heated from 160° to 260°. The small break *A* is identified with the change  $\text{Na}_2\text{SO}_4\text{V} \rightarrow \text{Na}_2\text{SO}_4\text{IV}$ . After this break the curve runs steadily up to 220° when a change of slope is seen. The increase in volume begins beyond 241° and ends at 255–260°. The distribution of the points shows that the reaction was comparatively slow.

<sup>1</sup> Op. cit., p. 1294.

Here we may contrast the heating curve in Fig. 9 with the heating curve for moist  $\text{Na}_2\text{SO}_4$  in Fig. 11. We notice at once that the large volume decrease beyond  $186^\circ$  is absent in Fig. 9 and that the  $241^\circ$  inversion involves less volume change in Fig. 9 than in Fig. 11; in other words the change  $\text{Na}_2\text{SO}_4\text{IV} \rightarrow \text{Na}_2\text{SO}_4\text{III}$  has been delayed in the dry sample until at least  $220$ – $230^\circ$ .

On cooling, the  $236^\circ$  inversion takes place promptly and the usual flattening of the curve is followed by the second volume decrease. The final part of the cooling curve lies below the initial heating curve, a circumstance which is explained by the observation that the phases are not the same on

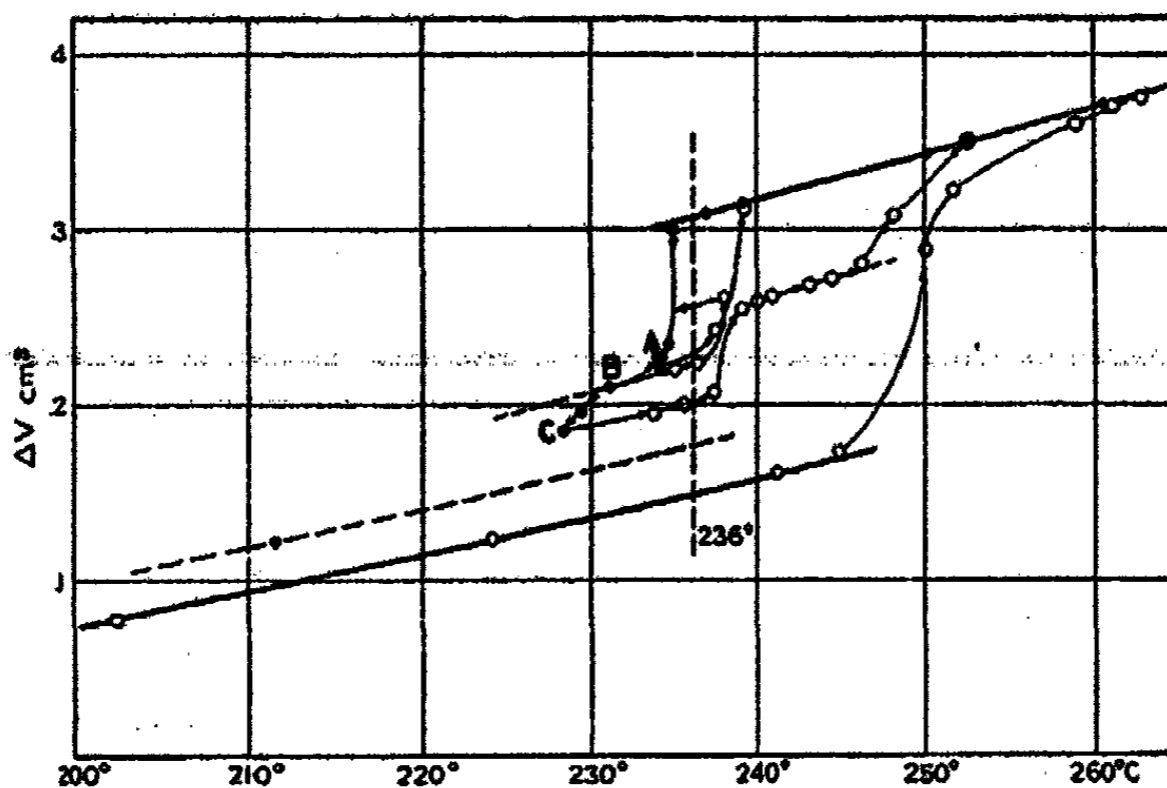

FIG. 7

Temperature-volume curve for dry  $\text{Na}_2\text{SO}_4$  illustrating the reversibility of the I ↔ II inversion and the irreversibility of the II ↔ III inversion. (Glass dilatometer.)

heating and cooling. The heating curve refers to  $\text{Na}_2\text{SO}_4\text{IV}$ ; the cooling curve to the denser  $\text{Na}_2\text{SO}_4\text{III}$ . Microscopic examination at the conclusion of the experiment identified the salt as  $\text{Na}_2\text{SO}_4\text{III}$ .

When the sample was heated a second time the phase in the dilatometer was  $\text{Na}_2\text{SO}_4\text{III}$  and Fig. 10 shows that the volume-temperature curve was absolutely straight from  $195^\circ$  to above  $241^\circ$  when the large volume change occurred. The transformations on cooling were again divided into two parts but the cooling curve fell below the heating curve. This effect was certainly not all due to leakage, but we have been unable to find a satisfactory explanation for it.

The volume changes are summarized in Tables III and IV.

*Volume-temperature curves for  $\text{Na}_2\text{SO}_4$  in contact with its aqueous solution.* The gold crucible was filled within 5 mm of the top with known amounts of coarsely crystalline thenardite and its saturated solution. Mineral oil was added to fill the crucible to the brim. The crucible with its contents was introduced into the bomb of the pressure dilatometer which was also filled with the same oil and closed in the usual way. Fig. 11 shows a heating curve



obtained from this type of experiment. Noteworthy features of this curve are the volume increase at  $186^\circ$ , the large volume decrease at  $195^\circ$ , and the rapidity of the  $241^\circ$  inversion which was all completed at only a little above  $241^\circ$  and required less than fifteen minutes. There are also irregularities between  $220^\circ$  and  $230^\circ$  which are not due to the apparatus, as a comparison with Fig. 10 will show, but which are connected with the metastable inversions.

A detailed study of the lower inversions led to the conclusion that the V $\rightarrow$ IV transition proceeds below  $180^\circ$  and that the equilibrium temperature

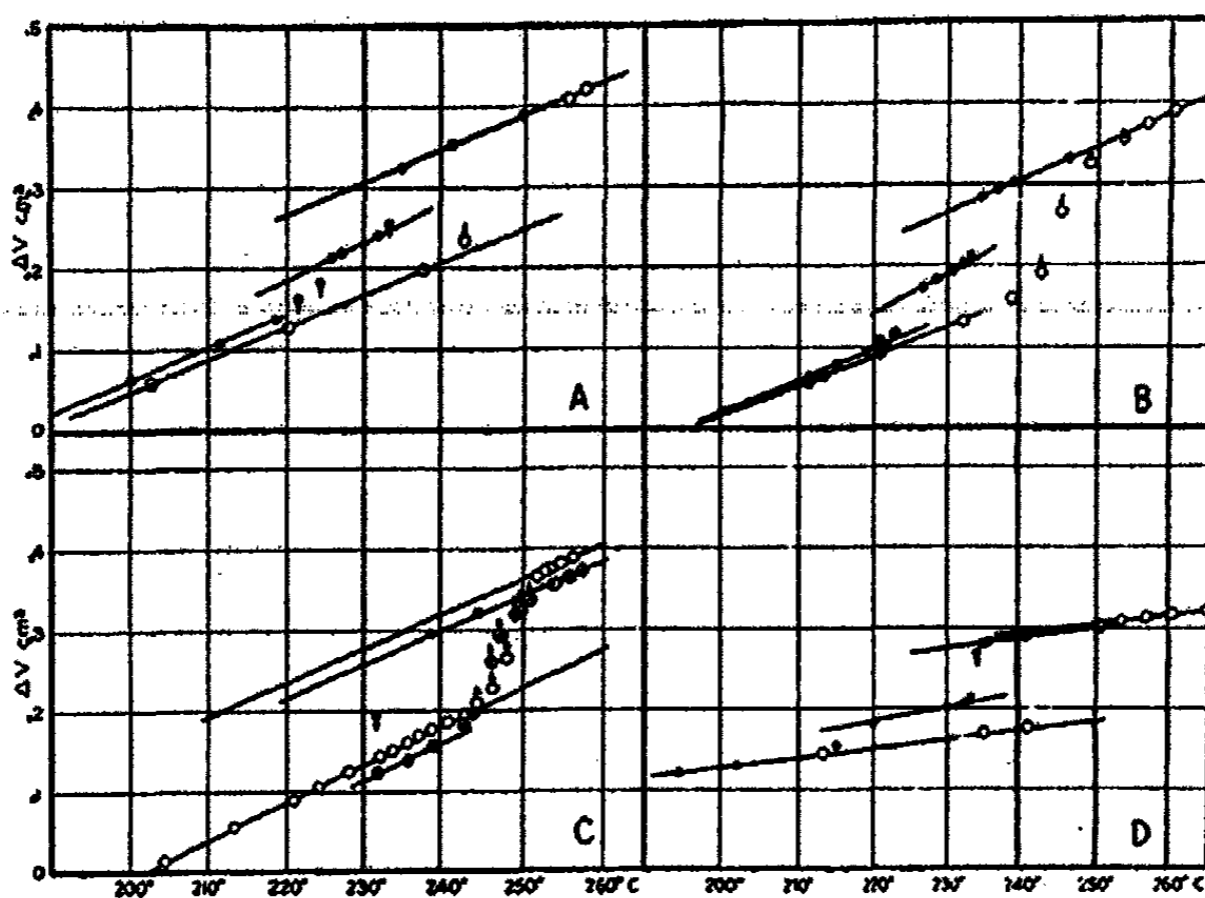

FIG. 8

Temperature-volume curves for dry  $\text{Na}_2\text{SO}_4$ . (Glass dilatometer.)

of the important IV $\rightarrow$ III change is  $185 \pm 1^\circ$ . This change is accompanied by a decrease in volume. An interesting property of this inversion is that its speed is apparently different in the two directions and that the rate of reaction method of determining the equilibrium temperature is not applicable.

In the left-hand curve of Fig. 12 details of a reversal experiment are given. As before, the arrows are drawn between consecutive observations and the directions of the tails on the circles indicate the direction of the volume drift. At  $187.0^\circ$   $\text{Na}_2\text{SO}_4\text{IV}$  was changing to  $\text{Na}_2\text{SO}_4\text{III}$ ; at  $185^\circ$ , the volume was constant, and at  $183.5^\circ$ , with both phases present, a slight increase in volume showed that  $\text{Na}_2\text{SO}_4\text{III}$  was transforming to  $\text{Na}_2\text{SO}_4\text{IV}$ . Even in presence of water, however, the III $\rightarrow$ IV transition showed great reluctance to proceed if there were no  $\text{Na}_2\text{SO}_4\text{IV}$  in contact with the  $\text{Na}_2\text{SO}_4\text{III}$ .

Turning to the upper inversion we see, by comparing curve B of Fig. 12 which is a cooling curve, with the heating curve in Fig. 11, that the hysteresis loop is very small; on heating the change is finished at  $246^\circ$  and on cooling it is already proceeding rapidly at  $240^\circ$ . Indeed it was easily possible to observe

this change taking place in one direction at  $243^{\circ}$  and in the opposite direction at  $240^{\circ}$ . We estimated the equilibrium temperature as  $241 \pm 1^{\circ}$ . The cooling curve also lacks the double break at  $236^{\circ}$  and  $220-230^{\circ}$  which is characteristic of the behavior of the dry sodium sulfate and, except for minor irregularities, no change appears to take place until below  $180^{\circ}$  when  $\text{Na}_2\text{SO}_4\text{IV}$  and then  $\text{Na}_2\text{SO}_4\text{V}$  are slowly re-formed.

On the day following the experiment which gave curve *B* in Fig. 12, the temperature having fallen overnight to  $100^{\circ}$ , observations were made on

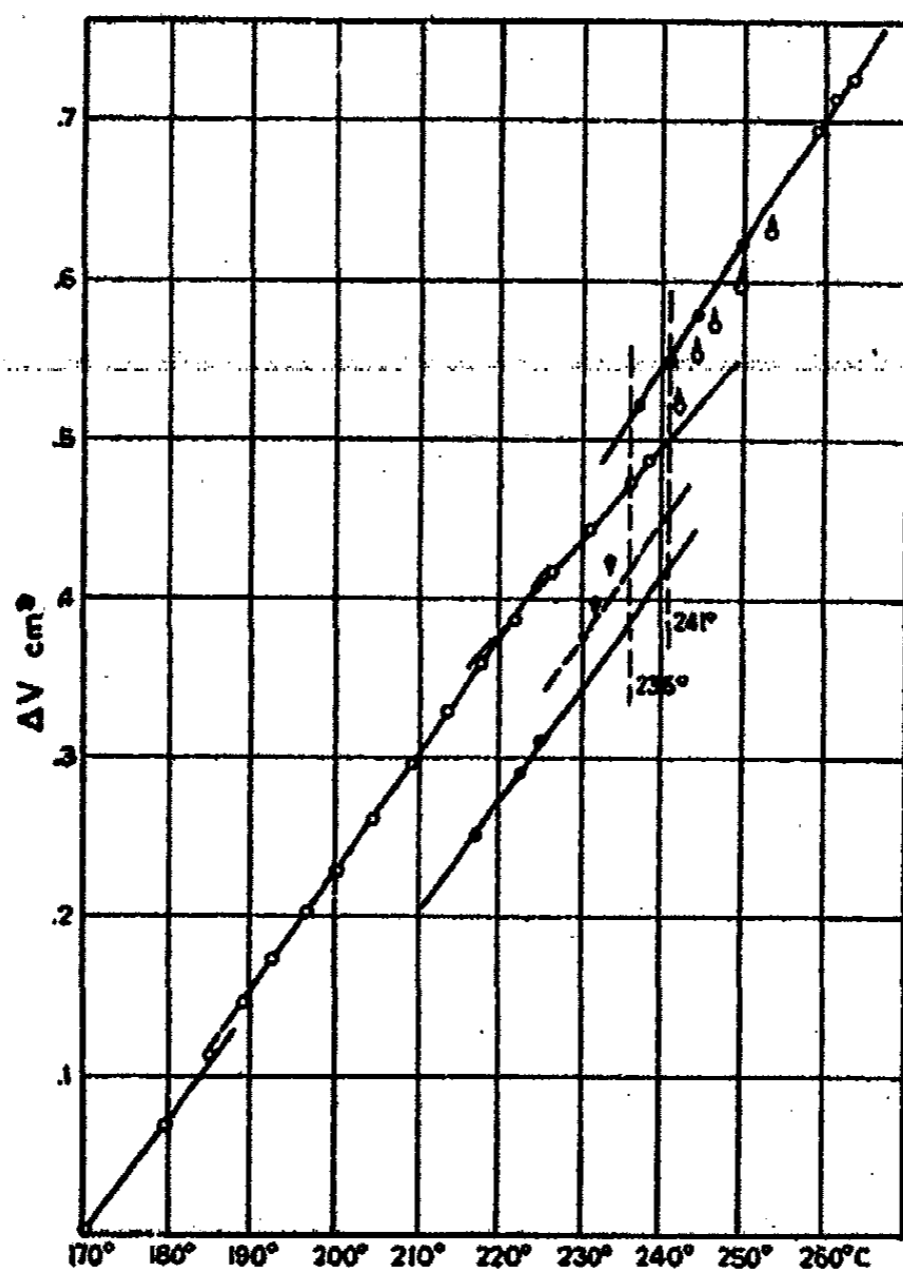

FIG. 9

Temperature-volume curve (heating and cooling) for dry  $\text{Na}_2\text{SO}_4$  in pressure dilatometer. Original phase  $\text{Na}_2\text{SO}_4\text{V}$ .

reheating the same material and these are recorded in curve *C* of the same figure. The appearance of both breaks characteristic of the lower inversions shows that during the night the sodium sulfate had all transformed to the nardite, which evidently is the stable form at lower temperatures.

The volume changes measured in these experiments with the moist salt are to be found under the appropriate headings in Tables I and III.

*Temperature-volume curves for slightly acid  $\text{Na}_2\text{SO}_4$ .* The behavior of Preparation 11, which it must be emphasized was free from superficial moisture, in the pressure dilatometer is recorded in Fig. 13. The heating and

cooling curves over the whole range are similar to those for  $\text{Na}_2\text{SO}_4$  in contact with solution. The lower inversions, the minor effects around  $220^\circ$ , the rapidity and small hysteresis loop of the upper inversion are all noteworthy features of resemblance, while the absence of the breaks on the cooling curve at  $235^\circ$  and  $225^\circ$  carry the similarity still further.

Curve A in Fig. 13 shows the results of a cycle of observations. After the lower inversions had been brought about heating was continued up to  $206^\circ$  and then the apparatus was cooled. Instead of following the broken

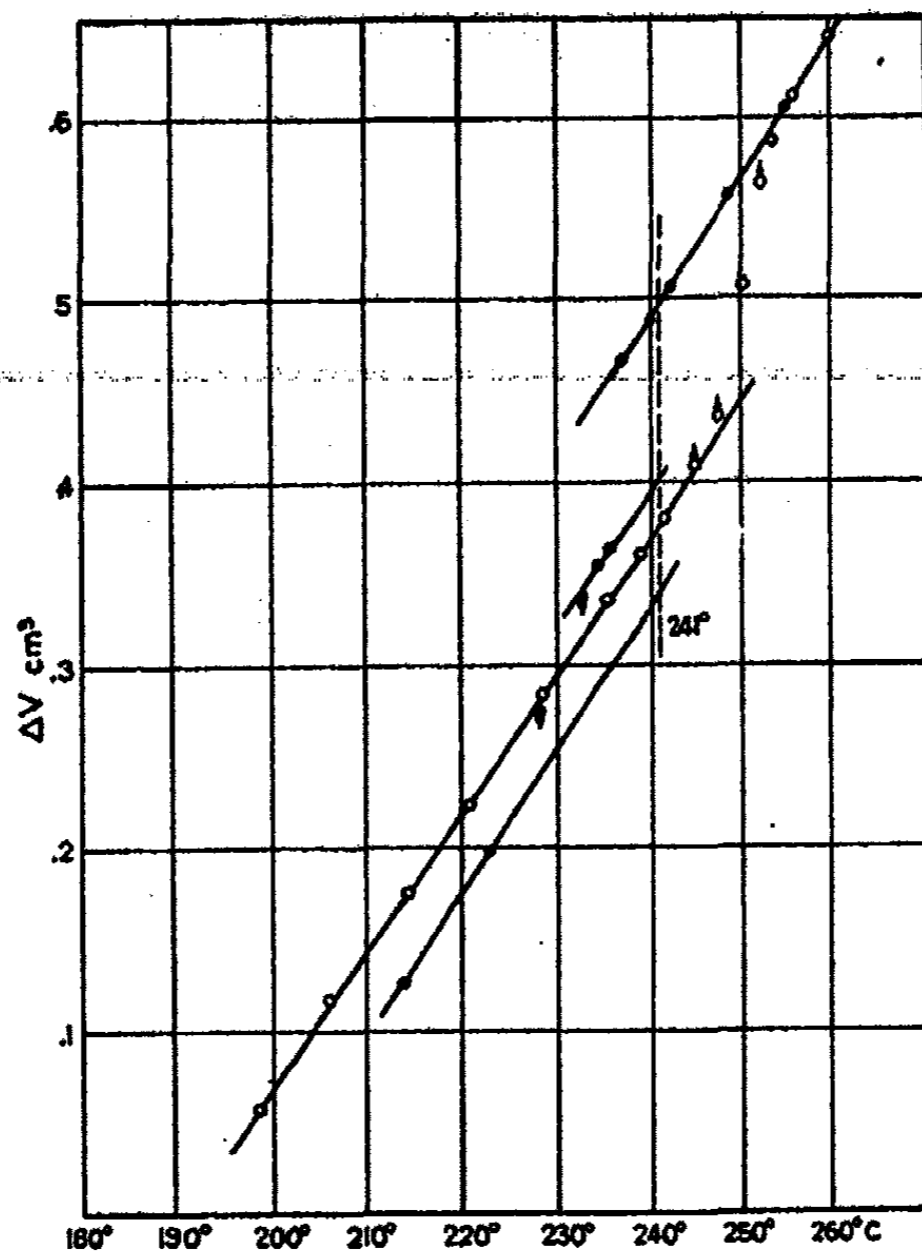

FIG. 10

Temperature-volume curve for dry  $\text{Na}_2\text{SO}_4$  in pressure dilatometer. Repetition experiment after Fig. 9. Original phase  $\text{Na}_2\text{SO}_4$ , III.

line the points on the smooth cooling curve fell somewhat higher. At  $176^\circ$  the point lay considerably above the extension of the upper branch of the heating curve. After several hours the volume changed to a value almost equal to that required by the broken line and shortly thereafter the III→IV inversion started. When this change was complete the observations again fell on the initial heating curve for thenardite, as may be seen from the two points marked with the double circles. This experiment and others convinced us of the reversibility of the  $185^\circ$  change and that leaks in the apparatus were quite inappreciable.

### Discussion of Results

*Influence of water on the polymorphic transformations.* A comparison of the results for the dry salt on the one hand and for the moist and slightly acid salts on the other shows conclusively that the presence of water not only accelerates the stable transformations but also materially reduces the hysteresis. Figs. 9 and 11 show how true this is for the IV→III change which is almost completely lost in the dry salt, and Figs. 9 and 13 show that the hysteresis in the upper inversion is reduced by water and the reaction

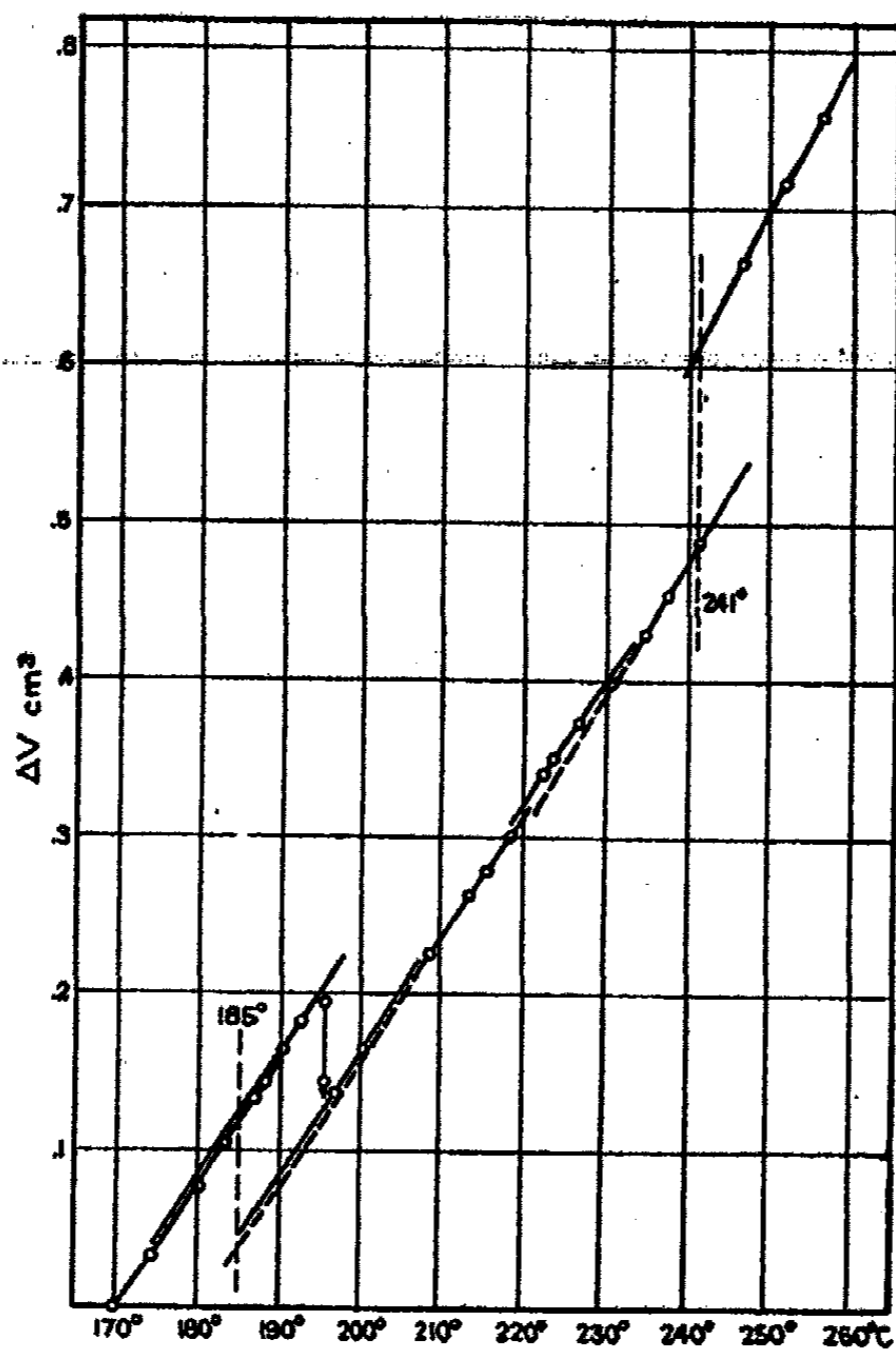

FIG. 11

Temperature-volume curve for  $\text{Na}_2\text{SO}_4$  in contact with saturated aqueous solution. (Pressure dilatometer.)

velocity increased. Indeed, the time required for the III→I change was reduced from more than an hour to about ten minutes by the presence of water. Such an effect may be due to rapid solution and recrystallization but we doubt if this is the whole story. It seems reasonable to conclude that recrystallization may provide a plentiful supply of nuclei of the new form and that from these nuclei the inversion sweeps through each solid crystal. Even in the case of the dry salt we have shown (Fig. 7) how much

more easily reversible the transformations may be when two phases are present.

*Stability of the phases.* Enough has been said to show that thenardite is the stable phase at room temperature, that thenardite passes reversibly to  $\text{Na}_2\text{SO}_4\text{IV}$  which in turn undergoes an enantiotropic change to  $\text{Na}_2\text{SO}_4\text{III}$  at  $185 \pm 1^\circ$ . The pressure dilatometer experiments make it impossible to avoid the conclusion that  $\text{Na}_2\text{SO}_4\text{III}$  is in equilibrium with  $\text{Na}_2\text{SO}_4\text{I}$  at  $241^\circ$  and that  $\text{Na}_2\text{SO}_4\text{II}$  therefore has no region of stability at low pressures.

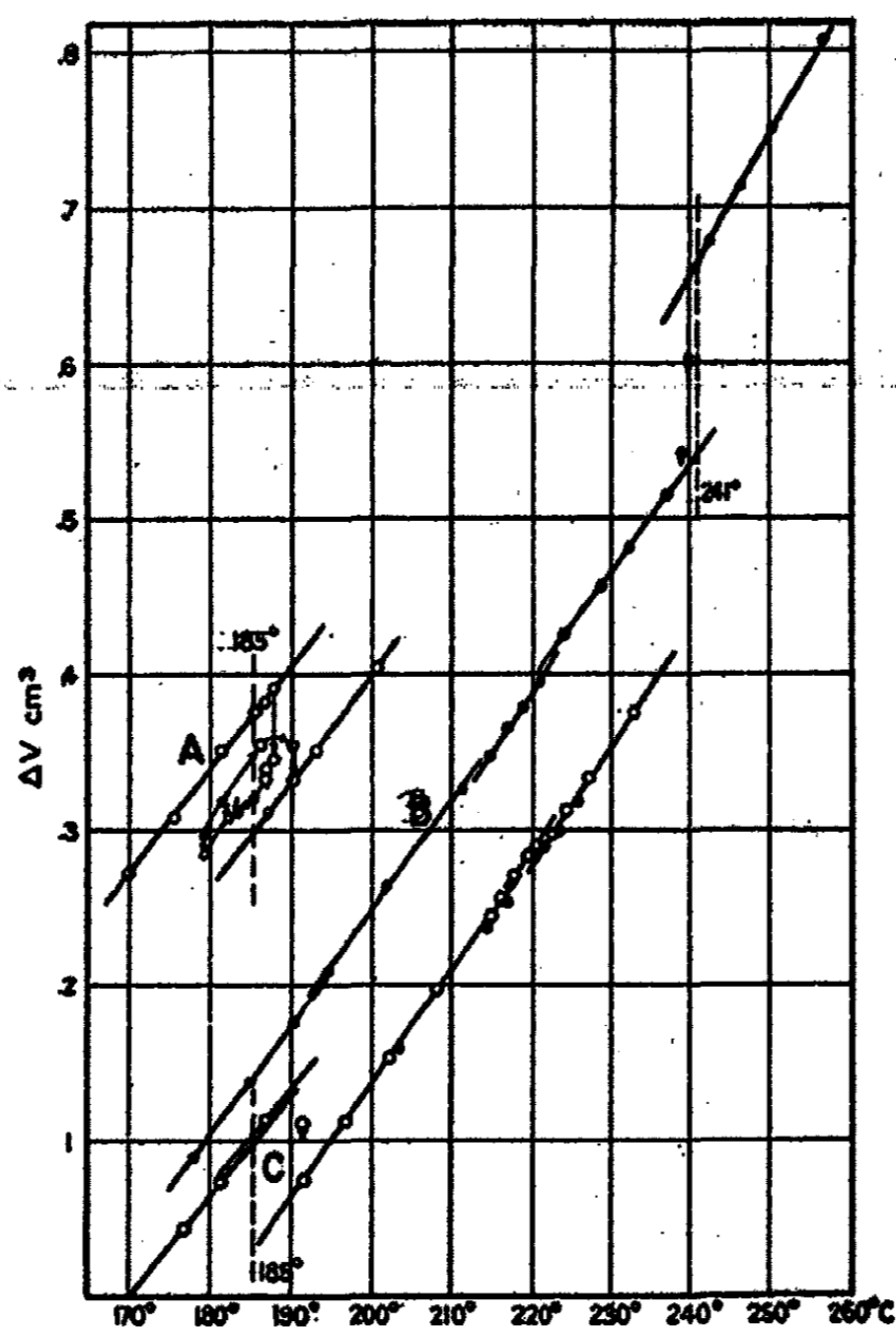

FIG. 12

Temperature-volume curves (heating and cooling) for  $\text{Na}_2\text{SO}_4$  in contact with saturated aqueous solution. Illustrative of the reversibility of the  $\text{IV} \rightleftharpoons \text{III}$  inversion.

The experiments with dry  $\text{Na}_2\text{SO}_4$  in the glass dilatometer showed that at  $236^\circ$  the transition  $\text{Na}_2\text{SO}_4\text{I} \rightleftharpoons \text{Na}_2\text{SO}_4\text{II}$  proceeded sharply and reversibly, that it was impossible to bring about the transformation  $\text{Na}_2\text{SO}_4\text{III} \rightarrow \text{Na}_2\text{SO}_4\text{II}$  even when both phases were in contact, and that no definite temperature could be assigned to the slow reaction  $\text{Na}_2\text{SO}_4\text{II} \rightarrow \text{Na}_2\text{SO}_4\text{III}$ . We have the following explanation to offer.  $\text{Na}_2\text{SO}_4\text{I}$  shows great reluctance to pass to  $\text{Na}_2\text{SO}_4\text{III}$  in the dry state and so when it is cooled the temperature

falls below the equilibrium temperature to that of the reaction  $\text{Na}_2\text{SO}_4\text{I} \rightleftharpoons \text{Na}_2\text{SO}_4\text{II}$ , a change which we have shown to take place promptly and rapidly at  $236^\circ$ , and so instead of the stable phase III we have the temporary appearance of the metastable phase  $\text{Na}_2\text{SO}_4\text{II}$ . When the temperature falls far enough II passes slowly and irreversibly to III. We have seen that water cuts down the hysteresis accompanying all the changes. Hence in the moist  $\text{Na}_2\text{SO}_4$  the reversible  $\text{I} \rightleftharpoons \text{III}$  change occurs promptly at  $241^\circ$  and  $\text{Na}_2\text{SO}_4\text{II}$  has no chance to appear. In view of these phenomena we must modify

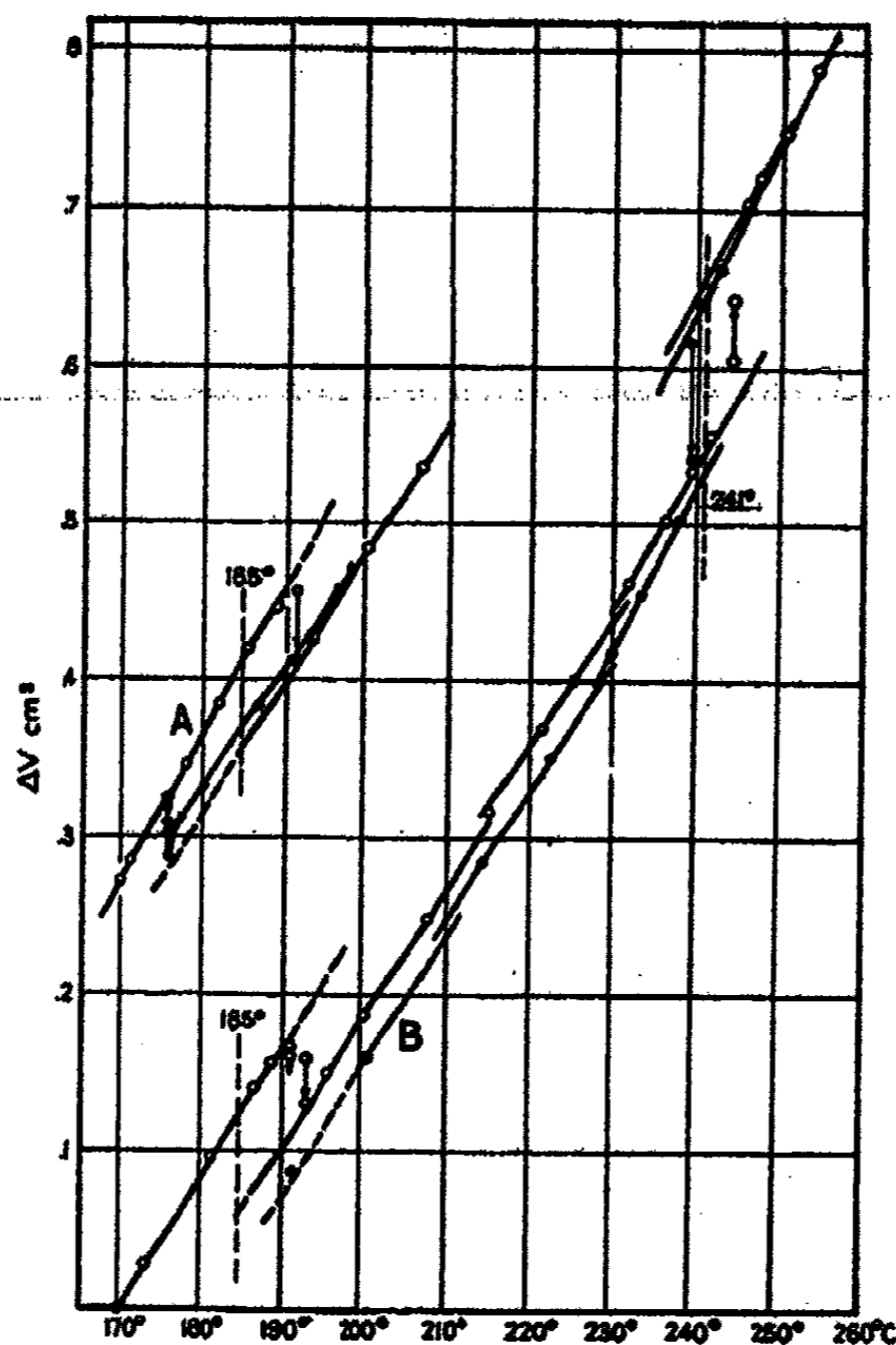

FIG. 13  
Temperature-volume curves for  $\text{Na}_2\text{SO}_4$  containing 0.4 per cent  $\text{H}_2\text{SO}_4$ . (Pressure dilatometer.)

Kracek's equilibrium diagram by displacing the hypothetical thermo dynamic potential-temperature curve for  $\text{Na}_2\text{SO}_4\text{II}$  parallel to itself so that below  $240^\circ$  it always lies above the curve for  $\text{Na}_2\text{SO}_4\text{III}$ . The modified diagram drawn so as to place the intersections representing the phase changes  $\text{IV} \rightleftharpoons \text{III}$ ,  $\text{III} \rightleftharpoons \text{I}$  and  $\text{II} \rightleftharpoons \text{I}$  at the appropriate temperatures is given in Fig. 14.

*Volume changes.* The inversion of  $\text{Na}_2\text{SO}_4\text{V}$  to  $\text{Na}_2\text{SO}_4\text{IV}$  was not very rapid and the change in volume involved was very small. We were unable to obtain any definite information about this reaction except that the volume

change is positive,  $\text{Na}_2\text{SO}_4\text{IV}$  has a higher specific volume than  $\text{Na}_2\text{SO}_4\text{V}$ , and that its magnitude is certainly less than  $0.0005 \text{ cm}^3$  per gram.

The transition  $\text{Na}_2\text{SO}_4\text{IV} \rightarrow \text{Na}_2\text{SO}_4\text{III}$  was much more amenable to investigation and after we had established the equilibrium temperature close to  $185^\circ$ , the change in volume accompanying the transition was determined by measuring the distance between the two portions of the heating curve at  $185^\circ$ . As already emphasized, it was not possible to study the inversion at  $185^\circ$  in the dry material; all these results refer either to the moist salt or to

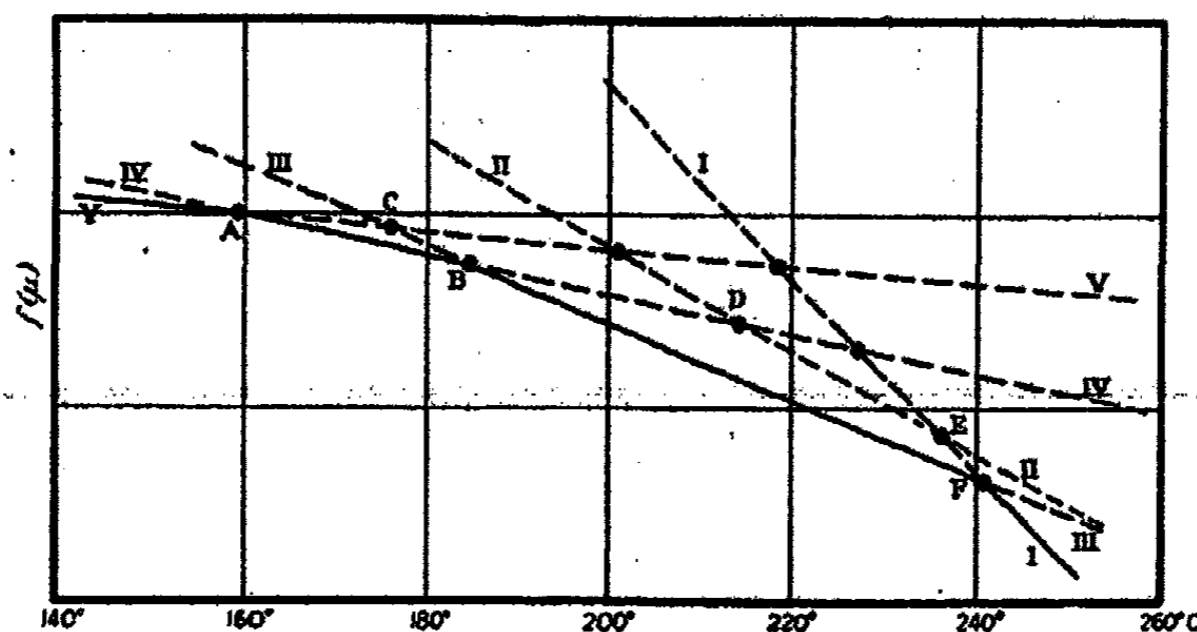

FIG. 14  
Modified equilibrium diagram illustrating the polymorphism of  $\text{Na}_2\text{SO}_4$ .

the acid salt. The results are to be found in Table I and are, on the whole, consistent. We may summarize them by saying that the volume change accompanying the reaction  $\text{Na}_2\text{SO}_4\text{IV} \rightarrow \text{Na}_2\text{SO}_4\text{III}$  is negative and amounts to  $0.0034 \text{ cc}$  per gram.

TABLE I  
Changes in volume accompanying the transition  $\text{Na}_2\text{SO}_4\text{IV} \rightarrow \text{Na}_2\text{SO}_4\text{III}$   
in the pressure dilatometer

Preparation	Figure in text	Weight in grams	Volume change in $\text{mm}^3$ at $185^\circ$	Volume change in $\text{cm}^3$ per gram at $185^\circ$
II	—	18.30	-66.5	-0.00363
II	13 B	18.30	-64.4	-0.00351
II	13 A	18.30	-61.0	-0.00333
2 + $\text{H}_2\text{O}$	II	21.7**	-75.7	-0.00349
2 + $\text{H}_2\text{O}$	12 C	21.7**	-77.4	-0.00356
2 + $\text{H}_2\text{O}$	12	21.7**	-76.3	-0.00352***
2 + dil. $\text{H}_2\text{SO}_4$	—	19.05**	-55.6	-0.00289
2 + dil. $\text{H}_2\text{SO}_4$	—	19.05**	-67.0	-0.00352
2 + dil. $\text{H}_2\text{SO}_4$	—	19.05**	-51.2	-0.00269***
Average				-0.00343

\*\* Refers to amount of salt in contact with saturated solution at  $185^\circ$ .  
\*\*\* Reversibility experiment.

In the second paper of this series<sup>1</sup> we showed that at 25° the specific volume of Na<sub>2</sub>SO<sub>4</sub>III is 0.0045 cc less than that of thenardite. Making allowances for the differences in thermal expansion we conclude that the agreement is close enough to warrant confidence in the estimate made with the pressure dilatometer.

It was possible to obtain estimates of the change in volume during the III→I transition both on heating and on cooling, in the glass dilatometer and in the pressure dilatometer. The results obtained with the former were quite consistent, as Table II shows, but those obtained with the pressure dilatometer (Table III) were not so precise and their agreement with the results in Table II leaves something to be desired.

TABLE II  
Changes in volume accompanying the transition Na<sub>2</sub>SO<sub>4</sub>III→Na<sub>2</sub>SO<sub>4</sub>I  
in the glass dilatometer

Preparation	Figure in text	Weight in grams	Volume change in mm <sup>3</sup> at 241°	Volume change in cm <sup>3</sup> per gram at 241°
2	6	22.97	161.0	0.00701
2	7	22.97	160.0	.00697
2	5	22.97	176.5	.00768
12	—	17.42	125.5*	.00720
12	8 D	17.42	120.0	.00689
10	8 B	20.55	148.9	.00725
10	8 A	20.55	142.5	.00693
10	8 C	20.55	141.5	.00689
10	8 C	20.55	143.5	.00698
			Average	0.00709

\* Measure of I→III.

Bearing in mind that the object of the pressure apparatus was to investigate questions of stability rather than to make accurate volumetric measurements, we shall give more weight to Table II and conclude that during the reaction Na<sub>2</sub>SO<sub>4</sub>III→Na<sub>2</sub>SO<sub>4</sub>I the change in volume is positive and equal to 0.0070 cc per gram.

We estimated the change in volume when Na<sub>2</sub>SO<sub>4</sub>I passes to Na<sub>2</sub>SO<sub>4</sub>II by measuring the distance between the two parts of the cooling curve at 236°. Owing to uncertainty of the end product which is metastable we can not claim that these figures are more than rough estimates. They are given in Table IV, and indicate that at 236° the specific volume of Na<sub>2</sub>SO<sub>4</sub>I is approximately 0.004 cc greater than that of Na<sub>2</sub>SO<sub>4</sub>II.

<sup>1</sup> Kracek and Gibson: J. Phys. Chem., 33, 1304 (1929).



TABLE III  
Changes in volume accompanying the transition  $\text{Na}_2\text{SO}_4\text{III} \rightleftharpoons \text{Na}_2\text{SO}_4\text{I}$  in the pressure dilatometer

Preparation	Figure in text	Weight in grams	Volume change in $\text{cm}^3$ per gram at $241^\circ$	Remarks
2	—	20.1	0.00651	Cooling
2	9	19.93	.00667	Cooling
2	10	19.93	.00610	Heating, repeat
2	10	19.93	.00788	Cooling, repeat
2	—	19.93	.00580	Heating, repeat
2	—	19.93	.00767	Cooling, repeat
10	—	16.8	0.00691	Heating
	—	16.8	.00723	Cooling
11	—	18.30	0.00598	Mean, heating and cooling
11	13	18.30	.00586	Mean, heating and cooling
2 + $\text{H}_2\text{O}$	11	21.7**	0.00587	Heating
2 + $\text{H}_2\text{O}$	12	21.7	.00571	Cooling
2 + dil. $\text{H}_2\text{SO}_4$	—	18.9**	0.0065	Mean, heating and cooling
2 + dil. $\text{H}_2\text{SO}_4$	—	18.9	.0064	Cooling

\*\* See Table I.

TABLE IV  
Changes in volume accompanying the transition  $\text{Na}_2\text{SO}_4\text{I} \rightleftharpoons \text{Na}_2\text{SO}_4\text{II}$ .

Preparation	Figure in text	Weight in grams	Volume change in $\text{cm}^3$ per gram at $236^\circ$	Remarks
2	5	22.97	0.0037	Glass dilatometer
2	7	22.97	.0038	"
12	—	17.42	0.0042	"
12	8	17.42	.0042	"
10	8	20.55	0.0035	"
10	8	20.55	.0035	"
2	10	19.93	0.0048	Pressure dilatometer
2	—	19.93	.0047	"
10	—	16.8	0.0039	"

#### Concluding Remarks

The results of this investigation are in good accord with the facts recorded in the first two papers of this series. The previous conclusion that  $\text{Na}_2\text{SO}_4$  is pentamorphic is confirmed in detail with the exception that we must now conclude that  $\text{Na}_2\text{SO}_4\text{II}$  has no region of stable existence at low pressures.

The metastable appearance of  $\text{Na}_2\text{SO}_4\text{II}$  in the very dry salt is not surprising when we consider that the temperature of the reversible metastable transition  $\text{Na}_2\text{SO}_4\text{II} \rightleftharpoons \text{Na}_2\text{SO}_4\text{I}$ , viz.  $236^\circ$ , lies within the hysteresis loop of the stable  $\text{Na}_2\text{SO}_4\text{III} \rightleftharpoons \text{Na}_2\text{SO}_4\text{I}$  inversion. The thermal analysis and the experiments in the glass dilatometer fix the extreme limits of this hysteresis loop as approximately  $220^\circ$  and  $250^\circ$ .

Establishing  $185^\circ$  as the equilibrium temperature of the IV $\rightarrow$ III change helps to clear up a previously noted but unexplained difficulty. In the thermal analysis no breaks were detected below  $195^\circ$ , yet, as observed in the first paper of this series,<sup>1</sup>  $\text{Na}_2\text{SO}_4\text{III}$  could be detected by microscopic examination in preparations which had been heated for some time at constant temperatures as low as  $190^\circ$ . It is now evident that  $\text{Na}_2\text{SO}_4\text{III}$  may appear over the region from  $185^\circ$  to  $241^\circ$ , in amounts which vary with the character and previous thermal treatment of the preparation. It was also pointed out in the first paper that as a consequence of the hysteresis the actual equilibrium temperatures could not be deduced from the thermal analysis curves. A comparison of the curves for the pressure dilatometer experiments on the dry and the moist salt (see Figs. 9 and 11) lends support to this statement, and Fig. 9 especially explains the occurrence of the lower inversions at temperatures considerably above the equilibrium points.

#### Summary

With the help of an ordinary dilatometer and a dilatometer specially developed for studying volume changes under a pressure of fifty megabaryes we have been able to confirm and amplify the results of the first two papers on the polymorphic transformations of  $\text{Na}_2\text{SO}_4$  between  $180^\circ$  and  $260^\circ$ . These changes take place slowly and are accompanied by marked hysteresis when the salt is dry, but in the presence of water or a trace of  $\text{H}_2\text{SO}_4$  the salt inverts promptly and rapidly. In consequence of the more accurate estimates of the transition temperature which we were thus able to make, we can assign to each modification the ranges of stability indicated by the following scheme where the figures below the arrows indicate the temperatures of each change and the figures above are the volume changes in  $\text{cm}^3$  per gram.

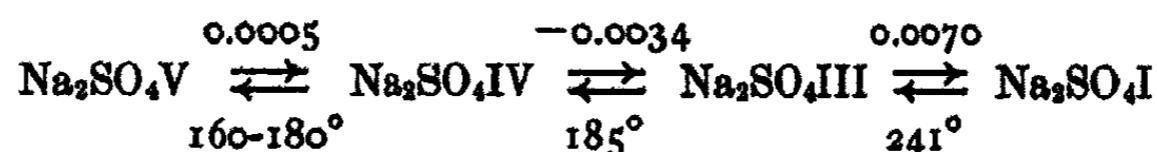

$\text{Na}_2\text{SO}_4\text{II}$  has no region of stability at low pressures, but if the reaction  $\text{Na}_2\text{SO}_4\text{I} \rightarrow \text{Na}_2\text{SO}_4\text{III}$  is inhibited, the transformation of  $\text{Na}_2\text{SO}_4\text{I}$  to  $\text{Na}_2\text{SO}_4\text{II}$  takes place reversibly at  $236^\circ$ , with a volume decrease of  $0.004 \text{ cm}^3/\text{g}$ .

*Geophysical Laboratory,  
Carnegie Institution of Washington,  
June, 1929.*

<sup>1</sup> Op. cit.

## A RULE FOR THE MECHANISM OF REACTIONS

BY PRESTON ROBINSON

The second law of thermodynamics tells us what reactions in a system are possible. But as to the mechanism by which these reactions may take place, thermodynamics tells us nothing. The statement of the second law for isothermal systems, that reactions proceed leading to the formation of the most stable substances, has, however, led to the implication that there was some connection between stability and mechanism. Thus arose the confusion between free energy and rate of reaction whereby the reaction with the greatest decrease in free energy was supposed to go the fastest.

So far is this from the truth that Ostwald was led to an opposite conclusion, that the reaction with the least decrease in free energy went the fastest. It has been shown however that Ostwald's rule holds in any system, only under half the possible conditions. So that there is no entirely satisfactory relation between stability and mechanism.

So another criterion for the mechanism of a reaction must be sought. In the rule here proposed, that criterion is the entropy of the substances formed. Entropy, besides being a measurable thermodynamic variable, connotes probability according to Boltzmann. Boltzmann's theorem has never been proven except for the isolated gaseous system, and the extension of it to the isothermal, heterogeneous system is the assumption on which the a priori demonstration of our rule is based. The rule is; in an isothermal system where several reactions are possible, that reaction takes place first whose products are of highest entropy.

If in such a system Boltzmann's theorem holds, the rule reads; in an isothermal system where several reactions are possible, that reaction takes place first whose products are most probable. The truth of such a rule is self-evident. But since there may be doubt as to the validity of Boltzmann's rule in such a system, we may examine the empirical justification of our rule.

To do this, it would be best simultaneously to compare this rule with other rules for mechanism. For this purpose, Ostwald's rule may be stated; in an isothermal system where several reactions are possible, that reaction takes place first whose products are least stable. To illustrate the working of these rules, consider the sulphur system in the neighborhood of the transition point in the reaction monoclinic sulphur  $\rightarrow$  rhombic sulphur. Above the transition point, monoclinic is stable and below it, rhombic is stable, while throughout this range in temperature, monoclinic is of higher entropy than rhombic. Gaseous sulphur (we shall neglect the possibilities of other forms of sulphur occurring) is of higher entropy than either form, and is unstable with respect to both when at above their vapor pressures.

Suppose now, gaseous sulphur is introduced under some pressure into an evacuated vessel held at a temperature below the transition point. Under

these conditions, gaseous sulphur is the substance of least stability and highest entropy. According to both rules it should remain as such, which it does, until something happens to disturb it. In such event, such as collision with the walls of the vessel, monoclinic sulphur appears. This is the substance of next lowest stability and next highest entropy. So far, then, we are in accord with both rules.

When we repeat the experiment, this time above the transition temperature, we observe identical behaviour, first the gaseous and then the monoclinic sulphur appear. From our rule, this was to have been expected, the substances appearing in order of decreasing entropies as before. But according to Ostwald's rule, rhombic sulphur should have made its appearance before monoclinic, because it is less stable. Actually, rhombic sulphur does not appear under these conditions; furthermore, rhombic sulphur never does appear in any system without first going through the monoclinic form. Thus Ostwald's rule holds on one side of the transition and not on the other. Similar behaviour may be shown to exist in any system. Whereas our rule, as shown, holds on both sides of the transition.

Tammann,<sup>1</sup> examining eight cases at random, all above the transition points, found that in five cases Ostwald's rule was obeyed, and in three it was not. He further indicated that the appearance of the new phase in each case was governed by probability considerations.

Tantzov observed the failure of Ostwald's rule in the sulphur system as reported above and in several other systems as well. He observed that in the reactions which took place as described above, there was as little possible change in entropy (temperature coefficient of free energy). This observation he generalised into a rule: where several reactions are possible, that reaction takes place first which involves the minimum change in entropy.<sup>2</sup>

This rule holds in any system where, if any reaction takes place, there must be a decrease in entropy. Thus in the sulphur system above, where gaseous sulphur under pressure was introduced into an evacuated vessel, the only reactions which could take place, whether above or below the transition point, involved a decrease in entropy. And in both cases, Tantzov's rule, like ours, was obeyed. If, however, when a reaction takes place which necessitates an increase in entropy, Tantzov's rule fails. If rhombic sulphur is introduced into an evacuated vessel at below the transition temperature, it vaporises immediately. The substance of highest entropy is formed. But according to Tantzov's rule, monoclinic sulphur should have been formed first, since such a reaction would involve a minimum change in entropy. Actually, monoclinic sulphur never appears under these conditions. Similarly, we should expect from Tantzov's rule that it would be possible to superheat solids above their melting points, whereas the phenomenon never has been observed.

<sup>1</sup> Tammann: "Aggregatzustände," 238 (1923).

<sup>2</sup> Tantzov: J. Chem. Soc., 112II, 367.

Thus we see that in the simplified sulphur system, both Ostwald's and Tantzov's rules of mechanism fail under some conditions. Under no conditions, on the other hand does our rule fail. The sulphur system used is typical of all systems. However, we shall continue the discussion, limiting ourselves to consideration of our rule only.

Take then, the water system with steam, water and ice as the possible phases. Of these, ice has the lowest entropy, steam the highest, and water the intermediate over a very wide range in temperature. If steam is introduced into a vacuum at below the melting point of ice, at first nothing happens. Then on collision with the walls of the vessel or other suitable disturbance, water is formed, even though the temperature is below the freezing point of water. It rains at first. If now a new disturbance, or catalyst, is introduced, ice is formed from the supercooled water. Ice itself, or some substance or vibration invariably associated with ice, is a suitable catalyst for this reaction. So far we are still in entire accord with our rule.

The question then arises, what happens when steam is introduced into the presence of an excess of ice, below the melting point of ice, and in such a manner that the melting point is not exceeded? Steam is of course transformed into ice, but during the process, does it or does it not pass through the water form? Macroscopically, the reaction to form ice is so rapid that we cannot say whether water is formed or not. We do observe however that the ice is formed in an angular, geometric pattern. That is to say, the ice is not built up molecule by molecule, but unit cell by unit cell. In ice, the number of molecules in the unit cell is probably very large, say as a minimum it is sixteen. So that, roughly, sixteen molecules associated in some random arrangement must be brought together before they can be transformed into ice. And sixteen or so molecules associated in some random arrangement correspond to the liquid state, or at least have the same entropy as the liquid state. So that it appears that steam does go through the liquid state in going over to the solid state.

After all, this was to be expected. Steam condenses to water in the absence of ice. Steam therefore would continue to condense to water, even in the presence of ice, unless the steam were possessed of some mechanism informing it of the presence of ice. As far as the letter of our rule is concerned, it is a matter of indifference what happens, for our rule says that the substance of highest entropy is formed first, while here the substance of lowest entropy is already present. However, the spirit of the rule certainly indicates that water should exist as an intermediary stage. The same result would be expected also from both Ostwald's and Tantzov's rules.

If ice is introduced into a vacuum at below the triple point, it vaporises immediately forming steam until the vapor pressure of ice at the temperature is reached, as according to our rule. If the temperature is raised to slightly above the triple point, water is formed, but how? Is water formed from condensing steam or from melting ice? In a condensed system, with the vapor phase absent, ice melts to form water. And steam can condense to

form water. So that water may be formed at the triple point from both ice and steam. Which then takes place first? Or better, if ice is introduced into a vacuum at the triple point, which is formed first, steam or water? Again we examine the case microscopically, and find that when a solid vaporises or melts, a molecule escapes from a corner of a crystal. The solid does not disintegrate unit cell by unit cell. After the first molecule has escaped, the collapse of a unit cell may follow. And the first escaping molecule corresponds to the vapor state. Macroscopically, the observation is confirmed by the fact that vaporising or melting solids appear to have their corners rounded off, in marked contrast to the angular pattern of freshly formed crystals. So we may safely say that ice when introduced into a vacuum at the triple point forms vapor first. That then water is formed, either from the steam or water or both. And this phenomenon is in accordance with our rule. And it is also in accordance with Ostwald's rule, though not at all in accord with Tantzov's.

So our rule of mechanism is established by close study of typical systems. Beyond this, there is much empirical justification of our rule in many well known phenomena. Thus it explains the super-cooling of liquids and the absence of superheating of solids. It predicts the formation of nascent gases in reactions. It would predict the occurrence of the monomolecular reactions, in spite of their strongly endothermic nature, because of the large increase in entropy. It would deny that hydrogen would react to form helium, in spite of the strongly exothermic nature of the reaction, because of the tremendous decrease in entropy.

#### Summary

A rule for the mechanism of reactions is proposed; in an isothermal system, where several reactions are possible, that reaction takes place first whose products are of highest entropy.

The working of this rule in two typical systems is examined and found to be justified empirically.

*New York, N. Y.*

24 B 9  
6-18

NOTE ON THE DISSOCIATION CONSTANTS OF CERTAIN  
SULFONPHTHALEIN INDICATORS

BY MARY KILPATRICK AND MARTIN KILPATRICK, JR.

In the recent paper by Sendroy and Hastings<sup>1</sup> entitled "The Activity Coefficients of Certain Acid-Base Indicators" there appear a number of erroneous statements, which we shall briefly point out.

An indicator of the type of a monobasic acid has a stoichiometric or classical dissociation constant,  $K_o$ ,

$$K_o = \frac{c_{H+}c_{J^-}}{c_{HJ}}$$

$c_x$  representing the molar or molal concentration of the species in question, and a thermodynamic dissociation constant  $K_a$  (which is  $K$  in the symbols of Sendroy and Hastings)

$$K_a = \frac{c_{H+}c_{J^-}}{c_{HJ}} \cdot \frac{f_{H+}f_{J^-}}{f_{HJ}} = K_o \cdot \frac{f_{H+}f_{J^-}}{f_{HJ}}$$

where  $f_x$  represents the activity coefficient (in the appropriate concentration scale), and  $c_x f_x$  the activity, of any species. If the indicator passes through a number of tautomeric forms before ionization occurs, the dissociation constants are spoken of as "apparent" dissociation constants; the formal treatment, however, remains unchanged.<sup>2</sup>

The constants for the first dissociation of a dibasic acid are the same as those given above for a monobasic. For the second dissociation,

$$K_o = \frac{c_{H+}c_{J^{2-}}}{c_{HJ^{2-}}}$$

$$K_a = \frac{c_{H+}c_{J^{2-}}}{c_{HJ^{2-}}} \cdot \frac{f_{H+}f_{J^{2-}}}{f_{HJ^{2-}}} = K_o \cdot \frac{f_{H+}f_{J^{2-}}}{f_{HJ^{2-}}}$$

From the thermodynamic dissociation constant the Henderson-Hasselbalch equation

$$p_{a_{H^+}} = pK' + \log \frac{c_J}{c_{HJ}}$$

is directly derivable. In this equation,  $p$  denotes negative logarithm to the base 10,  $a_{H^+}$  is the activity of the hydrogen ion or  $c_{H^+} f_{H^+}$ ,  $c_J$  is the concentration of the indicator present in the basic form,  $c_{HJ}$  the concentration of indicator present in the acid form (the ratio  $c_J/c_{HJ}$  is (BA)/(HA) in the

<sup>1</sup> Sendroy and Hastings: J. Biol. Chem., 82, 197 (1929).

<sup>2</sup> Anyone unfamiliar with this term is referred to Clark: "The Determination of Hydrogen Ions," 3rd Edition, p. 113.

symbols of Sendroy and Hastings), and for an indicator of the type of a monobasic acid,

$$K' = K_a \cdot \frac{f_{HJ}}{f_{J^-}}$$

while for an indicator of the type of a dibasic acid, in its second dissociation,

$$K' = K_a \cdot \frac{f_{HJ^-}}{f_{J^{2-}}}$$

Sendroy and Hastings<sup>1</sup> state that "If the activity coefficient of the undissociated acid is assumed to be unity,

$$K' = K/\gamma_A"$$
 (which is  $K_a/f_{J^-}$  in our symbols)

"where  $K'$  denotes the apparent stoichiometric dissociation constant —." This statement is incorrect. Assuming  $f_{HJ}$  to be unity,  $K_a$ , the stoichiometric dissociation constant, becomes

$$\frac{K_a}{f_{H^+}f_{J^-}}$$

Another error appears on page 235 of the paper by Sendroy and Hastings. Guntelberg and Schiödt<sup>2</sup> have evaluated the ratio  $K_o/K_a$  in 0.1 M to 3.0 M potassium chloride solution, and in 3.0 to 5.0 M sodium chloride solution, for a number of indicators, among them the indicator bromphenol blue (tetra-bromophenolsulfonphthalein). In 0.1 M potassium chloride solution the value found by Guntelberg and Schiödt for  $K_o/K_a$  for bromphenol blue is 2.12. Sendroy and Hastings calculate "from their single result" (that of Guntelberg and Schiödt) "at low concentrations, where  $k_o/K_a$  corresponding to our  $K'/K$  is given as 2.12 ——" that " $pK' = pK - 0.33$ ." Now  $K_o/K_a$  does not correspond to  $K'/K$ . For a monobasic acid,

$$\frac{K_o}{K_a} = \frac{f_{HJ^-}}{f_{H^+}f_{J^-}} = \frac{K'}{K} \cdot \frac{1}{f_{H^+}}$$

and for the second dissociation of a dibasic acid

$$\frac{K_o}{K_a} = \frac{f_{HJ^-}}{f_{H^+}f_{J^{2-}}} = \frac{K'}{K} \cdot \frac{1}{f_{H^+}}$$

Therefore,

$$\begin{aligned} pK' &\neq pK - 0.33 \\ pK' &= pK - \log(f_{H^+})(2.12). \end{aligned}$$

Guntelberg and Schiödt calculate that  $f_{H^+}$ , the individual activity coefficient of the hydrogen ion in 0.1 M potassium chloride solutions, is 0.81. This is not based upon thermodynamic reasoning, but upon the assumption that  $f_{K^+}$  equals  $f_{Cl^-}$  in potassium chloride solution. If we insert this value of  $f_{H^+}$

$$\begin{aligned} pK' &= pK - 0.236, \text{ or since } \Delta pK' = pK - pK' \\ \Delta pK' &= 0.236 \end{aligned}$$

<sup>1</sup> Sendroy and Hastings: J. Biol. Chem., 82, 200 (1929).

<sup>2</sup> Guntelberg and Schiödt: Z. physik. Chem., 135, 393 (1928).



This corrected value of  $\Delta pK'$  for bromphenol blue compares as nearly to the  $\Delta pK'$  given by Sendroy and Hastings for phenol red, as it does to their  $\Delta pK'$  for bromcresol purple, or bromcresol green. In buffer solutions containing potassium chloride, the ionic strength being 0.10, Sendroy and Hastings find

$$\Delta pK' \text{ for phenol red} = 0.21$$

$$\Delta pK' \text{ for bromcresol purple} = 0.29$$

$$\Delta pK' \text{ for bromcresol green} = 0.27.$$

From the value of  $\Delta pK'$  for bromphenol blue in 0.1 M potassium chloride solution Sendroy and Hastings are not justified in inferring that bromphenol blue is a "dibasic" indicator.

When stating that the salt error in indicator work "has been allowed to rest as a purely empirical matter" Sendroy and Hastings neglect the paper of Güntelberg and Schiödt. Having reiterated Brönsted's definition<sup>1</sup> of "salt error" Güntelberg and Schiödt present the problem of salt error in indicator work in clear and straightforward fashion.

*The Cancer Research Laboratory, and  
the Laboratory of Physical Chemistry  
of the University of Pennsylvania.  
May 23, 1929.*

<sup>1</sup> Brönsted: J. Chem. Soc., 119, 589 (1921).

## BINARY SYSTEMS OF CERTAIN NITROTOLUENES WITH SALICYLIC ACID\*

BY H. D. CROCKFORD AND F. W. ZURBURG

The purpose of this investigation was to determine the temperature-composition diagrams for the systems: 2-4-6-trinitrotoluene, 2-4-dinitrotoluene, and p-nitrotoluene, with salicylic acid. The work is a continuation

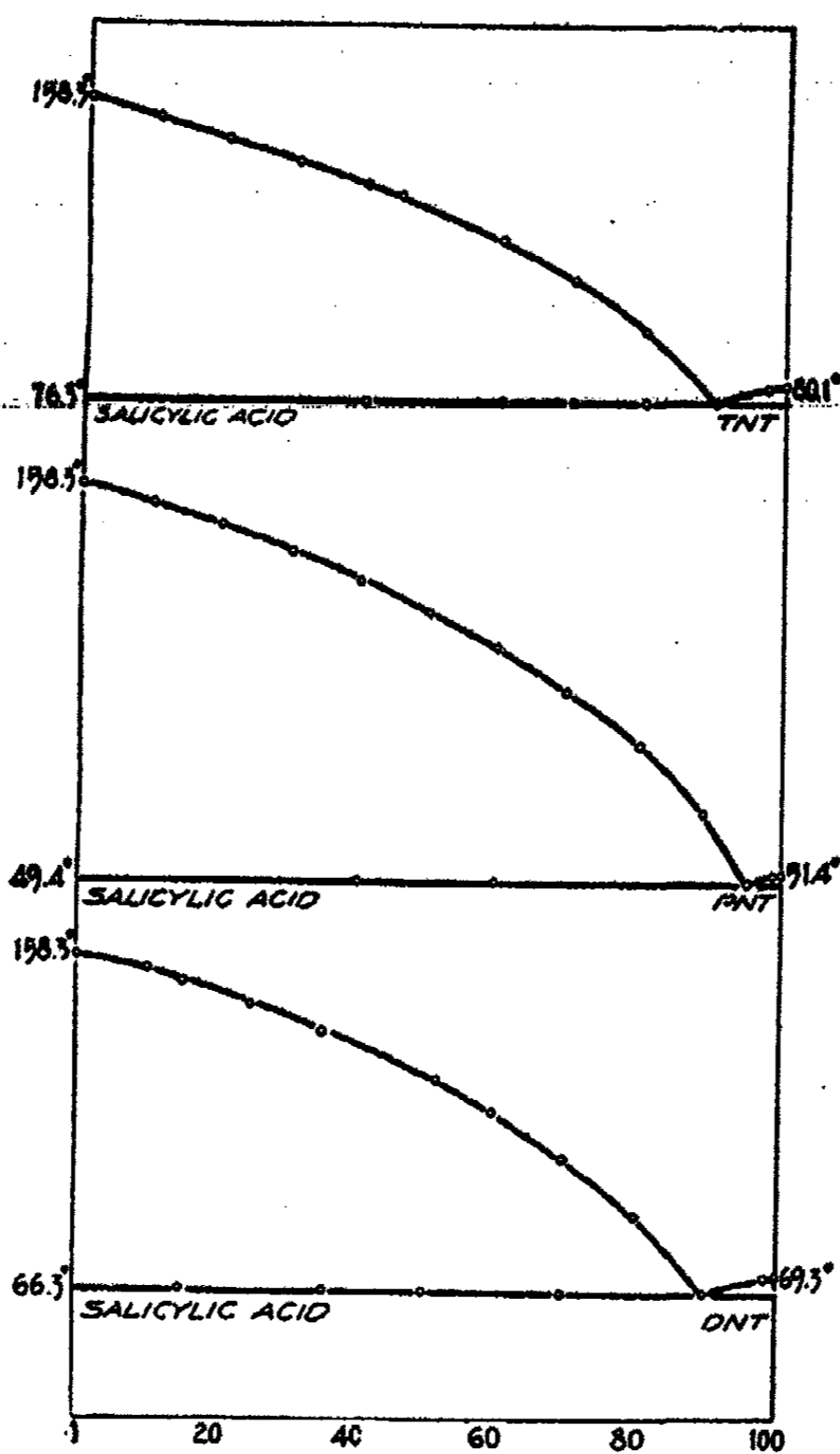

Fig. 1

of a series of investigations which have been carried on by James M. Bell<sup>1</sup> and his co-workers on the subject of the nitrotoluenes in the Department of Chemistry of the University of North Carolina.

\* From the Chemical Laboratory of the University of North Carolina.

<sup>1</sup> Bell and Sawyer: *J. Ind. Eng. Chem.*, 11, 1025; Bell and Cummings: 1028; Bell and Herty: 1124; 1128 (1919); Bell, Cordon, Spry and White: 13, 59; Bell and Cordon: 307; Bell and Spry: 308 (1921); Bell and McEwen: 14, 536 (1922).

**Purification of Material.** The salicylic acid was prepared by twice recrystallizing C.P. grade acid from water. A constant melting point of 158.3°C was secured. The nitrotoluenes were purified by two crystallizations from hot carbon tetrachloride followed by one crystallization from hot ethyl alcohol. The following melting points were obtained: 2-4-6-trinitrotoluene, 80.1°C; 2-4-dinitrotoluene, 69.3°C; p-nitrotoluene, 51.4°C.

**Experimental Procedure.** The cooling curves of various mixtures of about twenty grams total weight were obtained by placing the sample in a six-inch test tube, which was air-jacketed in a test tube of larger diameter, which in turn was placed in an Erlenmeyer flask containing Nujol, the system being then heated to a point above the fusion temperature of the mixture and allowed to cool at room temperature. Thermometer readings were made on the melt at half-minute intervals, the melt being constantly stirred with a glass-loop stirrer during the cooling process. The thermometers used were graduated in 1/10°C intervals and were standardized by comparison with thermometers certified by the Bureau of Standards. All temperature values have been corrected for stem exposure. In obtaining the freezing points from the cooling curves the method of interpretation proposed by Bell and Herty<sup>1</sup> was followed.

**Results.** Tables I, II, and III give the freezing points for the various mixtures. The temperature-composition diagrams are plotted in Fig. 1. Concentrations are expressed in mol percents.

TABLE I

% Salicylic Acid	% TNT	F.P.	% Salicylic Acid	% TNT	F.P.
100	0	158.3°	40.9	59.1	120.0
90	10	152.7	30	70	107.9
80	20	147.1	19.9	80.1	93.4
70	30	140.6	10	90	76.3
59.9	40.1	134.0	3	97	79.0
55.1	44.9	130.1	0	100	80.1

TABLE II

% Salicylic Acid	% PNT	FP	% Salicylic Acid	% PNT	FP
100	0	158.3°C	29.7	70.3	102.6
89.9	10.1	152.0	19.5	80.5	88.0
79.8	20.2	145.8	12.5	87.5	68.3
69.8	30.2	139.0	5.1	94.9	49.4
61.2	38.8	131.0	1.9	98.1	50.45
50.1	49.9	123.9	0	100	51.4
39.7	60.3	114.0			

<sup>1</sup> J. Ind. Eng. Chem., 11, 1124 (1919).

TABLE III

% Salicylic Acid	% DNT	FP	% Salicylic Acid	% DNT	FP
100	0	158.3°C	48.6	51.4	124.5
91.2	8.8	154.3	39.7	60.3	113.4
84.4	15.6	150.5	29.3	70.7	102.3
74.6	25.4	144.0	20.4	79.6	86.8
64.4	35.6	137.2	10.1	89.9	66.3
			2.0	98.0	68.4
			0	100.00	69.3

p  
BC  
D  
W  
BD  
B  
BL  
S  
B  
L

## NEW BOOKS

**An Introduction to Biophysics.** By David Burne. *Second edition.* 24 × 16 cm; pp. xix + 580. New York: The Macmillan Company, 1929. Price: \$7.00. In this second edition the scope of the book has been altered slightly to make it more in accord with the Syllabus of Biophysics suggested by the General Medical Council. "The text however, has not been cut merely to suit examinations, but an attempt has been made to view the human body as far as possible as a physical machine. To do this adequately a knowledge of mathematics beyond the stage usually professed by medical and other students of the Biological Sciences is necessary. We have therefore cut down mathematical treatment to the minimum and have indicated where the student who desires to study the subject further may get additional information."

In the introduction, p. xviii, Professor Noël Paton says: "It has been through the co-operation of physics and chemistry that the solution of many of the problems of life have been reached, and as the possibility of reaching these solutions has become more generally recognised, the spirit of scientific curiosity—the desire to know, which is the basis of all scientific work—has been stimulated; although probably in the future, as in the past, humanity will still be divided into the enormously large class of those who have no real desire to understand the workings of nature and the very small class of those who have the spirit of curiosity, who do desire to know. These alone are the scientists, although many science graduates belong to the major class.

"With or without any wider diffusion of the spirit of curiosity, the development of the critical faculty and the better training of the younger workers in physics and chemistry has brought physiology nearer to the position of an exact science, and with this, its value as a training for students of medicine has greatly increased. The doctor, in making a diagnosis, has not merely to observe and record what has happened, but he must ascertain why it has happened. His problems are the same in nature and his methods are the same as those of the physiologist, and this physiology has regained its position as the Institute of Medicine. . . .

"The book is intended for students of human physiology, although it cannot fail to interest all workers in biology. It demonstrates what a large number of the characteristic reactions of living matter may be explained in terms of ordinary physical processes, and it thus shows the reduction which is taking place in the number of phenomena which some are still content to explain as due to a mysterious vital action instead of simply confessing that they are not yet understood. As the application of physics and chemistry to physiology is extended, it is safe to predict that fewer and fewer of these vital manifestations will remain unexplained.

"The origin of living matter, its increase and dispersion all over the globe, its marvellous and endless developments and evolutions, and its reactions with its surroundings may all be explained in terms of physics and chemistry. But consciousness and its association with living things will ever remain the mystery it has been and is."

The book is divided into five sections: energetics; cellular mechanics; cell communities; transport; the animal as a whole. Under energetics the six chapters are entitled: laws of energy; the storage of energy; calorimetry; the animal as machine; energy of substances in solution; surface energy. Under cellular mechanics the seven headings are: ionisation; colloids; soap and emulsions; enzymes—the tools of the cells; membranes; the cell; radio-activity. Under cell communities there are eight chapters: the army wherewith the body wages war with nature—the muscle cells; manufacturing cells; the army for home defence; the civil engineers of the body; the intelligence service—nerve cells; general and intra-communal receptors; distance receptor for sound—the ear; distance receptor for light—the eye. The last three chapters are grouped together and the subdivision, outposts of the intelligence service.

Under transport we find inland transport with five chapters: the blood; the respiratory function of the blood; loading up; the circulation; the electro-cardiogram. There are three chapters dealing with overseas transport: external respiration; the voice; alimentary canal. The section closes with a chapter on the movements of the limbs.

In the section on the animal as a whole, the chapters are entitled: the preservation of neutrality; the regulation of temperature; tropisms—the slaves of the lamp; adaptation; development; death and dissolution; the efficiency of the organism.

"Hardy's proof that the oriented layer may be several molecules thick is both simple and unequivocal. He allowed the fluid under test to be drawn in by capillarity between, say, a microscope slide and a weighted cover-slip. The force exerted is sufficient to lift the cover-slip and its weight from their bed. Every molecule of fluid drawn in must, by the fact that it is drawn in, be under the influence of the glass surfaces. The fluid is now frozen, and the cover-slip broken away. The layer of solidified fluid left is quite visible and is capable of measurement in depth, in tensile strength and in resistance to shear. This experiment indicates that the thickness of the layer under the influence of surface forces is at least of the order of 1,000 molecules, its value depending on the eccentricity or the equipotential surfaces of the molecules. The greater the eccentricity of the fields of force about the molecules (*i.e.* the greater their polarity) the thicker will be the oriented layer," p. 47.

"In the group of alkali metals tabulated above it will be seen that the lightest metal, lithium, furnishes the most sluggish ion of the three, and conversely, the most mobile ion is that of the heaviest metal, potassium, sodium being intermediate both in atomic weight and in speed. This is supposed to mean that lithium is more heavily hydrated than sodium, and sodium more than potassium. The number of molecules of water combined with their chlorides when completely dissociated is respectively 21, 13 and 9. If the molecules of water which form an envelope for the chlor-ion be subtracted from the total, lithium is found to be hydrated to the extent of 16 and sodium to 8 molecules," p. 58.

"The amplitude of vibration of a particle is a function of its mass, temperature being kept constant. As the mass alters so will the period of vibration. According to Wood, metallic particles, if highly dispersed, owe their colour not to ordinary reflection, diffraction, interference, etc., but to optical resonance. Resonance is the production of vibrations in a body by the periodic application of a stimulus which has the same period as the natural period of the body. The vibrations of a tuning fork may be transmitted through the air and cause to vibrate another tuning fork of the same pitch. Since the resonator owes the energy necessary to set it into vibration to the stimulating body, it follows that the stimulating body must lose energy to the resonator. The particles in colloidal solution are supposed to be vibrating with the same frequency as light of a certain wave-length. Consequently, they will receive energy from the light which will tend to increase their amplitude of vibration. The kinetic energy of the solution will tend to increase, but any increase in kinetic energy would mean increase in temperature and a slight alteration in frequency. This opens up the possibility of considerable energy changes in comparatively short times," p. 78.

"The intimate connection between coagulation and the charge carried by the particles is shown by the action of the  $\beta$  rays of radium. As these rays are negative charges of electricity, they should stabilise negative colloids by increasing their charge, and precipitate positive colloids by neutralising their charge. Hardy found that positively-charged acid-globulin was reduced to a state of jelly in three minutes, while the particles of negatively charged alkaline-globulin were rendered more mobile by exposure to  $\beta$  radiation. Schanz found that ultra-violet light by its power of ionizing water could decrease the solubility of albumin so that it was precipitated along with the globulins. He attributed the production of sclerosis and lack of elasticity of the lens of the eye to light of short wave-length acting in this way on the mixture of albumin and globulin composing it," p. 96.

"At a very low concentration of disodium phosphate, the rate of diffusion of water from pure solvent into the solution increases rapidly with increasing concentration; it reaches a maximum at a comparatively low concentration of the salt, *viz.*: M/128. This

increase in rate has been shown to be due to the predominance of the attractive action of the anion upon the positively charged hydrols. With an increase in concentration beyond  $M/128$  the rate of diffusion falls abruptly to reach a minimum at a concentration of  $M/16$ . This fall is caused by the increasing prevalence of the repelling action of the cation on the positively charged particles of water. Further increase in concentration causes an increase of rate of diffusion. The final passage of water into the solution is due to true osmotic pressure. *At the concentration where the rate of diffusion is decreased, i. e. where the curve falls ( $M/256-M/16$  in the case of  $Na_2HPO_4$ ) water passes from the solution through the collodion membrane to the pure solvent. That is, negative osmosis takes place," p. 141.*

"The crystalloids, too, differ in their physical attributes from similar salts in solution. A salt solution isotonic with a 0.9 per cent, solution of sodium chloride exerts no osmotic effect either positive or negative on the mammalian cells, but has an electrical conductivity above five to thirty-five times as great as the cells. That is, the cell offers a greater resistance to the passage of an electrical current than its content of electrolytes would lead one to expect. If now, the cell is injured so that its contents undergo disintegration, its conductivity will approach that apparently justified by its composition. The high electrical resistance of living matter is due mainly to two factors—(1) the state in which the water is held, and (2) the adsorption of a large proportion of the electrolytes.

"The water and a large proportion of the salts are dispersed through an apparently homogeneous colloidal mass. From ultra-microscopic examination one learns that the protoplasm varies in viscosity from cell to cell and more markedly from animal to animal. Some cells are almost liquid, as demonstrated by the vigour of the Brownian movement of the smaller granules in them, while other cells appear to be decidedly viscous with sluggish granular movements. The *ameboid* egg exemplifies the former and the *sea urchin's* egg the latter state.

"The viscosity of protoplasm may be influenced by alterations in the immediate environment. An excess of salts of monovalent elements, *e.g.* Na, K, guanidine, leads to an increase in liquidity, while divalent cations produce the opposite effect. The presentation of a suitable mixture of mono- and divalent salts lead to the optimum viscosity of any particular cell, p. 149.

"As is well known, potassium is an absolutely necessary constituent of the fluid used for the perfusion of an organ. If a potassium-free Ringer's fluid is passed through a frog's heart, the heart will come to a standstill in about half an hour. The frog's peripheral vessels may be perfused with Ringer's fluid for hours without any signs of oedema. As soon as a potassium-free fluid is used, marked oedema begins, causing the frog to swell and increase in weight. Further, the frog's kidneys when perfused with Tyrode's fluid or similar fluid containing glucose allows no glucose to pass out into the urine. If the potassium is omitted in making up the fluid, glucose at once escapes into the urine. Ringer demonstrated long before its radio-active nature was discovered, that rubidium may be substituted for potassium in equimolecular amounts. He explained this by its similar chemical nature. Similarly, caesium, another of the lighter radio-active elements, may take the place of potassium in the perfusion fluid. No non-radio-active element has been found which is capable of acting as a substitute for potassium. Further, Zwaardemaker was able to perform normal perfusions provided a substance emitting  $\beta$  rays was within effective distance of the frog," p. 161.

"There is scarcely a tissue or fluid in the body that does not contain fat in amounts in excess of the quantities that can be dispersed in colloid-free water. Finely divided fat in cell protoplasm is comparable to an emulsion. It depends for its permanence on the same factors as maintain fat in a finely divided form in an aqueous dispersant, *i.e.* mainly on the presence, in the tissues, of hydrophilic colloids. While the fat *in the cells* is not ordinarily visible or even demonstrable by microchemical methods, when an excessive amount of fat is present it may be seen in the network of areolar fibrous tissue, especially round the smaller blood vessels. Little droplets of oil at first appear and these become larger, run together and coalesce, forming a single large globule, distending the cell and pushing to the sides the protoplasm as a sort of capsule. Reference to the chapter on emulsion will show when the

*colloid* in an oil-in-colloid emulsion decreases in hydrophilic power beyond a certain amount, the nature of the emulsion is changed to colloid-in-oil. This latter emulsion differs from the former not only in the visibility of the fat, but in this respect that the fat may be stained (black) by osmic acid or (orange) by sudan III.

"In starvation the fat gradually disappears from the cell leaving the hydrated colloid, which also in time disappears and the cell resumes its shape," p. 211.

"Bone is formed by the deposition of calcium salts in white fibrous tissue. Some bones which are more or less flat, *e.g.*, vault of the skull and the scapula, are formed directly in fibrous tissue. This is the so-called *intra-membranous bone formation*. The long bones are *performed in cartilage into* which processes of fibrous tissue find their way and they in turn undergo calcification. *All bone is developed from fibrous tissue*. The cartilage merely plays the part of scaffolding and is all replaced by fibrous tissue before ossification takes place.

"Practically nothing is known of the physical chemistry of bone formation. Microscopic investigation suggests to our mind a process similar to the formation of a honeycomb. The cells of fibrous tissue detailed to build bone, *i.e.*, osteoblasts, secrete material containing a fair proportion of the phosphate and carbonate of calcium. It is known that the presence of a small quantity of a colloidal complex alters the solubility of inorganic matter. For example, calcium phosphate is more soluble in an albuminous hydrogel than in water. This effect is even more marked with calcium carbonate. If we assume the presence of the salts of lime in the fibrous tissue cells, then, by the principle of Willard Gibbs, they will be found in greatest concentration where the surface tension is lowest, that is at the cell borders. Another factor may be brought into play, *viz.*, alterations in the colloidal matrix. Albumin is broken down in the body to proteoses and peptones. Now, experiment has shown that calcium salts dispersed in an albuminous hydrogel are thrown out of solution when proteoses appear in the gel. Further, calcium phosphate is much more insoluble in proteose-peptone solution than the carbonate, which is only slightly affected by the change. It is significant that bone ash contains about 84 per cent of the former and only 7.6 per cent of the latter salt," p. 212.

"This internal structure is altered to meet alterations in the incidence of stress. For example, during the first twenty years of life when the body is growing and the bone lengthening, constant alterations in internal and external structure have to be made. The unnecessary parts are decalcified and the fibrous tissue undergoes alteration. During this process some of the fibrous tissue cells become enlarged and multinucleated. Histologists call these cells *osteoclasts*. An adjustment to meet altered conditions may be seen when a bone is broken and allowed to set badly, so that its parts lie somewhat out of their former positions. Tension and compression lines do not coincide with the trabecular structure. It has been shown by Wolff and others that in a few weeks, not only has an alteration taken place at the seat of fracture, but *the entire trabecular system right to the ends of the bone, has undergone remodeling to suit the new incidence of forces*. More recent work on bone grafting has amply demonstrated the astonishing rapidity with which reconstruction of the trabecular meshwork takes place. One must remember that in spite of its rigidity, bone is plastic. Physical chemists have proved that when an inorganic constituent separates as a definite phase from a colloidal matrix, the new phase is at first liquid. We may, therefore, infer that the new trabeculae are more or less liquid when formed. The action of force upon them will tend to set them along the lines of that force, *e.g.*, straws set along the direction of the wind. They are practically "carded" into position, where being in equilibrium they will tend to "solidify" in mass," p. 216.

The sensation of sourness is produced when acids penetrate certain cells on the sides of the tongue. The threshold value for sourness does not depend on strength alone. For example, acetic acid, a weak acid is able to affect the cells at a hydrogen ion concentration less than that necessary for strong acids like hydrochloric acid, nitric acid, etc. This is probably due to the greater penetrating power of the weaker acid in an undissociated state. It then dissociates in the cell, liberating hydrogen ions to act on the end-organs, p. 243.

"The primary odours are: (1) flowery (violet); (2) fruity (lemon); (3) spicy (nutmeg); (4) resinous (frankincense); (5) putrid ( $H_2S$ ); and (6) burning (tar). Other olfactory sen-



sations are mixtures of two or more of these, e.g. vanilla = 1 + 2, garlic = 2 + 5, and so on. How do these substances produce a stimulation of the olfactory epithelium? The present idea is that in the gaseous state they produce a series of waves in ether, part of the electromagnetic spectrum, having frequencies much greater than those of light. This is quite plausible, as odorous substances belong almost exclusively to the fifth, sixth and seventh groups of the periodic classification, in which the elements are characterised by the possession of variable valences, i.e. can set free electrons. The "strength" of a smell appears to be related to the speed of rotation of the valence electrons. It is interesting to note that ultra-violet light, which is known to have the property of stabilising these substances by destroying the double bonds in them, also destroys their odour," p. 246.

"The experiments by Gough give a clear indication of the intimate relationship between the red cell and the blood plasma. On removing the last trace of plasma and suspending the red cells in isotonic saline, they assume the spherical form. The addition of serum, however, causes them to reassume their discoid form. The volume of the cell in both forms is the same. Secker showed that *unwashed* corpuscles retained the discoid form in various saline solutions; but the corpuscles became spherical if a small quantity of insulin or if guanidine carbonate solution were added to any of the [saline] solutions. If the saline were isotonic or hypertonic, the sphere had a smaller diameter than the disc. On the other hand, when a hypotonic saline was used, although the sphere was of the same diameter as before, the haemoglobin of these corpuscles diffused out gradually without apparent rupture of the plasma membrane, leaving spherical ghosts," p. 315.

"At high oxygen tensions, the presence of salts and CO<sub>2</sub> in the blood does not materially decrease the percentage saturation of the haemoglobin, but at low oxygen tensions, such as are found in the tissues, it enables much more oxygen to be given off than would be the case in a soluble of pure haemoglobin. . . That is solutes so aid in the unloading of oxygen that fifty percent of the haemoglobin that would otherwise have retained its oxygen is induced to give it up to the tissues. Because of the solutes, whole blood becomes an effective carrier of oxygen, and the total volume of fluid (and mass of haemoglobin) is kept within reasonable limits," p. 328.

"As the heart contracts and dilates it must alternately decrease and increase the intrapleural pressure, causing a slight inrush and outrush of air with each cycle. These cardio-pneumatic movements may be demonstrated in a very simple manner by filling the mouth with tobacco smoke, inserting a glass tube about 18 in. by 1/2 in. in the mouth. Hold the tube vertically (preferably with the upper end gently plugged with cotton wool). Allow a little smoke to enter the tube and then hold the breath. The column of smoke will be seen to pulsate. These movements may be timed with the pulse.

"If a simultaneous record be obtained of the heart beat and of the movements of the air in the external respiratory passages (e.g. nares), it will be seen that there are three phases of the cardiac cycle in which the influence of the heart on the movements of the air column are manifest:—

(1) At the beginning of ventricular systole intrapleural pressure is suddenly increased. At this moment the ventricles are closed cavities.

(2) During ventricular systole intrapleural pressure decreases as systole proceeds.

(3) During ventricular diastole there is a gradual increase of intrapleural pressure.

"These phases may be seen easily in the smoke-filled tube referred to above, viz. (1) smoke-level suddenly rises when the heart beats; (2) smoke level drops, (3) smoke-level slowly rises. During the period of passive diastole the smoke-level remains steady.

"If a bronchitis patient has a plug of mucus in a small air passage near the heart, every time air is forced past the plug by the cardio-pneumatic movements the air will be thrown into vibration, and a murmur will be heard very similar in character to a cardiac murmur.

"It is alleged that the movement of air produced in this way by heart action is quite sufficient to keep up the necessary gaseous exchange in hibernating animals," p. 402.

"The materials not absorbed by the intestine are eliminated by the rectum as the faeces. One suggestive physico-chemical fact about these excreta is the proportion of soap to mass in their make up. It has been found that, normally, fat forms approximately one-third of

the faecal mass (dry). About 10 per cent of this fat is in the form of soap. This may be correlated with the water-holding power of soaps and with their lubricating properties. Somewhere about 80 per cent of their contents is water. This is somewhat remarkable, as both water, fatty acids and soaps are readily absorbed from the gut. If one desires to reduce the water content, calcium is exhibited. As we have already seen calcium soaps are hard "dry" soaps. On the other hand, the addition of easily dissociated sodium and potassium salts leads to the formation of "softer" soaps and a marked increase in the water content of the faeces. It is noteworthy that the fat content (as soap) remains constant. That unabsorbed fat is an excellent faecal lubricant is an axiom in present-day prescribing when mineral oil (liquid paraffin), which cannot be absorbed, is given to produce easy defaecation," p. 419.

Unfortunately, Grotthuss has his name spelled wrong, p. 15 and elsewhere. A more extraordinary aberration is the correct spelling of cathode when discussing electrochemical phenomena, p. 56, and the German spelling of kathode when talking about rays, p. 157. It will evidently take a long time before people substitute solvent for solution in the statement, p. 40, that the osmotic pressure of a substance is numerically equal to the gaseous pressure which this substance would exert were it a gas occupying the same volume as the solution.

*Wilder D. Bancroft*

**A Text-Book of Inorganic Chemistry.** Edited by J. Newton Friend. Vol. X, Part I. 22 × 16 cm; pp. xxviii + 260. London and Philadelphia: Charles Griffin and Company; J. B. Lippincott Company, 1928. Price: \$10.00. In the preface the author, Miss M. M. J. Sutherland, says: "In compiling this volume, "The Metal Ammines," an endeavour has been made to collect the main points relating to this large class of substances. The ammino-derivatives of chromic and cobaltic salts are well known and are included in most text-books on inorganic chemistry whilst those of the other metals are barely touched upon. The ammines are treated in the order in which the metals occur in the periodic system, thus keeping this volume in line with the others of the series," p. xi.

The subject is treated under the following headings: introductory; valency; general characteristics of the metal ammines; metal-ammines of elements of Groups I-VII (seven chapters); metal-ammines of iron, cobalt, and nickel; metal-ammines of ruthenium, rhodium, and palladium; metalammines of osmium, iridium, and platinum.

As the result of examining a large number of metal-ammines, Werner was enabled to arrange this class of substances into well-defined groups. He regarded ammonium chloride as the simplest examples of the ammino-compounds, and represented it by the formula  $H_2N \dots HCl$ . In this, hydrogen is not ionized in solution; but chlorine, being linked by a principal valency bond, undergoes ionization. This view of the formula of ammonium chloride and ammonium salts has not been generally accepted.

"In the metal-ammino compounds or the complex metal salts there is believed to be a definite number of groups or atoms arranged around a central atom. The most usual number is six, but compounds are known where the number is eight, four, or even two. According to the co-ordination theory these atoms or groups are arranged around a central atom united partly by principal and partly by auxiliary valency bonds, such groups constituting the undissociated zone or co-ordination complex.

"Triammino-cobaltic nitrite is not ionized in solution, so that in this particular case the principal valency bonds do not show the characteristics at first laid down for them by Werner. If the substance is treated with ammonia, one, two, or even three of the nitro groups may be replaced by ammonia. The entrance of one molecule of ammonia causes the compound to become ionized, and in solution one ( $NO_2$ ) ion may be detected. Further addition of ammonia causes a second and then a third ( $NO_2$ ) group to pass from the undissociated zone and become ionized in solution," p. 9.

"Three kinds of valency are now recognized, namely:

"1. *Ionised Valency*.—This is exemplified by sodium chloride, the sodium atom functioning as a donor by giving its single-valency electron to the chlorine atom, thereby increasing the number of the outer-shell electrons of this latter atom to eight.

"2. *Co-valency*, in which each of two adjacent atoms shares an electron with the other. The simplest examples of this are afforded by molecules such as  $H_2$ ,  $O_2$ , etc.

"3. *Co-ordinate Valency*, in which two adjacent atoms share a pair of electrons, both of which, however, are supplied by one only of the atoms, namely, the donor, the acceptor atom offering none in return.

"It is a tribute to the prevision of Werner that these developments have not materially affected the essential features of his theory," p. 13.

"Most metallic salts combine with ammonia, forming amines of varying stability. The alkaline earth salts, for instance, unite with ammonia, yielding such compounds as  $\text{CaCl}_2 \cdot 6\text{NH}_3$  and  $\text{CaCl}_2 \cdot 8\text{NH}_3$ , which are known only in the solid state and decompose when dissolved in water. On the other hand, the metals of group eight form amines which are so stable that they may be treated, in many cases, with concentrated acid without removal of ammonia. Between these two classes there are amino-compounds of all grades of stability. Numerous theories have been advanced to account for the different stability of the amines. According to Ephraim, the stability of the metal-amines depends on the atomic volume of the central atom of the complex. He assumes that if the pressure is kept constant the temperature at which decomposition takes place is a measure of the strength of the auxiliary valencies. Experiments were carried out to determine the temperature at which the hexamino-derivatives of the chlorides of the metals beryllium, nickel, cobalt, iron, copper, manganese, zinc, cadmium, and magnesium each exert an ammonia vapour pressure of 500 mm. The results indicated that the temperature decreases as the atomic volume increases. It is therefore assumed that the strength or energy of auxiliary valency is a function of the atomic volume of the central atom of the complex. Similar results were obtained for the hexamino-bromides, iodides, and sulphates," p. 20.

"This type of isomerism is very common in the metal-amines. If two or more different acidic radicles are present in a molecule of metal-amine, the acidic radicles may be firmly fixed in the co-ordination complex or may be outside of this. If they are outside the complex they are easily ionised and easily freed by other acids; if, on the other hand, they are within the complex they are not ionised and are difficult to free by other acids. This distribution of the acidic radicles in the complex, or outside of it, gives rise to ionisation isomerism. For example, the compound  $\text{Co}(\text{NH}_3)_5\text{Br}(\text{SO}_4)$  is known in two forms, one violet and the other red. The violet modification in aqueous solution contains  $\text{SO}_4^{2-}$  ions, which may be precipitated by barium chloride. The red variety gives no  $\text{SO}_4^{2-}$  ions in aqueous solution, and barium sulphate is not precipitated by barium chloride," p. 23.

Tetrammino-cuprous sulphate and monohydrated tetraammino-cuprous sulphate are prepared by reducing ammoniacal cupric sulphate solution with hydroxylamine. The ammine crystallizes in hexagonal plates which are colorless, readily oxidized in air, insoluble in alcohol, and decomposed by water. It is stable up to  $100^\circ$ , but loses ammonia above that temperature, liberating cuprous sulphate, which then decomposes," p. 31.

"Frowein shows by conductivity measurements and by change of colour of the first isomer [of dichloro-aquo-triammino-chromic chloride] that the monaquo-salt gradually passes over to diaquo-salt, and this in turn into the triaquo-salt. The colour of the solution changes from blue to reddish violet and then to red. In all three cases the change is accompanied by increase in conductivity, and the conclusion is that the compounds contain no water outside the inner sphere—that is, they are purely co-ordinated compounds," p. 109.

"Tetrammino-platinous salts are known containing pyridine in place of ammonia. Thus, diammino-dipyridino-platinous salts have been prepared. These salts are interesting, as they exist in isomeric forms, and through them the configuration of the isomeric diacidodiammino-platinous compounds have been determined. It is well known that diacidodiammino-platinum exists in stereo-isomeric forms. These isomers react with two molecules of pyridine in such a manner that pyridine replaces acidic radicles in the complex with formation of diammino-dipyridino-platinous salts," p. 227.

*Wilder D. Bancroft*

*Hydrogen Ions*, By H. T. S. Britton. 22 × 14 cm; pp. xiv + 515. London: Chapman and Hall, 1929. Price: 25 shillings. The accounts given by the author of his own experimental work and the descriptive essays, which he has published from time to time in various scientific and industrial journals, on hydrogen ion concentration and its significance, lead

one to anticipate that this book will contain a readable, useful and well-considered account of the measurement of hydrogen ion concentration and the significance of this factor in various technical processes. The book contains all that could be reasonably expected, indeed it contains more than this; in short the author has produced a clearly written, accurate and well balanced book, in which emphasis is laid in the proper place. It is a book which will find many friends among both academic and industrial chemists. The earlier chapters are devoted to the electrometric determination of hydrogen ion concentration. Here, not only is the necessary theory of the methods explained, but also the various types of standard half-elements, electrode and other instruments, used in the measurements, are described. An excellent chapter on the colorimetric methods of determination of the hydrogen ion concentration follows and this is supplemented by an extremely valuable account of errors which may occur in indicator methods and in the use of indicators in titrations. The principles of electrometric titration are explained as far as they are concerned with acidimetry and alkalimetry. The applications, which occupy about one half the book, commence with a detailed and authoritative account of the precipitation of hydroxides, basic salts, chromates, borates, carbonates, silicates, and phosphates of the metals, in the presence of known and controlled hydrogen ion concentrations. This is an invaluable contribution and will be warmly welcomed by all concerned in the fractional precipitation of such substances, in particular, to mention one case only; it will be of the greatest use to those engaged in the rare earth industry. The author then proceeds to show the importance of the hydrogen ion concentration in electroplating baths, in leather manufacture, chrome and other mineral tanning processes and in vegetable tanning. Individual chapters are devoted to the importance and significance of the hydrogen ion concentration in sugar manufacture, pulp and paper manufacture, brewing, baking, water purification, milk, corrosion, sewage disposal, fertility of soil, ceramics, dyeing, ore flotation, sweets, canned foodstuffs, photographic emulsions, soaps, dentifrices, and petroleum products. The treatment of biochemical and physiological applications, as may be judged from the subjects mentioned, is not overweighted, indeed for a book of this type the author has made a wise choice in the subjects he has treated. The description everywhere in the book is clear, concise and accurate and the method of presentation is admirable.

*James F. Spencer*

*Die anisotropen Flüssigkeiten.* By C. W. Oseen. 25 X 16 cm. pp. 87. Berlin: Gebrüder Borntraeger, 1929. Price: 6.80 reichsmarks. Liquid crystals have a peculiar fascination both for the experimenter and the theorist. The beautiful and unusual phenomena which they exhibit have attracted the attention of many workers and the literature of the subject is already large. X-rays, powerful magnetic fields, and most of the weapons in the armoury of physics have been used in these investigations and have yielded a large amount of information as to the behaviour of these interesting substances under the most diverse conditions. The theoretical interpretation of these observations has also its own special interest for the key to the problem is undoubtedly to be found in the nature of the forces which molecules exert upon one another at small distances. In liquid crystals these forces are large and of a peculiar type; a true and detailed interpretation of the behaviour of these substances should therefore throw some light upon the general laws of force between molecules which is concerned in the theory of the liquid state.

Professor Oseen's valuable monograph is mainly concerned with this theoretical aspect of the subject. The experimental results are first summarised and then the theories. In the first place the theory of Born is outlined, in which the molecules are regarded as simple dipoles playing a part somewhat similar to that of the molecular magnets in Weiss's theory of ferromagnetism. Then follows an account of Oseen's theory in which more complex molecular fields are postulated. The three types of anisotropic liquid, the smectic, the nematic, and the cholesterin type are then discussed in greater detail. It seems clear that the hypothesis of simple dipoles is inadequate and that a great deal of information as to the nature of certain molecular fields can be deduced from the behaviour of liquid crystals.

The paper and printing are of the high standard usually associated with this series of monographs.

*S. Sugden.*

19-14

## THE POLYMORPHISM OF POTASSIUM NITRATE

BY F. C. KRACEK

1. Frankenheim<sup>1</sup> first described correctly the transformations which take place when  $\text{KNO}_3$  crystallizes from its saturated solution. Since the publication of his papers there has appeared much subsequent work dealing with the polymorphic relations of this salt.<sup>2</sup> The most comprehensive investigation on the subject to date is that of Bridgman,<sup>3</sup> who showed that  $\text{KNO}_3$  can occur in four crystalline modifications over the range from  $0^\circ$  to  $200^\circ\text{C}$  and 1 to  $9000 \text{ kg/cm}^2$ , two modifications being stable at ordinary pressure, and two others stable only under high pressures. More recently Roth,<sup>4</sup> and Cohen and Kooy<sup>5</sup> measured the heat of solution of  $\text{KNO}_3$  in  $\text{H}_2\text{O}$  and observed that variable results can be obtained, dependent on the previous thermal history of the salt. This observation has been confirmed by Cohen and Bredée<sup>6</sup> in a very careful investigation of the densities and volume changes on inversion.

Frankenheim (op. cit.) clearly described the conditions for the metastability relations of the low pressure varieties, from observations made on the deposition of crystals from evaporating drops of solution placed under the microscope. The observations were repeated by Mallard<sup>7</sup> and Wallerant<sup>8</sup> and the latter also made an optical study of the recrystallization of dry  $\text{KNO}_3$  employing a microscope equipped with temperature control. The work of Bellatti and Romanese,<sup>9</sup> and Bellatti and Finazzi<sup>10</sup> on the heat of inversion and volume change on inversion of the low pressure varieties is also worthy of special notice.

Employing Bridgman's notation for the various phases, the known facts may be briefly summarized as follows: At ordinary pressure, the low temperature  $\text{KNO}_3$  II inverts directly into the high temperature variety  $\text{KNO}_3$  I in the neighborhood of  $128^\circ$ , with a volume increase of  $0.00483 \text{ cm}^3/\text{g}$ .  $\text{KNO}_3$  II is orthorhombic,  $\text{KNO}_3$  I is rhombohedral, optically uniaxial, negative. On cooling, dry  $\text{KNO}_3$  I inverts, according to Wallerant, at about  $114^\circ$  into a more birefringent form which is also optically uniaxial, and whose optic axes are in the same direction as those of  $\text{KNO}_3$  I. My own experience indicates that this modification is also optically negative, the transformation being characterized by a momentary intensification of twinning bands in the

<sup>1</sup> Frankenheim: *Ann. Physik*, **40**, 447 (1837); **92**, 354 (1854).

<sup>2</sup> The more important references are given in *Int. Crit. Tables*, **4**, **8**, **13** (1928).

<sup>3</sup> Bridgman: *Proc. Am. Acad.*, **51**, 579 (1916).

<sup>4</sup> Roth: *Z. physik. Chem.*, **130**, 539 (1927).

<sup>5</sup> Cohen and Kooy: *Z. physik. Chem.*, **139A**, 273 (1928).

<sup>6</sup> Cohen and Bredée: *Z. physik. Chem.*, **140A**, 391 (1929).

<sup>7</sup> Mallard: *Z. Krist.*, **9**, 398 (1884).

<sup>8</sup> Wallerant: *Bull. Soc. Min., France*, **28**, 311 (1905).

<sup>9</sup> Bellatti and Romanese: *Atti Ist. Veneto*, **1**, 1043 (1883); **3**, 653 (1885).

<sup>10</sup> Bellatti and Finazzi: *Atti Ist. Veneto*, **69**, 1151 (1910).

crystals. Cohen and Bredée noted a parallel phenomenon in that  $\text{KNO}_3$  I<sup>1</sup> (density 2.0337 at 127.00°) on cooling inverts into a "monotropic" variety whose density is considerably higher (2.081 at 124.5°) than that of  $\text{KNO}_3$  II (2.0549 at 127°). They suggest that this modification may be  $\text{KNO}_3$  III, Bridgman's first pressure form. Bridgman pointed out (op. cit. p. 602, also p. 623) that "it might be possible under the proper conditions to realize III at atmospheric pressure as an unstable form," but that "it is plausible, but not necessary, to suppose that this unstable form (referring to Wallerant's observations) is the same as III."

2. *Optical Examination.* The lengthy description given by Frankenheim of the crystallization of  $\text{KNO}_3$  from solution need not be repeated here, but it may be pointed out that it appears to be accurate in every detail. The rhombohedral crystals of the metastable  $\text{KNO}_3$  I are the first to be deposited from an evaporating drop of solution at room temperature. These do not appear to transform spontaneously into the stable orthorhombic prisms of  $\text{KNO}_3$  II, but, in all the cases which I have observed, are perfectly inert in solution until contact is made with a prismatic crystal. Whenever this happens, the surfaces of the rhombohedrons become roughened and prismatic crystals begin to grow rapidly from them. In a solution that is not evaporating too rapidly, a prismatic crystal growing in the direction of a colony of rhombohedral crystals seems to grow at the expense of the latter, which dissolve in the more dilute solution surrounding the prisms. This difference in concentration of the solution can be seen very distinctly as a band of lower refractive index surrounding the orthorhombic prisms of  $\text{KNO}_3$  II. In some cases a large rhombohedron dissolves away locally, forming a cup into which a prism advances. If the recrystallization proceeds so rapidly that the rhombohedrons do not have time to dissolve away and contact is made with a prismatic crystal, the process comes to an end instantaneously; the rhombohedrons become roughened, and are transformed into the prismatic variety.

Slides prepared by melting  $\text{KNO}_3$  on an object glass show the recrystallization substantially as described by Wallerant (op. cit.). When the hot slide with the molten salt covered by a thick glass is allowed to cool under the microscope, very distinct twinning bands are seen in the rapidly growing crystals. These bands gradually fade out as temperature falls. The crystals resulting from the melt are uniaxial, optically negative. At a temperature which appears to be about 125° (see cooling curves of dry  $\text{KNO}_3$ ) a rapid change, accompanied by a momentary intensification of the twinning bands, proceeds along the extinction direction. As soon as this change is complete the twinning bands again fade out partly. The crystal outlines, previously very sharp, have become slightly indefinite. The twinning bands remain parallel to the original, but are displaced in a direction at right angles to the elongation. The new form is still uniaxial and optically negative, but occupies less volume than the high temperature variety. The diminution in volume is noticeable by the appearance of Y shaped cracks in the altered crystals.

<sup>1</sup> Cohen and Bredée denote  $\text{KNO}_3$  II as  $\text{KNO}_3, \alpha$  and  $\text{KNO}_3$  I as  $\text{KNO}_3, \beta$ . The unidentified variety they denote as  $\gamma$ .

At places where the solidified melt is exposed to the air a further change takes place on subsequent cooling, resulting in the formation of the orthorhombic variety,  $\text{KNO}_3$  II, which is stable at room temperature. This last change takes place very slowly. It results in the formation of characteristic feathery crystals oriented in all directions, and showing high interference colors. When a thin cover glass is used, the whole slide usually becomes converted to  $\text{KNO}_3$  II inside of 24 hours. With a thick cover glass the change proceeds exceedingly slowly, so slowly in fact that slides a month old are not always completely altered.

3. *The Scope of this Paper.* The outstanding uncertainty in the interpretation of the known fact regarding the inversions in  $\text{KNO}_3$  lies in the identification of the intermediate form which makes its appearance when  $\text{KNO}_3$  I is cooled. This variety appears to be formed invariably when *dry*  $\text{KNO}_3$  I is cooled, and shows so much reluctance to change into  $\text{KNO}_3$  II that its optical character can be studied at leisure, so long as it is not exposed to the moist laboratory air. The results of Cohen and Bredée afford an apparently valid proof that this modification is metastable at all temperatures at the ordinary pressure, but nevertheless, in view of the reluctant behavior of  $\text{KNO}_3$  II, this does not preclude the possibility that this modification might have a very brief temperature interval of stability near the inversion temperature of  $\text{KNO}_3$  II into  $\text{KNO}_3$  I. It is uncertain whether this variety is identical with Bridgman's  $\text{KNO}_3$  III, or whether it represents a wholly new variety.

In previous papers,<sup>1</sup> Kracek and Gibson<sup>2</sup> have shown that the presence of  $\text{H}_2\text{O}$  in inclusions, or when present as saturated solution in which crystals are immersed, greatly increases the ease with which inversions in  $\text{Na}_2\text{SO}_4$  take place. It was of interest to extend the study of the influence of water on the speed of inversions to  $\text{KNO}_3$ , in an attempt (a) to reduce the hysteresis limits of the inversions, (b) to aid in establishing the stability relations of the phases and (c) in the location of the inversion temperatures.

Bridgman (op. cit.) has experienced considerable difficulty in reducing the width of the pressure bands of hysteresis in establishing the  $P - T$  diagram for  $\text{KNO}_3$  with dry salt; in fact, in the neighborhood of the triple point for  $\text{KNO}_3$  I-II-III the band was approximately  $100 \text{ kg/cm}^2$  wide, so that his value of  $115 \text{ kg/cm}^2$  for the triple point pressure is somewhat uncertain, and, as Cohen and Bredée (op. cit. p. 404) point out, the triple point might lie at a lower pressure than Bridgman estimated. We shall see that the presence of even a small amount of saturated solution helps greatly in establishing this point.

The object of this paper is (a) to establish accurate values of the inversion temperatures and pressures of  $\text{KNO}_3$ , (b) to establish the identity and stability relations of its various phases, particularly in regions of metastable occurrence of the phases, (c) to study the influence of water on the inversions, both at low and at higher pressures.

<sup>1</sup> Kracek: J. Phys. Chem., 33, 1281 (1929).

<sup>2</sup> Kracek and Gibson, J. Phys. Chem., 34, 188 (1930).

### Experimental

4. *Methods of investigation.* Various methods of attack were used in studying the problem. Besides the optical examination mentioned in section 2, differential thermal analysis and dilatometry under pressure were employed. In thermal analysis, determinations were run on both dry and moist samples of  $\text{KNO}_3$ . With the pressure dilatometer only moistened crystals were used, since the behavior of the dry salt has already been studied in sufficient detail by Bridgman (op. cit.) under high pressure, and by Cohen and Bredée (op. cit.) at ordinary pressure.

5. *Differential Thermal Analysis.* The apparatus used for studying the behavior of the dry salt has already been described.<sup>1</sup> It consisted essentially of a specially designed tubular wire-wound electric furnace. In this was placed a removable arrangement carrying the thermocouples for the charge and the neutral body, and baffles, that served to eliminate convection currents. The e.m.f. generated by the thermocouples was measured with a high-sensitivity potentiometer provided with a set of switches so arranged that the temperature of the charge, and the differential temperature between the charge and the neutral body could be balanced as desired. The thermocouples were of Au-Pd/Pt-Rh (40% Pd, 10% Rh), with a sensitivity of approximately  $45\mu\text{v}$  per deg. C in the region under investigation. These were calibrated and used with a specially prepared conversion table.

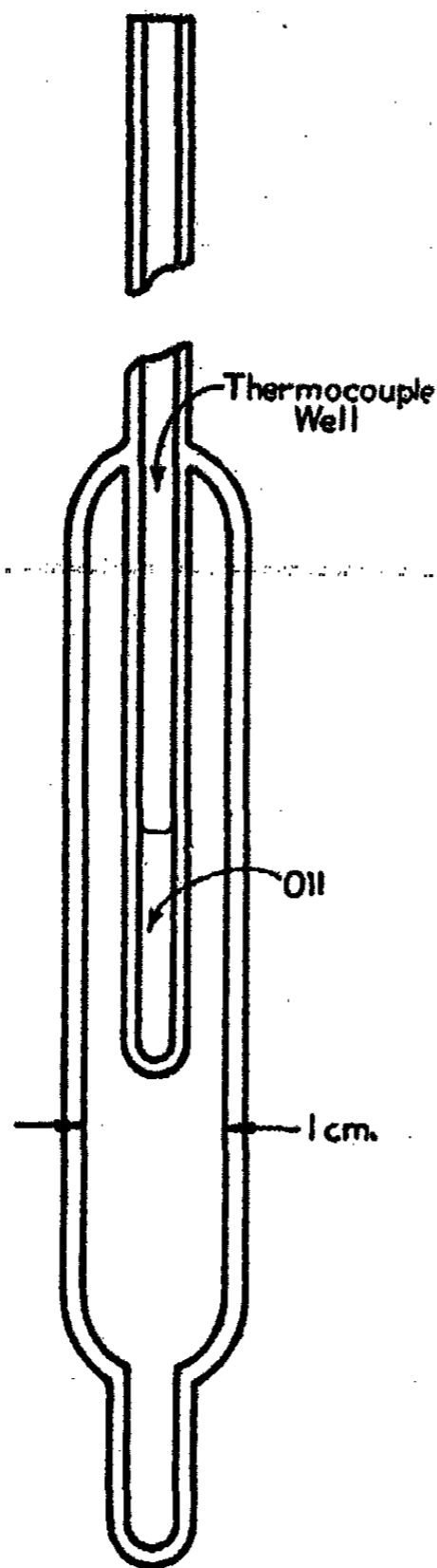

FIG. 1  
Sealed tube, for use in thermal analysis with volatile constituents present.

Thermal analysis experiments on the moistened salt required that the salt be sealed up in a closed tube to prevent the evaporation of the small amounts of  $\text{H}_2\text{O}$  added, since at the temperatures involved the saturated solution of  $\text{KNO}_3$  has a vapor pressure considerably in excess of 1 atmosphere. The tubes were made of Pyrex by R. E. Gibson of this Laboratory, and are of the form shown in Fig. 1. Each tube was provided with a thermocouple-well partly filled with oil to insure good thermal contact. Two similar tubes were used, one filled with an indifferent material and the other with moistened  $\text{KNO}_3$ . They were packed in a tubular electric furnace with asbestos fiber which served to eliminate convection currents.

The method of differential thermal analysis used served a twofold purpose; (a) to establish accurately the temperatures at which the inversions

<sup>1</sup> Kracek: J. Phys. Chem., 33, 1281 (1929).



proceed on heating and on cooling, and (b) to furnish a quantitative measure of the magnitude of the heat effects involved. Data for both purposes can be obtained from each experiment if the weight of the sample employed is known.

The apparatus must be calibrated for use as a radiation calorimeter by heating or cooling in it weighed samples of substances that undergo a phase change in the temperature region in which calorimetric measurements are desired, and whose latent heats are known. The calibration of the apparatus will be described in section 6.

To establish the temperatures at which phase changes proceed the data of differential thermal analysis are plotted in the usual manner, placing the temperature of the charge along the abscissa, and the differential temperature between the charge and the neutral body along the ordinate. The curves thus obtained will be considered in detail in the description of the experimental results.

All necessary precautions were taken to insure reliability of the results. The apparatus was carefully shielded to do away with stray electromotive forces. Storage battery current was used for heating. Rates of heating or cooling were controlled and kept constant, to suit the demands of each experiment, from  $0.15^{\circ}$  to  $0.4^{\circ}$  per minute.

6. *Calibration of the Apparatus for Radiation Calorimetry.* Radiation calorimetry has recently been discussed by White<sup>1</sup> and by Steiner and Johnston,<sup>2</sup> who pointed out some of the essential features of the method. Its principal advantages are simplicity and the ease and speed with which information that would otherwise require a much more elaborate apparatus can be obtained from heating and cooling curves. The method is not as accurate as direct calorimetry can be made, but it compares favorably in accuracy with much of the published work on latent heats at the higher temperatures.

As used in this work, the method consists essentially of measuring the differential temperature-time area due to a phase reaction, upon a differential heating or cooling curve taken with a weighed sample of material. The apparatus used was that mentioned above in section five, for use in studying the behavior of dry salt. It was calibrated at the melting points of benzoic acid ( $121.8^{\circ}$ ),  $\text{AgNO}_3$  ( $208^{\circ}$ ),  $\text{NaNO}_3$  ( $308^{\circ}$ ), and  $\text{KNO}_3$  ( $337^{\circ}$ ), that is, over the temperature range from  $121.8^{\circ}$  to  $337^{\circ}$ . The areas were expressed directly in microvolt-minutes ( $\mu\text{vm}$ ) by counting the mean rise (or fall) in the differential temperature (in microvolts) for each minute from the beginning to the end of the phase reaction. The results of the calibration are given in Table I.

7. *The Pressure Dilatometer.* The pressure dilatometer employed was described by Kracek and Gibson<sup>3</sup> who studied with it the influence of pressure and of moisture on the inversions in  $\text{Na}_2\text{SO}_4$ . It consists of a small

<sup>1</sup> White: "The Modern Calorimeter," (1927).

<sup>2</sup> Steiner and Johnston: *J. Phys. Chem.*, 32, 912 (1928).

<sup>3</sup> *J. Phys. Chem.*, 34, 188 (1930).

steel bomb connected to an Amagat press. In the present work it has been used at pressures up to 300 megabaryes (mb). The steel bomb is immersed in a thermostat which consists of a two-liter Dewar flask filled with mineral oil, heated by current passing through a coil of bare nichrome wire. Temperature could be easily kept constant to within 0.05°C.

The material under investigation is introduced into the bomb in a gold crucible in the manner described by Kracek and Gibson (op. cit.). The

TABLE I  
Calibration of Apparatus for Radiation Calorimetry  
Equation  $F = 2.680 + 0.01617 t$

Calibrating Substance	M. pt. °C	Heat of fusion cal/g	Reaction Area $\mu\text{vm/g}$	Equivalent area $F'$ cal/1000 $\mu\text{vm}$	F calculated from equation	Difference
Benzoic Acid <sup>1</sup>	121.8	33.9	7303	4.64	4.65	+0.01
AgNO <sub>3</sub> <sup>2</sup>	208	17.6	2890	6.08	6.04	-0.04
NaNO <sub>3</sub> <sup>3</sup>	308	44.6	5739	7.77	7.66	-0.11
KNO <sub>3</sub> <sup>3</sup>	337	25.3	3161	8.00	8.13	+0.13

pressure between the bomb and the Amagat press is transmitted by means of highly-refined heavy mineral oil with which the apparatus is completely filled, care being taken to eliminate air bubbles as thoroughly as possible.

The apparatus was carefully calibrated at all essential points.

8. *Materials.* The KNO<sub>3</sub> used was doubly re-crystallized from water, starting with commercial, chemically pure salt. It contained no detectable impurities after recrystallization.

#### Experimental Results and Discussion

9. In presenting the experimental results I shall refer to the various phases of KNO<sub>3</sub> according to the convention adopted by Bridgman (op. cit.), as KNO<sub>3</sub> I, KNO<sub>3</sub> II and KNO<sub>3</sub> III. KNO<sub>3</sub> I is the (rhombohedral) low-pressure phase, stable immediately below the m. pt.; KNO<sub>3</sub> II is the low-temperature (orthorhombic) low-pressure phase; and KNO<sub>3</sub> III Bridgman's first pressure form (rhombohedral?).

10. *Thermal Analysis.* *Granular KNO<sub>3</sub>.* Crushed crystals (ca. 48 mesh) of KNO<sub>3</sub> II, chemically pure except for the presence of minute inclusions of saturated solution, were introduced into the apparatus. The differential heating and cooling curves obtained are pictured in Fig. 2A. The heating curve shows one large heat absorption beginning at ca. 130° and ending at 132.7°, followed by the recovery curve. The cooling curve on the other hand proceeds smoothly on cooling to 124.25°. Nuclei of a new phase formed at this point, and the temperature quickly rose to 124.90°. After the

<sup>1</sup> Lynn: Thesis, Yale (1925).

<sup>2</sup> Guinchant: Compt. rend., 145, 68, 320 (1907).

<sup>3</sup> Recalculated from Goodwin and Kalmus: Phys. Rev., 28, 1 (1909).

reaction finished at *ca.* 123.5° the recovery curve fell regularly until at *ca.* 114° another phase reaction began which then proceeded slowly as the temperature fell. The indications of these curves are completely in accord with the results of optical examination (section 2) and with the dilatometric observations of Cohen and Bredée (*op. cit.*) who found that, on cooling, an intermediate form of  $\text{KNO}_3$  results from  $\text{KNO}_3$  I, and that this inter-

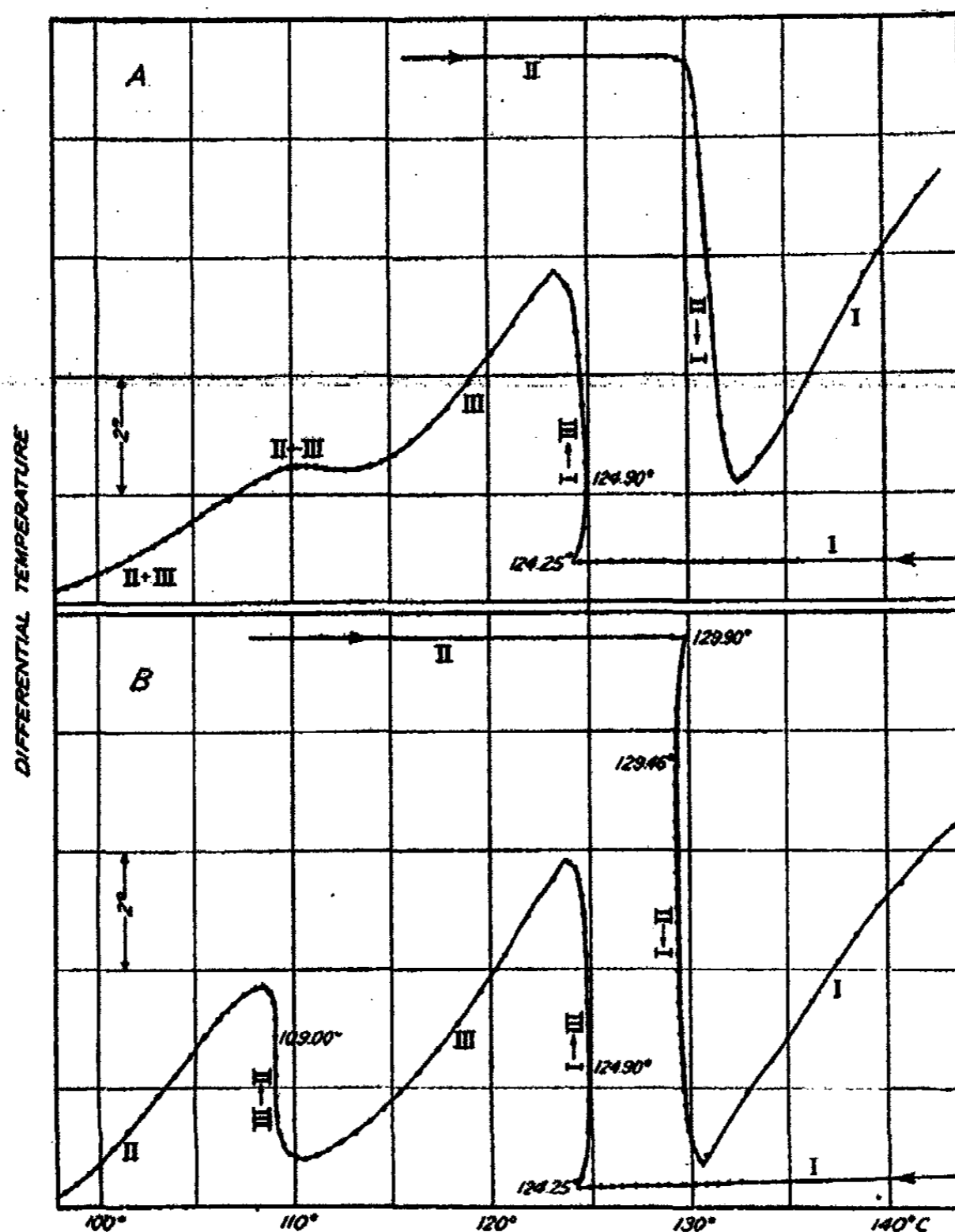

FIGS. 2A and 2B  
Differential heating and cooling curves of dry  $\text{KNO}_3$ , granular.

mediate form does not revert to  $\text{KNO}_3$  II until some temperature below 120° is reached. Estimation of the differential temperature-time areas showed that the heating area is a little greater than the combined areas on cooling. (The recovery curves were in all cases carried to the end of the reaction.)

11. *Broken Block of  $\text{KNO}_3$ .* Re-crystallized  $\text{KNO}_3$  was melted into the crucible, allowed to cool to room temperature, weighed, and introduced into the apparatus. The salt had inverted during cooling, resulting in a tightly

packed mass of crystals of  $\text{KNO}_3$ , II. The curves taken are represented in Fig. 2B. On heating, nucleation began at  $129.90^\circ$ , the temperature then fell to a minimum of  $129.46^\circ$ . The reaction proceeded at practically constant temperature until nearly finished and was then followed by the regular recovery curve. On cooling, nucleation began at  $124.25^\circ$  and the main reac-

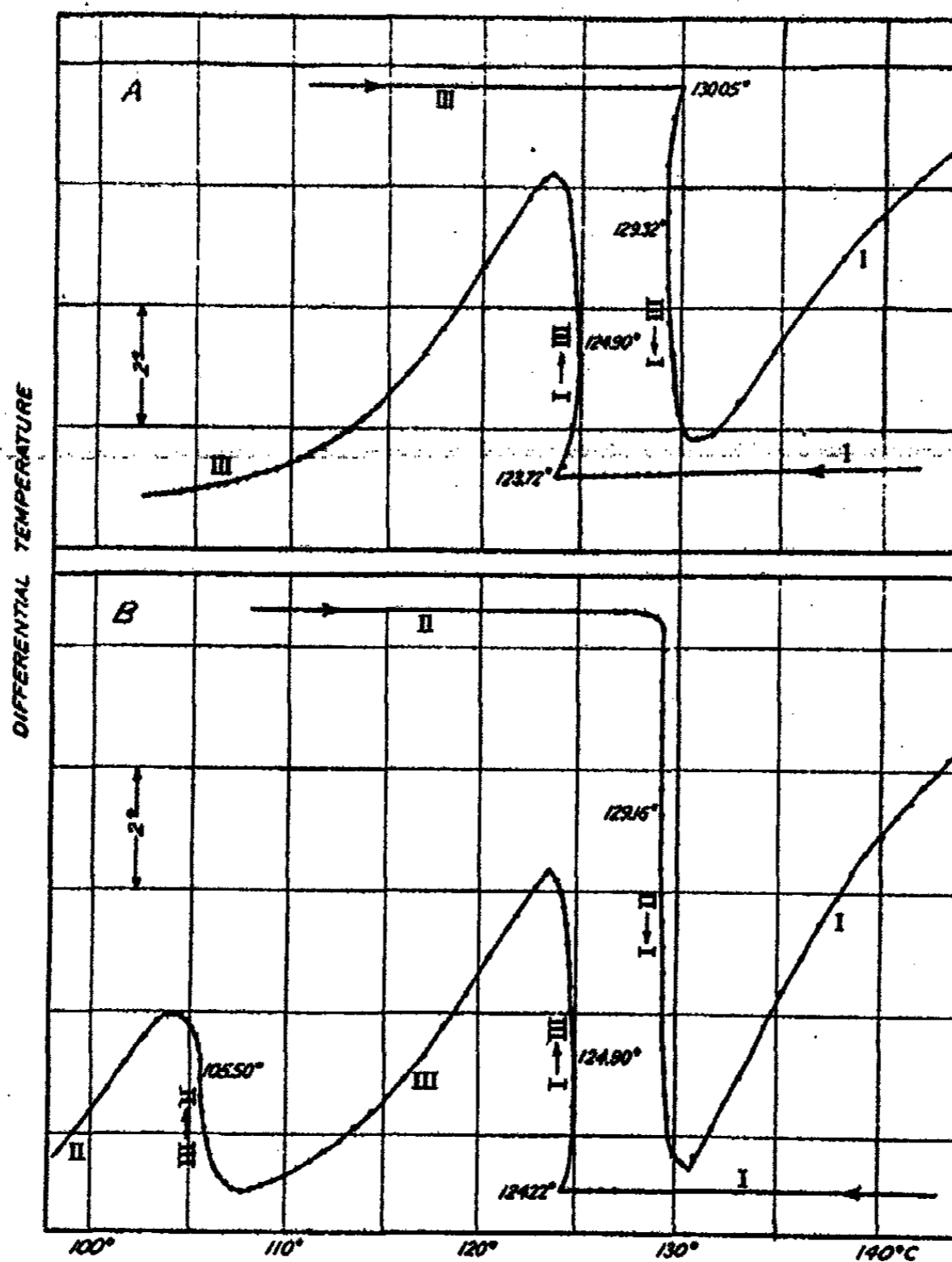

FIGS. 3A and 3B

Fig. 3A. Differential heating and cooling curves on an unbroken block of  $\text{KNO}_3$  (single crystal).

Fig. 3B. Block of Fig. 3A, second cycle of heating and cooling curves. Arrows indicate direction of reaction. Block broke on second cooling.

tion proceeded at a somewhat higher temperature, reaching a maximum of  $124.90^\circ$ . The recovery curve for the intermediate form began sharply and proceeded regularly until a temperature of  $110^\circ$  was reached. A second reaction began at this point, and in this case proceeded at a practically constant temperature of  $109.0^\circ$  till nearly finished. The subsequent recovery curve is somewhat rounded, indicating that although the main part

of the reaction was complete, a little of the intermediate phase was still left when the recovery curve began. The differential temperature-time area on heating was equal to the combined areas on cooling.

12. *Unbroken Block of  $KNO_3$ .* The broken block of the preceding experiment was melted in the furnace. The melt was cooled carefully during

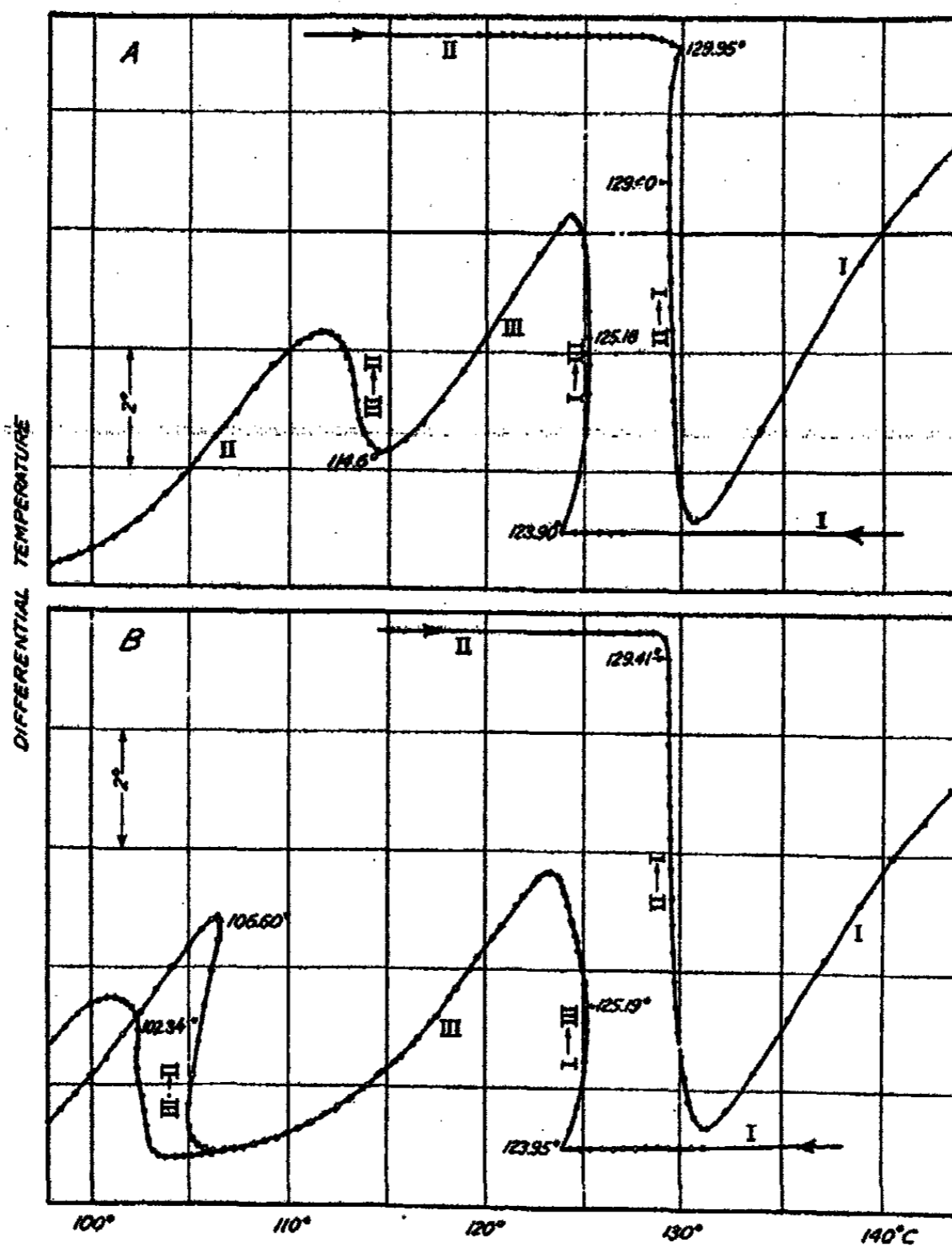

Figs. 4A and 4B

Fig. 4A. Differential heating and cooling curves on another cracked block of dry  $KNO_3$  before remelting in furnace.

Fig. 4B. Block of Fig. 4A after remelting in furnace. Black dots indicate first cooling and reheat. Block cracked on cooling below  $105^\circ$ . Open circles indicate second cooling. Arrows indicate direction of change.

freezing, and the resulting block was then slowly brought to the inversion temperature. Nucleation on the cooling curve began at  $123.72^\circ$  as shown in Fig. 3A. The temperature of the block again rose to  $124.90^\circ$ . After the reaction was finished the recovery curve proceeded regularly as usual, but, although the cooling was not stopped until the temperature fell to  $90^\circ$ , the second heat effect was not obtained. To decide whether the inversion in this

case was to the intermediate form or to the low-temperature form, a heating curve was taken immediately, and showed nucleation at  $130.05^{\circ}$  followed by a fall to the minimum temperature of  $129.32^{\circ}$ . The two differential temperature time areas were equal, but represented only 54% of the ordinary heating area. They were, on the other hand, equal to the area representing the inversion to the intermediate modification.

An attempt to repeat the experiment resulted in curves given in Fig. 3B. In this case the upper reaction on cooling proceeded practically as in Fig. 3A until a temperature of  $108^{\circ}$  was reached, when the block broke and the lower of the two reactions on cooling began. The subsequent heating curve did not show the initial superheating; nucleation began at *ca.*  $129.0^{\circ}$  and the reaction proceeded rapidly at  $129.16^{\circ}$ . The heating differential temperature-time area in this case is equal to the two cooling areas combined.

Figs. 4A and 4B present the results of another attempt to produce a whole unbroken block. Fig. 4A shows the assembly of heating and cooling on a cracked block made by melting the salt into the crucible before introduction into the furnace. Fig. 4B gives the curves obtained after melting in the furnace and careful cooling. The first cooling curve is distinguished by the full circles; the block broke at *ca.*  $103^{\circ}$ . The rounded form of the reaction area shows that the inversion was not yet completed when the temperature had fallen to  $100^{\circ}$ . The second cooling curve, marked with the open circles, is of interest in showing that the inversion from the intermediate to the low temperature form of  $\text{KNO}_3$  can proceed rapidly in some cases. The temperature in this case, after nucleation began at *ca.*  $107^{\circ}$ , first fell to  $105^{\circ}$  and then rose smoothly to  $106.60^{\circ}$ . The recovery curve shows that the reaction was complete when the temperature fell subsequently to  $105^{\circ}$ . The heating areas in Figs. 4A and 4B are equal to each other and to the combined areas of the cooling curves.

13. *Thermal Analysis with Moist  $\text{KNO}_3$  in Sealed Tubes.* About 5 g of dry re-crystallized  $\text{KNO}_3$  II was sealed up with 3 drops of  $\text{H}_2\text{O}$  in one of the tubes described in section 5. This tube was packed in the furnace alongside a similar tube filled with an indifferent substance ( $\text{NaNO}_3$ ).

The heating and cooling curves with the moist  $\text{KNO}_3$  in the sealed tube, shown in Fig. 5, differ radically from those obtained with the dry  $\text{KNO}_3$ . Both the heating and the cooling curves exhibit only one heat effect, in contrast with the two heat effects shown by the cooling curves on the dry salt. Nucleation on heating begins at  $128.15^{\circ}$  and the temperature then falls to  $127.91^{\circ}$ ; on cooling, nucleation temperature is  $126.30^{\circ}$ , followed by a rise to  $127.30^{\circ}$ . The region of indifference is only  $0.61^{\circ}$  as compared with nearly  $6^{\circ}$  for the dry  $\text{KNO}_3$ . The differential temperature-time heating and cooling areas are equal. Because of the difficulty of calibration of the apparatus with the sealed tubes, these heat effects could not be compared with those on dry  $\text{KNO}_3$ . Since, however, the tube was filled with  $\text{KNO}_3$  II and only one heat effect is obtained on heating, and since, further, the heat effect on heating is equal to that on cooling, it seems unobjectionable to conclude that the

same two phases,  $\text{KNO}_3$  II and  $\text{KNO}_3$  I, are concerned in the reaction represented by these curves.

14. If the above conclusion is accepted, a question arises as to the interpretation of the heating and cooling curves with dry  $\text{KNO}_3$ . The phases which are involved in the reaction on heating are unquestionably  $\text{KNO}_3$  II, and  $\text{KNO}_3$  I. On cooling, the phase at temperatures above the upper heat effect is  $\text{KNO}_3$  I, and the phase resulting from the lower heat effect is  $\text{KNO}_3$  II. The intermediate phase is that described in section 2 on optical examination as the uniaxial negative phase which is formed directly from  $\text{KNO}_3$  I on cooling. It remains to prove whether this phase is the same as Bridgman's  $\text{KNO}_3$  III or whether it is an entirely new phase.

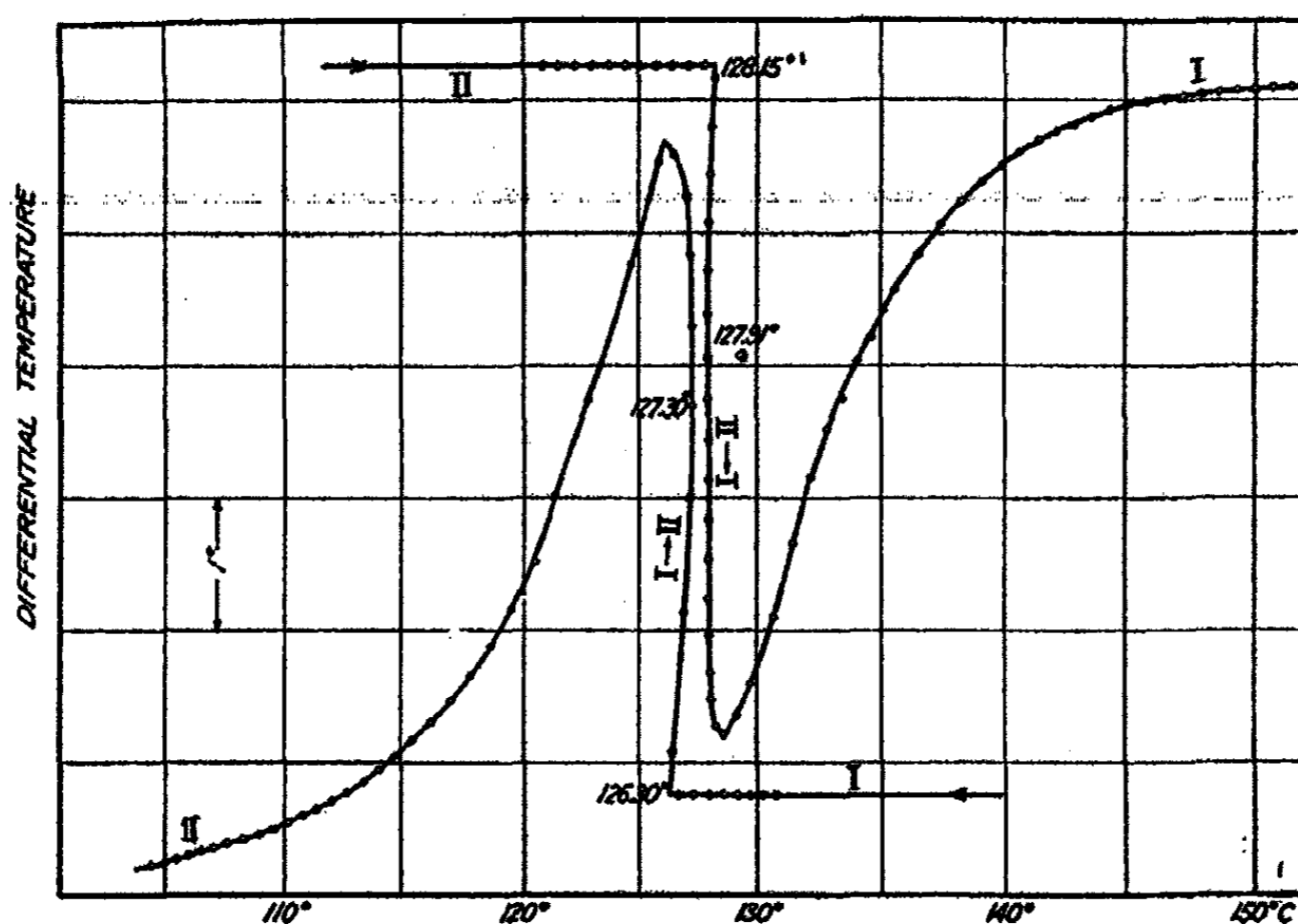

FIG. 5

Differential heating and cooling curves on moist  $\text{KNO}_3$  in sealed tube of Fig. 1. Arrows indicate direction of change.

The results of the heating-and-cooling-curve experiments are collected in Table III in section 22. The discussion of this table will be deferred for the present until the dilatometer experiments are described.

15. *Dilatometer Experiments with Moist  $\text{KNO}_3$  at 50 Megabaryes.* The salt was melted into the gold crucible to eliminate air. After cooling two drops of water were added, the contents of the crucible were covered with oil, sealed in the bomb, and this connected to the press. The pressure of 50 megabaryes (mb) was selected for the first experiment in order to learn whether the stability range of  $\text{KNO}_3$  III extends to this pressure. The results of one set of experiments at this pressure are shown in Fig. 6. The open circles represent points obtained at successively higher constant temperatures, while the black circles give the results with successively lower

temperatures. The temperature was held constant at each point long enough for thorough equalization throughout the apparatus, the gauge being kept adjusted meanwhile at the constant pressure of the experiment, 50 mb in this case.

With rising temperatures first indication of an abnormal change in volume was obtained at  $127.95^{\circ}\text{C}$ . The reaction did not proceed at a very rapid rate, hence the temperature was raised successively until points at  $130.0^{\circ}$  showed that the reaction was complete. The expansion curve with the inverted  $\text{KNO}_3$  was then established by raising the temperature to  $137.64^{\circ}$  and retracing by successively lowering the temperature to  $127.80^{\circ}$ .

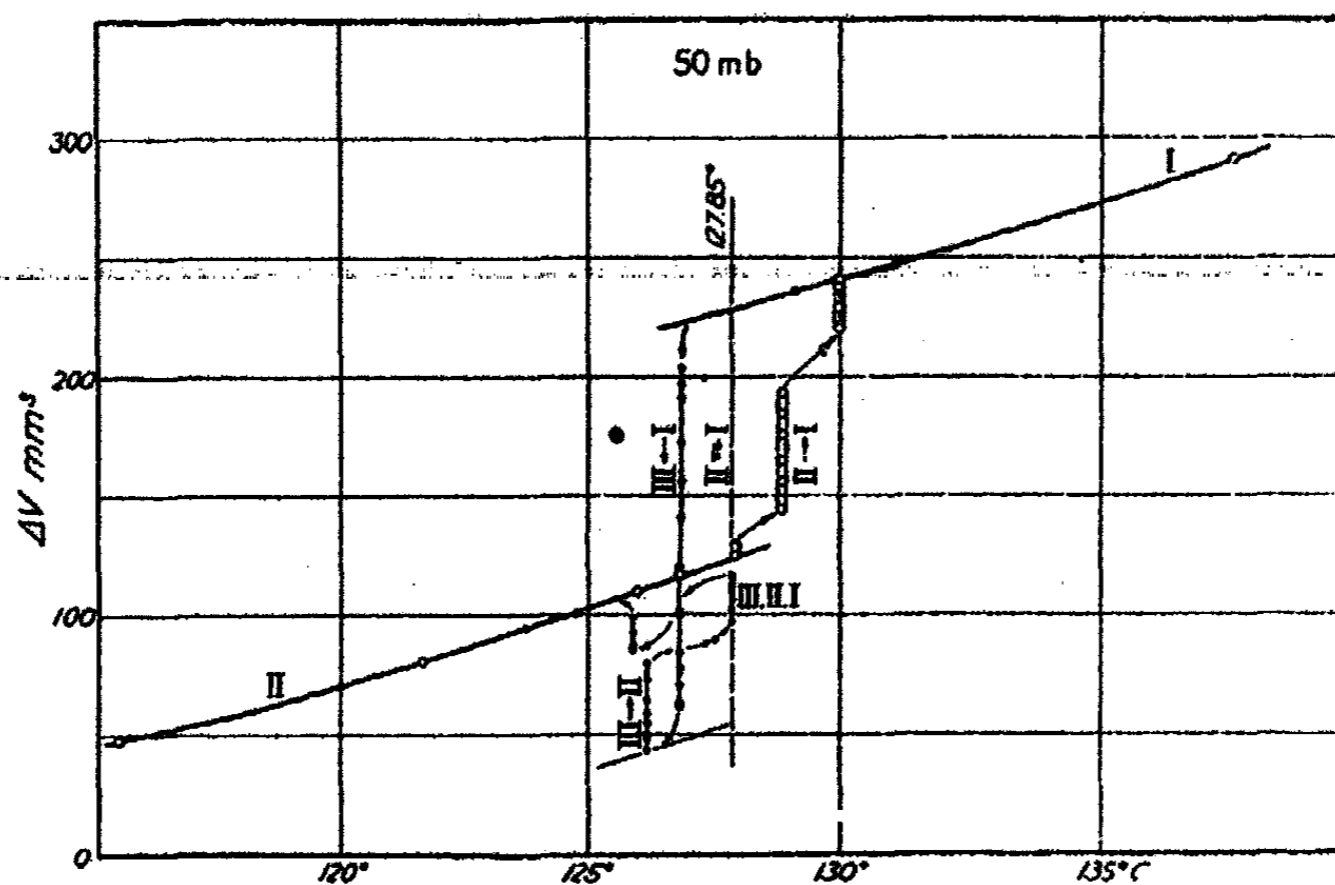

FIG. 6

Dilatometer curves for moist  $\text{KNO}_3$  at 50 mb pressure. Open circles with rising temperatures, black circles decreasing temperatures and reversal.

The phases which take part in the above described reaction are  $\text{KNO}_3$  II and  $\text{KNO}_3$  I. Cohen and Bredée (op. cit.) showed that melted  $\text{KNO}_3$  reverts on cooling to  $\text{KNO}_3$  II. The optical examination (section 2) showed that this does actually take place if the salt is exposed to the moist laboratory air, and that, if solution is present, contact between  $\text{KNO}_3$  II (orthorhombic prisms) and  $\text{KNO}_3$  I (rhombohedral) always results in complete conversion to  $\text{KNO}_3$  II at ordinary temperature. The phase resulting on inversion with rising temperature is beyond doubt  $\text{KNO}_3$  I. The volume change obtained with the rising temperature curve of Fig. 6 is positive, that is, the higher-temperature form has a greater volume than the lower-temperature form. The total volume change measured at  $127.85^{\circ}$ , the inversion temperature for  $\text{KNO}_3\text{II} \rightleftharpoons \text{KNO}_3\text{I}$  at 50 mb, is  $106.0\text{ mm}^3$ . The dilatometer contained 22.456 g of dry  $\text{KNO}_3$  and 0.1025 g of  $\text{H}_2\text{O}$ . Taking into account the solubility of the salt, there remains undissolved in the dilatometer 21.90 g  $\text{KNO}_3$ , which gives the volume change per gram as  $4.84 \times 10^{-3}\text{ cm}^3/\text{g}$ . Another



experiment at 50 mb gave  $(105.5/21.90) \times 10^{-3} \text{ cm}^3/\text{g}$  or  $4.82 \times 10^{-3} \text{ cm}^3/\text{g}$ . These values are in substantial agreement with Cohen and Bredée's value  $4.83 \pm 0.05 \times 10^{-3} \text{ cm}^3/\text{g}$  for  $\text{KNO}_3 \text{ II} \rightarrow \text{KNO}_3 \text{ I}$  obtained with the stabilized dry salt.

The experiment with falling temperatures at 50 mb recorded in Fig. 6 is of interest in that it shows the abnormal volume decrease mentioned by

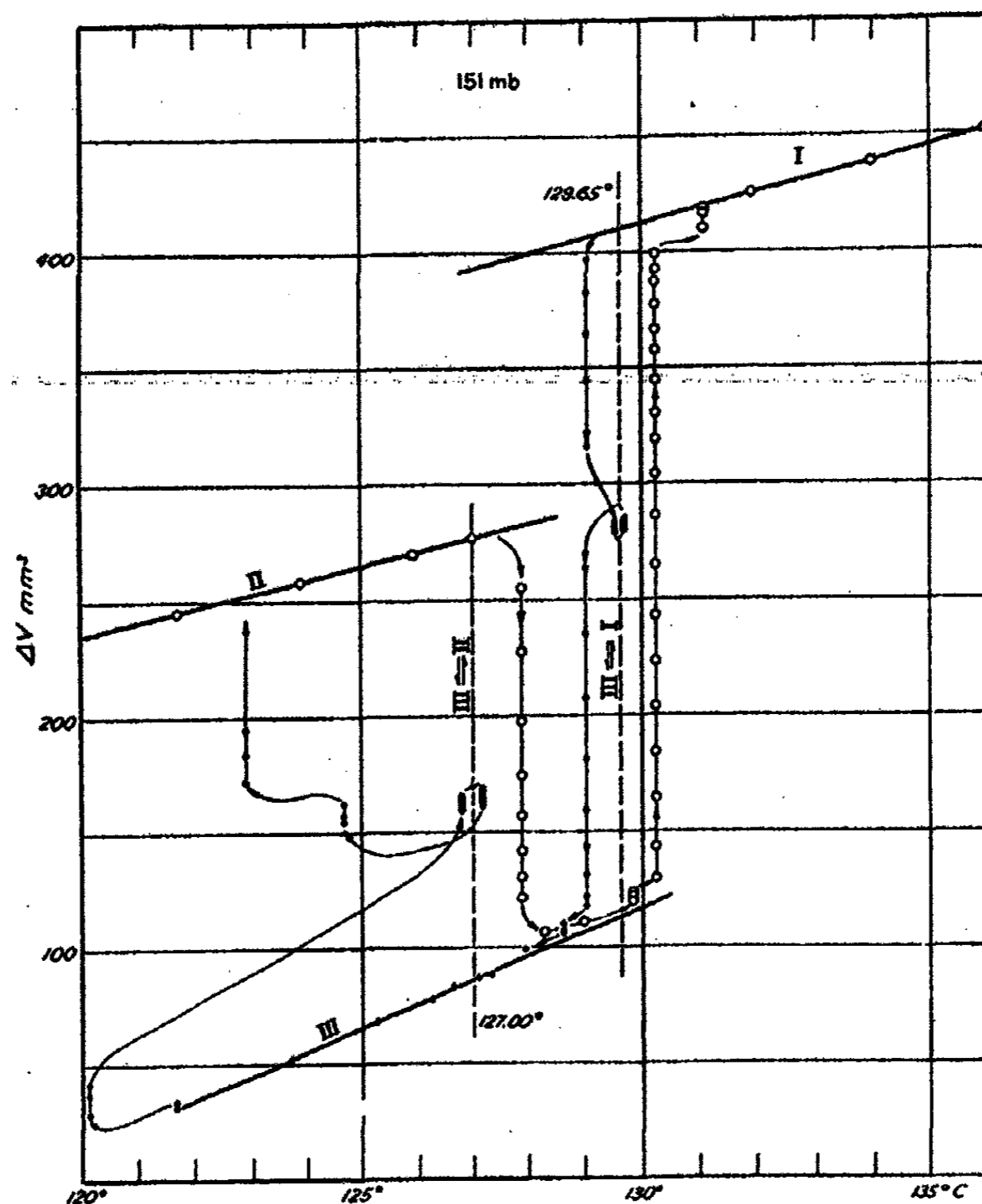

FIG. 7

Dilatometer experiments with moist  $\text{KNO}_3$  at 151 mb pressure. Open circles, rising temperatures; black circles falling temperatures and reversal. Notice the reluctance toward nucleation accompanying the  $\text{III} \rightarrow \text{II}$  change.

Cohen and Bredée. It may be recalled that in the experiment with the sealed tube (section 13) nucleation began at  $126.30^\circ$  and the reaction proceeded rapidly at  $127.30^\circ$  on cooling. In the dilatometer experiment the temperature was lowered to  $126.75^\circ$  and was held constant, pressure being adjusted to 50 mb. A rapid diminution in volume took place beyond the curve for  $\text{KNO}_3 \text{ II}$  until a contraction of  $159 \text{ mm}^3$  (measured at  $127.85^\circ$  on the curve)

was approached. This corresponds to  $7.24 \times 10^{-3} \text{ cm}^3/\text{g}$ . The temperature was then lowered to  $126.2^\circ$ . The volume began to increase slowly, as shown in the figure (Fig. 6). In order to determine if the form of abnormally small volume could be regenerated the temperature was again raised. At  $127.85^\circ$  the volume increase still continued quite rapidly. This is at a temperature at which the speed of the reaction  $\text{KNO}_3 \text{ II} \rightarrow \text{KNO}_3 \text{ I}$  is practically zero, hence the volume increase can not be due to this reaction. Lowering the temperature again, to  $125.9^\circ$  this time, the volume increase still continued,

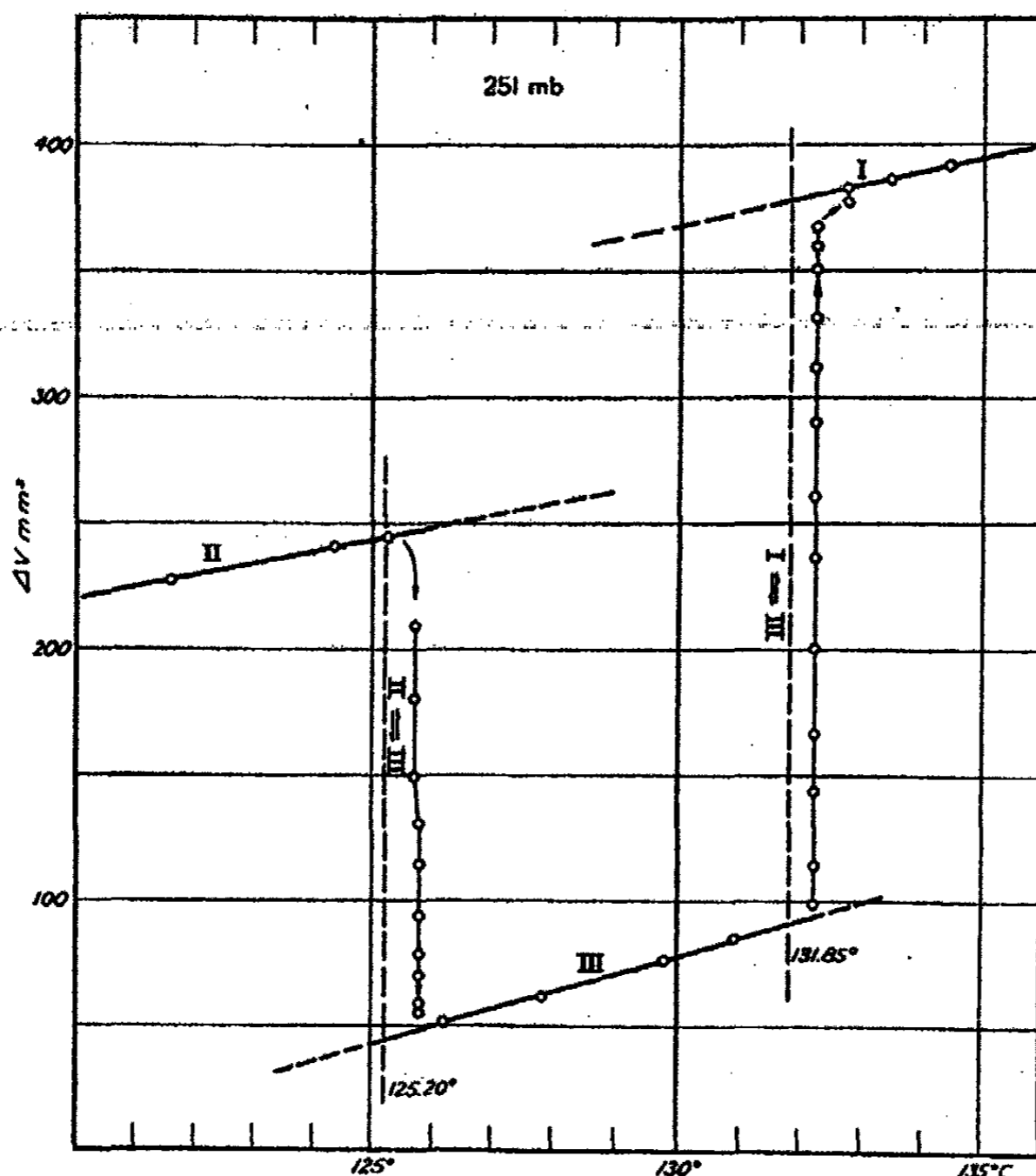

FIG. 8  
Dilatometer experiments with moist  $\text{KNO}_3$  at 251 mb.  
The curve at rising temperatures only is shown.

ending on the expansion line for  $\text{KNO}_3 \text{ II}$ . This experiment proves that in moist  $\text{KNO}_3$  the variety with the abnormally small volume is metastable at all temperatures. Its inversion to  $\text{KNO}_3 \text{ II}$  is truly monotropic. In view of the much greater speed of reaction with moist salt than with dry salt, the present demonstration of the monotropic nature of this inversion is conclusive (Cohen and Bredée: *op. cit.* pp. 402-4).

In another experiment at 50 mb the abnormal volume decrease amounted to  $6.55 \times 10^{-3} \text{ cm}^3/\text{g}$ . Cohen and Bredée's experiments yield approximately

$6.9 \times 10^{-3} \text{cm}^3/\text{g}$  at  $124.5^\circ$ . No value can actually be attached to these figures since the metastable form is not in equilibrium when the abnormal volume decrease ceases.

16. *Dilatometer Experiments at 151 mb.* A record of measurements made at 151 mb is given in Fig. 7. In this case  $\text{KNO}_3$  II inverted first to  $\text{KNO}_3$  III with rising temperatures, and then on further increase in temperature  $\text{KNO}_3$  III inverted to  $\text{KNO}_3$  I. The equilibrium inversion temperatures were established, as shown by the reversing loops, as  $127.00^\circ$  for  $\text{KNO}_3 \text{ II} \rightleftharpoons \text{KNO}_3 \text{ III}$ , and  $129.65^\circ$  for  $\text{KNO}_3 \text{ III} \rightleftharpoons \text{KNO}_3 \text{ I}$ . The volume change for  $\text{KNO}_3 \text{ II} \rightarrow \text{KNO}_3 \text{ III}$  is negative and equal to  $8.66 \times 10^{-3} \text{cm}^3/\text{g}$ ; that for  $\text{KNO}_3 \text{ III} \rightarrow \text{KNO}_3 \text{ I}$  is positive, and has the value  $13.4 \times 10^{-3} \text{cm}^3/\text{g}$ . These figures are not exact because of the uncertainty involved in the solubility correction, but they are of the same sign and order of magnitude as those given by Bridgman (op. cit.) for these reactions.

An interesting variation in the results is shown by the reluctance with which nucleation of  $\text{KNO}_3$  II starts after complete conversion to  $\text{KNO}_3$  III during cooling. In the experiment at 151 mb in Fig. 7 temperature had to be lowered to nearly  $120^\circ$  before  $\text{KNO}_3$  III inverted to  $\text{KNO}_3$  II with even moderate speed. After nuclei of  $\text{KNO}_3$  II were formed the reaction on raising the temperature proceeded with sufficient speed to make it possible to determine the equilibrium point.

17. *Dilatometer Experiments at 251 mb.* The curves of Fig. 8 present the record obtained with rising temperatures at 251 mb.  $\text{KNO}_3 \text{ II} \rightleftharpoons \text{KNO}_3 \text{ III}$  occurs at  $125.20^\circ$ ; the volume change is negative,  $9.12 \times 10^{-3} \text{cm}^3/\text{g}$ . The equilibrium point for  $\text{KNO}_3 \text{ III} \rightleftharpoons \text{KNO}_3 \text{ I}$  is  $131.85^\circ$ , the volume change being positive and equal to  $13.3 \times 10^{-3} \text{cm}^3/\text{g}$ . These volume changes compare favorably with those obtained at 151 mb. No record is given in the figure to show the transformations with falling temperatures; it was again necessary to cool far below the corresponding inversion temperature before nuclei of  $\text{KNO}_3$  II were obtained from  $\text{KNO}_3$  III.

18. Comparison of the results obtained at 151 mb and 251 mb with those at 50 mb leads to the conclusion that the wholly metastable phase at 50 mb is identical with  $\text{KNO}_3$  III. The volume change on inversion of  $\text{KNO}_3$  I to this phase is negative and in the same direction as that on inversion to  $\text{KNO}_3$  III at the pressures at which the latter is stable. The conversion of  $\text{KNO}_3$  I to the metastable phase at 50 mb yields a volume change of ca.  $7 \times 10^{-3} \text{cm}^3/\text{g}$  compared with  $13.4$  and  $13.3 \times 10^{-3} \text{cm}^3/\text{g}$  obtained at 151 and 251 mb in my experiments and  $14 \times 10^{-3} \text{cm}^3/\text{g}$  given by Bridgman for the I  $\rightarrow$  III inversion. This apparent discrepancy offers no valid objection to the argument, since the metastable phase at 50 mb quickly changes to  $\text{KNO}_3$  II which has a greater specific volume than  $\text{KNO}_3$  III. The measured volume change in this case must of necessity be less than when  $\text{KNO}_3$  I inverts to  $\text{KNO}_3$  III in a region in which the latter is stable, and in which disturbances due to formation of  $\text{KNO}_3$  II, before complete conversion of  $\text{KNO}_3$  I to  $\text{KNO}_3$  III, are absent.

The metastable occurrence of  $\text{KNO}_3$  III in the moist salt at 50 mb and in the thermal analysis experiments with dry  $\text{KNO}_3$ , as well as in the dilatometer experiments reported by Cohen and Bredée (op. cit.) is paralleled by the reluctance with which nuclei of  $\text{KNO}_3$  II form in  $\text{KNO}_3$  III at 151 and 251 mb. A possible explanation for this behavior may be based on the optical result that  $\text{KNO}_3$  II, which is orthorhombic and hence biaxial, differs con-

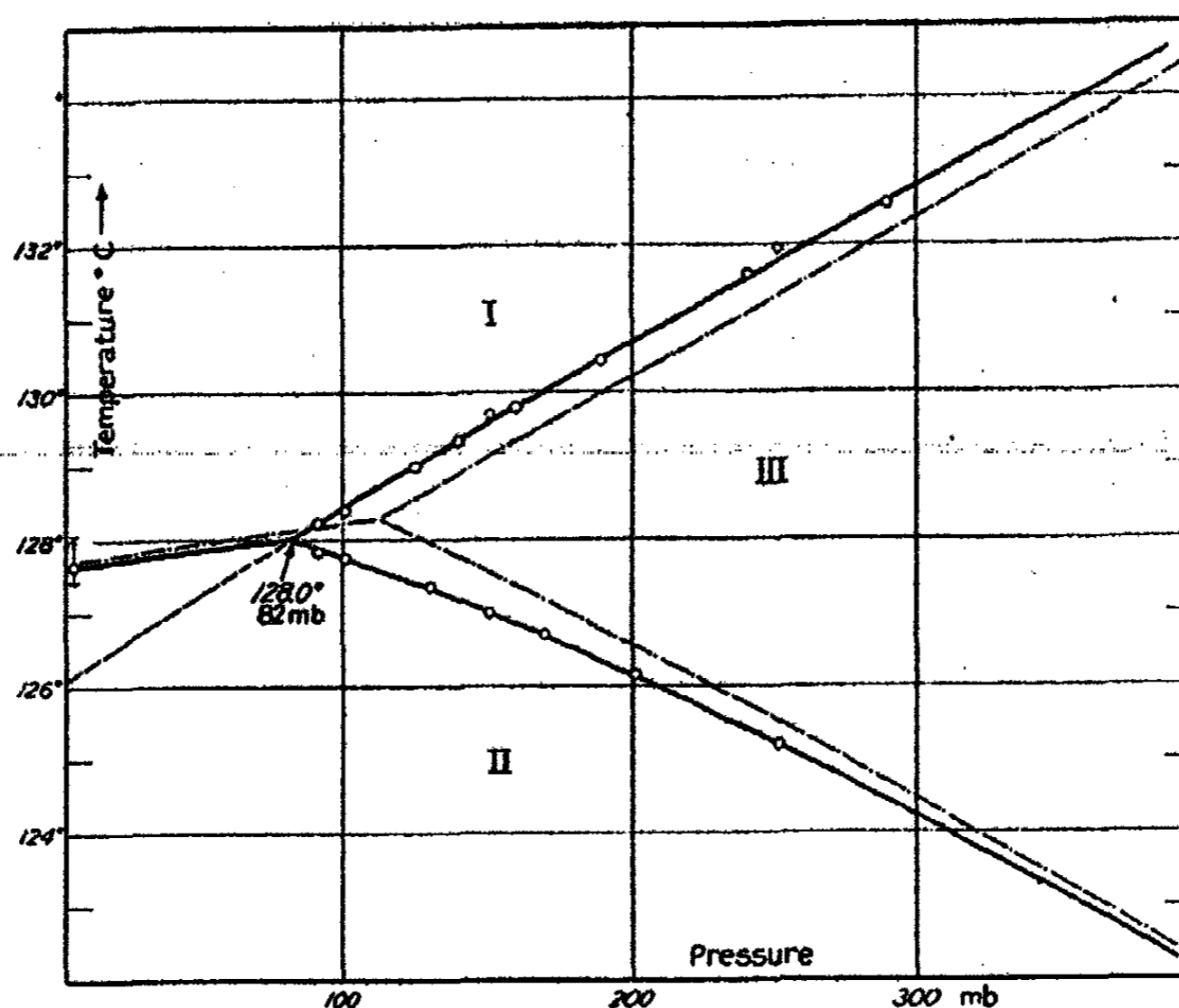

FIG. 9

The pressure-temperature diagram for  $\text{KNO}_3$ , with moist salt. Bridgman's diagram for dry salt is indicated by the broken lines.

siderably from the uniaxial and optically negative varieties  $\text{KNO}_3$  I and the intermediate form which we need no longer distinguish from  $\text{KNO}_3$  III. This difference in crystal properties argues for a greater difficulty of conversion from  $\text{KNO}_3$  I or  $\text{KNO}_3$  III to  $\text{KNO}_3$  II than for the mutual conversion between I and III.

19. *The Pressure-Temperature Diagram for  $\text{KNO}_3$ .* Comparison of the equilibrium inversion temperatures obtained at 151 and 251 mb (sections 14 and 15) with the corresponding values interpolated from Bridgman's work (op. cit.) indicated a need for a re-determination of the inversion curves, particularly in the neighborhood of the triple point, which according to Bridgman is at 128.3° and 115 kg/cm<sup>2</sup> (112.8 mb).

The same sample of moist  $\text{KNO}_3$ , used in the preceding experiments, was employed in this work. The temperature and pressure were adjusted until the motion of the dial hand on the pressure gauge indicated that two phases

were present in the sample; the pressure at which a determination was desired was then selected and kept constant while the temperature was successively raised and lowered about a point until limits were established between which the reaction proceeded with only negligible speed. Particular attention was given to the constancy of temperature at each stopping point, and enough time was given to insure complete equalization both of temperature and pressure throughout the apparatus. In most cases several successive determinations were performed on the same pair of coexisting solid phases at various pressures. In other cases a determination was made at constant pressure, first for one pair of phases, then for the second pair. Care was taken to insure the presence of a sufficient quantity of each phase to eliminate difficulties accompanying the formation of nuclei of the new phase. Several experiments were also made to determine (a) the speed with which the reactions proceed, and (b) the width of the pressure band. The latter was between 5 and 10 mb for  $\text{KNO}_3 \text{ II} \rightleftharpoons \text{KNO}_3 \text{ III}$  and between 2 and 3 mb for  $\text{KNO}_3 \text{ I} \rightleftharpoons \text{KNO}_3 \text{ III}$ , in comparison with a width of about 100 kg/cm<sup>2</sup> in Bridgman's experiments in the neighborhood of the triple point. No quantitative data of absolute significance can be given for the speeds of the reactions, but it may be mentioned that for the same pair of phases the reaction proceeding with a decrease in volume had the greater speed, e.g., the speed of  $\text{KNO}_3 \text{ II} \rightarrow \text{KNO}_3 \text{ III}$  is greater than that of  $\text{KNO}_3 \text{ III} \rightarrow \text{KNO}_3 \text{ II}$ . With  $\text{KNO}_3 \text{ II} \rightleftharpoons \text{KNO}_3 \text{ III}$  at least two hours were needed for the gauge to come to a standstill, compared with about 30 minutes required for the reaction  $\text{KNO}_3 \text{ I} \rightleftharpoons \text{KNO}_3 \text{ III}$ .

The results of these experiments are collected in Table II and are represented graphically in Fig. 9. The figure also shows Bridgman's diagram by the dot and dash curves. The newly determined triple point for the coexistence of  $\text{KNO}_3 \text{ I}$ ,  $\text{KNO}_3 \text{ II}$  and  $\text{KNO}_3 \text{ III}$  is at 128.02° and 82.0 mb.

TABLE II  
Experimental Equilibrium Pressures and Temperatures  
for the Phase Diagram of  $\text{KNO}_3$

$\text{KNO}_3 \text{ I} \rightleftharpoons \text{KNO}_3 \text{ III}$		$\text{KNO}_3 \text{ II} \rightleftharpoons \text{KNO}_3 \text{ III}$	
Pressure in mb	t°C	Pressure in mb	t°C
91.0	128.23 ± 0.05	91.0	127.85 ± .05
101.0	128.40	101.0	127.75
125.0	129.00	130.0	127.35
140.0	129.35	151.0	127.00
151.0	129.70	170.0	126.70
160.0	129.80	201.0	126.15
190.0	130.45	251.0	125.20
240.0	131.60		
251.0	131.95		
290.0	132.55		

20. *Calorimetric Results.* The equivalent area  $F$  of the radiation calorimeter calibration in Table I for  $127.6^\circ$ , the inversion temperature of  $\text{KNO}_3$  I  $\text{KNO}_3$  II, is  $4.743 \text{ cal}/1000 \mu\text{m}$

The average area for  $\text{KNO}_3$  II  $\rightarrow$   $\text{KNO}_3$  I and  $\text{KNO}_3$  I  $\rightarrow$   $\text{KNO}_3$  III  $\rightarrow$   $\text{KNO}_3$  II from all the experiments on thermal analysis (section 10, 11 and 12) is  $2212 \mu\text{m}/\text{g}$ , or  $10.49 \text{ cal}/\text{g}$ . Bellatti and Romanese (op. cit.) gave  $11.89 \text{ cal}/\text{g}$ ; Bridgman estimated  $11.6 \text{ cal}/\text{g}$  at  $1 \text{ kg}/\text{cm}^2$  from his value of the change in the inversion temperature with pressure using an inaccurate value of the volume change on inversion, and  $10.33 \text{ cal}/\text{g}$  at the triple point employing a better value of the volume change.

The average differential temperature-time area for  $\text{KNO}_3$  I  $\rightleftharpoons$   $\text{KNO}_3$  III reaction is  $1163 \mu\text{m}/\text{g}$  or  $5.52 \text{ cal}/\text{g}$ . No direct calorimetric determination of this quantity exists. Bridgman gave  $6.11 \text{ cal}/\text{g}$  for this reaction at  $1 \text{ kg}/\text{cm}^2$ .

The difference between the two above values is  $4.97 \text{ cal}/\text{g}$  and represents the heat of inversion of  $\text{KNO}_3$  II  $\leftarrow$   $\text{KNO}_3$  III at ordinary pressure. Bridgman's values for this reaction extrapolated to  $1 \text{ kg}/\text{cm}^2$  yield  $4.65 \text{ cal}/\text{g}$ .

21. *The Inversion Temperature for  $\text{KNO}_3$  I  $\rightleftharpoons$   $\text{KNO}_3$  II at 1 mb.* From the newly determined value of the triple point,  $128.02^\circ$  the volume change of  $4.84 \times 10^{-3} \text{ cm}^3/\text{g}$  and heat of inversion of  $10.49 \text{ cal}/\text{g}$  for the II  $\rightleftharpoons$  I inversion we obtain, for the rise in the inversion temperature with pressure, from the Clapeyron equation.

$$\begin{aligned} \frac{dt}{dp} &= \frac{T\Delta V}{\Delta H} = \frac{(128.02 + 273.10)(4.84 \times 10^{-3}) \text{ deg. cm}^3}{10.49 \times 4.186 \times 10^7 \text{ dyne cm}} \\ &= 4.42 \times 10^{-9} \text{ deg. cm}^2/\text{dyne} = 4.42 \times 10^{-3} \text{ deg}/\text{mb}. \end{aligned}$$

The rise of the inversion temperature for 81 mb (triple point pressure = 82 mb) is  $0.36^\circ$ ; consequently, the inversion temperature at 1 mb is  $128.02^\circ - 0.36^\circ = 127.66^\circ$ . The sealed tubes (see Table III) gave  $127.33^\circ$  and  $127.98^\circ$  as the average hysteresis limits, mean  $127.66^\circ$ .

22. *Hysteresis accompanying the Inversions.* Table III contains the collected results of thermal analysis on both dry  $\text{KNO}_3$  and the moist salt in sealed tubes. In describing these experimental results in sections 10-14, I have referred to  $\text{KNO}_3$  III as the intermediate phase, its identity being still undecided at that point. The considerations of sections 18-20 prove beyond doubt that this intermediate phase is  $\text{KNO}_3$  III, so that this distinction need no longer be made. The phases are accordingly given their proper designations in Table III.

It follows from Table III that the dry  $\text{KNO}_3$  II  $\rightarrow$   $\text{KNO}_3$  I reaction takes place in blocks at  $129.5 \pm 0.2^\circ$ ,  $\text{KNO}_3$  I  $\rightarrow$   $\text{KNO}_3$  III at  $125.1 \pm 0.2^\circ$  and  $\text{KNO}_3$  III  $\rightarrow$   $\text{KNO}_3$  II at various temperatures between  $115^\circ$  and  $100^\circ$ . In none of the experiments with the dry salt has it been possible to obtain a direct inversion of  $\text{KNO}_3$  I to  $\text{KNO}_3$  II on cooling; the reaction proceeds always in two steps,  $\text{KNO}_3$  I  $\rightarrow$   $\text{KNO}_3$  III and  $\text{KNO}_3$  III  $\rightarrow$   $\text{KNO}_3$  II. The reversal of the metastable phase reaction  $\text{KNO}_3$  III  $\rightleftharpoons$   $\text{KNO}_3$  I goes at  $129.32^\circ$

TABLE III  
Results of Differential Thermal Analysis on  $\text{KNO}_3$

Material	$\text{KNO}_3\text{II} \rightarrow \text{KNO}_3\text{I}$		$\text{KNO}_3\text{I} \rightarrow \text{KNO}_3\text{III}$		$\text{KNO}_3\text{III} \rightarrow \text{KNO}_3\text{II}$	
	Nucleation $t^\circ\text{C}$	Reaction	Nucleation $t^\circ\text{C}$	Reaction	Nucleation $t^\circ\text{C}$	Reaction
Dry, granular	> 129.0	> 130.0	124.25	124.90	< 114	113-110
Dry, broken block before remelting.	129.90 130.0 129.90 129.95	129.46 129.77 129.64 129.40	124.25 124.3 124.5 123.9	124.90 125.43 125.45 125.18	110 114.7 114.5	109.0 114-111 114-111
Dry, broken block after remelting in furnace.	> 129.0 > 129.0	129.16 129.41	124.22 123.95 123.95	124.90 125.19 125.19	108 103 106-105	105.5 102.3 106.6
Dry, unbroken block after remelting in furnace.			123.72 130.05	124.90 (cooling) 129.32 (heating)		
Moist in, sealed tube	128.15 128.14 128.15 128.13 128.12 128.15 128.12 Ave.	127.91 (heating) 128.02 128.02 127.93 128.02 127.98 128.00 127.98				
	126.30 126.45 126.35 Ave.	127.30 (cooling) 127.26 127.42 127.33				

on heating and at  $124.90^\circ$  on cooling in the experiment with the unbroken block. When water is present, there is a direct reversal between  $\text{KNO}_3$  I and  $\text{KNO}_3$  II, the hysteresis limits being, on the average,  $127.98 \pm 0.05^\circ$  on heating, and  $127.33 \pm 0.08^\circ$  on cooling.

The above values may be compared with the data obtained from the pressure experiments. Extrapolation from the triple point with the aid of the slope of the inversion line for the  $\text{KNO}_3$  I  $\rightleftharpoons$   $\text{KNO}_3$  II transformation gives  $127.66 \pm 0.05^\circ\text{C}$  as the inversion temperature for this reaction at 1 mb pressure, in agreement with the mean of the hysteresis limits,  $127.66 \pm 0.05^\circ$ , with the moist salt in the sealed tubes.

Extrapolation of the  $\text{KNO}_3$  I  $\rightleftharpoons$   $\text{KNO}_3$  III pressure curve through the triple point to 1 mb gives  $126.1^\circ$  for the metastable equilibrium value of the inversion temperature for this transition, compared with the above mentioned hysteresis limits of  $124.90^\circ$  on cooling and  $129.32^\circ$  on heating.

The delayed appearance of phase II on cooling, at temperatures below  $115^\circ$  in dry  $\text{KNO}_3$ , further emphasizes the difficulty of growth of this phase from  $\text{KNO}_3$  I or  $\text{KNO}_3$  III, already mentioned in section 18.

The accelerating influence of water on the speed of the inversions is completely in accord with the results obtained by Kracek and Gibson (op. cit.) on the behavior of moist  $\text{Na}_2\text{SO}_4$ . In  $\text{KNO}_3$  under pressure the presence of  $\text{H}_2\text{O}$  reduces the hysteresis band from a width of approximately 100 mb stated by Bridgman (op. cit.) for the dry salt, to about 3 mb and 7 mb for the two high pressure curves in the neighborhood of the triple point. In the sealed tubes the behavior is still more remarkable.  $\text{KNO}_3$  II is thus enabled to grow directly from  $\text{KNO}_3$  I at the nucleation temperature of ca.  $126.4^\circ\text{C}$  (Table III), while totally unable to grow from  $\text{KNO}_3$  I directly in the dry state.

It is to be emphasized that in nearly all the thermal analysis experiments (Table III) the nucleation temperatures are further removed from the equilibrium points than the temperatures at which reactions proceed after nuclei of a new phase are present; i.e., on heating, there is a superheating of the phase originally present, followed by a fall of temperature to the upper hysteresis limit. It is interesting to note that the upper hysteresis limit is *not lowered appreciably by slowing up the rate of heating*. A sample of dry  $\text{KNO}_3$  was heated in one experiment at  $0.15^\circ$  per minute, and in another at  $3^\circ$  per minute; the temperatures at which the salt inverted rapidly were  $129.47^\circ$  and  $129.48^\circ$  respectively. The same holds for the lower hysteresis limit. The reaction speed is certainly negligibly small over the whole width of the hysteresis band, and increases very rapidly when the hysteresis limits are reached. This is in good accord with the thermodynamic argument advanced by Kracek in the discussion of the hysteresis phenomena exhibited by the  $\text{Na}_2\text{SO}_4$  inversions.<sup>1</sup> The thesis of the argument there offered was that inversions proceed with appreciable speed only at temperatures so far removed from the equilibrium point that the difference between the thermo-

<sup>1</sup> Kracek: J. Phys. Chem. 33, 1281 (1929).



dynamic potential energies of the two phases concerned in the reaction has attained a sufficiently large value to overcome the internal friction. On atomistic grounds this internal friction is obviously represented by the opposing forces of constraint, which come into play during rearrangement of the atoms from the positions occupied in one space lattice to those in another,

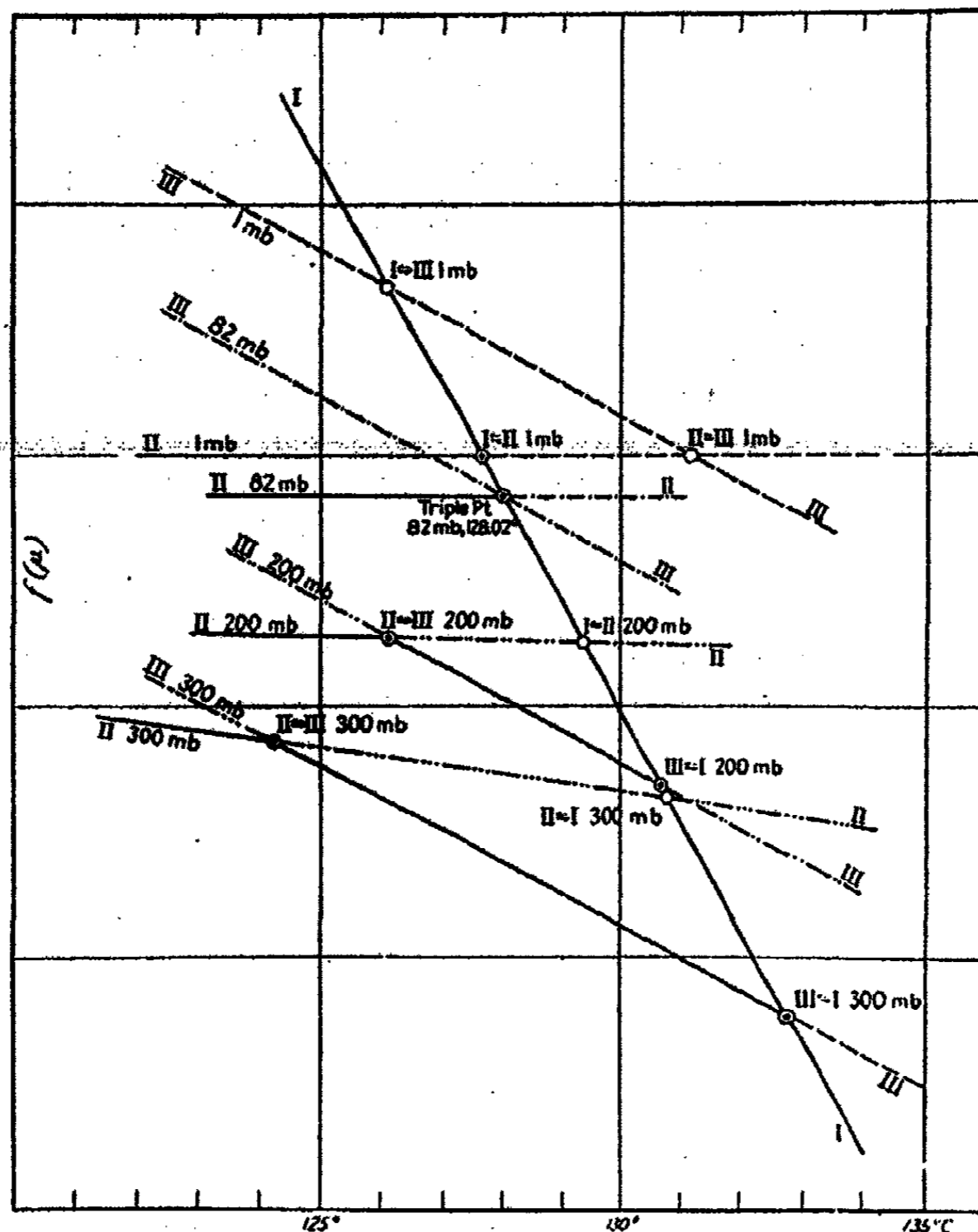

FIG. 10

Equilibrium diagram for the system  $KNO_3$ , at 1, 82, 200 and 300 mb pressure. Partly schematic. Phase I taken as the reference phase. Angles between the lines at each pressure are roughly proportional to heats of inversion. Metastable regions for phases II and III are indicated by broken lines. Number of dots in the broken lines differentiate phases at different pressures. Dotted circles mark stable inversions, open circles the metastable ones.

so that the tendency of the atoms to pass to positions of lower potential energy is held in check, and is overcome only when the potential energy difference becomes sufficiently large. There is no *a priori* reason to suppose that the distance of the hysteresis limits from the equilibrium point must be the same on motion in one direction as that for motion in the other; in general, they will not be exactly the same. When the hysteresis band is narrow the

distinction becomes relatively unimportant, but it does assume importance when the band is wide. Thus, dry  $\text{KNO}_3$  II inverts to  $\text{KNO}_3$  I at  $129.5 \pm 0.2^\circ$ , ca.  $1.9^\circ$  above the equilibrium temperature. Dry  $\text{KNO}_3$  I does not invert to  $\text{KNO}_3$  II directly, but does so indirectly only, through the medium of the metastable  $\text{KNO}_3$  III, and then only when it has fallen at least  $12^\circ$  below the equilibrium point.

It is easy to see that in dry samples of  $\text{KNO}_3$  heated above  $130^\circ$  and cooled rapidly there might persist a variable quantity of  $\text{KNO}_3$  III in addition to  $\text{KNO}_3$  II, at room temperature. The work of Cohen and Kooy (op. cit. pp. 308-18), on heats of solution of  $\text{KNO}_3$  previously subjected to various heat treatments, confirmed some anomalous results obtained by Roth (op. cit.) and makes it appear probable that samples of  $\text{KNO}_3$  cooled rapidly after heating above the inversion temperature may not be physically pure  $\text{KNO}_3$  II. Cooling curves of thermal analysis in my work indicate that *blocks* of  $\text{KNO}_3$  usually invert quite completely to  $\text{KNO}_3$  II when the reaction  $\text{KNO}_3$  III  $\rightarrow$   $\text{KNO}_3$  II has been induced to start; *granular*  $\text{KNO}_3$  on the other hand shows (Fig. 2) by the character of the recovery curve that when there is loose contact between grains the conversion of  $\text{KNO}_3$  III  $\rightarrow$   $\text{KNO}_3$  II does not go to completion very promptly, and it is conceivable that  $\text{KNO}_3$  III might easily persist to room temperature in some grains. The results obtained with microscopic examination of slides of melted  $\text{KNO}_3$  may be cited (section 2) as further favoring this view. Some of these slides, over a month old, still show the presence of a large proportion of  $\text{KNO}_3$  III in intimate contact with  $\text{KNO}_3$  II.

In their work on the density of  $\text{KNO}_3$  at  $30.0^\circ$ , Cohen and Bredée (op. cit.) point out the difficulty of preparing samples of thoroughly dry  $\text{KNO}_3$  which would give reproducible densities. The difficulty here is twofold. If the crystals contain inclusions of mother liquor, their densities will be invariably low. In this case it is not probable that  $\text{KNO}_3$  III will be present in any detectable quantity, because of the accelerating influence of moisture on the inversion. If the crystals are very dry they may contain some  $\text{KNO}_3$  III, but in this case the densities will be high rather than low.

23. *The Equilibrium Diagram.* To facilitate a ready visualization of the stability relations of the various solid phases of  $\text{KNO}_3$  at different pressures, a partly schematic equilibrium diagram is given in Fig. 10 for the pressures 1, 82, 200 and 300 mb by means of an arbitrary linear relation between the thermodynamic potential  $\mu$  and temperature  $t$ .  $\text{KNO}_3$  I was chosen as the reference phase. The lines for the other two phases,  $\text{KNO}_3$  II and  $\text{KNO}_3$  III are so placed that the angles between the lines are roughly proportional to the heats of inversion. Phase I is represented by a full line; II and III are drawn full when stable, and broken when metastable. The various pressures are distinguished by the number of dots in the broken lines. The intersections are at the equilibrium inversion temperatures, the dotted circles representing stable inversions, the open ones metastable inversions.

The principal aim in presenting this diagram is to illustrate the progression of the  $\mu$  line for  $\text{KNO}_3$  III from the metastable to the stable region as pressure

increases. Below 82 mb  $\text{KNO}_3$  III is wholly metastable; at 82 mb its stability region is represented by a point, the invariant triple point at which all three solid phases of  $\text{KNO}_3$  coexist at  $128.02^\circ$ ; above 82 mb its stability range lies between those of  $\text{KNO}_3$  II and  $\text{KNO}_3$  I over an increasing temperature interval as pressure increases. The reader can readily visualize the hysteresis bands by imagining vertical lines drawn on either side of the inversion points, between two coexistent phases, at the hysteresis limits.

#### Summary

$\text{KNO}_3$  exists at  $128.02^\circ$  C and 82 mb pressure in three varieties,  $\text{KNO}_3$  I,  $\text{KNO}_3$  II and  $\text{KNO}_3$  III.

$\text{KNO}_3$  I and  $\text{KNO}_3$  II are in equilibrium at  $127.6^\circ$  C and 1 mb pressure. The reaction proceeds reversibly in the presence of small amounts of water. In thoroughly dry salt  $\text{KNO}_3$  III appears metastably at 1 mb pressure, and is in metastable equilibrium with  $\text{KNO}_3$  I at  $126.1^\circ$  C. On heating,  $\text{KNO}_3$  II inverts directly to  $\text{KNO}_3$  I; on cooling, dry  $\text{KNO}_3$  I first changes metastably to  $\text{KNO}_3$  III which then inverts to  $\text{KNO}_3$  II. The last reaction is truly monotropic.

Above 82 mb pressure  $\text{KNO}_3$  III has a region of stability between definite temperature limits. The pressure-temperature diagram has been determined to 300 mb pressure with moist  $\text{KNO}_3$ .

Dilatometric measurements on the inversions show that the specific volume of  $\text{KNO}_3$  I exceeds that of  $\text{KNO}_3$  II at 50 mb by  $0.00484$   $\text{cm}^3/\text{g}$ . The volume changes of  $\text{KNO}_3$  II  $\rightarrow$   $\text{KNO}_3$  III and  $\text{KNO}_3$  III  $\rightarrow$   $\text{KNO}_3$  I have been measured at 151 and 251 mb. The values obtained are  $-0.0087$  and  $-0.0091$   $\text{cm}^3/\text{g}$  for II  $\rightarrow$  III and  $0.0134$  and  $0.0133$   $\text{cm}^3/\text{g}$  for III  $\rightarrow$  I, respectively, at the corresponding equilibrium temperatures.

Heats of inversion measured by the indirect method of radiation calorimetry are found to be 10.49 cal/g for II  $\rightarrow$  I, 5.52 cal/g for III  $\rightarrow$  I and  $-4.97$  cal/g for the II  $\leftarrow$  III inversion at atmospheric pressure.

The hysteresis limits are given and the conditions for metastability of  $\text{KNO}_3$  III at atmospheric pressure are discussed in detail.

*Geophysical Laboratory,  
Carnegie Institution of Washington,  
July, 1929.*

## THE INFLUENCE OF THE PROXIMITY OF A SOLID WALL ON THE CONSISTENCY OF VISCOUS AND PLASTIC MATERIALS\*

BY R. K. SCHOFIELD AND G. W. SCOTT BLAIR

### Introduction

In attempting to derive an expression for the rate of flow of a viscous or plastic material through a straight narrow tube of uniform cross-section under a pressure gradient, it is usually assumed:

- (1) that each particle of the material moves with constant velocity in a straight line parallel to the axis.
- (2) that there is no slip at the wall of the tube.
- (3) that the velocity gradient at any point depends only on the shearing stress at that point.

Using these assumptions, it is shown below that, no matter how complex the relationship between velocity gradient and shearing stress (so long as the former is fixed when the latter is fixed), the volume extruded in unit time will depend, for a given stress at the wall of the tube, upon the cube of the radius. While this is true for fluids, and is also true or nearly true for thick pastes of soil and other minerals, it is found not to be generally true of such pastes when examined over an extended range of concentration. Discrepancies would occur if condition (1) were invalidated owing to turbulence; but reasons are given for considering it unlikely that turbulence is responsible for the effect. It is found that the mean velocity, instead of being proportional to the radius, is divisible into two parts, one proportional to it and the other independent of it. The second term apparently represents a velocity imparted to the bulk of the material by an excessive velocity gradient near the wall of the tube, suggesting that the proximity of a solid wall influences the consistency of these materials and causes a breakdown of condition (3). On subtracting the second term, the contribution made to the mean velocity by the flowing of the bulk of the material is presumably left, from which consistency constants relating to the material in bulk can be obtained independent of the dimensions of the tube.

### Theoretical.

If condition (1) of the introduction be granted, so that the particles are not accelerated, the stress,  $W$ , at the wall of a tube of length  $L$  and radius  $R$  to which a pressure difference  $P$  is applied is  $PR/2L$ ; while the stress,  $S$ , at a point  $T$  within the tube and distant  $r$  from the axis is  $Pr/2L$ . Consequently  $r$  can be expressed in terms of  $S$  thus:

$$r = R/W \cdot S. \quad (1)$$

\* Soil Physics Department, Rothamsted Experimental Station, Harpenden, England

If  $v$  be the velocity at  $T$ , we may write in accordance with condition (3)

$$dv/dr = -f(S).$$

Substituting the value of  $r$  given by equation (i), and integrating

$$v = R/W \int_0^W f(S) dS, \quad (ii)$$

if, in accordance with (2)  $v = 0$  when  $S = W$ . The flow  $dV$ , between  $r$  and  $r + dr = 2\pi dr.v$ . Substituting for  $r$  and  $v$  from equations (i) and (ii) and integrating,

$$\frac{V}{\pi R^3} = \frac{2}{W^3} \int_0^W S \int_0^W f(S) dS.dS \quad (iii)$$

From this it is clear that, for any given material,  $V/\pi R^3$  should depend only on  $W$  if the three conditions are fulfilled.

By making specific assumptions about the form of  $f(S)$ ,  $V/\pi R^3$  can be evaluated. Thus using the Maxwell assumption that

$$f(S) = \mu S$$

where  $\mu$  (the fluidity) is the reciprocal of the viscosity, equation (iii) reduces to Poiseuille's equation in the form

$$\frac{V}{\pi R^3} = \frac{1}{4} \mu W.$$

In the same way the expression based on the Bingham<sup>1</sup> assumption can be deduced. Here it is supposed that the material does not flow unless a stress exceeding a critical value,  $S_0$ , be applied to it and that, at stresses higher than  $S_0$ , the velocity gradient equals  $\mu(S - S_0)$ . Again  $\mu$  is a constant having the dimensions of a reciprocal viscosity, and is usually called the mobility. When such a material is forced through a tube, a central cylinder of radius  $RS_0/W$ , within which the stress is less than  $S_0$ , moves as a solid plug, and only the material outside this cylinder flows. When  $W$  is less than  $S_0$ , no flow occurs, and  $V = 0$ . In substituting in equation (iii) to obtain the value of  $V$  when  $W$  exceeds  $S_0$ , it must be remembered that, since  $f(S)$  is discontinuous, being zero from 0 to  $S_0$  and  $\mu(S - S_0)$  from  $S_0$  to  $W$ , the integrations must be carried out in two stages. This has the effect of splitting  $V$  into two terms, thus

$$\frac{V}{\pi R^3} = \frac{2}{W^3} \int_0^{S_0} S \int_{S_0}^W \mu(S - S_0) dS.dS + \frac{2}{W^3} \int_{S_0}^W S \int_{S_0}^W \mu(S - S_0) dS.dS.$$

The first is the contribution of the plug, the second is that of the flowing material between it and the wall. This reduces to

$$\frac{V}{\pi R^3} = \frac{1}{4} \mu \left[ W - \frac{4}{3} S_0 \left\{ 1 - \frac{1}{4} \left( \frac{S_0}{W} \right)^2 \right\} \right]$$

which is subject to the condition that  $W > S_0$ . This is equivalent to the

<sup>1</sup> E. C. Bingham: "Fluidity and Plasticity," (1922).

equation<sup>1</sup> deduced by Buckingham,<sup>2</sup> and independently by Reiner.<sup>3</sup> The graph connecting  $V/\pi R^3$  and  $W$  corresponding to this equation is tangential to the  $W$  axis at  $W = S_0$ . It is strongly curved for values of  $W$  only slightly exceeding  $S_0$ , but at higher values approximates to a straight line of equation

$$\frac{V}{\pi R^3} = \frac{1}{4} \mu \left( W - \frac{4}{3} S_0 \right).$$

This line makes an intercept on the  $W$  axis equal to  $4/3 \cdot S_0$ , and, like the corresponding graph of the Poiseuille equation, has a slope of  $1/4 \cdot \mu$ . The true curve is steeply asymptotic to the limiting straight line, the discrepancy in  $V$  being less than 1% when  $W$  exceeds 2.2 times the intercept of the limiting straight line.

If the parabolic relation

$$f(S) = \bar{\mu} S^n$$

of the Ostwald type<sup>4</sup> be assumed, equation (iii) reduces to

$$\frac{V}{\pi R^3} = \frac{1}{n+3} \bar{\mu} \cdot W^n$$

which is equivalent to the equations given by Farrow, Lowe and Neale,<sup>5</sup> and Porter and Rao.<sup>6</sup> The constant  $\bar{\mu}$  has dimensions which depend on the exponent  $n$ . The graph in this case starts from the origin, and is curved throughout its length. The curvature is never very strong, but it decreases only slowly with increasing  $W$ .

#### Experiments.

The modified Bingham plastometer used in this work has already been described.<sup>7</sup> The paste to be investigated is made by mixing the soil, clay or other mineral with water into a smooth paste, which is then forced through a one hundred mesh-per-inch sieve to remove any coarse particles. The paste is then diluted to the required concentration, and sucked into the plastometer bulbs which, for the high-stress work here described, have a capacity of 100 c.c. each. The material is forced alternately from one bulb into the other through one of a series of standardised tubes, the level in the bulbs being kept approximately the same by tilting the whole system about a pivot. For this more accurate work with larger bulbs it becomes necessary to correct the pressures for the resistance offered by the bulbs themselves. For this purpose the bulbs are connected directly with one another, and the pressures corresponding to a series of volume-flows are measured. By graphi-

<sup>1</sup> Buckingham's equation contains an additional term which is negligibly small when  $W$  exceeds  $S_0$ , and which is referred to below.

<sup>2</sup> E. Buckingham: *J. Am. Chem. Soc.*, **Test. Mat.**, 1921, 1154.

<sup>3</sup> Reiner: *Kolloid-Z.*, 39, 80 (1926), etc.

<sup>4</sup> Wo. Ostwald (and others): *Kolloid-Z.*, 36, 99, 157, 248 (*Zsigmondy Festschrift*) 252 (1928); 38, 261 (1926); 41, 56, 112 (1927). (This type of equation was, of course, not originated by Ostwald, but he has made much use of it.)

<sup>5</sup> Farrow, Lowe and Neale: *J. Textile Inst.*, 19, T 18 (1926).

<sup>6</sup> Porter and Rao: *Trans. Faraday Soc.*, 23, 311 (1927).

<sup>7</sup> G. W. Scott Blair and E. M. Crowther: *J. Phys. Chem.*, 33, 321 (1929).

cal intrapolation the correction,  $P_b$ , corresponding to each volume-flow can be estimated. As no appreciable increase in resistance is caused by introducing a few millimeters of narrow tubing between the bulbs, it may safely be concluded that no kinetic energy correction is necessary with these measurements. The tubes had been carefully selected with a view to uniformity of bore and were standardised by weighing the quantity of mercury required to fill them. A series of constant pressures are applied by means of compressed air, the pressure being measured on a water or mercury manometer according to its magnitude. The air displaced by the clay is allowed to escape through an air-capillary of suitable dimensions. The pressure difference (negligible in comparison with the applied pressure) is measured on an alcohol manometer at an angle of one in ten (the flow-meter), and is directly proportional to the volume of flow of paste per second. The moisture content of the paste is determined by heating a sample for one hour in an oven at a temperature of  $160^{\circ}\text{C}$ . The concentration,  $K$ , is expressed as the number of grams of dry matter per 100g paste. Volume concentrations are calculated on the basis of a constant specific gravity for the dry material of 2.7.

In carrying out this work efforts have been made to use as wide a range of radii as possible. Although it is hoped in the future to increase this still further, difficulties will first have to be overcome. Thus the use of very wide capillaries involves large volumes of material and consequently big bulb correction (always difficult to determine accurately). Moreover the increased length that must be given to the tube necessarily entails a sacrifice of uniformity in the bore. Thus beyond certain limits, the loss in accuracy renders further increase in radius of no advantage. With very narrow tubes so coarse a system as a soil-paste behaves erratically.

In Table I are given, as an example, the complete data for a sample of Broadbalk Field subsoil similar to that of which the clay-fraction has been used in the previous work.

TABLE I

Plastometric data for Broadbalk subsoil paste (33.5 g dry soil per 100 g paste).

Cap. II.  $R = 0.093$  cm.  $L = 12.20$  cm.

P	a	V	$P_b$	S	v.
8.0	3.0	2.0	1.1	3.5	.75
9.0	4.2	2.7	1.3	3.9	1.05
10.0	4.4	3.0	1.4	4.4	1.10
11.0	5.2	3.5	1.5	4.9	1.30
12.0	5.7	3.7	1.5	5.4	1.42
13.0	6.7	4.6	1.8	5.7	1.68
14.0	7.0	4.8	1.8	6.2	1.75
15.0	8.2	5.4	1.9	6.7	2.05

Cap. III. R = 0.073 cm. L = 12.10 cm.

P	a	V	Pb	S	v.
14.0	2.8	1.9	1.0	5.2	1.13
16.0	3.7	2.5	1.3	5.9	1.49
20.0	4.2	2.9	1.4	7.4	1.73
22.0	5.1	3.5	1.4	8.2	2.08
24.0	5.7	3.9	1.5	9.0	2.32
26.0	6.1	4.2	1.6	9.7	2.50
28.0	6.8	4.6	1.8	10.4	2.74
30.0	7.3	5.0	1.8	11.2	2.97

Cap. 7 R = 0.059 cm L = 10.60 cm

P	a	V	Pb	S	v.
15.0	1.5	1.0	0.7	5.3	0.93
20.0	2.4	1.6	1.0	7.1	1.48
25.0	3.2	2.0	1.1	8.9	1.98
30.0	4.0	2.6	1.3	11.1	2.50
35.0	4.8	3.1	1.4	12.5	3.00

Cap. IV. R = 0.048 cm. L = 12.25 cm.

P	a	V	Pb	S	v.
16.0	0.5	.34	0.6	3.9	.47
24.0	1.05	.72	0.7	6.0	.99
28.0	1.3	.88	0.7	7.0	1.22
32.0	1.6	1.09	0.8	8.0	1.50
38.0	1.95	1.33	0.8	9.5	1.85
40.0	2.0	1.36	0.8	10.0	1.88
42.0	2.1	1.43	0.8	10.5	1.98
44.0	2.25	1.53	1.0	11.0	2.12

Cap. V. R = 0.040 L = 12.30 cm.

P	a*	V	Pb	S	v.
20.0	0.3	.06	0.6	4.2	.40
25.0	0.5	.10	0.6	5.3	.66
30.0	0.7	.13	0.6	6.4	.93
35.0	0.85	.16	0.6	7.4	1.13
40.0	1.05	.20	0.6	8.5	1.35
45.0	1.2	.23	0.6	9.6	1.60

*Bulbs alone without capillary.*

(A water manometer was used, but P is given converted into cm. Mercury).

P	0.5	1.0	1.5	2.0
a	*0.2	0	2.0	6.0
V	0.4	0	1.4	4.1

\* (V/a = .19).

P is pressure in cm. mercury.

a is flowmeter reading (V/a = 0.68).

V is volume flow in cm<sup>3</sup>/secs.

Pb is pressure due to bulbs in cm. mercury.

S is stress in dynes/mm.<sup>2</sup> (calculated from P - Pb).

v is mean velocity in metre/secs.



It is well known that the data obtained with such an apparatus when plotted on a  $V/\pi R^3 - W$  basis fall into two groups. In one, which may conveniently be called type A the points for a single tube lie, within the limits of experimental error, on a straight line passing through the origin. In the other

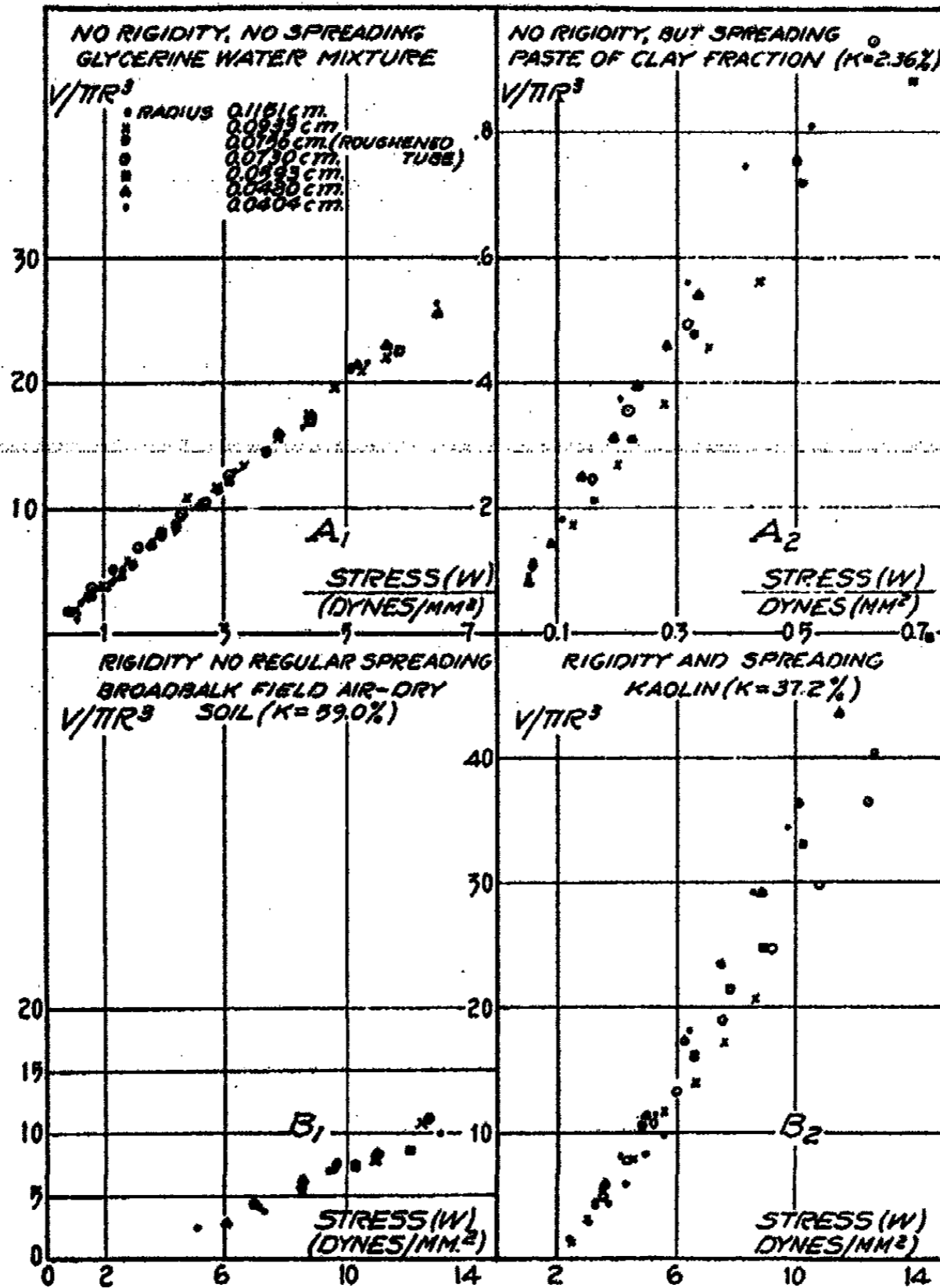

FIG. 1  
Legends incorporated in four corners of each quarter of drawing.

(type B) this is not the case. Our own measurements not only confirm this fact but show that each group must be further subdivided according as the curve obtained is or is not independent of R. There are thus four possibilities, an instance of each which is given in Fig. 1.

With the water-glycerine mixture (type A<sub>1</sub>) a single straight line through the origin gives an adequate representation throughout the range of stress used. This is not true of the dilute suspension of very fine soil particles.

(type A<sub>2</sub>) Here the best line though passing through the origin has a larger slope the smaller the radius. Thus the disconcerting fact is here revealed that a straight line through the origin obtained with a single tube is not by itself a proof that Poiseuille's law is being obeyed.

The thick paste of Broadbalk Field surface soil gives points which, though more erratic than those for water-glycerine, show no regular trend with change of radius. Nevertheless they cannot be represented as falling on a straight line through the origin (type B<sub>1</sub>). The behaviour of *thick* soil pastes has already been described in detail in the earlier paper,<sup>1</sup> where it is shown that the curves can be interpreted in the light of the Bingham postulate. New and more accurate measurements over a wider concentration range has shown that a slight spreading noticeable in some of the earlier data and attributed to experimental error cannot be so explained. In thinner pastes of soils, clays and simple minerals such as barytes and gypsum the spreading is very marked. A kaolin paste of moderate consistency is given as an example (type B<sub>2</sub>). Here as with type A<sub>2</sub>  $V/\pi R^2$  for a given value of  $W$  increases as  $R$  decreases.

An alternative way is to regard type B<sub>2</sub> as the general case: the other three being special and simpler cases. Such a view raises the question as to whether all these systems are susceptible to the same treatment, and can therefore be represented by a single though complex, equation. Already in the interpretation of curves of the B<sub>1</sub> type, two distinct schools of thought have developed, one of which bases its treatment on Bingham's postulate and the other on the Ostwald postulate. This is not the place to enter into a general discussion of the relative advantages of the two methods, suffice it to say that all the soil and mineral pastes investigated in this laboratory are more amenable to the first method; and that although there undoubtedly are systems such as benzene-rubber and pastes of at least some starches that give curves of a shape not accounted for by the simple Bingham postulate, it is nevertheless true that much of the data which is represented as conforming to a relationship of the Ostwald type can as well be cited in support of the simple linear relationship. (Vide Herschel and Bulkley,<sup>2</sup> Porst and Moskowitz,<sup>3</sup> Scott Blair,<sup>4</sup> Ostwald<sup>5</sup>).

Hatschek<sup>6</sup> has criticised the practice of extrapolating flow-curves by means of straight lines, and considers that, failing a discontinuous change from a curved to a straight portion, the choice of the portion to be regarded as straight is arbitrary and a matter of scale. According to the Bingham treatment these straight lines are asymptotes to which the true flow-curve approximates more and more closely as the stress increases. It is clear in general that the error involved in drawing an asymptote to an experimental curve depends on the

<sup>1</sup> G. W. Scott Blair and E. M. Crowther: *J. Phys. Chem.*, 33, 321 (1929).

<sup>2</sup> Herschel and Bulkley: *Ind. Eng. Chem.*, 16, 927 (1924) etc.; *Proc. Am. Soc. Test. Mat.*, 26, 621 (1926).

<sup>3</sup> Porst and Moskowitz: *J. Ind. Eng. Chem.*, 14, 49 (1922).

<sup>4</sup> Scott Blair: *Kolloid-Z.*, 47, 76 (1929).

<sup>5</sup> Ostwald: *Kolloid-Z.*, 47, 176 (1929).

<sup>6</sup> Hatschek: "The Viscosity of Liquids," 209 (1928).

steepness of approach. It would certainly be difficult to draw the asymptote to a rectangular hyperbola given only a portion of the curve; but the criticism loses its force where the curve is of the Buckingham-Reiner type. In this case, already noted, the discrepancy in  $V$  is less than 1% for values of  $W$  greater than 2.2 times the intercept. Above this limit the difference between the true curve and the limiting straight line should be outside the limits of experimental error. This is borne out in practice with soil and clay pastes, so that linear extrapolation appears justified with these materials.

#### *Discussion.*

These experiments yield the result that for many viscous suspensions (type A) as well as plastic pastes (type B),  $V/\pi R^3$  does not depend only on  $W$ . As the variation of the former quantity sometimes approaches twofold for a twofold variation of radius, the effect is evidently quite outside the limits of ordinary experimental error. Moreover the fact that the apparatus gives a very satisfactory verification of Poiseuille's law for true fluids indicates that it works satisfactorily. The effect has every appearance of being genuine. The next step therefore is to seek its cause. This must lie in a breakdown of one or more of the three conditions set out in the introduction. These will be considered in turn.

A breakdown of the condition that the particles move with a constant velocity parallel to the axis would occur if the flow were turbulent. Although no complete theory of turbulent flow has yet been advanced, it is generally considered that its presence is marked by a falling off in the slope of the flow-curve as the stress is increased. Such a falling off does occur at very high stresses, particularly with the more dilute suspensions; but the curves obtained with a view to elucidating the effect under discussion were not followed far enough for this to happen, and as can be seen from the examples given, show no signs of curvature over the range examined. It might be urged that the close approximation to linearity arises from a chance cancellation of opposite curvations, in a manner similar to that suggested to explain the "Laminarast" or linear portion of the flow-curves obtained by Ostwald and Auerbach.<sup>1</sup> As against this, it should be pointed out that many hundreds of flow-curves for clay and soil pastes have now been accumulated in this laboratory, and not one reliable curve has been obtained which cannot be fairly represented by a straight line at sufficiently high stresses. It seems inconceivable that an exact cancellation of two unconnected tendencies should occur in all these cases. It is more reasonable to interpret the straightness as an indication that these materials are obeying both condition (1) and the Bingham postulate and to endeavour to deduce an equation of the Buckingham-Reiner type based on a modification of conditions (2) and (3).

Until the results to be expected when flow is turbulent have been more fully worked out, it is impossible to exclude it altogether from the possible causes contributing to the effect. All that can be said at present is that there

<sup>1</sup> Ostwald and Auerbach: *Kolloid-Z.*, 38, 261 (1926); 41, 56 (1927).

is no positive evidence that turbulence is present in these experiments. This statement applies with equal force to the 'structure' type of turbulence postulated by Ostwald as to the more general type.

On plotting the mean velocity  $V/\pi R^2$  rather than  $V/\pi R^3$  against  $W$ , a regularity becomes apparent. A typical set of curves plotted in this way

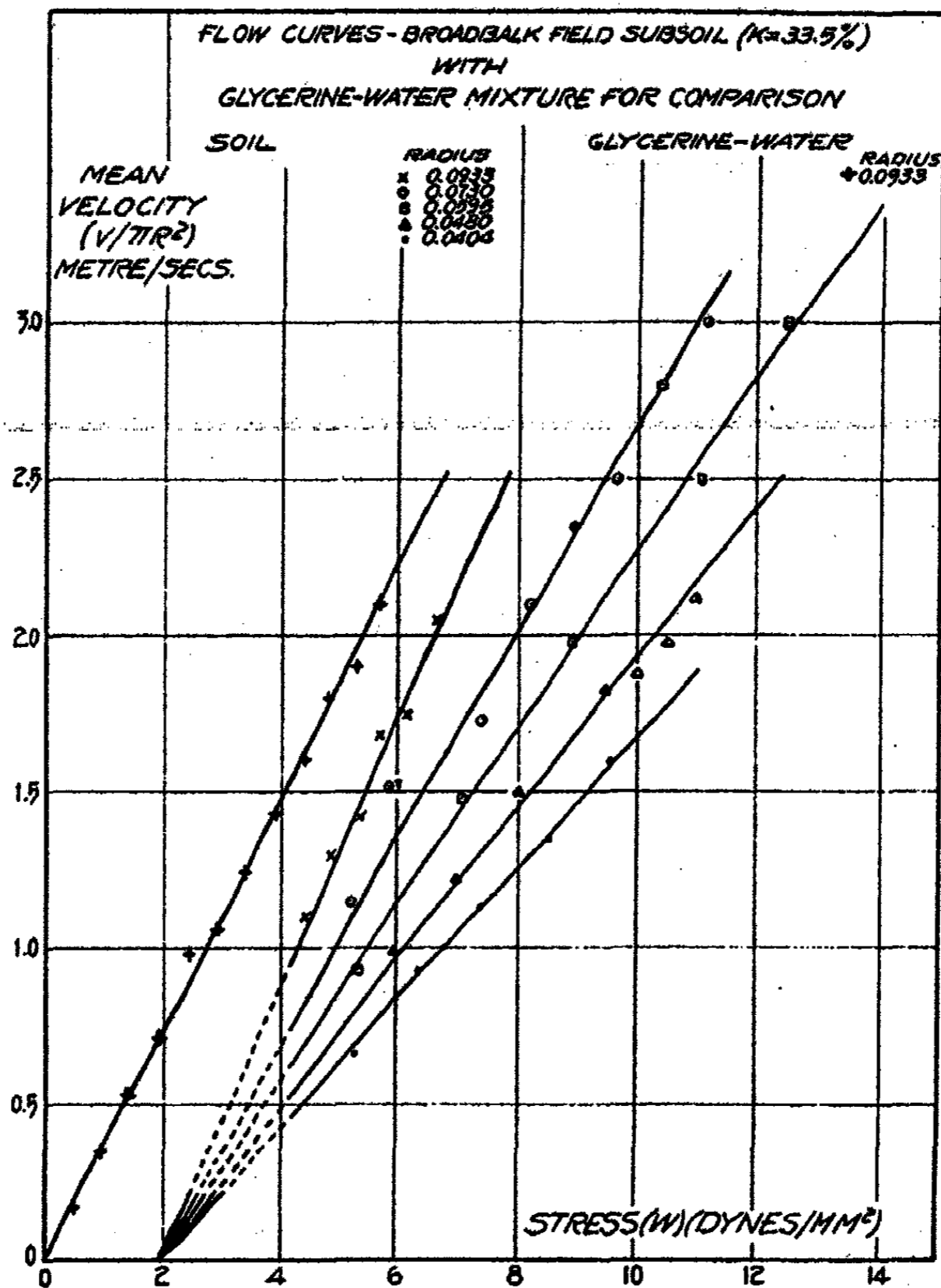

FIG. 2

from the data in the table is shown in Fig. 2. Since according to the Buckingham-Reiner equation (see above) the points should lie above the limiting straight line by more than 1% at values of  $W$  less than 2.2 times the intercept these have been omitted, and only those for stresses above 4.4 dynes/mm<sup>2</sup> have been used for locating the limiting straight lines. As these have a common intercept their slopes would be proportional to  $R$  were  $V/\pi R^2$  dependent only on  $W$ . Actually when the slopes  $\sigma$  are plotted against  $R$  a

straight line can in all cases be drawn through the points, but for types A<sub>2</sub> and B<sub>2</sub> this does not, when extrapolated, pass through the origin, but gives a positive intercept on the slope axis. Curves connecting  $\sigma$  and R which may conveniently be spoken of as derived curves are given in Fig. 3 for the four sets of curves of Fig. 1. The derived curve obtained from Fig. 2 together with ones for pastes of barytes and gypsum are given in Fig. 4. If turbulence

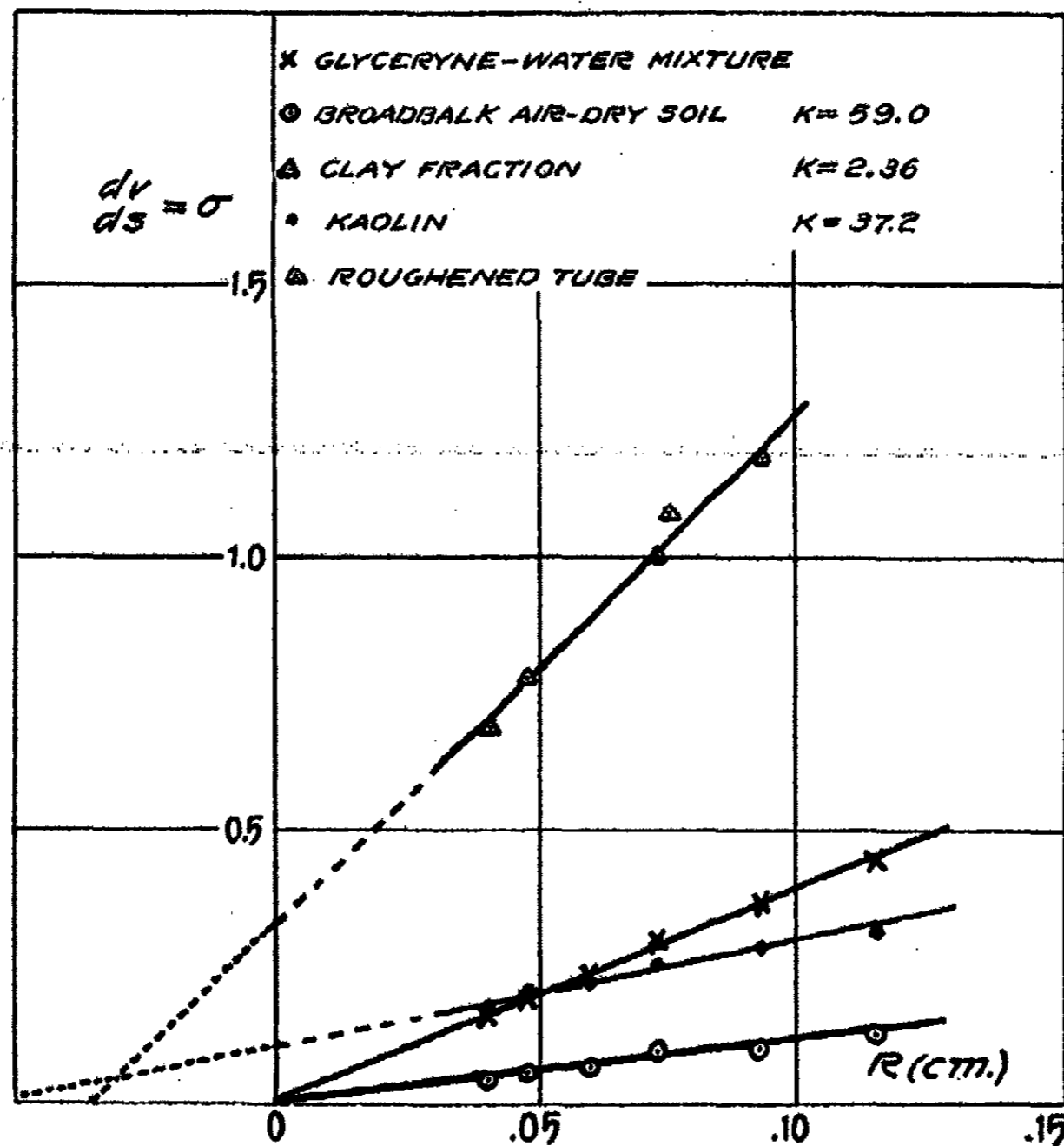

FIG. 3  
Derived curves

were the sole cause of the effect, the disturbance would presumably be most marked in the widest tube. In these conditions the mean velocity for a given stress on the wall should be more nearly proportional to the radius with the smaller tubes than with the wider ones. In other words the derived curve should approximate more closely to a straight line through the origin the smaller the radius. It will be seen that the curves in Figs. 3 and 4 taken as a whole do not support this idea.

If, on the other hand, the derived curves are in reality straight lines (as shown), the fact that some give an intercept might be interpreted as indicating that conditions (1) and (3) are fulfilled, but that in such cases there is a slip at the wall. The slope  $\sigma$ , and hence the mean velocity at a given value of  $W$  can in these cases be separated into two components, one proportional to

the radius and one independent of it. It seems more probable however that the second component instead of representing an actual slip at the wall should be regarded as a velocity imparted to the bulk of the material by excessive flowing of the material in the immediate vicinity of the wall. Provided that the thickness of the region in which this excessive flow takes place is both independent of the radius and also small in comparison with it, the effect on

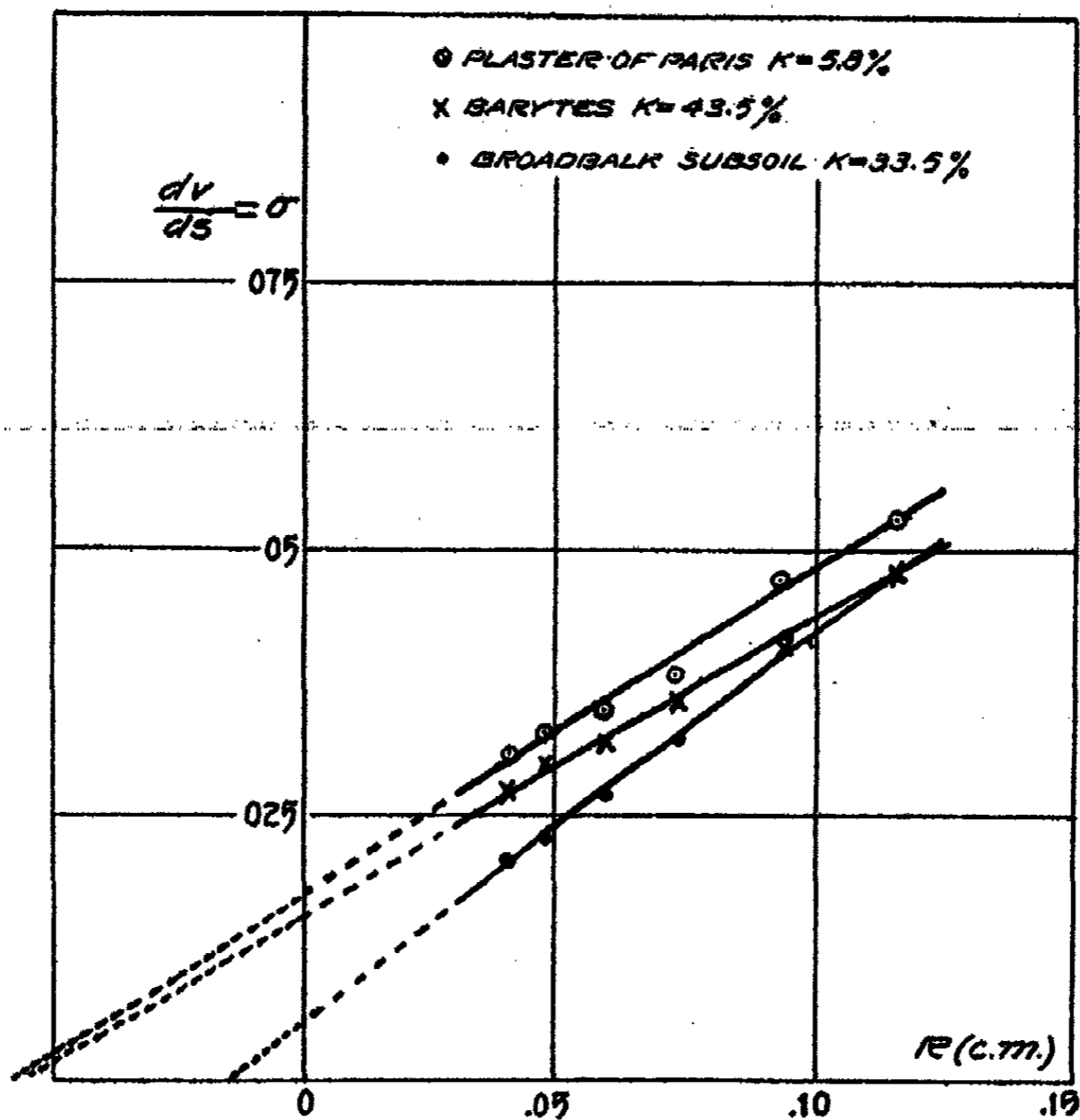

FIG. 4  
Derived Curves

the mean velocity would be the same as that of a slip at the wall itself. There would however be a difference in tubes so narrow that the radius is of the same order of magnitude as the thickness of the region of excessive flow, as in this case the derived curve would bend round towards the origin.

The first component of the mean velocity, since it is proportional to  $R$  is presumably due to the flow of the material in bulk, and therefore equal to  $V/\pi R^2$  calculated from equation (iii) using the appropriate value for  $f(S)$ . In cases where the Bingham postulate is applicable to the material in bulk the first component will be that given by the Buckingham-Reiner equation and the slope of the derived curve will equal  $\frac{1}{2}\mu$ . The second component of mean velocity is equal, according to the constructions in Figs. 2 and 3, to  $\sigma_0 (W-C)$  when  $\sigma_0$  is the intercept of the derived curve on the  $\sigma$  axis and  $C$

the common intercept of the flow curves (Fig. 2) on the  $W$  axis (which according to the Buckingham-Reiner equation should equal  $4/3 S_0$ )

The existence of a very thin layer of fluid of the consistency of water, separating the paste from the wall has been assumed by Buckingham to account for the small movement which occurs at stresses so low that the bulk of the material does not flow. This view, slightly modified, was adopted in the earlier paper, where it was shown experimentally that this flow is related to the stress thus:

$$V/\pi R^2 = v = \epsilon\phi (W - A) \quad (\text{vii})$$

$A$  being a constant stress below which no movement occurs,  $\epsilon$  the thickness of the layer and  $\phi$  its mobility. It might at first appear that the second component of the velocity is the same as the above. This, however, can hardly be the case since  $\sigma_0$  is found to have a magnitude some 100 times that of  $\epsilon\phi$ . For this reason the second component, unlike the Buckingham term, cannot be neglected at high stresses when the material is flowing. Assuming a value of  $\phi$  equal to the fluidity of water in bulk, the thickness  $\epsilon$  is of the order  $10^{-6}$  cm. The corresponding thickness calculated from  $\sigma_0$  is of the order  $10^{-3}$  cm. As the mobility of the modified layer cannot be greater than that of water in bulk and is probably less, this latter is a minimum estimate.

Experiments with tubes, the walls of which had been etched with fluoride also reveal an essential difference between the two phenomena. It was found (*loc. cit.*) that etching greatly interferes with the motion at very low stresses and renders equation (vii) inapplicable. No corresponding influence on  $\sigma_0$  is observed. Thus it will be seen from Figs. 1 and 3, that the points obtained with the etched tube fall into line with those for the smooth tubes. A further distinction is apparent in the behaviour of pastes made from soils that have previously been air-dried. Movement at low stress is inhibited whereas no similar interference is found at high stresses. It would appear therefore that, where the derived curve does not pass through the origin, there exists in the immediate neighbourhood of the wall of the tube a region in which the viscous or plastic properties of a material flowing through it are modified. When a laminated material such as a clay paste flows through a tube particles near the wall will tend to align themselves in the direction of flow, and be unable to rotate under the influence of the viscous couple acting in them. In the bulk of the material the particles will rotate sufficiently to prevent any alignment. If indeed there be any such an orientation near the wall it might give rise to an increase in mobility as the wall is approached and thus to a deviation from equation (iii) such as is actually observed. On the other hand attempts to eliminate the  $\sigma_0$  term by the use of materials which are believed to be devoid of laminar structure has so far proved unsuccessful. Only true fluids show both no  $\sigma_0$  term and no rigidity. An alternative explanation would involve an increased concentration of the suspended material towards the centre of the tube relative to the region near the wall, the relatively more dilute material having a greater mobility. In order to test this idea a sample of clay suspension giving a high value for  $\sigma_0$  was forced through a metal tube through

the side of which a hole had been drilled. This hole was very small so that the exuding of material through it would scarcely interfere with the flow in the tube. Although a large variation in concentration would have to be assumed to account for the value of  $\sigma_0$  observed, no appreciable difference in concentration was found between the exuded material and the rest.

We are not, therefore, in a position to offer a detailed physical explanation of the effect observed. Yet the view that the properties of the material are modified in the neighbourhood of the wall is supported by another fact which has been repeatedly observed, but which has hitherto received no explanation. It will be seen that in Fig. 2 of the previous paper (p. 326) the ratio of the extrapolated intercept on the pressure axis in the V-P curve, to the pressure at which flow at the wall just starts, is somewhat greater than the  $4/3$  necessitated by the Buckingham-Reiner equation. This discrepancy may well be due to a decreased value of  $S_0$  in the neighbourhood of the wall.

#### *The Determination of Consistency Constants.*

Methods for determining absolute consistency constants have hitherto been based on the supposition that, provided the motion is not turbulent,  $V/\pi R^3$  depends only on  $W$  and the nature and concentration of the material. Where this is not true (Types A<sub>2</sub> and B<sub>2</sub>) the methods require modification whether the constants are defined with reference to the curves obtained by plotting  $V/\pi R^3$  against  $W$  (Buckingham-Reiner equation) or by plotting the logarithms of these quantities (Farrow, Lowe and Neale equation). In such cases, it is impossible to define a viscous constant for the material from measurements made with a single capillary, since there would be a progressive change in its value with radius were the usual method adopted. An instance is given in Fig. 5 where the viscosity as given (1) by the Poiseuille-Bingham method for wide and narrow capillaries respectively and (2) from the slope of the derived curve is plotted against the concentration. The latter construction has the advantage of giving a single constant independent of radius, which, if the considerations advanced above are correct is a measure of the viscous properties of the bulk of the material.

Moreover, the shape of the viscosity-concentration curve as given by the second construction is such as would be expected if the deviation from linearity were due simply to a decrease in the extent of hydration of the particles. This shape is not reproduced in the curves derived from the single capillaries. The curve from the smallest capillary has an upward curvature of the type frequently obtained for concentration curves for hydrophylic materials with a simple Ostwald viscometer.

It is at least apparent that measurement of the viscosity of suspensions cannot be considered to be reliable unless made with at least two tubes of reasonably differing radii.

The method at present used in this laboratory for determining the consistency constants for soil and clay pastes is as follows:

The data for a series of four or five different capillaries having a total range of radius of at least two-fold are plotted out on a  $V/\pi R^3:PR/2L$  basis,



the values of P having previously been corrected for the resistance of the bulbs. The best straight lines are then drawn through the points in such a way that they converge on the stress axis. The point at which these extrapolations converge is taken as the rigidity, C.<sup>1</sup> The slope ( $\sigma$ ) of each curve is then measured (i.e. the rise in  $V/\pi R^2$  per unit increase in stress) and  $\sigma$

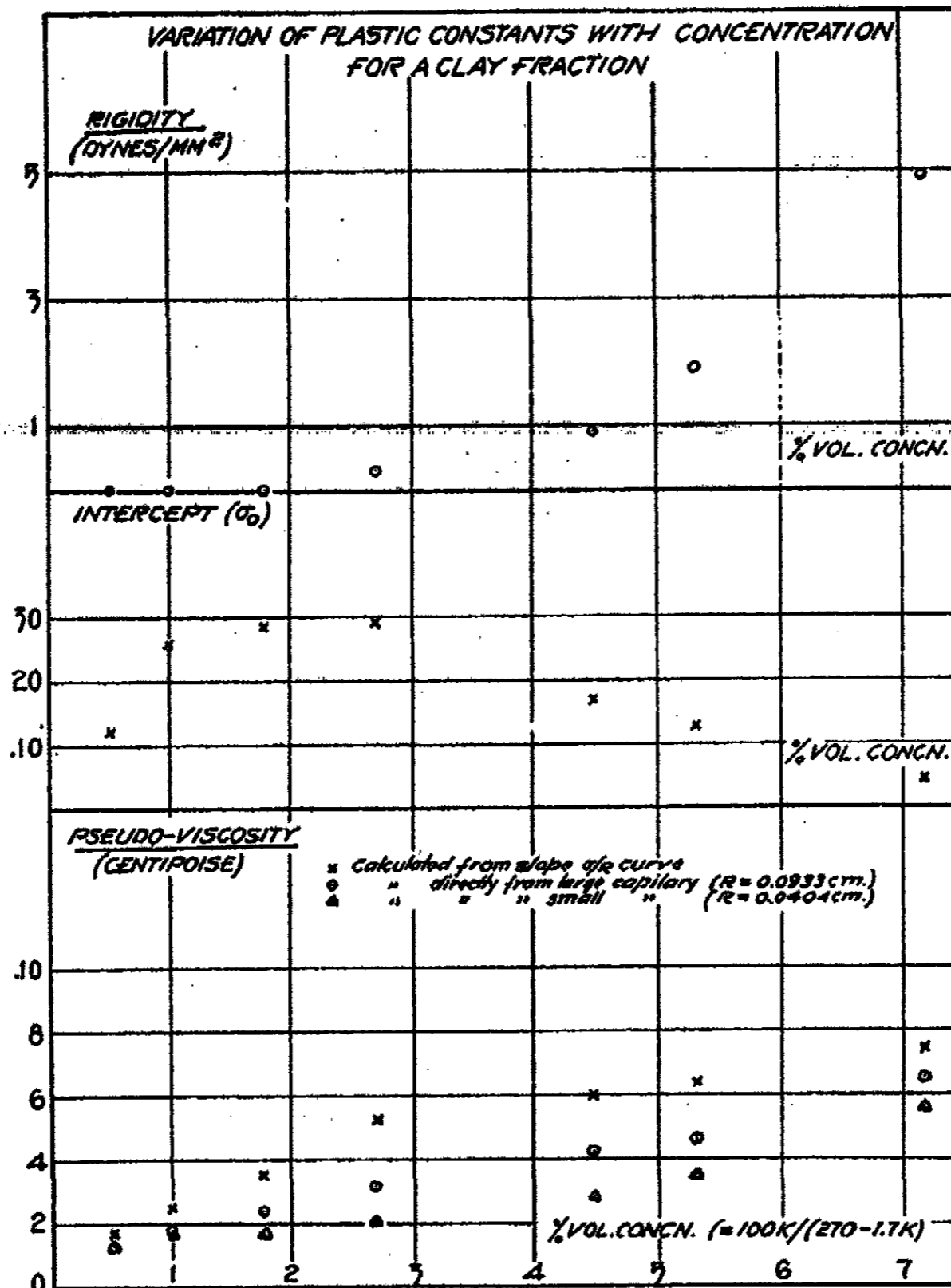

FIG. 5

is plotted separately against R. The slope of the derived curve ( $dR/d\sigma$ ) divided by 4 is taken as the viscous constant  $\eta'$  (pseudo-viscosity =  $1/\mu$ ) and the intercept of the extrapolated curve on the  $\sigma$  axis as  $\sigma_0$ , a measure of the wall effect.

Fig. 5 shows an interesting relationship for a clay fraction between  $\sigma_0$  and concentration, the value of  $\sigma_0$  passing through a maximum at a low

<sup>1</sup> This is, of course, the "limit of rigidity" i.e. Bingham's yield value, not the rigidity modulus.

concentration and disappearing for pure water and also at high concentrations where the high rigidity limits a further extension of the concentration range. Accurate measurements of  $\sigma_0$  at low concentrations are not easy, and the values are liable to a fairly large error, but there can be no doubt as to the general shape of the curve. It is of interest that the maximum of the curve occurs at about the same concentration as that at which rigidity first makes its appearance.

Since the dimensions of  $\sigma_0$  are somewhat inconvenient, an alternative method is to extrapolate the derived curves still further onto the negative radius axis. In this way a hyperthetical length ( $R_0$ ) is obtained which must be added to each radius before the equation stating the proportionality of the slope of the  $V/\pi R^2: PR/2L$  curves to (viscosity  $\times$  radius) can be applied. In other words  $R^2(R + R_0)$  takes the place of the  $R^4$  in the equations of Poiseuille or Buckingham-Reiner when written so as to give  $V$  directly in terms of  $P$ .

Our thanks are due to Dr. B. A. Keen for his interest and criticisms throughout the progress of this work.

#### Summary

If, in considering the flow of a plastic material through a narrow tube, it be assumed that the velocity gradient at any point depends only on the stress at that point, it necessarily follows that the mean velocity for a given stress at the wall of the tube should be directly proportional to the radius of the tube. Although thick soil pastes conform closely to this requirement, thinner pastes whether they show rigidity or not give marked discrepancies. These discrepancies can be accounted for by assuming that in the immediate proximity of the wall a modification of the plastic properties occurs, which imparts an additional velocity to the bulk of the material. By first subtracting this velocity a viscosity constant is obtained independent of the dimensions of the tube.

## SOAP FILMS AND COLLOIDAL BEHAVIOUR

BY A. S. C. LAWRENCE

Aqueous soap solutions, which have the peculiar property of forming stable films, bubbles and foams, are also the best known example of a rather unusual type of colloidal solution. In addition, many other colloids, such as the proteins, form stable films. For these reasons confusion exists between these two sets of properties although they actually have no closer connection than a common origin in the peculiarities of the soap molecule.

Much of this confusion has arisen through failure to differentiate between liquid soap films and films which are not truly liquid. The undoubted colloidal structure of these latter has led to the idea of a colloidal structure for soap films. As opposed to these, structures have been proposed which certainly err on the side of simplicity.<sup>1</sup> Bubbles can be blown from mercury and selenium but they are small, unstable, and in no way comparable with soap films.

The real problem of the soap film is that it exists at all. To consider, for simplicity, a plane film; why does the liquid composing it not fall freely under gravity? Or, alternately, why does the film not contract to a spherical drop under the influence of surface tension?

Now, as a matter of fact, gravity does exert some influence on the rate of thinning of a vertical film; but the fact that a horizontal film thins shows that this process is largely independent of gravity.

To explain the existence of the soap film, it has been suggested that it has a sandwich structure; that its stability depends upon the presence of a surface layer at each face between which is included a variable amount of liquid.<sup>2</sup> Thinning will be regulated by the laws of fluid viscosity; that is, according to Poiseuille's law, the rate will be proportional to the fourth power of the distance between the two surface layers. It is clear that in very thin films this viscous resistance will be very large. This structure also explains why there are no effects due to gravity in a horizontal film.

It has been suggested that these surface layers possess colloidal properties;<sup>3</sup> it has also been suggested that the interior liquid has a colloidal structure.<sup>4</sup> I shall show that the characteristic properties of the liquid soap film require neither of these proposals.

### Adsorption in Soap Films

This sandwich structure was suggested for the soap film many years ago but it is only recently that accurate information has accumulated concerning the surface layers required. Of course this surface layer does not only exist at the surface of the soap film but also at the surface of any soap solution. But, whereas in a soap solution there is one surface layer covering a very large depth of liquid, in the soap film there are two surface layers enclosing a very small amount of interior liquid.

The first experimental evidence of the existence of this surface layer on soap solutions was provided by some observations made by Lord Rayleigh many years ago.<sup>2</sup> It had long been known that soap solutions were characterised by very small surface tension—about one third that of water—when measured by the usual methods. He compared these values of the “static” surface tension with those obtained by a “dynamic” method in which the surface whose tension was being measured was continuously renewed during the measurement. He found that the dynamic values were considerable larger than the static ones, the difference being most marked in the more dilute solutions; thus indicating that the lowering of the surface tension of water by soap is due to the formation of a specific surface layer which takes a definite though small time to form. Confirmation of this view is provided by the recent work of du Noüy on the static surface tension of soap solutions at enormous dilutions. He found that a millionth part of soap does not affect the surface tension of water at all initially but that on standing quite undisturbed for two hours a drop of 20 dynes ensues.<sup>3</sup>

The application of the Gibbs adsorption equation to soap solutions is a matter of extreme complexity. The surface tension concentration curves of the soaps fall very steeply until a minimum of about one third of the surface tension of water is reached at a concentration of about 0.5 per cent of soap. The curves then bend round sharply and the surface tension remains constant or else increases very slightly with increasing concentration of soap. The Gibbs equation would therefore suggest that positive adsorption only takes place in solutions containing less than 0.5 per cent soap and that above this concentration adsorption becomes slightly negative; this in spite of the fact that the actual value of the surface tension remains small—a fact which presupposes the continued existence of the adsorbed surface layer. It appears, however, that the Gibbs equation is not applicable in the usual simplified form;

$$\Gamma = - \frac{d\sigma}{d\mu}$$

The assumptions made in its derivation (that only two components are present); that the osmotic pressure is a linear function of the concentration of the solute; neglect of electrical effects), are not fulfilled in soap solutions owing to their complexity.<sup>1,2</sup> Furthermore, no allowance is made for possible variation of the extent of the adsorption layer; thus introducing an unwarranted *a posteriori* assumption concerning the layer itself.

This complexity is due to part of the solute being molecularly dispersed and part colloiddally; both parts are also in hydrolytic equilibrium. An aqueous soap solution therefore contains:

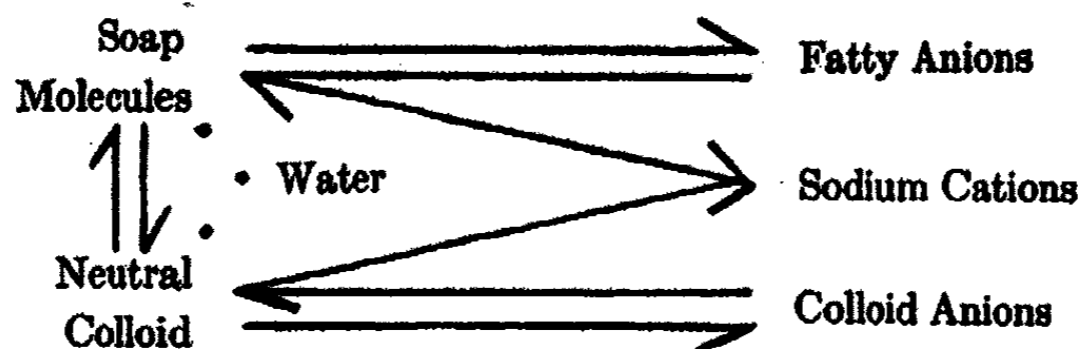

It has long been known that the surface layer of a soap solution has an acid reaction. The conclusion has been drawn from this observation that the adsorbed layer is composed of hydrolysed acid; and it was compared with the thin films formed by the free fatty acids on water. The incorrectness of this view has been established by McBain by complete analysis of the adsorbed layer. He estimated the amount of acid and alkali carried over at the surface of a large number of bubbles blown through a soap solution and found sufficient acid to form approximately a bi-molecular layer together with three-fifths of the alkali required to neutralise this acid. He suggests that the adsorbed solute is present as an oriented monomolecular layer to which is attached about as much again in an irregular manner as shown diagrammatically in Fig. 1. Sir W. Hardy has shown that films of some stability can be prepared from water covered by a monomolecular layer of oleic acid.<sup>4</sup> It is the additional reserve in the soap film that accounts for its greater strength and ready extensibility. This picture of McBain's of the surface layer of soap solutions is supported by observations on the thinning of soap films.

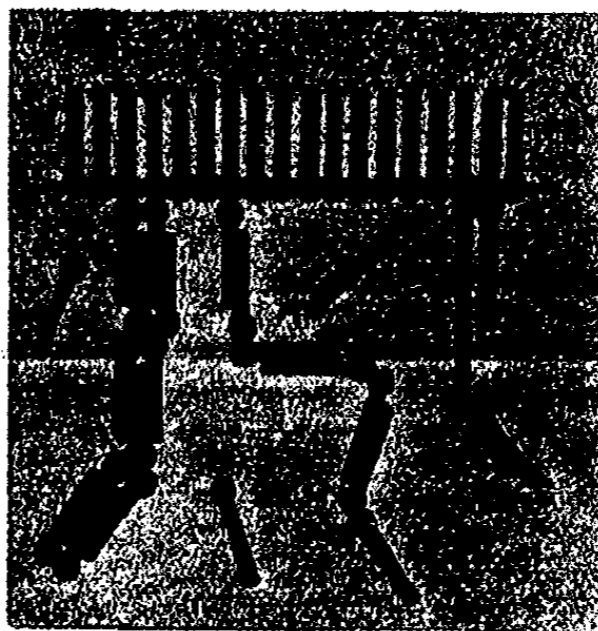

FIG. 1

#### The Thinning of the Soap Film

When first formed, the soap film is too thick to show colour by interference in white light; it quickly thins, however, sufficiently for the familiar colours to appear. When the thickness of the film becomes less than about a quarter of the wave length of the illuminating light, interference no longer produces colour and the film appears (in white light) silvery-white. A peculiar change then sets in; a black spot appears in the highest part of the film. The boundary between this black spot and the next thicker part of the film is always sharp and remains while the black spot increases in area until it has invaded the whole of the film. The black film is about  $12\mu\mu$  thick and the silvery-white 100; at the boundary there is therefore a sudden step up in thickness.

In a film of infinitely small thickness, the retardation of the internally behind the directly reflected ray would be negligible; there is only the phase change of the directly reflected light; interference would be complete and the film would appear quite dark. Actually, in the thinnest soap films, the thickness, although finite, is small compared with the wave lengths of visible light; there is only therefore a small amount of light reflected—about one five-hundredth of that reflected from the silvery-white film.

It must be pointed out that the formation of the black spot is not always so simple as this description suggests. Newton first observed two grades of black film. Later Johonnott,<sup>8</sup> by microscopic examination of the black,

found no less than five. This appears to be the maximum but there still remains a large gap between the thickest black and the thinnest "coloured" film—the silvery white as the following table shows:—

First order black	6 $\mu$	Fourth order black	24 $\mu$
Second " "	12 "	Fifth " "	30 "
Third " "	28 "	Silvery-white	100 "

It is important to observe that the films and bubbles of great stability\* prepared by Sir James Dewar were all blacks of the second order.<sup>9</sup> The first order blacks are much less stable while the higher orders are quite ephemeral and never large in area.<sup>10</sup>

According to the suggested constitution of the soap film the black will consist of the two surface layers; most if not all the interior liquid having drained away. This will be the second order of black. When the thickness is compared with the length of the soap molecule, it is clear that there does still remain some of the interior liquid; without its presence the film could not be more than 8 to 10  $\mu$  thick. The higher orders of black appear during the thinning of films made from rather dilute solutions and require undisturbed development. Their origin is, no doubt, the chains which McBain has suggested occurring beneath the surface-oriented layer. This view puts the maximum effective depth of the adsorbed layer at five molecules (long).

It is unusual, if indeed it ever occurs, for the first order of black to be formed from the second without other manifestations of a disturbed development.\*\* My view of the process is that it involves the rupture of one of the surface layers; the film then either breaks or else coalescence of the interior liquid takes place according to surface tension requirements on the remaining surface layer. An orientation of the adsorbed molecules beneath the remaining surface layer will be required to form the first order of black which only consists of two monomolecular oriented surface layers containing a small amount of interior liquid. Even if the film survives this very considerable transformation, it will still be much less stable than the second order of black owing to the lack of any reserve of adsorbed fatty material beneath the two surface layers. Strange as this inversion appears, there is considerable experimental evidence that my explanation is correct. The most striking point is that the rate of coalescence of the blacks to form the first order increases as their thickness decreases, the growth of the first order of black in the second being especially rapid. Now this is quite contrary to what would happen if the drainage were still proceeding between two surface layers; for in that case halving the thickness would reduce the rate to one sixteenth; whereas in actual facts the rate is *increased* several times.

#### Stratified Soap Films

The stratified soap films discovered by Perrin<sup>1</sup> and the bimolecular "leaflets" from which he supposed these films to be built up are not a simple

\* The solutions used contained a considerable amount of glycerin—10 times the concentration of soap; it is rare for such solutions to give 1st order black films.

\*\* Full particulars of abnormal developments will be found in the author's "Soap Films."

extension of Johonnott's five blacks but form a class by themselves. It cannot be too strongly urged that these films are abnormal and results obtained from their examination are not necessarily applicable to soap films in general. I have shown elsewhere that the formation of these stratifications is essentially the separation of a solid component although the stratifications behave at first as though liquid.\* It differs from adsorption in that it is not restricted to the surface but goes on throughout the film. It is rather of the nature of a crystallisation. It is noteworthy that the formation of these stratified films requires the use of very concentrated soap solutions. Perrin assumed that the adsorbed layer in soap solutions contains no alkali because it has an acid reaction and that, in consequence, his elementary "leaflets" were bimolecular layers of oleic acid. More recently McBain has shown that there is in the adsorption layer three-fifths of the alkali required for neutrality. The process of stratification suggests the formation of an insoluble component and its subsequent separation in lamellar form. Its insolubility requires the suppression of the carboxyl groups to form a sheet similar to those formed by the solid fatty acids. It appears probable that the stratifications are actually acid soap. A small quantity of caustic soda solution added to a solution giving good stratified films, inhibits this behaviour. Acid potassium oleate has been prepared by crystallisation from alcoholic solution and has the requisite lamellar form.<sup>11</sup> There is not sufficient evidence to decide whether there is any water present in these stratifications or not.

A completely analogous state of affairs has been observed in surface films by Lyons and Rideal.<sup>12</sup> Palmitic acid, which forms monomolecular films on acid water surfaces, is found to form an insoluble bimolecular film on alkali. The solution of the monomolecular film on addition of alkali results in the formation of molecules of soap which become submerged in the water and then link up with the remaining fatty acid molecules on the surface thus forming a sheet of acid soap of twice the thickness of the original monomolecular film. There is no reason for the formation of a molecule of acid soap of the formula;  $\overline{HOI};\overline{KOI}$ ; but it is easy to see how a crystal could be formed in which the unit cell contained two molecules of fatty acid and two of soap instead of four of fatty acid. It seems therefore that the formation of these stratifications is a purely crystalloidal and not a colloidal phenomenon.

#### Colloidal Soap Films

The clearest proof that freely-thinning soap films are not colloidal is provided by the abnormalities of films which do develop a colloidal structure. First however, it is necessary to distinguish between a colloidal structure for the surface layers and for the film as a whole.\*\* As regards the former, whatever its properties, it is rather a strain on colloid nomenclature to suggest that the surface layer two molecules thick, just described, has a gel structure. There

\* "Soap Films," p. 58 (1929).

\*\* There does not seem to be any reason for expecting surface activity in polypeptides. The simplest amino-acids are only slightly adsorbed in aqueous solution. Freundlich: "Colloid and Capillary Chemistry," 641 (1926).

is evidence that colloiddally dissolved substances do not lower the surface tension of their solvents to any great extent; it has also been suggested that the fatty anion cannot lower it either.<sup>11</sup> The work of duNoüy already mentioned completely refutes this idea; at the enormous dilutions employed by him, hydrolysis is certainly complete and the surface activity must be due to the fatty anion. In any case experience of black films supports the view that they can remain truly liquid and mobile.

It has also been suggested that the soap film has a colloidal structure as a whole.<sup>12</sup> It is known quite definitely that there must be interior liquid even in the thinnest films. Reinhold and Rucker observed that when the thickness of a soap film becomes less than about  $300\mu$ , its electrical conductivity begins to rise in an abnormal manner but that disturbance of the film reduces it. They also found that addition of nitre or other electrolyte prevents this abnormal rise. Since electrolytes are negatively adsorbed, their presence in the black film definitely proves the inclusion of interior liquid. There can be no doubt that, when first formed, the soap film contains colloid particles, since all soap solutions contain them. But the ease with which these particles are oriented by a flow of liquid<sup>14</sup> owing to their characteristic thread-like shape makes it highly probable that they are oriented in the plane of a film just by the action of forming it. Drainage will keep them oriented in this manner and draw them out from between the surface layers in the ordinary course of drainage. When the black films obtained from aqueous soap solutions in exhausted tubes break, a peripheral ring of gel frequently remains. It sometimes happens, also, that a bubble, normal at first, develops a colloidal structure and becomes gelatinous. This occurs in bubbles blown from sodium oleate containing saturated impurities such as stearic and palmitic acids. Certain colloidal solutions have a viscosity which is variable depending on the rate of shear; if this is small enough the viscosity is enormous. Pure sodium oleate is not elastic; pure sodium stearate is slightly so but a mixture of the two substances<sup>15</sup>, is elastic out of all proportion to its constituents. Bubbles blown from such solutions thin partially and then no further; they become gelatinous and have a characteristic vertically striped appearance which supports my view of the orientation of the colloid particles. It is obvious that owing to the enormous viscous resistance to flow of the interior liquid in a soap film, and the consequently small shearing rate, the conditions are exceptionally favourable to the appearance of this abnormal elasticity. The reason for such bubbles thinning partially and then becoming gelatinous is usually the result of blowing up a bubble with a newly prepared solution. Ageing goes on for a day or so and after this time a bubble will not usually increase in viscosity in situ. It is interesting to observe that there is no improvement in the film-forming capacity of the solution as a result of this ageing; another piece of evidence that this property does not depend on the colloiddally dissolved components of the solution.

One final piece of evidence against any form of gel structure for soap films may be included. Ammonium oleate solutions lose their base rather easily and the viscosity of the solution increases but no oleic acid separates. If,



now, to this solution ammonia is added to make up for the deficit, it sets to a gel which only slowly reverts to the normal fluid condition of the neutral solution. Fig. 2 shows an attempt to form a film on a four-inch wire ring. When the ring was lifted out of the gel, a film was formed but it was a very odd one. It was nearly half black when first formed; the remainder being silvery-white in the middle while the lower part was very thick only showing high orders of Newton's bands. On the right hand side can be seen a lump of jelly caught up by the ring but clearly discontinuous from the black film. It may also be observed that at least three orders of black are visible.

So far I have described ordinary soap films in which there are no signs of inherent colloidal constitution; such films consist of a sandwich structure which consists of a pair of surface layers of adsorbed molecularly dispersed soap enclosing between them a variable amount of soap solution. Under certain conditions this internal liquid may develop a colloidal structure in situ but there is no evidence that the surface layers are in any way colloidal. There is however, a type of film in which the surface layer and therefore the stability of the film depends on the colloidal properties of the surface layer.

The best known example of this type of film and bubble is those formed from saponin solutions.

If a bubble is blown from a solution of saponin, nothing peculiar is observed except that little if any thinning goes on. If now air is sucked out from the bubble again, a surprising change ensues. Instead of retaining its spherical form during contraction, as a soap bubble does, it is drawn in laterally and becomes puckered in a most curious manner; on further contraction it assumes the form shown in Fig. 3; it can be seen that the two surface layers are being drawn together and the internal liquid squeezed out to form the drop at the bottom. If left to itself at this stage the bubble regains a more or less spherical form.

In this case of the saponin bubble we are quite justified in speaking of a surface "skin." The solutions of this substance have a superficial viscosity enormously greater than that of the solution; the surface skin can actually be seen and handled; it even shows difficulty of re-solution. All this goes to show that we are dealing with a state of affairs very different from that in the soap bubble. This is no monomolecular layer. The surface tension of the saponin solution is lowered by adsorption; but the solute on reaching the surface seems to undergo some transformation so that it is no longer surface-active and more solute is adsorbed only to be transformed in turn. In this manner most of the solute reaches the surface to form a veritable skin which



FIG. 2

is truly colloidal. For this reason such bubbles are not, like soap bubbles, almost indefinitely extensible and are rarely obtained larger than 4 inches diameter.

The origin of the *saponaceous and colloidal* properties of soap. To understand the film-forming and colloidal properties of soap solutions it is necessary to form a quite definite picture of the soap molecule. The simplest soaps are the alkali salts of the homologous fatty acid series whose general formula is  $C_nH_{2n}O_2$ . The constitution of the higher soap-forming members is better understood when their formula is written:

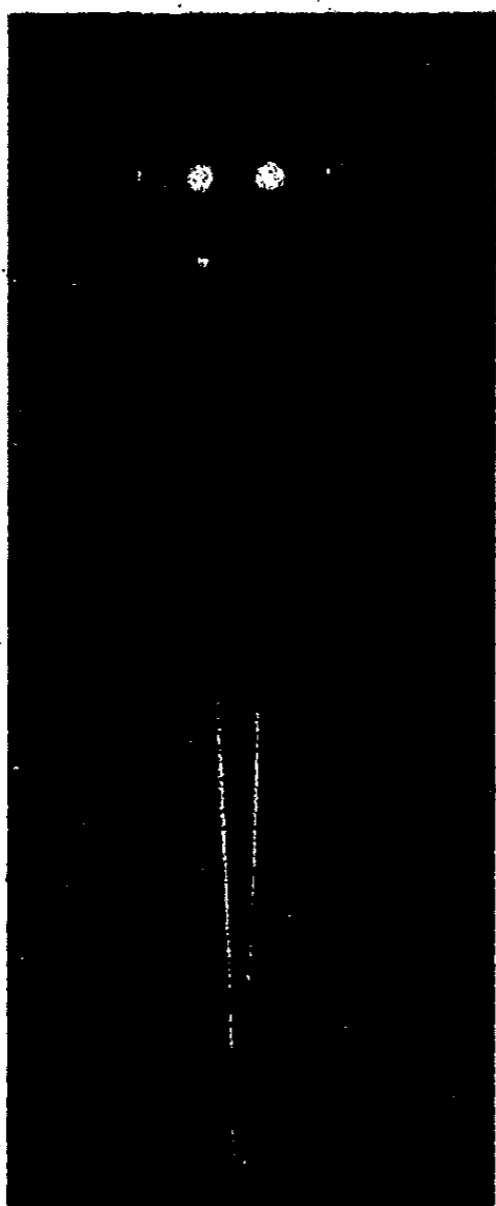
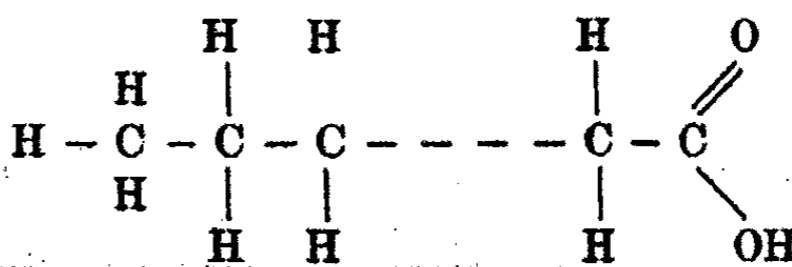

FIG. 3



The molecule consists of two parts; a hydrocarbon chain which varies in length from one carbon atom in acetic to 29 in mellissic, the highest member known; and, secondly, a carboxyl group. Now the hydrocarbon chain is insoluble in water whereas the carboxyl group has a powerful affinity for it. The result is that in the lower members the carboxyl group can carry the molecule, as a whole, into solution. Colloidal properties first appear in solutions of the caproates in which the chain is 5 carbon atoms long;<sup>16</sup> from this point upwards in the series colloidal properties become more apparent since the influence of the carboxyl group is constant throughout the series while the hydrocarbon chain becomes longer and longer. This forms an interface with the water and so tends to reduce the free surface energy of the system by aggregating to colloidal particles.

These colloidal particles are therefore formed by aggregation of the hydrocarbon chains to a particle which presents the carboxyl groups outwards to the solvent action of the water. In alcoholic solution, the hydrocarbon chain is soluble as well as the carboxyl group; consequently no colloid particles are formed. Such solutions do not froth either because no oriented adsorbed surface layer is formed. In benzene solution, we have a state of affairs directly opposed to aqueous solutions. The chain is truly stable; the carboxyl group insoluble. Association therefore takes place at the carboxyl groups but stops with the formation of a double molecule. In the higher members (lauric for example) the association is less complete than in the lower membranes since

as the chain lengthens so does the solvent action of the non-aqueous solvent become more dominant.

The form of the soap molecule is also responsible for another property; the marked lowering of the surface tension of water. As we ascend the series, the surface tension lowering effect increases with the length of the molecule but it is not until we reach caprylic acid ( $C_8$ ) that the large surface activity characteristic of the soaps appears.<sup>17</sup> Ascending the series we find the rather curious fact that by the time we reach arachidic ( $C_{20}$ ) the surface activity has suddenly disappeared again. However the colloidal properties of these higher members show no diminution; in fact there is a steady increase.

Of this series the soap-forming acids are from lauric ( $C_{12}$ ) to stearic ( $C_{18}$ ); while the higher members, arachidic, behenic and cerotic (20, 22 and 26) exhibit diminishing traces of this property. The explanation is quite simple in view of the facts. The formation of a stable soap film requires the following conditions:

(a) The lowering of the surface tension of water to about one third by the formation of an oriented adsorbed layer of molecularly dispersed solute.

(b) That this oriented surface layer should have an effective lateral cohesive strength greater than the disruptive force of the residual surface tension.

As we ascend the homologous fatty acid series the first condition is fulfilled by the time we reach caprylic. At this stage, however, the second condition is not fulfilled nor does this occur until the lateral cohesion has been sufficiently increased by the addition of four more carbon atoms to the chain so bringing us to lauric which is the first soap-forming acid in the homologous series.\* The reason that above stearic the soap-forming properties largely disappear is that the colloidal aggregation of the soaps increases continuously with every additional carbon atom in the chain until by the time it is 20 carbon atoms long, the solute is almost entirely colloiddally dissolved and the bimolecular surface layer of molecularly dispersed soap no longer formed. It seems certain, however, that sufficient molecularly dispersed soap remains in solution to form the surface-active layer but the number of these molecules is so, comparatively, small that the time taken by them to reach the surface enters into the question. In boiling solution even behenates become soaps since there are more molecules free and the surface layer is formed more rapidly.

#### Conclusion

In conclusion we can say that both the film-forming capacity and the colloidal properties of soap solutions result from the peculiarity of the form of the molecules of soaps. Actually this peculiarity consists of a rare simplicity; a fact which explains why out of some quarter of a million chemical substances known, only a few dozen are soaps. The isolated position of the

\* The rare  $C_{11}$  acid—Undecic—is in a truly intermediate position and it cannot be stated definitely to be or not to be a soap forming acid. The  $C_{10}$  acid—Capric is quite definitely not soap-forming.

single water-soluble group in an otherwise insoluble molecule is the origin both of colloidal properties and of film-forming capacity. But the latter requires other conditions to be fulfilled so that while all soaps happen to be colloids, only a few colloids are soaps.

Colloidal films exist but they are quite different from soap films. To exhibit the characteristic properties a soap film must be truly liquid; such colloidal soap films as do exist are abnormal in this respect. In any case they do not form a link with truly colloidal films since in the latter it is the surface layer which is colloidal whereas in the former it is the interior which develops a gel structure.

The experimental work discussed here was carried out at the Royal Institution, London, partly in the course of the late Sir James Dewar's work and partly by the author at a later date by kind permission of Sir William Bragg.

#### References

- <sup>1</sup> Perrin: *Ann. Phys.*, (9) 10, 165 (1918); P. V. Wells: 16, 79 (1921).
- <sup>2</sup> Lord Rayleigh: *Proc. Roy. Soc.*, 47, 281 (1890).
- <sup>3</sup> Freundlich: "Colloids and Capillary Chemistry," 796, 1842 (1926).
- <sup>4</sup> Rickenbacher: *Arch. Sci.*, 40, 329 (1915).
- <sup>5</sup> du Noüy: *Phil. Mag.*, 48, 264, 664 (1924).
- <sup>6</sup> McBain: *Colloid Symposium Monograph* (1928).
- <sup>7</sup> McBain: *J. Am. Chem. Soc.*, 49, 2230 (1927).
- <sup>8</sup> Johannott: *Phil. Mag.*, (5) 47, 501 (1899); (6) 11, 751 (1906).
- <sup>9</sup> Dewar: "Collected Papers," 2, 1182.
- <sup>10</sup> Dewar: "Collected Papers," 2, 1171.
- <sup>11</sup> McBain and Stewart: *J. Chem. Soc.*, 1927, 1393.
- <sup>12</sup> Lyons and Rideal: *Proc. Roy. Soc.*, 124A, 344 (1929).
- <sup>13</sup> Bottazzi: Alexander's "Colloid Chemistry," 2, 121-163.
- <sup>14</sup> Hardy: *J. Chem. Soc.*, 127, 1225 (1925).
- <sup>15</sup> Gagenbach: *Arch. Sci.*, 35, 329 (1913).
- <sup>16</sup> Freundlich: "Colloid and Capillary Chemistry," 408.
- <sup>17</sup> Freundlich and Kores: *Kolloid-Z.*, 36, 241 (1925).
- <sup>18</sup> Mayer, Schaeffer and Terroine: *Compt. rend.*, 146, 484 (1908).
- <sup>19</sup> Lascaray: *Kolloid-Z.*, 34, 73 (1924).
- <sup>20</sup> Walker: *J. Chem. Soc.*, 119, 1521 (1921).

July 15, 1929.

35  
51

## THE STRUCTURE OF GELATIN SOLS AND GELS\*

### I. The Viscosity of Gelatin Solutions

BY S. E. SHEPPARD AND R. C. HOUCK

The study of the "viscosity" of gelatin solutions has been complicated by the fact that such solutions below a certain temperature level show a dependence of the rate of flow upon the shearing stress. This phenomenon, very general with colloids and "high molecular" bodies, has been entitled variously "plastic flow," "structure viscosity," and the like.

In the case of gelatin solutions, this behavior appears to be definitely related to gelation, as shown by the correlation of increase of apparent viscosity with time, or aging, of solutions below the so-called setting temperature. Davis and Oakes<sup>1</sup> in an important memoir, brought evidence to show that this increase of "apparent viscosity" with time ceased at a certain temperature, at which the viscosity became *independent* of the time. They considered their data gave evidence for a definite critical "transition temperature" of sol→gel forms of gelatin, at 38.03°C. It was shown by R. H. Bogue<sup>2</sup> and independently by S. E. Sheppard, F. A. Elliott and S. S. Sweet<sup>3</sup> that the temperature at which plasticity or structure viscosity effects disappeared depended upon the concentration of the gelatin solution. They concluded from this that there is no critical transition temperature of sol form to gel form but only a temperature zone of transition from sol state to gel state.

The possibility, however, of temperatures existing for which the viscosity is independent of the time, or age of the solution, is of great importance, even if that temperature should prove dependent upon the concentration and other factors. Such invariant temperatures would be of great importance for the comparative testing and standardizing of gelatins, even if their theoretical significance were doubtful. Our investigation was directed, therefore, primarily to ascertain:

- a. Whether a definite temperature exists at which the viscosity becomes independent of the time.
- b. If such an invariant temperature exists, whether independent of pH, concentration, origin of gelatin, etc.

In following through these questions, particularly in regard to the relation of viscosity to pH, certain interesting relations of the rate of change of viscosity to pH were discovered, which appeared to link up the behavior of gelatin solutions more definitely with that of known homogeneous systems.

#### Experimental

The materials used were a good grade commercial calf-skin gelatin, and two lots of Eastman "de-ashed" gelatin brought to close approximation to

\* Communication No. 395 from the Kodak Research Laboratories.

the tentative specifications for Standard Gelatin which were proposed at the American Chemical Society meeting in September, 1928.<sup>4</sup> The moisture contents were determined, and the solutions made up on a dry weight at 105°C. basis. The procedure for preparing the solutions was as follows: After the gelatin sheet had been cut in small pieces, they were placed in a volumetric flask, water equal to five times the weight of gelatin was added, and the gelatin allowed to soak for one hour at 25°C. Fifty cubic centimeters of water at 52°C. were then added and solution finished at 52°C., this being apparently complete in thirty minutes. The water necessary to make solution 6.9 percent on a weight normal, 7.0 percent on a volume normal basis, was then added, and the solution transferred to a thermostat at the temperature indicated. After a lapse of thirty minutes for the solution to come to temperature, 5.0 c.c. were transferred to an Ostwald type viscosity pipette, and the time of flow was measured. From this, together with the density of the solution and the calibration constant of the pipette, the viscosity was calculated. This was the "apparent viscosity," assuming the validity of the Poiseuille-Hagenbach formula. For lower temperatures, where gelation is occurring, and the "apparent viscosity" is rising, this assumption is incorrect, but does not invalidate the consideration of the trend of the value with time.

The solutions used in time studies were kept sterile by addition of various antiseptics, as thymol, isoeugenol, chloroform, and toluol. In certain experiments, the solutions were sterilized by heating in steam for twenty to thirty minutes, incubating, and reheating. A number of antecedent conditions were examined for their possible effect on the viscosity of a solution prepared according to the procedure detailed.

#### Time of Soaking

Experiments showed that increasing the time of soaking in water at 25°C. above one hour did not change the viscosity.

#### Temperature of Dissolution

The best temperature would very reasonably be one at which the rate of peptization and solution is as high as possible compatible with slight actual chemical breakdown or hydrolysis. Since hydrolysis is always proceeding in the solutions, and increases rapidly with rise of temperature, the choice is somewhat arbitrary.

Manning<sup>5</sup> has stated that if a gelatin solution is made up at the temperature at which its viscosity is to be measured, there is a rapid initial *fall* in its viscosity, measured at this temperature, whereas if dissolved at a higher temperature and cooled down to this lower operating temperature the viscosity will not fall but remain constant for several hours. We found this to be relatively correct as regards the initial fall in viscosity, provided the operating temperature is not too low, but did not secure the constant viscosity. For an operating temperature of 40°C., a gelatin solution made up at 40°C. shows a

greater *initial* fall of viscosity than one made up at 52°C. (see Fig. 1) but both rapidly approach to the same rate of fall of viscosity, not to a constant viscosity. As the operating temperature is higher, the initial falls become nearer each other.

The nature of the process of solution of gelatin at given temperatures still requires much study, in order that the parts played therein by swelling, dispersion, true solution, and hydrolytic decomposition may be more definitely distinguished. From the point of view furnished by the present

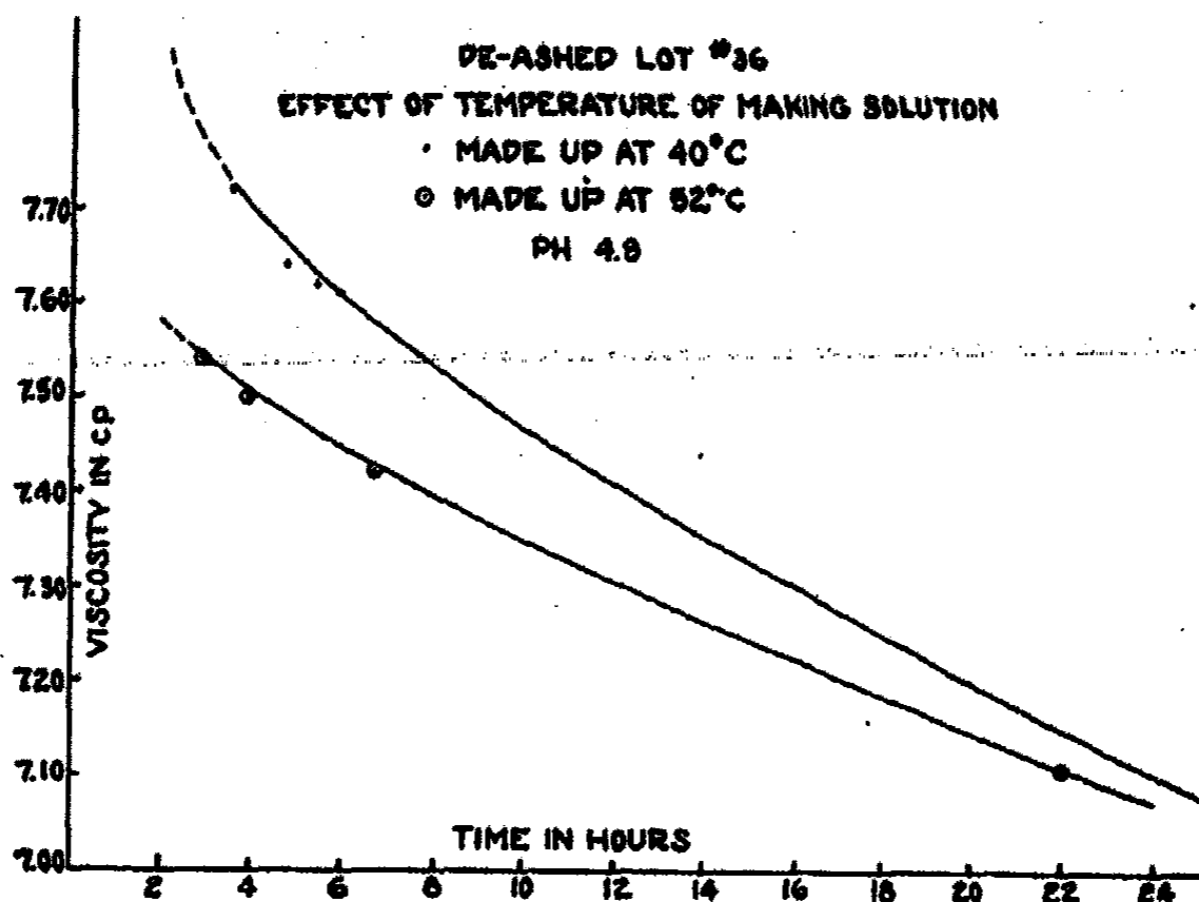

FIG. 1

investigation, it appears that the time of any preheat period above 40°C. should be curtailed as much as possible, in order to reduce the amount of hydrolysis. In our experiments, we have adhered to a preheat of thirty minutes at 52°C., and find that both the time and temperature of preheat must be kept constant if comparable results on the viscosity are to be secured.

#### Viscosity as a Function of pH

The results of different workers on the viscosity of gelatin sols at different pH values and different temperatures have been somewhat contradictory. J. Loeb<sup>6</sup> has given curves showing "viscosity" as a function of pH at 25°C., showing a maximum at pH 2.9 and a minimum at pH 4.7 to 4.8. At such a temperature, the solutions, at any rate over a certain pH range and above a certain concentration, are tending to gelatinize. They are not purely viscous<sup>7</sup> but show plasticity and "structure viscosity," which is also increasing with time.<sup>8</sup> Consequently, the graphs of apparent viscosities given by Loeb have very doubtful significance. R. H. Bogue<sup>9</sup> has given one curve of viscosity against pH showing a maximum at pH 3, a minimum at pH 4.9, and a second maximum around pH 9.

Davis and Oakes<sup>10</sup> gave a similar curve for a gelatin solution at 40°C., as did also Freundlich and Neukircher<sup>11</sup> and Loebel<sup>12</sup>. On the other hand, Davis and Salisbury<sup>13</sup> have published results for several gelatins, all showing maxima at pH<sub>3</sub>, but in only one case, a particular commercial gelatin, did they find a definite minimum around pH<sub>5</sub>.

#### The Concentration Factor

Practically all these results were obtained with relatively dilute solutions, from 1 to 3 percent. It is well known that various attempts have been made to develop a formula expressing the viscosity of a colloidal solution as a function of the concentration.<sup>14</sup> These attempts have been more successful

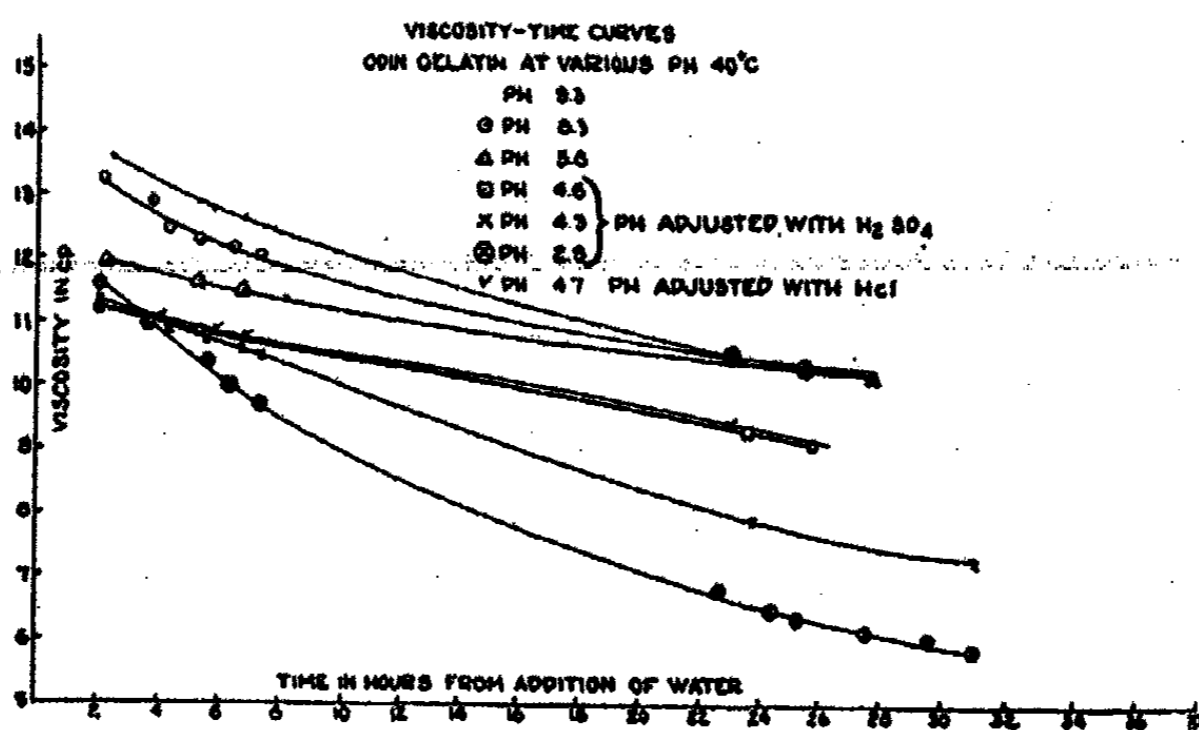

FIG. 2

for the so-called lyophobic or unsolvated colloids than for the lyophilic or solvated ones.<sup>15</sup> In the case of gelatin, there appear to be certain factors which make it improbable that anything more than a very limited range of concentration could be covered. First, at relatively low temperatures, the sols are possible only at low concentrations, and these sols, in the iso-electric region, are not stable, but show syneresis.<sup>16</sup> Moreover, the investigations of Kunitz and Northrop<sup>17</sup> indicate that this syneresis or precipitation is actually a fractionation, separating a less soluble from a more soluble component. Evidently such systems are too indeterminate for any functional relation of viscosity to concentration to mean much, since the state and composition are not invariant with regard to time. On the other hand, the solutions at relatively high temperatures, which do not show plastic flow, but are purely viscous, are also varying because of hydrolysis, the viscosity decreasing steadily with time. Here again the condition with regard to time appears to preclude the development of a function relating viscosity to concentration.

#### Change of Viscosity with Time at Various pH and Temperature Values

We considered, therefore, that a study of the change of viscosity with time over a wide range of pH values and at different temperatures was the



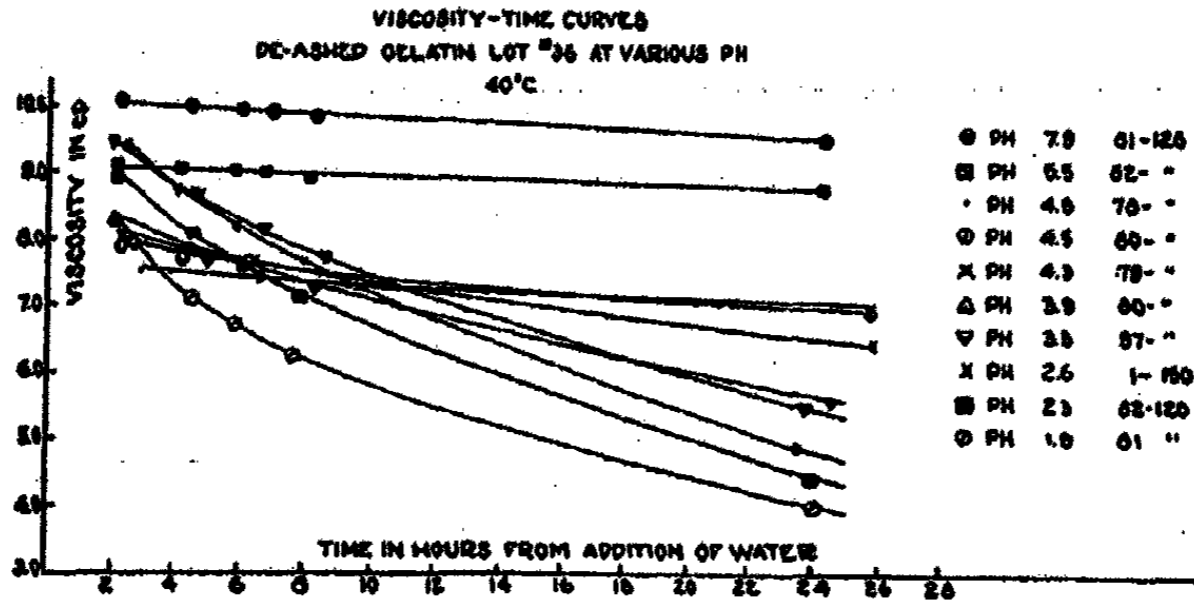

FIG. 3

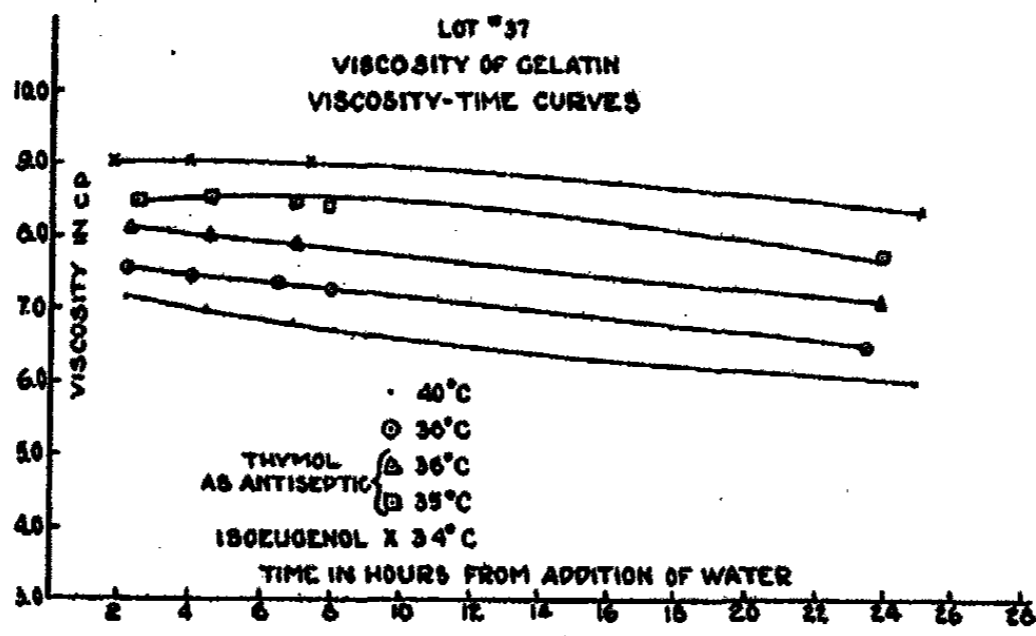

FIG. 4

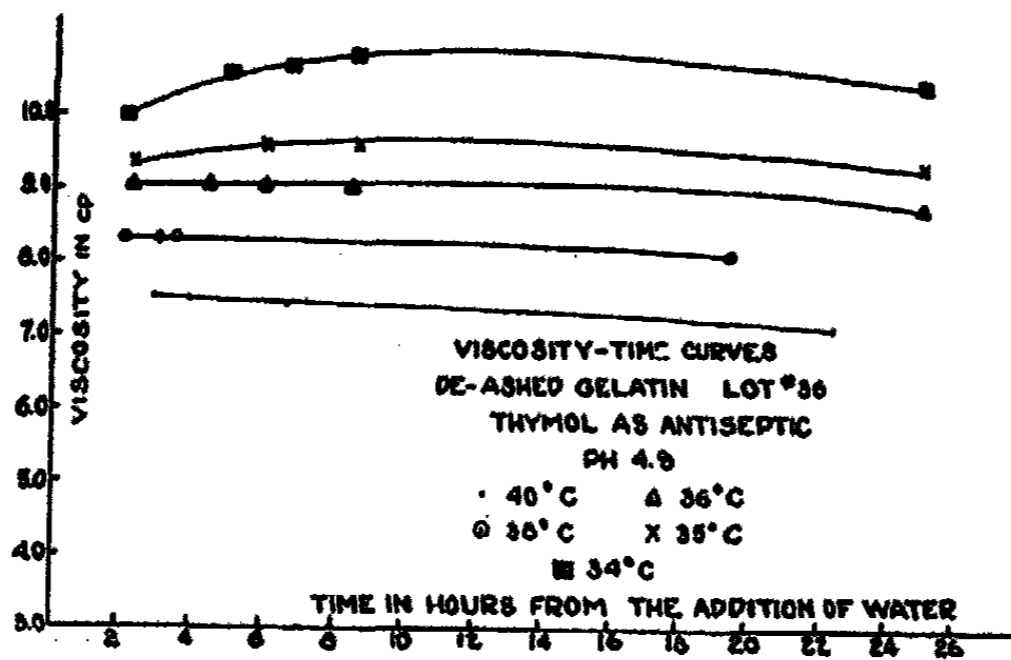

FIG. 5

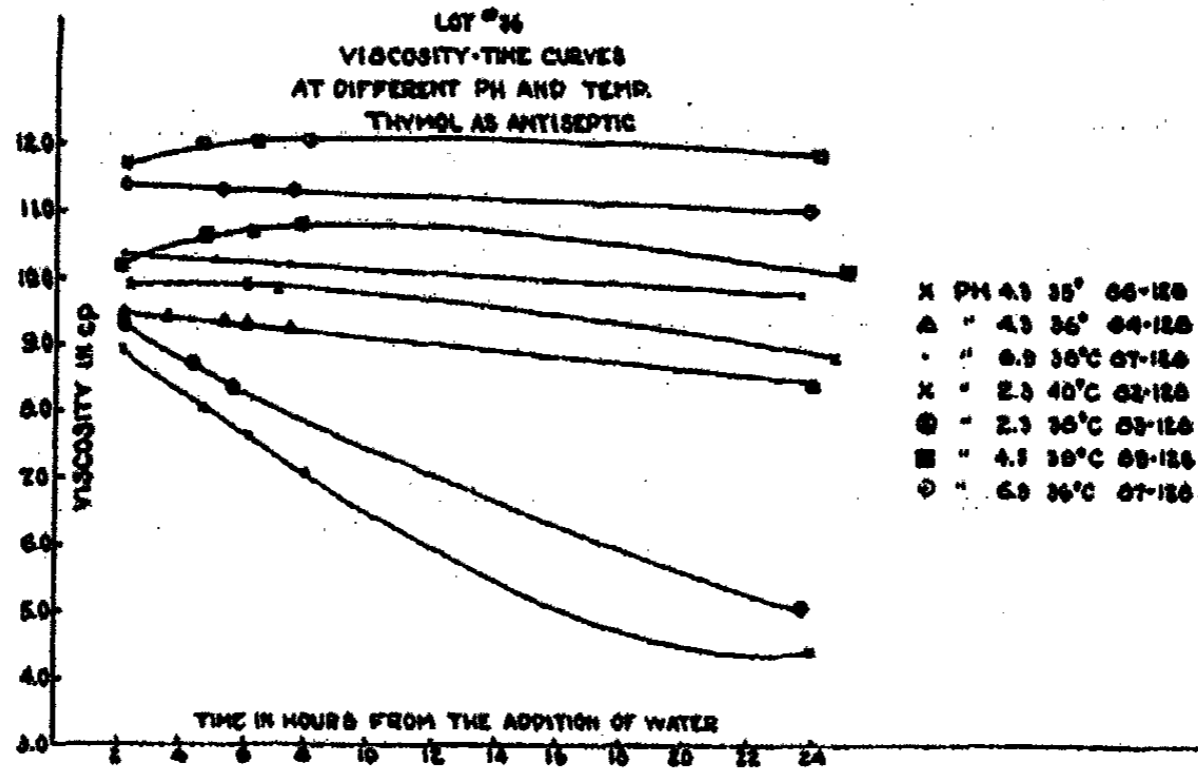

Fig. 6

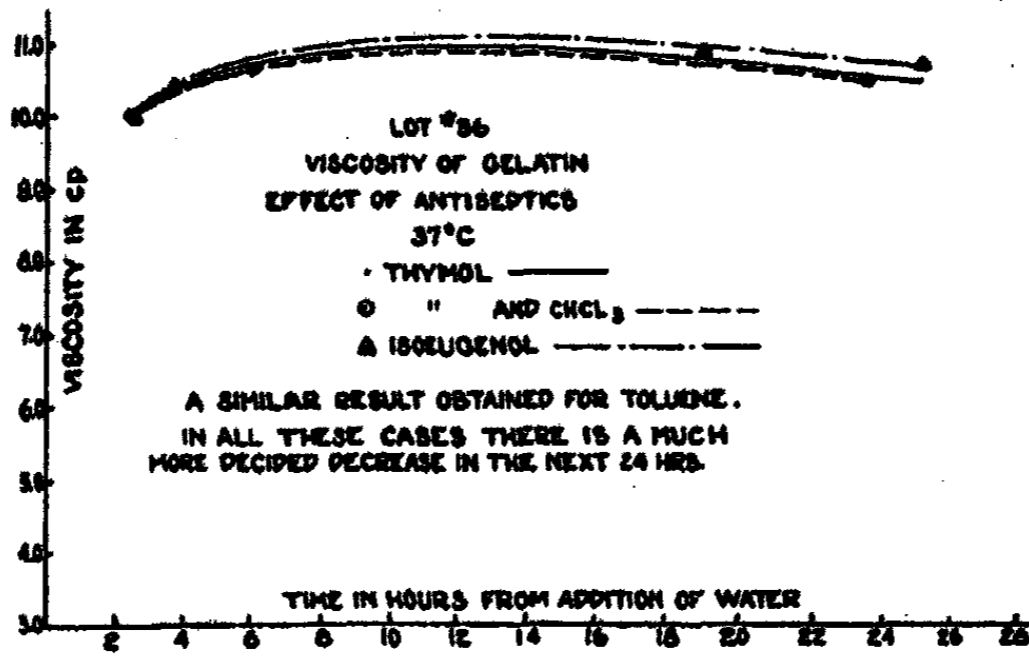

Fig. 7

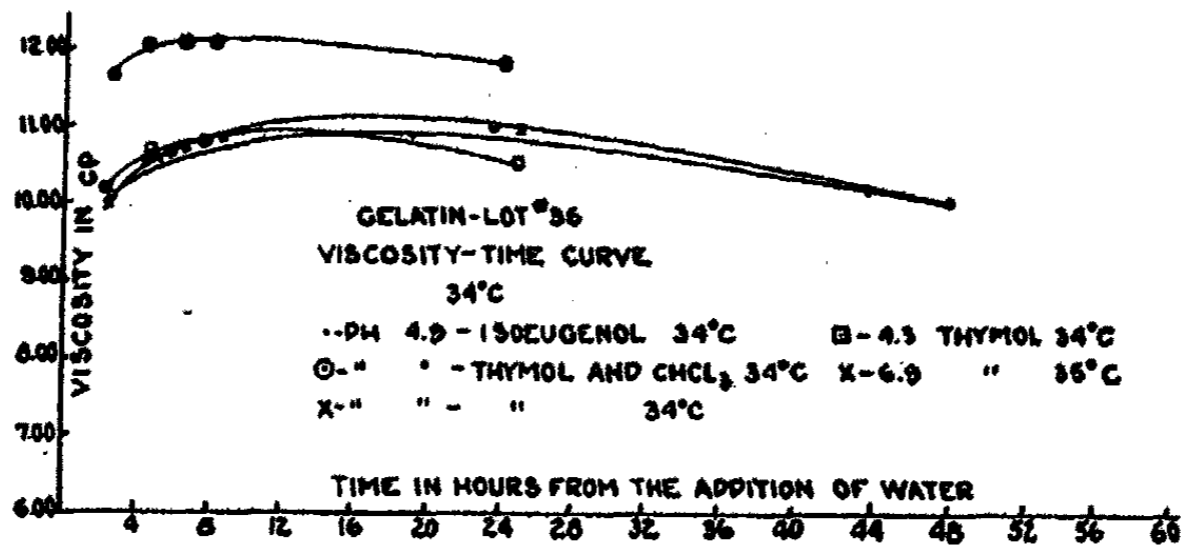

Fig. 8

first requirement. In view of the tendency to select a higher concentration of gelatin for viscosity specifications,<sup>18</sup> the experiments were carried out at a concentration, as already noted, of 7.0 percent. It appeared desirable to make an extensive study of the phenomena at one concentration before varying this factor. Incidentally, the data bear on the question of the existence of a critical transition temperature for sol→gel forms of gelatin, as deducible from the existence of a temperature at which the viscosity does not change with time. The data are given in Tables I to VI, and shown graphically in Figs. 2 to 8. These experiments indicate that comparable results for the viscosities of gelatin solutions are possible only with gelatin sols of definite pH of the same age at constant temperature. The data do not support the view that a definite temperature exists for which the viscosity is independent of time. With these solutions, at 7 percent, sols of the same pH kept below a certain temperature zone showed a steady increase of "apparent viscosity" with time, which we regard as due to gelation.<sup>19</sup> For temperatures above this zone, they showed steady fall of viscosity with time. In an intermediate zone, which also depends upon the pH, the viscosity first rises, and then falls. Hence, there did not appear to be any temperature at which the viscosity is truly independent of time.

It has been suggested that a rise in viscosity, followed by a steady fall, is due to bacterial attack. However, in our experiments we found this phenomenon to occur, fairly reproducibly, in presence of different antiseptics, and with no evidence of bacterial decomposition (*cf.* Figs. 7 and 8). To check the matter more conclusively, we took more concentrated solutions (to allow for hydrolytic breakdown), enclosed these completely sealed in a combined viscometer and conductivity cell (*cf.* Fig. 9). These solutions were sterilized by successive heatings in steam followed by incubations, and both viscosity and conductivity measured at different periods of time at given constant temperatures. These were considerably lower than for solutions kept sterile with antiseptics, owing to the accelerated hydrolysis during steaming having destroyed considerable gelatin. However, the curves (Figs. 10 and 11) show that here again there is a region of temperature for which there is first a rise of viscosity to a maximum, followed by a steady fall. Yet there was no change in conductance such as would be produced by bacterial attack liberating ammonia.<sup>20</sup> The nature of the process or processes affording this rise to a maximum is a matter of interest. We consider that this represents the combination of gelation and hydrolysis effects. Although the rate of hydrolysis decreases rapidly with fall of temperature (*vide*

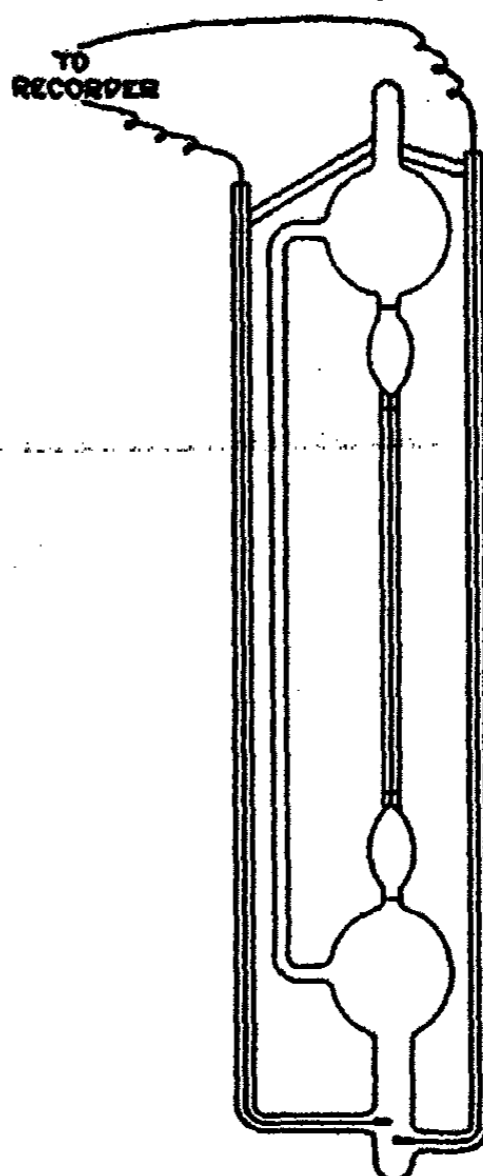

FIG. 9  
Combined Viscometer and  
Conductivity Cell

*infra*) it does not disappear. At the temperatures and pH values in question, hydrolysis will be proceeding at a certain rate. If no gelation occurred, the viscosity would fall steadily toward a limiting value. But since there is initially a certain concentration of unhydrolyzed gelatin, there is an initial moment of gelation the temperature being sufficiently low. This implies aggregation of the gelatin molecules and micelles, and binding of water, increasing the viscosity.<sup>21</sup> The gelation, however, is not sufficient to offset the hydrolysis, so that after an initial rise the viscosity then falls off.

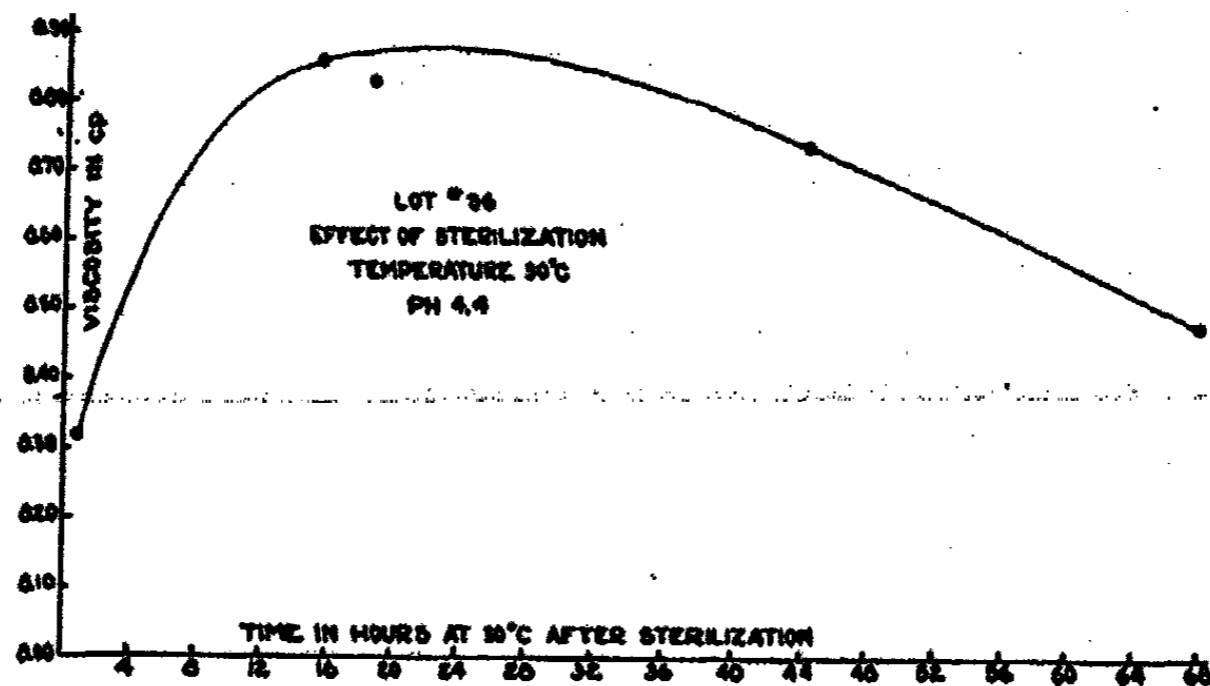

FIG. 10

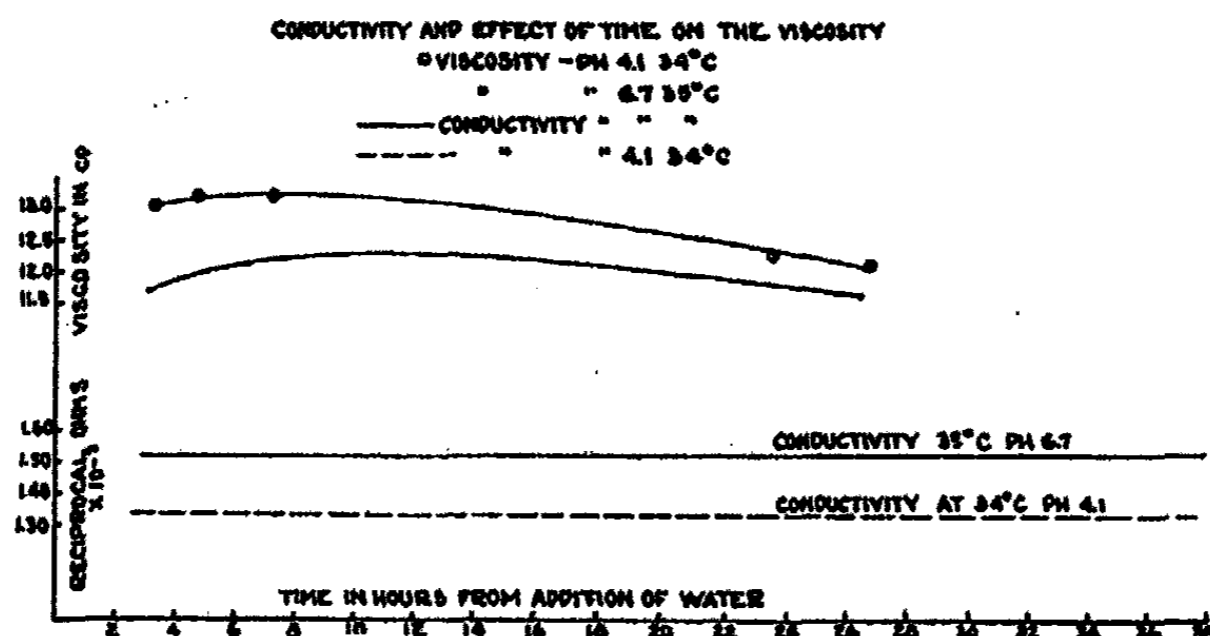

FIG. 11

A condition such that the viscosity of the solution was independent of time would occur:

a. Because both aggregation (gelation) and hydrolysis were entirely absent.

b. Because the aggregation balanced the hydrolysis.

Condition (a) is excluded, since hydrolysis will not be entirely absent. Condition (b) is not perhaps impossible, but seems unlikely to be realized. Pos-

sibly the conditions would be more favorable, the less the fluctuations of temperature in the system. In our experiments the temperature was regulated only to 0.05 to 0.10°C. Further work is planned on the viscosimetry and pyknometry of gelatin solutions with much closer regulation of temperature.

**Shape of Viscosity: pH Curve**

From our experiments it appears that the shape of the viscosity:pH curve is largely determined by the age of the solution. This is illustrated in Fig. 12

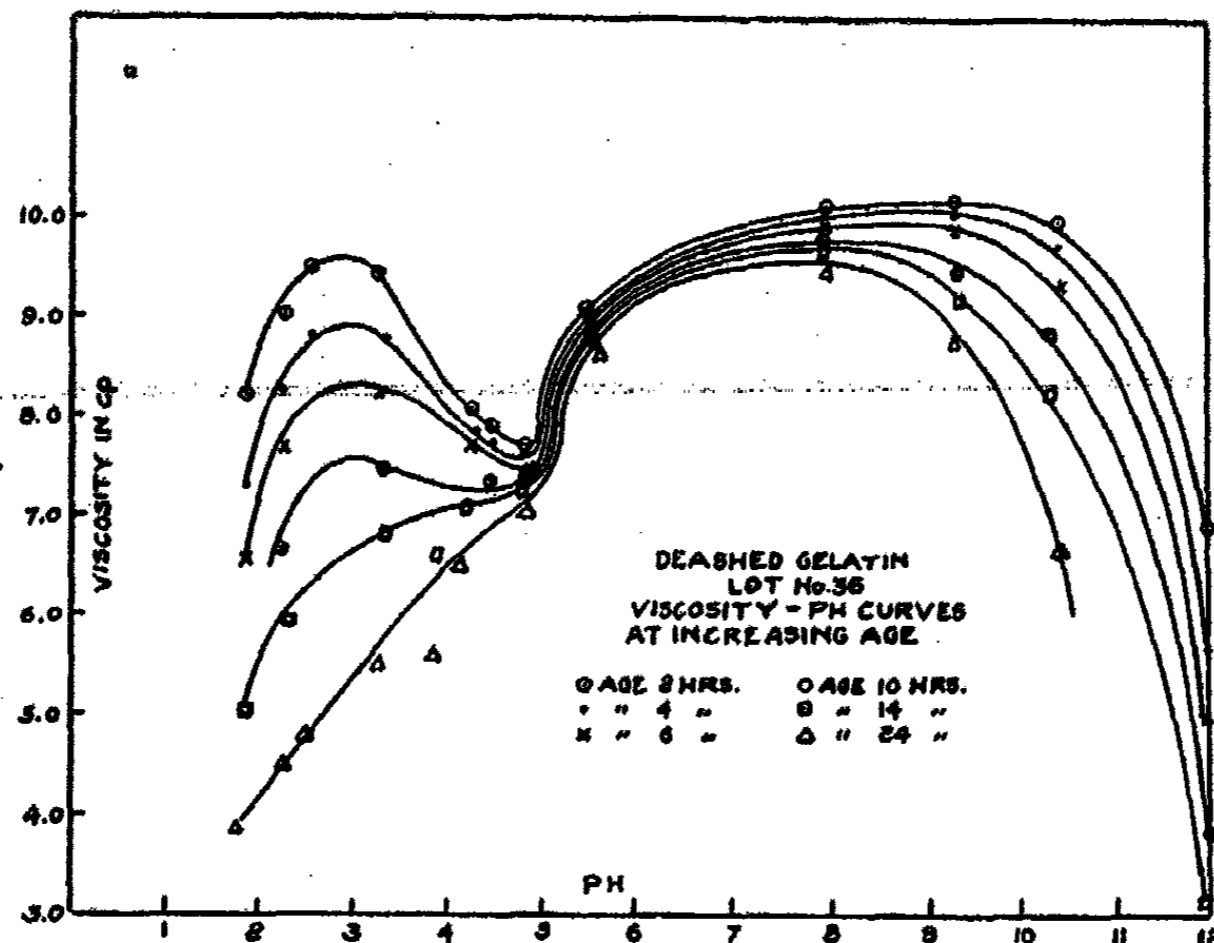

FIG. 12

**TABLE I**  
Effect of Time on the Viscosity of Odin\* Gelatin  
Viscosity in Centipoises at Different pH and Age

Age in Hours	pH						
	2.9	4.30	4.6	4.7	5.8	8.3	9.3
2	11.65	11.35	11.30	11.35	12.05	13.25	13.75
4	10.85	11.00	11.00	11.00	11.75	12.60	13.45
6	10.15	10.70	10.80	10.90	11.50	12.20	12.75
8	9.5	10.36	10.62	10.70	11.35	11.90	12.40
10	8.95	10.00	10.45	10.50	11.18	11.65	12.10
12	8.50	9.70	10.30	10.35	11.03	11.44	11.80
14	8.10	9.40	10.10	10.18	10.90	11.24	11.55
16	7.75	9.10	9.95	10.00	10.77	11.05	11.30
18	7.40	8.75	9.72	9.85	10.65	10.87	11.05
20	7.10	8.45	9.60	9.65	10.55	10.70	10.80
22	6.80	8.15	9.40	9.40	10.45	10.50	10.55
24	6.55	7.90	9.26	9.33	10.35	10.42	10.30

\*A commercial calf-skin gelatin.

TABLE II  
 Effect of Time on the Viscosity of Gelatin, Lot No. 36  
 Viscosity in Centipoises at Different pH and Age

Age in Hours	pH													
	1.9	2.3	2.6	3.3	3.9	4.3	4.5	4.9	5.5	6.7	7.9	9.3	10.4	12.0
2	8.20	9.00	9.50	9.45	8.25	8.07	7.92	7.55	9.10	9.75	10.05	10.2	10.0	6.90
4	7.30	8.25	8.80	8.80	7.88	7.88	7.75	7.51	9.05	9.70	10.00	9.85	9.7	5.35
6	6.65	7.65	8.25	8.25	7.57	7.70	7.62	7.47	9.02	9.65	9.95	9.80	9.45	4.60
8	6.17	7.13	7.70	7.80	7.30	7.54	7.52	7.43	9.00	9.62	9.90	9.60	9.20	4.05
10	5.80	6.70	7.30	7.45	7.05	7.40	7.38	7.38	8.96	9.58	9.85	9.45	8.90	3.65
12	5.47	6.33	6.90	7.12	6.80	7.20	7.33	7.33	8.94	9.55	9.80	9.30	8.60	3.40
14	5.17	5.98	6.52	6.85	6.57	7.07	7.30	7.30	8.90	9.53	9.75	9.15	8.40	3.20
16	4.93	5.67	6.15	6.58	6.35	6.95	7.25	7.25	8.88	9.50	9.70	9.00	8.15	3.00
18	4.70	5.37	5.80	6.32	6.15	6.80	7.20	7.20	8.85	9.47	9.65	8.85	7.90	2.85
20	4.48	5.07	5.45	6.05	5.95	6.70	7.15	7.15	8.83	9.45	9.60	8.75	7.70	2.70
22	4.25	4.80	5.15	5.77	5.77	6.60	7.12	7.12	8.80	9.43	9.55	8.65	7.50	2.60
24	4.00	4.50	4.80	5.50	5.57	6.50	7.07	7.07	8.77	9.40	9.50	8.50	7.20	2.45

TABLE III  
 Viscosity-time Curves for Gelatin No. 36 at Different Temperatures  
 pH 4.9. Antiseptic-Thymol  
 Viscosity in Centipoises

Age in hours	34°C.	35°C.	36°C.	40°C.
2	9.96	9.32	9.05	7.57
4	10.42	9.50	9.05	7.50
6	10.68	9.58	9.05	7.45
8	10.83	9.63	9.05	7.41
10	10.87	9.65	9.05	7.37
12	10.90	9.63	9.03	7.34
14	10.86	9.60	9.03	7.30
16	10.83	9.55	9.02	7.25
18	10.75	9.50	9.01	7.20
20	10.65	9.45	8.99	7.16
22	10.57	9.40	8.92	7.12
24	10.50	9.35	8.85	7.07

TABLE IV  
 Viscosity-time Curves for Gelatin No. 36 at Different pH and Temperatures  
 Thymol as Antiseptic  
 Viscosity in Centipoises

Age in Hours	pH 2.3		pH 4.3		pH 4.5		pH 6.9	
	38°C.	40°C.	35°C.	36°C.	34°C.	35°C.	36°C.	38°C.
2	9.42	8.95	9.90	9.45	10.20	11.65	11.42	10.37
4	8.77	8.30	9.92	9.40	10.55	11.90	11.39	10.32
6	8.25	7.65	9.90	9.32	10.65	12.05	11.35	10.26
8	7.80	7.03	9.84	9.27	10.80	12.10	11.31	10.20
10	7.40	6.45	9.75	9.12	10.80	12.14	11.27	10.15
12	7.03	5.92	9.62	9.00	10.77	12.14	11.24	10.10
14	6.67	5.45	9.50	8.90	10.70	12.10	11.20	10.05
16	6.35	5.05	9.36	8.80	10.60	12.05	11.17	10.00
18	6.00	4.72	9.24	8.70	10.50	12.00	11.15	9.94
20	5.65	4.50	9.10	8.60	10.38	11.93	11.10	9.89
22	5.30	4.40	8.95	8.48	10.25	11.87	11.05	9.83
24	4.95	4.35	8.85	8.38	10.13	11.82	11.00	9.75

TABLE V  
 Viscosity-time Curves for Gelatin No. 37 for Increasing Temperature  
 Antiseptic: Thymol except at 34°C, when isoeugenol was used. pH 4.7  
 Viscosity in Centipoises

Age in Hours	34°C.	35°C.	36°C.	38°C.	40°C.
2	9.02	8.40	8.15	7.58	7.20
4	9.04	8.52	8.03	7.48	7.00
6	9.02	8.55	7.95	7.35	6.85
8	9.00	8.51	7.85	7.25	6.70
10	9.92	8.45	7.75	7.15	6.60
12	9.85	8.36	7.65	7.05	6.50
14	9.75	8.25	7.57	6.95	6.40
16	9.68	8.15	7.48	6.85	6.30
18	9.60	8.02	7.40	6.75	6.22
20	9.54	7.90	7.30	6.65	6.15
22	9.45	7.80	7.20	6.55	6.08
24	9.37	7.70	7.10	6.45	6.00

TABLE VI  
 Viscosity-time Curves Gelatin No. 36, Effect of Antiseptics  
 Temperature 34°C. pH 4.9  
 Viscosity in Centipoises

Age in Hours	Thymol as Antiseptic	Thymol and CHCl <sub>3</sub> as Antiseptic	Isoeugenol as Antiseptic
2	9.95	9.90	9.95
4	10.45	10.42	10.50
6	10.70	10.68	10.80
8	10.82	10.81	10.98
10	10.87	10.85	11.08
12	10.87	10.85	11.08
14	10.85	10.80	11.07
16	10.80	10.75	11.03
18	10.74	10.70	10.95
20	10.70	10.64	10.90
22	10.60	10.57	10.82
24	10.55	10.49	10.73



The change with time appeared to take place in a quite regular manner (see next section). Johlin<sup>23</sup> has shown that with such solutions—gelatin above 40°C., dilute soap solutions—the surface tension varies with time in a regular manner, and suggests that this occurs only in the case of colloidal solutions in which the solute is highly dispersed in a manner similar to that of true solutions.

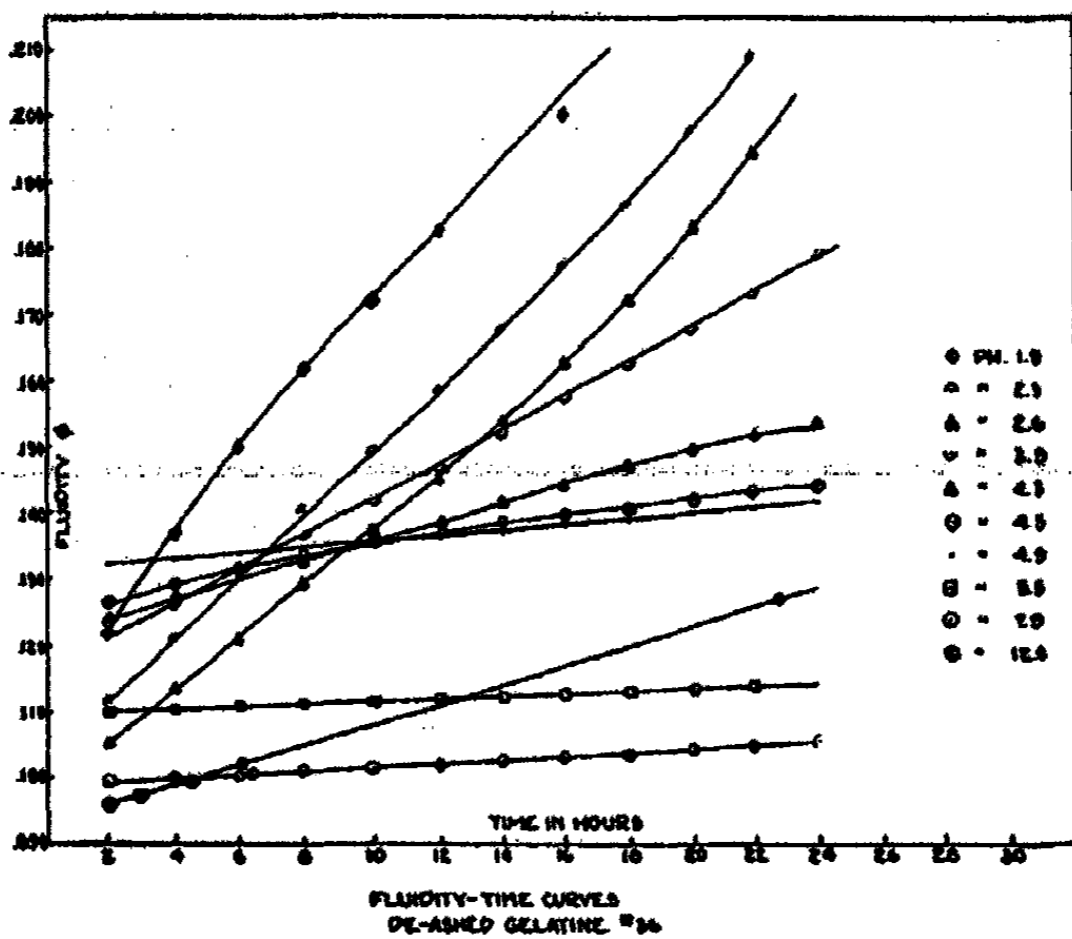

FIG. 13—Hydrolysis at 40°C.

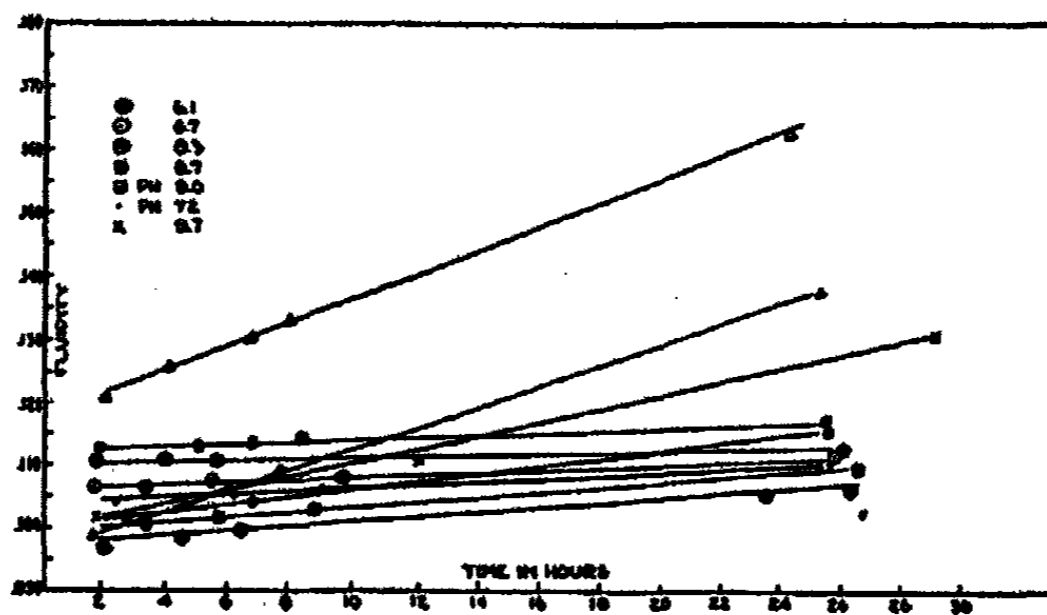

FIG. 14  
Fluidity-time Curves De-ashed Gelatin No. 36 Hydrolysis at 40°C.

**Hydrolysis and pH**

In solutions above a certain temperature when the viscosity falls steadily with time, it is probable that this fall is entirely due to hydrolysis. In order to follow the rate of change, it appeared desirable to plot *fluidities*, i.e., the reciprocals of viscosities, against time, for different pH values. These curves

of  $\phi = 1/\eta$  against time (cf. Figs. 13 and 14) were found to give fairly straight lines for the initial period of change. We deemed it reasonable, therefore, to take the slopes  $\Delta\phi/\Delta t$  as a measure of the velocity of change of fluidity.

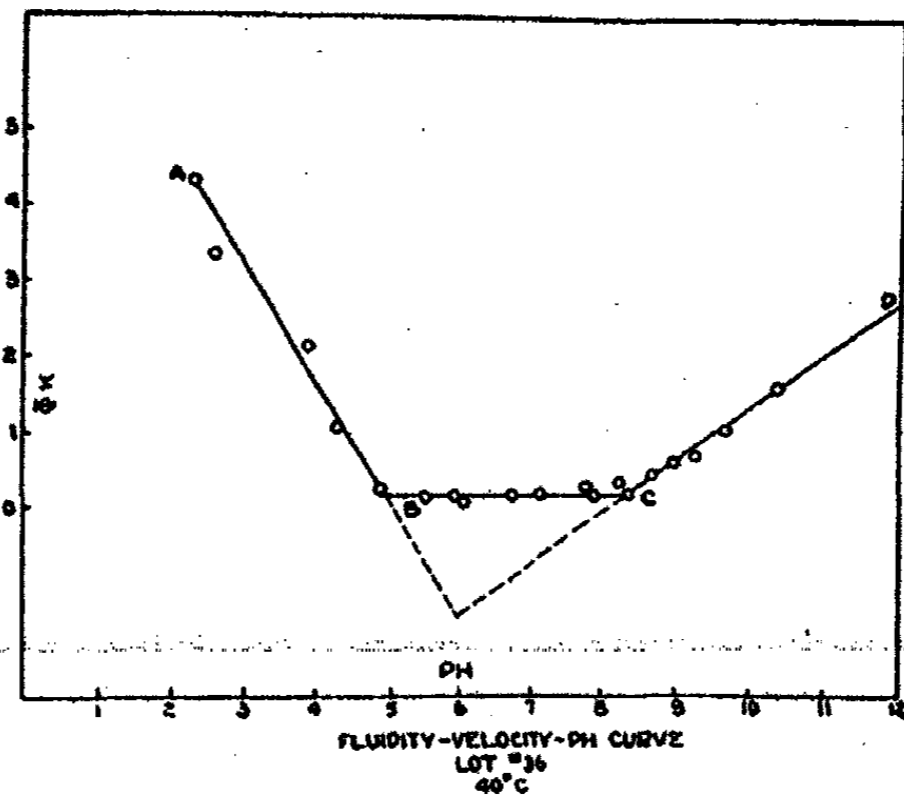

FIG. 15

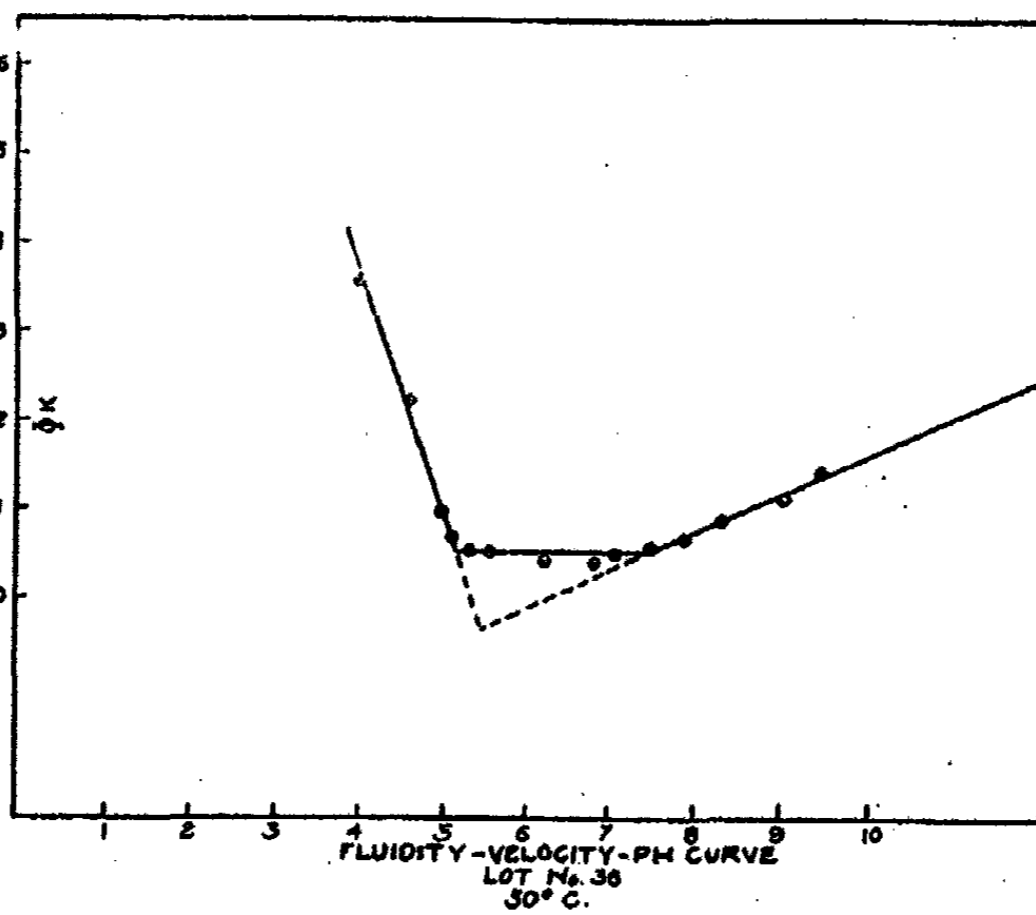

FIG. 16

On plotting this value  $\phi_k = \Delta\phi/\Delta t$  against pH, the following graphs were obtained (cf. Tables VII to XIII, and Figs. 15 to 17): It will be seen that the graphs consist of inclined straight lines, which meet when protracted (at 40°C.) at pH 6, but are intercepted by a horizontal portion between pH 5 to pH 8. It is evident that this graph is very similar, first and specifically, to the graphs obtained by Northrop<sup>23</sup> when plotting log K as a function of

pH, where K is the velocity constant of hydrolysis of gelatin measured chemically by formol titration (cf. Figs. 18 and 19), and secondly and generally, to the graphs obtained by Skrabal<sup>24</sup> on plotting  $p_k = \log K$  against pH, where again K is the velocity constant of homogeneously catalyzed reactions, such as hydrolysis, esterification, mutarotation, in aqueous solutions.

TABLE VII  
Viscosity-time Curves, Gelatin No. 36, Effect of Antiseptics at Different pH and Temperature  
Viscosity in Centipoises

Age in Hours	34°C.				35°C.
	pH 4.3. Thymol as Antiseptic	pH 4.9 Thymol as Antiseptic	pH 4.9 Thymol and CHCl <sub>3</sub> as Antiseptic	pH 4.9 Isoeugenol as Antiseptic	pH 6.9 Thymol as Antiseptic
2	10.20	9.95	9.90	9.95	11.60
4	10.57	10.45	10.42	10.50	11.95
6	10.75	10.70	10.68	10.80	12.10
8	10.85	10.82	10.81	10.98	12.10
10	10.90	10.87	10.85	11.08	12.10
12	10.95	10.87	10.85	11.08	12.07
14	10.93	10.85	10.80	11.07	12.05
16	10.90	10.80	10.75	11.03	12.03
18	10.85	10.74	10.70	10.95	12.00
20	10.77	10.70	10.64	10.90	11.95
22	10.68	10.60	10.57	10.82	11.90
24	10.57	10.55	10.49	10.73	11.85

Skrabal points out that for such reactions the generalized equation holds:

$$dx/dt = k_w + k_1 [\overset{+}{H}] + k_2 [\overset{-}{OH}] (a - x)$$

or if  $a - x = 1$

$$K = k_w + k_1 [\overset{+}{H}] + k_2 [\overset{-}{OH}]$$

where  $k_w$  = velocity constant for neutral water. This is a generalized form of the "catalytic catenary" of Hudson.<sup>25</sup> If values are taken such that

$$-\log [\overset{+}{H}] = \text{pH}$$

$$\log K = p_k$$

and  $p_k$  is plotted as a function of pH, a graph is obtained of intersecting straight lines; this may be regarded as consisting of a left limb corresponding to hydrion catalysis, a right limb corresponding to hydroxyl ion catalysis, and an intermediate flat "stability" or iso-electric region of neutral water catalysis. The fact that the data for  $\phi_k$  as a function of pH follow the same general law as the chemical logarithmic velocity coefficient  $p_k = \log K$  certainly indicates a close connection between them. It may be noted that our data for  $\phi_k$  at 40°C. give an intersection point of the  $[\overset{+}{H}]$  and  $[\overset{-}{OH}]$  lines at

TABLE VIII  
Fluidity-time Curves De-ashed Gelatin No. 36  
Increasing pH  
40°C. Fluidities

Age in Hours	pH									
	2.3	2.6	3.9	4.3	4.9	5.5	6.1	6.7	7.2	
2	0.111	0.105	0.121	0.124	0.1325	0.110	0.1102	0.1065	0.1045	
4	.121	.114	.127	.127	.1332	.1195	.1105	.1067	.1050	
6	.131	.121	.132	.130	.1338	.1108	.1107	.1072	.1055	
8	.140	.130	.137	.133	.1345	.1111	.1110	.1075	.1060	
10	.149	.137	.142	.135	.1355	.1115	.1112	.1080	.1065	
12	.158	.148	.147	.139	.1363	.1118	.1115	.1085	.1070	
14	.167	.153	.152	.142	.1370	.1123	.1117	.1090	.1075	
16	.177	.163	.158	.144	.1379	.1125	.1119	.1094	.1080	
18	.186	.172	.163	.147	.1388	.1130	.1120	.1097	.1085	
20	.197	.184	.168	.149	.1398	.1132	.1122	.1102	.1090	
22	.208	.194	.173	.152	.1405	.1136	.1124	.1105	.1095	
24	.220	.208	.180	.154	.1414	.1140	.1129	.1107	.1100	

TABLE VIII (Continued)  
 Fluidity-time Curves De-ashed Gelatin No. 36  
 Increasing pH  
 40°C. Fluidities

Age in Hours	pH									
	7.9	8.3	8.7	9.0	9.3	9.7	10.3	12		
2	0.0995	0.0982	0.099	0.1015	0.0980	0.1020	0.1000	0.1450		
4	.1000	.0990	.1010	.1270	.1005	.1040	.1030	.1868		
6	.1005	.0997	.1017	.1040	.1020	.1060	.1057	.2172		
8	.1010	.1005	.1025	.1053	.1043	.1080	.1087	.2468		
10	.1015	.1012	.1035	.1064	.1057	.1105	.1124	.2737		
12	.1020	.1020	.1042	.1075	.1075	.1125	.1162	.2940		
14	.1025	.1026	.1050	.1087	.1093	.1147	.1190	.3120		
16	.1031	.1035	.1057	.1100	.1110	.1167	.1227	.3330		
18	.1036	.1042	.1065	.1112	.1130	.1190	.1265	.3508		
20	.1041	.1050	.1075	.1124	.1143	.1210	.1300	.3700		
22	.1047	.1057	.1082	.1136	.1166	.1230	.1334	.3890		
24	.1052	.1064	.1091	.1147	.1177	.1252	.1470	.4076		

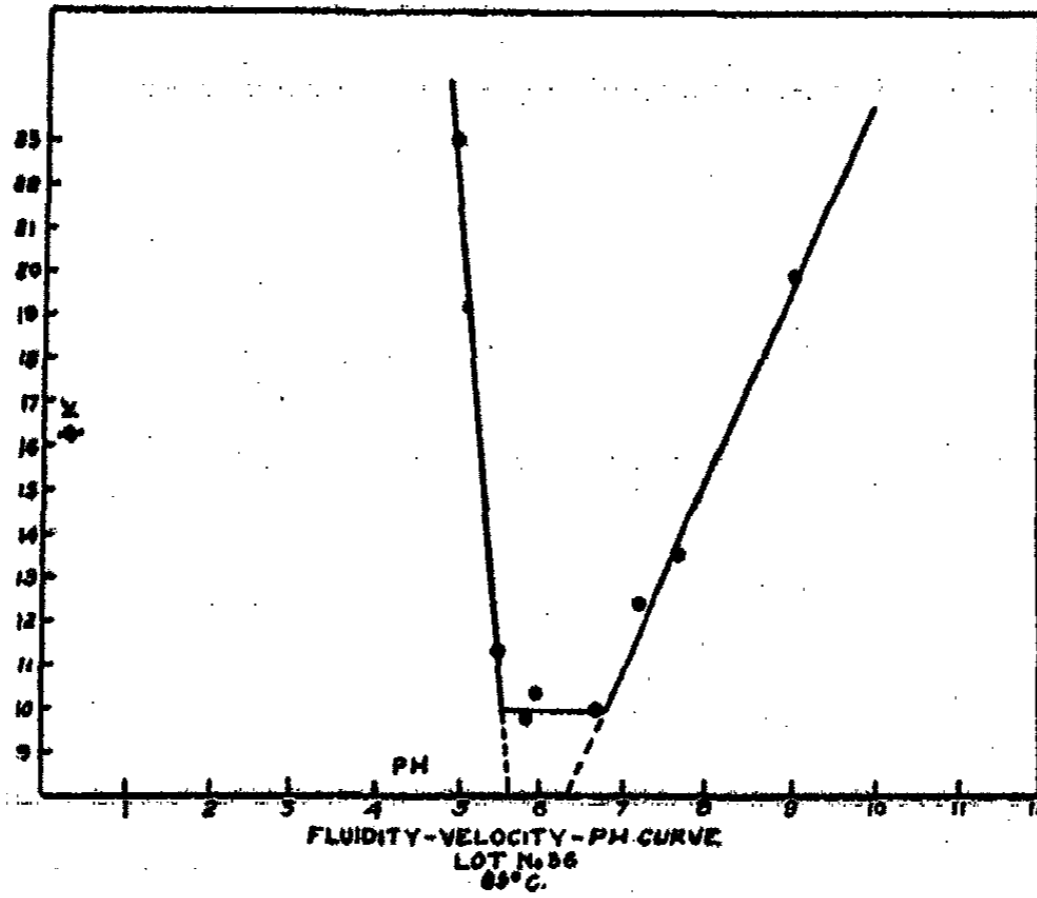

FIG. 17

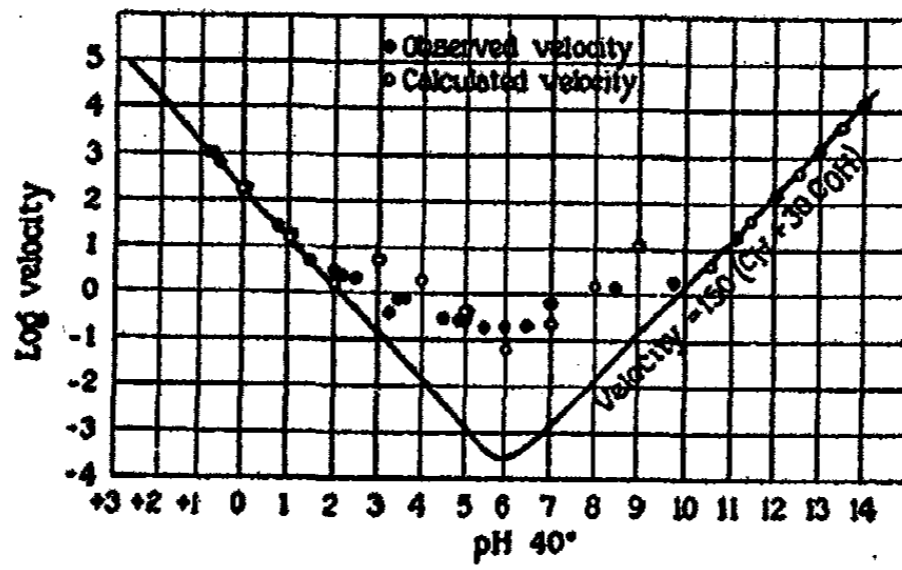

FIG. 18

(Northrop: J. Gen. Physiol., 3, 715 (1921) ).

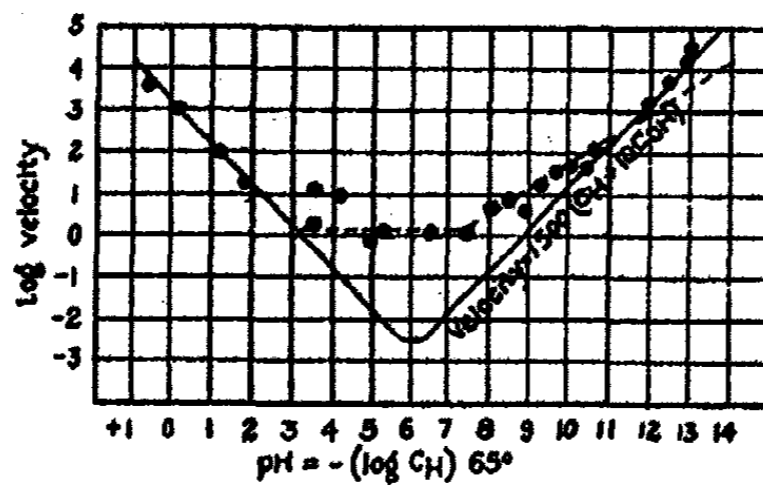

FIG. 19

(Northrop: J. Gen. Physiol., 3, 712 (1921) )

pH 6, exactly as found by Northrop for his measurements of  $\log K$ , chemically. Northrop's data show a much wider and higher "stability region"—about pH 2 to pH 10—than our pH 5 to pH 8. The reason for this is probably due to Northrop's use of buffered solutions in this interval. Northrop states<sup>26</sup> "In strongly acid or alkaline solutions it is not necessary to use buffers since the change in pH during the hydrolysis of the gelatin is negligible. Between pH 1.5 and 11.0, however, it is necessary to use some buffer, as otherwise the pH of the solution changes rapidly during the course of the reaction."

It is possible that the extent of hydrolysis considered in Northrop's experiments was greater than in ours, but over the periods of our experiments we did not find any considerable variation of pH, but on the contrary sub-

TABLE IX  
The Effect of pH on Change of Fluidity of Gelatin Sols with Time  
Gelatin No. 36

40°C		40°C	
pH	$\phi_k$	pH	$\phi_k$
2.3	4.27	6.7	.170
2.6	3.39	7.2	.230
3.9	2.15	7.9	.300
4.13	1.12	8.3	.381
4.9	0.2907	8.7	.450
5.5	0.162	9.0	.630
5.9	0.164	9.3	.76
6.1	.104	9.7	1.02

stantial constancy. With more drastic hydrolysis we have observed change in pH, this quantity decreasing on the alkaline side, and increasing on the acid side of the stable region. We propose to discuss this in a separate paper dealing with the titration curve of gelatin.

In any case, the higher rates of hydrolysis in the "stable region" exhibited in Northrop's data might be well due to an anion effect of the buffer salts, or to a "neutral salt" effect.<sup>27</sup> It does not appear necessary to assume in this region an internal modification of the gelatin. On the other hand, both Northrop's results at 65° and our own at 50°C. show that the reaction becomes more complicated at high pH values, *i.e.*, in markedly alkaline solution, since there are evidently changes in the slope of the  $\phi_k$ : pH respectively  $\phi_k$ : pH lines. This is in agreement with the observations of Dakin,<sup>28</sup> Lloyd,<sup>29</sup> and Levene,<sup>30</sup> on the racemization of proteins, including gelatin, in strongly alkaline solutions.

In sum, our results point to our value  $\phi_k = \Delta\phi/\Delta t$ , *i.e.*, the rate of change of fluidity, being related to the velocity of hydrolysis  $K$  by an equation of the type

$$\phi_k = a \log K + b$$

where  $a$  and  $b$  are constant. Whether  $a$  and  $b$  are independent of concentration and temperature cannot at present be stated. We have not been able

TABLE X  
Fluidity-Time Curves—De-ashed Gelatin No. 36  
Increasing pH  
50°C. Fluidities

Age in Hours	pH									
	3.4	4.0	4.6	4.9	5.1	5.3	5.6	5.9	6.7	
2	0.149	0.160	0.159	0.173	0.172	0.159	0.158	0.147	0.1415	
4	.172	.171	.166	.176	.175	.1600	.1595	.148	.1425	
6	.196	.182	.173	.180	.178	.1615	.1612	.149	.1432	
8	.220	.193	.180	.183	.180	.1630	.1630	.1502	.1440	
10	.240	.205	.188	.186	.182	.1645	.1650	.1514	.1450	
12	.259	.217	.195	.189	.184	.1660	.1667	.1526	.1460	
14	.275	.229	.202	.192	.186	.1670	.1682	.1540	.1470	
16	.291	.240	.209	.195	.189	.1685	.1700	.1550	.1480	
18	.306	.252	.216	.199	.192	.1695	.1714	.1562	.1490	
20	.321	.263	.223	.202	.194	.1710	.1730	.1574	.1500	
22	.337	.275	.230	.205	.196	.1725	.1747	.1587	.1508	
24	—	.286	.238	.208	.199	.1735	.1760	.1599	.1517	



TABLE X (Continued)  
Fluidity-Time Curves—De-ashed Gelatin No. 36  
Increasing pH  
50°C. Fluidities

Age in Hours	pH							
	7.1	7.5	7.9	8.3	9.0	9.4		
2	.1380	0.1360	0.1370	0.1370	0.1350	0.1320		
4	.1397	.1374	.1390	.1390	.1372	.1375		
6	.1410	.1388	.1408	.1410	.1400	.1425		
8	.1425	.1402	.1425	.1430	.1430	.1480		
10	.1440	.1416	.1444	.1450	.1463	.1530		
12	.1450	.1430	.1462	.1472	.1497	.1580		
14	.1467	.1446	.1480	.1495	.1525	.1630		
16	.1480	.1460	.1500	.1525	.1555	.1680		
18	.1492	.1476	.1518	.1550	.1585	.1740		
20	.1504	.1490	.1537	.1570	.1617	.1790		
22	.1520	.1500	.1554	.1592	.1650	.1820		
24	.1534	.1512	.1570	.1615	.1680	.1847		

to deduce this relation theoretically, and perhaps in view of the uncertain relation of the fluidity (or viscosity) of solvated colloids to the concentration of solid colloid<sup>31</sup> this is not to be expected. But the relation does not seem of improbable type. The viscosity is some function of the striction or immobilization of water. As the large colloid molecules are broken down by hydrolysis, the striction of the water decreases, and the fluidity increases. That over a certain interval the rate of fluidity increase should be proportional to the logarithm of the rate of molecular loosening is a very reasonable conclusion.

These results are in agreement with the view that in such solutions gelatin is molecularly dispersed, at any rate in the sense that every part of the molecule is exposed to the solvent.<sup>32</sup> It may be pointed out that this is in

TABLE XI  
Velocity-pH Curve-Gelatin No. 36. 50°C.

pH	Time in Hours	Increase in Fluidity	% Increase	$\phi_k = \frac{\% \text{ increase}}{\text{Time in Hours}}$
3.4	6	0.071	47.7	7.95
4.0	18	.103	64.4	3.58
4.6	18	.064	40.3	2.23
4.9	18	.0290	16.70	0.930
5.1	18	.0215	12.45	.692
5.3	18	.0120	7.50	.416
5.6	18	.0150	9.50	.524
5.9	18	.0095	6.42	.357
6.7	18	.0094	6.67	.370
7.1	18	.0125	9.08	.502
7.5	18	.0130	9.56	.531
7.9	18	.0165	11.95	.665
8.3	18	.020	14.60	.812
9.0	18	.0270	20.01	1.114
9.4	18	.0340	25.7	1.430

agreement with the conclusions of Simms on the gelatin molecule from a study of the ionic activity of gelatin.<sup>33</sup> He concludes that "The gelatin molecule is large; that the dielectric constant of the medium between these [ionizable] groups is not greatly different from water, and that the free ionizable groups are all functioning and are accessible to the inorganic ions in solution. We conclude that the protein molecule is spongy or arborescent in shape, with molecules of solvent and of other solutes invading the interstices." There are, however, certain recent results which lead to some modification of this picture. The experiments of Gorter and Grendel<sup>34</sup> on the spreading of proteins in water gave a value of about 7.0 Å.U. for the molecular thickness, and our work in this Laboratory<sup>35</sup> has confirmed this result when spreading dilute solutions of gelatin on mercury. This indicates that



if gelatin has an arborescent molecule of branched chains, the arborescence is practically confined to two dimensions, since Simms shows that the distance between ionizable groups in the gelatin molecule must be of the order of 17 to 18 Å.U. or more. Again, from investigations to be published in the second paper of this series, on the anisotropy of gelatin gels, it is concluded that gelatin consists of markedly asymmetrical, flat or elongated, molecules, capable of parallel orientation under stress. It appears very possible, there-

TABLE XIII  
Velocity-pH Curve-De-ashed Gelatin No. 36. 85°C.

pH	Time in Minutes	Increase in Fluidity	% Increase	$\phi_k = \frac{\% \text{ increase}}{\text{Time in Hours}}$
4.9	70	.089	26.88	23.04
5.4	80	.056	18.35	11.26
5.7	70	.034	11.18	9.72
5.9	85	.042	14.91	10.30
6.7	110	.046	18.67	9.97
7.1	55	.031	11.45	12.40
7.7	70	.041	15.83	13.56
9.0	65	.065	24.90	19.90

fore, that the micelles of gelatin sols, at sufficient dilution and temperature, are macromolecules of elongated form but with some degree of branching of the chains, and with a strong tendency to "swarming" and association, which increases with higher concentration and lower temperature.

#### The Relation of Gelatin to Collagen

With gelatin, hydrolysis involves reduction of water-binding power, and consequently decrease of viscosity. On the other hand, in the conversion of collagen to gelatin, also considered a process of hydrolysis, the opposite condition holds. If a suspension of *hide powder* (collagen) is digested at temperatures of 80°C. or upward in dilute acid or alkaline solution, the viscosity will rise at first—particularly if measured at a lower temperature than that of digestion—then pass through a maximum, as the *gelatin* formed is itself broken down by hydrolysis. Now in some earlier studies of the viscosity fall on hydrolysis at 98°-100°C. of a number of commercial gelatins, it was found for a considerable number of these that relatively brief periods of hydrolysis produced a considerable rise of viscosity, then followed by a steady fall. Tables XIV-XVI illustrate this:

If the value of  $\Delta$ , increase of viscosity at 30°C. between 5 mins. and 24 hours be taken with Schröder<sup>30</sup> as an approximate measure of gelatinizing power, it will be seen that a relatively short period of hydrolysis at 100°C. may increase the gelatinizing power of many commercial gelatins enormously, before finally destroying it.

The explanation appears to be that these gelatins, and probably most commercial gelatins, contain a certain amount of incompletely peptized

TABLE XIV

Calfskin Gelatin 6902, 5 percent Hydrolyzed at 98°-100°C. in N/1000 NaOH pH = 5.20 $\eta$ = viscosity at 30°C. after 5 mins. and 24 hours				Gelatin 6902 Hydrolyzed in N/1000 HCl at 98°-100°C. pH 5.07			
Time of Hydrolysis in mins.	$\eta_{75}$	$\eta_{100}$	$\Delta$ = Increase of Viscosity	Time of Hydrolysis in mins.	$\eta_{75}$	$\eta_{100}$	$\Delta$ = Increase of Viscosity
0	4.80	5.01	+0.21	0	5.98	6.10	+0.12
8	5.30	4.97	- .33	5	5.34	5.30	- .04
15	4.15	11.48	+7.33	15	4.32	9.47	+5.15
30	3.79	5.01	+1.22	30	4.60	5.92	+1.32
75	3.14	3.21	+ .07	45	3.80	4.09	+ .29
198	2.46	2.24	- .12	75	3.11	3.10	- .01
318	1.99	2.04	+ .05	130	2.41	2.45	+ .04
				325	1.88	1.87	- .01

TABLE XV

Hide Gelatin (Commercial) 5 percent Hydrolyzed at 98°-100°C. in N/200 NaOH				Hide Gelatin (Commercial) Hydrolyzed at 98°-100°C. in N/4000 HCl			
Time of Hydrolysis in mins.	$\eta_{75}$	$\eta_{100}$	$\Delta$	Time of Hydrolysis in mins.	$\eta_{75}$	$\eta_{100}$	$\Delta$
0	7.21	7.45	+0.24	0	6.82	7.69	+0.87
5	6.93	11.76	+4.83	5	7.10	12.15	+5.05
15	6.70	9.71	+3.01	15	6.45	7.60	+1.15
35	6.09	7.35	+1.26	35	6.03	6.55	+ .52
80	5.48	5.86	+ .38	80	4.95	5.28	+ .33
140	4.64	4.74	+ .10	260	3.45	3.54	+ .09
280	3.78	3.82	+ .04	320	3.29	3.36	+ .07
320	3.44	3.53	+ .11				

TABLE XVI

Ossein Gelatin 5 per cent  
Hydrolyzed at 98°-100°C. in N/1000 NaOH

Time of Hydrolysis in mins.	$\eta_{75}$	$\eta_{100}$	$\Delta$
0	4.38	4.48	+ 0.10
6	5.51	5.82	+ .31
15	6.53	24.01	+17.48
30	4.53	9.90	+ 5.37
45	4.16	5.25	+ 1.09
60	4.76	6.40	+ 1.64
95	3.04	3.19	+ .15
285	2.57	2.52	- .05

*collagen* particles. The transformation of these into gelatin on hydrolytic digestion first raises the viscosity and gelatinizing power, when this is overtaken by the destruction of the gelatin.

The theory of gelatin formation which these results, and other work to be described, suggest is the following: We suppose, in agreement with Meyer and Mark's X-ray investigations<sup>27</sup> that the protein *collagen* consists of fibers built up of crystallites composed of primary valence chains of the anhydro-amino-acids—the protein macromolecules. The formation of gelatin consists in the peptization of these fibers, whereby not only the crystallites, but the primary valency chains become disoriented and separated; complexes of these chains, possibly in a partly oriented or smectic ordering bind water by dipole orientation. On this view, the molecules of gelatin are fundamentally identical with those of collagen, the difference being only in the degree of association and orientation. The mutual attraction of these macromolecules, and their water-binding capacity, are reduced as hydrolysis progressively shortens the chains, until ultimately only a mixture of amino-acids is left.

#### References

- <sup>1</sup> Davis and Oakes: *J. Am. Chem. Soc.*, 44, 464 (1922).
- <sup>2</sup> R. H. Bogue: *J. Am. Chem. Soc.*, 44, 1343 (1922).
- <sup>3</sup> Sheppard, Elliott, and Sweet: *Trans. Faraday Soc.*, 19, 261 (1923).
- <sup>4</sup> Cf. *Ind. Eng. Chem. (Analytical Edition)*, 1, 56 (1929).
- <sup>5</sup> Manning: *Biochem. J.*, 18, 1085 (1924).
- <sup>6</sup> J. Loeb: *J. Gen. Physiol.*, 3, 827 (1921); 4, 73, 97, 351 (1921-3).
- <sup>7</sup> Cf. Bogue: *loc. cit.*
- <sup>8</sup> Sheppard: *J. Phys. Chem.*, 29, 1224 (1925).
- <sup>9</sup> R. H. Bogue: *J. Am. Chem. Soc.*, 44, 1343 (1922).
- <sup>10</sup> Davis and Oakes: *loc. cit.*
- <sup>11</sup> H. Freundlich and Neukircher: *Kolloid-Z.*, 38, 180 (1920).
- <sup>12</sup> Loebel: *J. Phys. Chem.*, 32, 763 (1928).
- <sup>13</sup> Davis and Salisbury: *Ind. Eng. Chem.*, 20, 829 (1928).
- <sup>14</sup> Cf. E. Hatschek: "The Viscosity of Liquids, 120 (1928).
- <sup>15</sup> E. Hatschek: "The Viscosity of Liquids," 200 (1928).
- <sup>16</sup> Kunits: *J. Gen. Physiol.*, 12, 289 (1929).
- <sup>17</sup> Kunits and Northrop: *J. Gen. Physiol.*, 12, 379 (1929).
- <sup>18</sup> Briefer and Cohen: *Ind. Eng. Chem.*, 19, 252 (1927).
- <sup>19</sup> Cf. von Schröder: *Z. physik. Chem.*, 45, 75 (1903).
- <sup>20</sup> Parsons and Sturgess: *J. Bacteriology*, 11, 177 (1926); Parsons, Drake and Sturgess: *J. Am. Chem. Soc.*, 51, 166 (1929).
- <sup>21</sup> Or pseudo-viscosity.
- <sup>22</sup> Johlin: *J. Phys. Chem.*, 29, 271 (1925).
- <sup>23</sup> Northrop: *J. Gen. Physiol.*, 3, 715 (1921).
- <sup>24</sup> A. von Skrabal: *Z. Elektrochemie*, 33, 322 (1927).
- <sup>25</sup> H. Hudson: *J. Am. Chem. Soc.*, 29, 1571 (1907).
- <sup>26</sup> Northrop: *loc. cit.*
- <sup>27</sup> Cf. H. M. Dawson: *J. Chem. Soc.*, 107, 1422 (1927).
- <sup>28</sup> H. Dakin: *J. Biol. Chem.*, 13, 357 (1912-13); H. Dakin and H. Dudley: 13, 263 (1915); H. Dakin and H. Dale: *Biochem. J.*, 13, 248 (1919).
- <sup>29</sup> D. J. Lloyd: *Biochem. J.*, 14, 154 (1920).
- <sup>30</sup> Levene et al.: *J. Biol. Chem.*, 63, 661 (1925); 68, 287 (1926); 74, 715 (1927).
- <sup>31</sup> E. Hatschek: *op. cit.*
- <sup>32</sup> S. E. Sheppard: *Nature*, 107, 73 (1921); S. E. Sheppard and S. S. Sweet: *J. Am. Chem. Soc.*, 44, 2797 (1922).
- <sup>33</sup> Simms: *J. Gen. Physiol.*, 11, 629 (1928).
- <sup>34</sup> Gorter and Grendel: *Trans. Faraday Soc.*, 22, 477 (1926).
- <sup>35</sup> S. E. Sheppard and R. L. Keenan: *Nature*, 121, 982 (1928), Sheppard, Keenan and Niets: *Ind. Eng. Chem.*, 21, 126 (1929).
- <sup>36</sup> von Schroeder: *loc. cit.*: 21, 126 (1929).
- <sup>37</sup> K. Meyer and H. Mark: *Ber.*, 61, 693 (1928).

April, 1929  
Rochester, N. Y.

46-114

THE EMULSIFYING POWERS OF BENTONITE AND ALLIED  
CLAYS, AND OF CLAYS DERIVED FROM THESE BY  
BASE EXCHANGE AND BY HYDROLYSIS

BY R. M. WOODMAN AND E. MCKENZIE TAYLOR

In a previous paper of this series<sup>1</sup> the character and properties of bentonite were discussed, and it was demonstrated to consist mainly of sodium clay. Thus its suspension in water yielded free sodium hydroxide by hydrolysis; it will be shown here, among other things, that the sodium can be replaced by other metals by the process known as base exchange, or by hydrogen as a result of hydrolysis.

A 7 percent. aqueous bentonite suspension was shown to be an efficient emulsifying medium for many oils and non-aqueous liquids, but one result was rather singular: bentonite was found to be capable of promoting both types of emulsion with cresylic acid and water.<sup>1</sup> Such a result warrants further investigation, as it might have an important bearing on theories concerning the mechanism of emulsification, "as it is at present understood that a given emulsifying agent only promotes *one* type of emulsion with any two given liquids to be emulsified."<sup>2</sup> Moreover Weston<sup>3</sup> states that "colloidal clay" is capable of forming the dual types with (fixed) oils and water; no details as to the type of clay under experiment were given, the term "colloidal clay" evidently being thought sufficient. The present work is concerned mainly with attempts to cause specified clay-containing substances to promote the dual types of emulsions with water and fixed oils.

The character, properties, modes of preparation (where necessary) and occurrence of the clay-containing substances (usually designated somewhat broadly in emulsion literature as "colloidal clays" or "clays") are discussed in their separate sections.<sup>4</sup>

<sup>1</sup> Woodman and McK. Taylor: J. Soc. Chem. Ind., 48, 121T (1929).

<sup>2</sup> Clayton: "Emulsions and Their Technical Treatment," 31 (1928).

<sup>3</sup> Weston: Chem. Age, 4, 604, 638 (1921).

<sup>4</sup> It should be understood that natural clays such as bentonite and the so-called soil clays, usually, (although designated as sodium clays, calcium clays, acid clays, etc., in virtue of replaceable sodium, calcium or hydrogen), contain other replaceable elements besides that specifically mentioned in the name. Thus a natural sodium clay may also contain replaceable calcium, magnesium, hydrogen, etc., being a mixture of aluminosilicates.

In addition to the clay proper of a natural clay, there is commonly contained other material: silt (silica), organic substances such as alkali-soluble humus, free chalk (calcium not replaceable), alumina, iron oxide, etc. Thus a so-called clay is not a true clay, but is a clay-containing substance.

Agriculturally, clay is defined as that portion of a soil which will remain in suspension in a depth of 8.5 cm. of water for 24 hr., (i.e., has particles less than 0.002 mm. in diameter). The fallacy of this definition is at once apparent for, even if coarse non-clay material is sedimented by this process, it is possible that much fine silica, alumina, iron oxide, organic matter, etc., may still be in suspension either because of fineness of division, or because of the protective action exerted by the clay itself and by the organic matter.

299

### Experimental

The method of experiment was as follows: an aqueous suspension of the clay emulsifier, ground to 100 mesh to the inch,<sup>1</sup> was made; in all cases the suspensions, unless specially mentioned to the contrary, were one percent. This comparatively low concentration was adopted because in the previous experiments with bentonite<sup>2</sup> a 7 percent. suspension seemed to yield primarily OW types,<sup>3</sup> which might very probably have been due to the comparatively large amounts of free sodium hydroxide (produced by the hydrolysis of so much bentonite) favouring this type. Thus it is conceivable that, in a one percent. aqueous suspension of, say, a fully-saturated sodium clay, the whole of the replaceable sodium is present in solution as the result of hydrolysis in the form of sodium hydroxide a few minutes after making; removal of the hydroxide, *e.g.*, by chemical interaction with the non-aqueous liquid component of the emulsion system, should then allow the residue of the clay—variously styled a “completely-unsaturated,” “hydrogen” or “acid” clay, and often supposed to be chemically inert—to exert its emulsifying action alone, and a WO type might result. It will be seen later that these “inert” clay residues are possibly very chemically active in certain emulsion systems, even though a true acid clay be obtained by removal of all replaceable metals and replacement by hydrogen.

The aim was to make the dual types of emulsion in a given system by *any* means. For this reason the phase-volume ratios employed were altered greatly, as a certain preponderance of a given phase tends to make that phase the continuous one if dual types are at all possible.<sup>4</sup> Different mechanical treatments during preparation were also employed, as mechanical treatment has often a great effect, especially if the phase-volume ratio selected happen to be that common to both types.<sup>4</sup> Standing various emulsions, followed by reshaking of different kinds, was also employed as a possible artifice for obtaining the dual types.<sup>4</sup>

The oils employed were: 1, oleic acid (pure “frozen out”); 2, linseed oil (B. D. H. *Oleum Lini Opt.*, guaranteed in accordance with the B. P. (1914), a two year old sample kept in a blue bottle and possessing an acid value 0.73 in terms of percent. of oleic acid<sup>5</sup>); 3, the same linseed oil plus free oleic acid (labelled hereafter “acid” linseed oil), so that the acid value was 5.8 percent. oleic acid<sup>5</sup>; 4, olive oil, (a two year old sample stored in a brown bottle, possessed of an acid value 1.20 percent. oleic acid<sup>5</sup>, and labelled “B. D. H.

<sup>1</sup> This, therefore, includes particles much greater than those of clays.

<sup>2</sup> Woodman and McK. Taylor: *loc. cit.*

<sup>3</sup> OW means, throughout, the oil (or non-aqueous liquid)-in-water type; WO the reverse.

<sup>4</sup> Woodman: *J. Phys. Chem.*, 30, 658 (1926); 33, 88 (1929); Woodman and Gallagher: *ibid.*, 33, 1094 (1929); Woodman: *J. Pomol. Hort. Sci.*, 4, 184 (1925). It has been found that the age of the emulsifying medium, and of an emulsion which is to be re-shaken, often influence the type formed by subsequent shaking. In these papers the influence of the relative densities of the phases on the character of the cream, and the connection between character, amount of cream and emulsion type are fully discussed.

<sup>5</sup> Fryer and Weston: “Oils, Fats and Waxes,” 2, 125 (1920).



*Oleum Olivae*, 'Cream'," guaranteed genuine olive oil; 5, B. D. H. liquefied phenol; 6, B. D. H. cresol (mixed isomers or cresylic acid), guaranteed in accordance with the *B. P.* (1914); 7, hexalin (*cyclo-hexanol*); 8, methyl-hexalin; and, 9, B. D. H. petroleum ether, boiling range 100-120°C., guaranteed to conform to the standards of purity given in "The B. D. H. Book of A. R. Standards." This last oil was used as a kind of control which should indicate the type of emulsion actually favoured by the emulsifier, for the petroleum ether was "inert" and neutral, whilst it is conceivable that the free sodium and calcium hydroxides derivable from certain clays by hydrolysis with water might react with free fatty acids and phenols.

The suspensions and the oils were pipetted into 50 c.c. cylinders (the less dense phase slowly and carefully on to the other<sup>1</sup>), and the type of emulsion formed was judged by appearance, drop tests and observations on the character and quantity of the cream; the results are given in the tables under the respective sections, the times indicating in every case the age of the suspension used in making, or on re-shaking, an emulsion<sup>1</sup>.

In previous experiments two methods of preparation were chiefly used:<sup>1</sup> 1, immediate vigorous or vigorous intermittent shaking (labelled hereafter IVS), and, 2, gentle partial rotation (equivalent to *very* gentle, "languid" shaking followed by vigorous shaking), labelled henceforth GPR. The vigorous shaking was from the elbow down, the elbow acting more or less as the pivot on which the lower portion of the arm was swung for the shake. A third method of shaking was also employed in the present experiments; this was immediate and vigorous long arm shaking (labelled LAS) and consisted of vigorous and continuous long shakes, the whole arm being kept stiff and swung as freely as possible from the shoulder. This third method was adopted as a result of accidental observations; had it been used before it might have been responsible for an extension in the ranges of phase-volume ratios over which dual types were possible in certain systems.<sup>1</sup>

#### Notes, Results and Discussions: Preparation and Properties of Clays used

The abbreviations employed in the tables are as follows: OW = oil-in-water, and WO = water-in-oil, types of emulsion; FO = free or unemulsified oil in an OW type, and FW = free or unemulsified water in a WO type; P = perfect; S = stable; U = unstable; SU = slightly unstable; VU = very unstable; CG = coarse-grained; IVS, GPR and LAS represent the methods of shaking discussed previously in the text (the third method was not used throughout as it was apparently unnecessary for some systems); s = creaming upwards to give a "supernatant" cream less dense than the excess continuous phase, and u = creaming downwards to give an "undercream" denser than the excess continuous phase<sup>1</sup>; the columns of Table I are numbered so that headings in subsequent tables can be given briefly by reference to these numbers.

<sup>1</sup> Woodman: loc. cit.

TABLE I

1 No. of Emulsion	2 Initial Emulsi- fying Medium	3 Age of Suspension in Hr. at Time of Treatment	4 Oil	5 C.C. of Oil	6 C.C. of Suspension	7 Treatment given to Liquid Phases or to Aged Emulsions	8 Type of Cream	9 Type of Emulsion by Eye, Cream- ing and Drop Tests. <sup>1</sup>	10 Remarks
1 2 and 3		18	← Oleic acid. →	5	15	IVS	s	OW	P.S.
		18		5	15	IVS	s	OW	P.S.
		23				IVS	s	OW	No change.
42				IVS	s	OW	do.		
90				IVS	s	OW	do.		
211 <sup>2</sup>				IVS	s	OW	do.		
4		19		15	5	IVS	u	WO	P.S.
5		19		15	5	IVS	- <sup>3</sup>	OW	Concentrated, stiff, non-creaming. <sup>3</sup>
6	1 percent aq. bentonite suspension	23				IVS	- <sup>3</sup>	OW	No change.
		42 <sup>2</sup>				IVS	u	WO	INVERSION.
		19		5	IVS	u	WO	P.S.	
7		42			IVS	u	WO	No change.	
		90			IVS	u	WO	do.	
		19		10	IVS	s	OW	P.S.	
		45 <sup>2</sup>			IVS	s	OW	No change.	
		90 <sup>2</sup>			IVS	s	OW	do.	

TABLE I (Continued)

1 No. of Emulsion	2 Initial Emulsifying Medium	3 Age of Suspension in Hr. at Time of Treatment	4 Oil	5 C.C. of Oil	6 C.C. of Suspension	7 Treatment given to Liquid Phases or to Aged Emulsions	8 Type of Cream	9 Type of Emulsion by Eye, Creaming and Drop Tests <sup>1</sup>	10 Remarks
8	1 percent. aq. bentonite suspension	211 <sup>2</sup>	Oleic acid.	10	10	IVS	s	OW	do.
		715 <sup>2</sup>				IVS	s	OW	do.
		19				GPR	s	OW	P.S.
		45 <sup>2</sup>				GPR	s	OW	No change.
		90 <sup>2</sup>				GPR	s	OW	do.
		211 <sup>2</sup>				GPR	s	OW	do.
9		715 <sup>2</sup>				GPR	s	OW	do.
		24				IVS	s	OW	P.S.
		43 <sup>2</sup>				Alternate	u	WO	INVERSION.
						IVS and GPR			
10		25				LAS	s	OW	P.S.
		43 <sup>2</sup>				Alternate	u	WO	INVERSION.
11		25				IVS and GPR	u	WO	P.S.
							GPR	u	WO

<sup>1</sup> When doing drop tests, the thoroughly mixed emulsion was usually sampled, so that the phase-volume ratio was not altered. In some duplicates, and where re-shaking was intended, many of the emulsions were judged by eye and by type and by volume of cream.

<sup>2</sup> Traces of free oil on the surfaces by these times.

<sup>3</sup> No creaming when the dispersed phase is more than 74% of the whole emulsion (Woodman: loc. cit.).

TABLE II

Major portion stable for at least 45 min.

1	2	3	4	5	6	7	8	9	10
1	← 1 percent. aq. bentonite suspension →								
12		91	← cressyllo →	5	15	IVS	u	OW	FO.
13		91	← acid →	15	5	IVS	—	WO	FW.
14		91		10	10	GPR	—	OW	FO.
15		91		10	10	LAS	—	OW	FO.
16		96	← lique- →	5	15	IVS	u	OW	FO.
17		96	← phe- nol →	15	5	IVS	—	WO	U.
18		115	← Hex- alin →	5	15	IVS	—	OW	FO.VU
19		115		15	5	IVS	—	WO	CG.VU.
20		119	← Methyl- hex- alin →	5	15	IVS	s	OW	P.S.
21		119		15	5	IVS	—	WO?	See text.
22		139	← linseed oil →	5	15	IVS	s	OW	P.S.
23		139		15	5	IVS	u	WO	P.S.
24		139		10	10	IVS	s	OW	P.U.
25		143				GPR	s	OW	No change.
		140		10	10	GPR	s	OW	P.U.
		143				IVS	s	OW	No change.
26		141	← →	15	5	LAS	—	OW?	See text.

TABLE II (Continued)

1	2	3	4	5	6	7	8	9	10
27	1 percent. aq. bentonite suspension	141	linseed oil	15	5	LAS	u	WO	P.S. INVERSION?
28		141	linseed oil	15	5	GPR	u	WO	P.S.
		141				LAS	—	OW?	See text.
		141				shake.	u	WO	P.S. INVERSION?
29		186	"Acid" linseed oil	15	5	LAS	—	OW	P.S. Staff non-creaming 75% oil.
30		186.5	"Acid" linseed oil	15	5	IVS	u	WO	P.S. INVERSION.
31		186	"Acid" linseed oil	10	10	GPR	u	WO	P.S.
		186	"Acid" linseed oil			GPR	s	OW	P.SU. See text.
32		524	olive oil	5	15	IVS	s	OW	P.S.
33		524	olive oil	15	5	GPR	u	WO	P.S.
34		336	Petroleum ether	15	5	IVS			No emulsion formed by hand-shaking.
35		336	Petroleum ether	15	5	GPR			do.
36		337	Petroleum ether	15	10	IVS			Made by the "mayonnaise" system; all have FO. The final emulsion has 77.7% oil present; it is U, but portions last at least 24 hr.
				+5		IVS	—	OW	
				+5		IVS	—	OW	
				+5		IVS	—	OW	
				+5		IVS	—	OW	

*Bentonite and Derived Clays:*

**Bentonite:** The composition, character and properties of this substance were investigated previously.<sup>1</sup> The clay portion of bentonite (about 80 per cent.<sup>2</sup>), mainly consists of sodium clay; calcium clay is also present, and, without doubt, hydrogen clay as a result of hydrolysis. By submitting the bentonite to the action of salt solutions it is possible to produce saturated clays with only one replaceable base present. It is also possible to produce a completely-unsaturated clay (*i. e.*, an acid or hydrogen clay) by the complete hydrolysis of the sodium and calcium clays in the bentonite. Results<sup>3</sup> illustrating the use of bentonite as an emulsifier are given in Tables I and II.

These tables demonstrate clearly that both types of emulsions are possible in various systems when bentonite is the emulsifier.

In those systems where the common phase-volume ratio was sought, it was found to be 15/5 in favour of the oils (oleic acid, linseed and "acid" linseed oils), dual types being possible here according to the mechanical preparation given; LAS (the most vigorous shaking possible by hand) yielding the OW type (results 10, 26, 28 and 29), GPR (the gentlest treatment) giving the WO type (results 11, 27 and 30) and IVS (intermediate mechanical treatment) giving both types apparently fortuitously when tried for oleic acid (4, 5, 6 and 9).

At this common ratio, re-shaking an OW emulsion after standing some time, caused inversion (5, 9, 10, 26, 28 and 29), though the WO, on standing, did not invert by re-shaking (result 6). The re-shaking necessary to cause inversion to the WO type was sometimes quite long (*e.g.*, about 5 min. vigorous shaking for 9 and 10 for oleic acid), and indications were obtained that GPR alternating with vigorous shaking was beneficial (9 and 10), just as it was the surest method of preparing the WO type initially at this ratio.

No other phase-volume ratio in the systems just discussed gave dual types,<sup>4</sup> even by inversion on re-shaking after long standing of emulsions (2, 3, 7, 8, 24 and 25).

Points of general application can be illustrated from the oleic acid series. In the first place LAS favoured, at the common ratio, the OW type. This is the reverse of the behaviour noted in the system water-gelatine-cresylic acid (or pure cresols), where GPR favoured this type<sup>5</sup>. Moreover the inversion on re-shaking an aged emulsion was from OW to WO, again different from the

<sup>1</sup> Woodman and McK. Taylor: *loc. cit.*

<sup>2</sup> Twenhofel: "Treatise on Sedimentation," 206 (1926).

<sup>3</sup> OW emulsions with sodium clay as the main emulsifier were invariably found to be much slower-creaming than those made with other clay emulsifiers. Suspensions of sodium clay were also slow to settle ("deflocculated") compared with suspensions of other clays, and were much harder to make, owing to a tendency to clog together in masses impermeable to water.

<sup>4</sup> It should be perfectly understood that a phase-volume ratio yielding both types is not a definite *point*, but more probably one of the arbitrarily chosen ratios which happens to be included in a *range* of ratios giving the two types; it is quite likely that ratios a little to either side of that discovered might show this phenomenon. (Two comparatively widely-separated common ratios have been discovered in another system).

<sup>5</sup> Woodman: *loc. cit.*; Woodman and Gallagher: *loc. cit.*

previous system<sup>1</sup>. These two observations were soon found to be of general application throughout the whole of the present experiments, and the first leads to a rule which holds for every system examined here, and, in fact, for all systems yielding dual types examined in this respect excepting that of water-potassium oleate-hexalin (and, possibly, methyl-hexalin)<sup>2</sup>: the most vigorous treatment (LAS, and, in general, IVS), predisposes to an OW type, and the gentlest treatment (GPR *etc.*) to a WO type, if the oil is less dense than the aqueous phase, and *vice-versa*. The caution should be added that this rule was not tested for the phenols with clay emulsifiers, where common ratios were not sought.

The rule was true for fixed oils and fatty acids, however, and considerably eased the experimental work necessary to prove the existence of dual types in these systems and to fix the common ratio: when determining whether a system would yield dual types, a phase-volume ratio well in favour of a particular type was chosen and treatment favouring that type was given, in accordance with the rule; similar treatment, *mutatis mutandis*, favoured the opposite type—if it existed—in the system.

If the system gave two types, the following method was found expedient for fixing the phase volume ratio common to both types, saving both time and materials: a ratio was chosen, say 10/10, and the phases subjected to GPR treatment, which, according to the above rule, in the present systems favoured the WO type. If the emulsion formed were WO, then the next convenient ratio in favour of the aqueous phase was chosen, and that method of treatment favouring the WO type again given; the process was repeated until that ratio (in favour of the water) which yielded an OW type by treatment predisposing to a WO type was found. This was one of the two limits between which the common ratio lay. The ratio was next altered in favour of the oil, and treatment opposing the WO, and in favour of the OW type, given, until a ratio was similarly found yielding the WO type only; this was the other limit. The two limits were usually close, the intervening ratio or ratios being tested out as the common ratios. If the original emulsion at 10/10 ratio were OW, similar treatment, *mutatis mutandis*, was given; re-shaking emulsions in various manners was also used as a method of fixing the common ratio.

Another point of general interest is that during GPR treatment, whenever the favoured WO type was subsequently formed, the aqueous phase was seen to break up in large part or in whole to distinct small globules in the less dense oil phase in every case; the GPR given in these systems was not, for some reason, necessarily so gentle as in previous systems examined,<sup>3</sup> a much larger arc, more quickly described, apparently being advantageous.

Emulsions 26 and 28 call for special mention; the presence of dual types was amply demonstrated in the system water-bentonite-linseed oil, but these

<sup>1</sup> Woodman: *loc. cit.*; Woodman and Gallagher: *loc. cit.*

<sup>2</sup> Woodman: *J. Phys. Chem.*, 33, 88 (1929).

<sup>3</sup> Woodman: *loc. cit.*

two might be at the common ratio. They were formed by LAS with absolutely no discontinuity in the shaking (about 10 shakes), as even one vigorous shake immediately afterwards caused the WO type (result 28). Drop tests in water could not be relied on to fix the type: the drops formed small irregularly-shaped globules (indicating WO, but of a somewhat yellowish linseed oil colour, and not large, well-shaped opaque globules, similar to the true WO drops in water). In addition, these globules creamed upwards in the water in which the drop test was done, the "cream" being a mass of small globules compressed together, unlike a true cream. In view of the fact that GPR at this ratio gave perfect WO types (result 27) and that re-shaking 26 and 28 caused the WO emulsion, it is obvious that this ratio, if not common to both types, is very near the common ratio; probably the difficulty of emulsifying 75% of oil (without adopting the "mayonnaise" system)<sup>1</sup> prevented the formation of a true OW type, the most vigorous shaking by hand<sup>2</sup> possibly partially forming the emulsions only.

No. 21 (water-in-methyl-hexalin) was also a doubtful case; flocculent stringy masses were observed, which settled downwards. Addition of water to the emulsion caused cracking of these masses, tending to prove that the water was dispersed as irregular masses, addition of free dispersed phase favouring de-emulsification.<sup>3</sup>

In an investigation on the use of finely-divided solids as emulsifiers made by Bechold, Dede and Reiner,<sup>4</sup> "clay" was experimented on as an "inert" solid emulsifier (presumably), and grain size and quantity of "clay" were given as the features influencing the powers of "clay" as an emulsifier (to give one type only, the OW). Again, a North African argillaceous earth<sup>5</sup> is quoted as an emulsifier which can replace soap in the emulsification of oils, the inertness of clay as an emulsifier being therefore stressed once more. This is no doubt correct for the mineral oils they used, though the present results, demonstrating that clays are not inert solid emulsifiers merely, but can undergo hydrolysis (to give sodium hydroxide and calcium hydroxide), and other chemical changes (see later), according to the type of clay utilized, should materially modify even this.

The present results are in accord with Weston's,<sup>6</sup> for his "colloidal clay" (the only particular mentioned being that it came from Messrs. Catalpo, Ltd.,) gave dual types with water and various fixed oils. Weston gave no explanation of these strange results, and Clayton,<sup>7</sup> obviously perplexed by Weston's results, states that one emulsifier cannot form both types of emulsions with any two given liquids to be emulsified.

<sup>1</sup> Woodman: J. Pomol. Hort. Sci., 4, 95 (1925).

<sup>2</sup> In view of the marked differences in results obtained by the three methods of shaking, it is probable that a more powerful man (possibly with a longer arm) than the experimenter concerned might have effected emulsification in these two instances.

<sup>3</sup> Stirling: J. Inst. Petrol. Tech., 6, 382 (1920); Clayton: loc. cit., p. 212.

<sup>4</sup> Bechold, Dede and Reiner: Kolloid-Z., 28, 6 (1921).

<sup>5</sup> Pharm J.: 6, 1228 (1898). Quoted from Clayton: loc. cit., p. 28.

<sup>6</sup> Weston: loc. cit.

<sup>7</sup> Clayton: loc. cit., 31 (1928).



If clays are regarded not as inert solid emulsifiers but as compounds capable of undergoing a diversity of chemical reactions, experimental data can be brought into accord with the usual theory of emulsifiers as enunciated by Clayton. Moreover a successful explanation for these systems would give hope of similar explanations for other systems where great doubt and perplexity now exist.<sup>1</sup>

As a tentative explanation of the results of Tables I and II, it can be suggested that the bentonite, containing most of its clay as sodium clay, gives, by hydrolysis, some or all of the free sodium hydroxide possible by the action of water. The emulsifier is, therefore, liable to change, and hence alternative emulsifiers are possible in the systems, providing Clayton's contention with weight at the start.

The hydroxide then combines with the oleic acid and the free fatty acids of the fixed oils, (or the phenols), to form sodium soaps (or phenolates),<sup>2</sup> and the sodium soaps thus formed act, either alone or in conjunction with other emulsifiers present, as oil-in-water emulsifiers for the oleic acid and for the fixed oils (just as alkalies emulsify fixed oil because of soap formation with the free fatty acid impurities).<sup>3</sup>

The bentonite possessed 69.9 milligram equivalents of replaceable sodium per 100 gm. of material;<sup>4</sup> calculations of the sodium hydroxide obtainable by hydrolysis from 1 c.c. of a 1% suspension demonstrate that in every experiment tried there was a *large excess* of free fatty acid after conversion of the whole of the hydroxide possible to sodium soap, even in the case of the linseed oil, which possessed the lowest acid value, 0.73% "oleic acid."

Weight is given to the above notion that the fixed oils are wholly or in part emulsified to OW types in virtue of their free fatty acid content by the facts that, at the common ratio 15/5 in favour of the oils where dual types are possible, the oleic acid and the "acid" linseed oil gave *definite* OW types easily (5, 9, 10 and 29), whilst the linseed oil of low acid value gave *indefinite* results (26 and 28, see previous discussion on these). These results tend to prove the desirability of a great acid value, although theoretically there is already a large excess of free acid in the linseed oil itself.<sup>5</sup>

But the systems also yield WO types: it will be noticed that bentonite contains calcium clay, having a replaceable calcium value of 23.9 milligram equivalents per 100 gm. of bentonite;<sup>6</sup> this calcium clay yields calcium hydroxide by hydrolysis in water (see preparation of calcium-saturated bentonite later), and hence it is possible for water-insoluble soaps to be formed with part of the oleic acid (or the excess fatty acid of the oils), these soaps then

<sup>1</sup> Seifriz: J. Phys. Chem., 29, 834 (1925).

<sup>2</sup> No data were known concerning the part played by phenolates in emulsification, and hence the argument is mainly developed from the sodium soap side.

<sup>3</sup> Donnan: Z. physik. Chem., 31, 42 (1899).

<sup>4</sup> Woodman and McK. Taylor: loc. cit.

<sup>5</sup> Emulsion 31 also illustrates this; it was much stabler than the corresponding emulsions for linseed oil at this ratio (24 and 25), as was shown by standing the emulsions side by side for a period of a week.

<sup>6</sup> Woodman and McK. Taylor: loc. cit.

acting as WO emulsifiers.<sup>1</sup> An excess of suspension in the chosen ratio should favour water-soluble sodium soaps and consequently OW types (less free fatty acid then present, greater smashing action of the aqueous phase, and, though the replaceable sodium and calcium are always present in the suspension in the ratio 3/1, a much greater *absolute* difference in the amount of sodium and calcium soaps present, which last fact is probably of great importance); excess of oil in the chosen ratio should similarly favour oil-soluble soaps and WO types.

At the phase-volume ratio common to both types an equilibrium of the opposing soap emulsifiers can be assumed, and the methods of shaking employed will entail striking differences. Gentle treatment (*e.g.*, GPR for a minute or so, *etc.*) should first favour the formation of all the sodium soaps possible, (without, however, attempting to utilize them as emulsifiers), and then the formation of calcium soaps, subsequent vigorous shaking giving the WO type at this ratio 15/5 on the oil side. Grounds for this statement are not wanting, for it is known (see later, preparation of calcium-saturated bentonite) that a sodium clay hydrolyses much more quickly in water to give sodium hydroxide than a calcium clay to give calcium hydroxide; moreover, it is likely that hydrolysis of calcium clay does not commence or is not very advanced until all or most of the free sodium hydroxide has been removed. Immediate and very vigorous shaking at the common ratio, of course, would tend to cause utilization of the sodium soaps formed first as emulsifiers at once, and hence OW types would result.

Re-shaking of an aged OW type to a WO type can be explained somewhat similarly: result 5 shows definitely that time must elapse before this change, results 5, 9 and 10 that traces of oil (and, therefore, of free fatty acid as well) are probably necessary, and results 9 and 10 that some gentle treatment is possibly an aid. Taking these facts in conjunction, it seems possible that in the case of OW types the oil is emulsified (and therefore prevented from participating in chemical action) by sodium soaps, and only on ageing of the emulsions accompanied by slight cracking to produce free oil (free fatty acid) is the formation—aided, as seen, by gentle treatment—of that amount of calcium soaps necessary to accomplish inversion brought about by combination of free fatty acid and the calcium hydroxide obtained as a result of hydrolysis. The *immediate* re-shaking to WO types at this ratio for linseed oil (26 and 28), is linked up with this: here it has been assumed (see previously) that complete OW emulsification has not occurred; hence the system is not nearly so viscous as a perfect 75 percent. OW emulsion, and free oil is present. Consequently one re-shake allows thorough contact of the oil and the calcium hydroxide which has developed, giving the WO type. The long shaking sometimes necessary to cause inversion, and the favourable influences of gentle treatment, are no doubt due to the fact that the stiffness of the usual 75 percent. OW types (practically semi-solid masses) prevents

<sup>1</sup> With phenols *etc.*, calcium phenolates *etc.* may be formed; these—presumably insoluble—might tend to be water-in-oil emulsifiers.

contact of calcium hydroxide and the traces of cracked oil, vigorous shaking tending to re-emulsify these traces by sodium soap solution.

So far as it goes, the foregoing hypothesis of the emulsifying action of bentonite seemed quite feasible, but other considerations of great note had to be taken into account. Besides the emulsifiers present by hydrolysis and subsequent chemical action, other emulsifiers were taking part: thus there were the non-clay portions of the bentonite (20 percent.) composed of such substances as fine silt (silica), unaltered feldspars and biotite,<sup>1</sup> etc., and the often supposedly-inert hydrogen clay (completely unsaturated) present to some extent initially in the clay portion, and presumably obtained in increasing amounts by the hydrolysis of the sodium and calcium clay and the utilization of the alkali and calcium hydroxide so formed to give soaps. In addition, the questions as to whether pure hydrogen, sodium and calcium clays acted as one-type emulsifiers, and, if so, which type of emulsion each yielded, or whether the hydrogen clay, perhaps in virtue of wettability and increasing quantity, opposed the emulsifying actions of the sodium or calcium soaps obtained from the sodium or calcium clays by hydrolysis and subsequent chemical action, demanded attention.<sup>2</sup>

To aid in the solution of these questions, completely unsaturated bentonite (the clay portion being all hydrogen clay) was made by hydrolysis, and specimens of sodium-saturated and calcium-saturated bentonite were prepared by base exchange; other natural clays from soils, coal-mines, oil-wells, etc., were also procured and derivatives made. They were tested as emulsifiers for fatty acids and fixed oils, and their properties, preparation (where necessary) and the results of emulsion tests are given later.<sup>3</sup> Before proceeding to these, however, it will be found convenient to review briefly some conclusions made previously with regard to the possible uses of bentonite itself.

In a former paper<sup>4</sup> attention was drawn to the possible uses of bentonite as an emulsifier in the preparation of insecticidal emulsions for plants, and as a water-softener in cases of permanent hardness. The first question was investigated more fully, and it was shown that because of the impermeability to water of bentonite (due to the sodium clay content), the preparation of "smooth" aqueous suspensions of bentonite (and, consequently, of spraying emulsions which would not choke the spray nozzles) should not be left to the actual sprayer, but should be undertaken by spray manufacturers possessed

<sup>1</sup> Twenhofel: loc. cit.

<sup>2</sup> Judging by the results for petroleum ether, and for other oils such as decahydronaphthalene, etc., (loc. cit., footnote 4), which are non-reactive to clays and their breakdown products, so that the clays may then be regarded merely as inert solid emulsifiers, it would seem that clays are OW emulsifiers only. In these petroleum ether experiments, emulsions were made by a "mayonnaise" method, i.e., the emulsions were gradually built up by addition of 5 cc. lots of the oil with emulsification by vigorous shaking between each addition.

<sup>3</sup> In many instances phase volume ratios common to both types of emulsion were not sought. The existence of dual types in a system, however, necessarily presumes such a common ratio.

<sup>4</sup> Woodman and McK. Taylor: loc. cit.

of efficient mixing machinery. Now if an emulsion is to be transported economically, it should contain as much dispersed phase as possible, and such concentrated spraying emulsions, intended for dilution with water by the sprayer at the place of spraying, are called "stock" emulsions.<sup>1</sup>

It was shown<sup>2</sup> that 67 percent. stock emulsions of various oils, including phenols and hydrogenated phenols (other than cresylic acid), oleic acid and fixed oils could be easily made with 7 percent. bentonite suspension, and the use of bentonite was advocated to some extent,<sup>3</sup> though reasons for doubt were already entertained, and further investigation was deemed necessary. The present experiments demonstrate clearly, for 1 percent. bentonite suspensions at least, that the absolutely useless water-in-oil type of emulsion (regarded from the viewpoint of the sprayer<sup>1</sup>) is liable to occur when the concentration of the fatty acid, fixed oil, phenol or hydrogenated phenol reaches about 75 percent of the system.

Even were advantage taken of the possibility of preparing (approximately) 75 percent. emulsions of these oils by very vigorous treatment, the jolting received during subsequent transport would probably cause inversion to the undesirable type of emulsion for spraying; and to reduce the amount of oil (a spray manufacturer usually aims at sending out a non-creaming emulsion, which, therefore, contains more than 75 percent. of oil<sup>1</sup>) would mean uneconomic transport and packing. In the circumstances it would be far better to reserve the use of bentonite as a spray emulsifier for such oils as tetra- and decahydronaphthalene, where 80 percent. emulsions of the correct oil-in-water type could be made<sup>2</sup> because of the non-reactivity of these oils to the products of the hydrolysis of sodium and calcium clays.

The possible utilization of other natural clays than bentonite, and of derivatives of these and of bentonite as spray emulsifiers deserves some attention, and the following preparations and experiments were made for the dual purposes of investigating this and the previously-proposed problems.

*Preparation of bentonite saturated with sodium:* Hissink's method<sup>4</sup> for the determination of replaceable bases was used to prepare the sodium-saturated bentonite. Twenty-five gm. of bentonite, ground to pass the 100 sieve,<sup>5</sup> were suspended in 100 c.c. of normal sodium chloride solution for 24 hr. The suspension was filtered and the residue washed with 400 c.c. of normal sodium chloride solution; the residue was then well washed with 50 percent. aqueous alcohol until free from chlorides.

The object of washing with the 50 percent. alcohol instead of with water was to prevent hydrolysis of the sodium clay (which would have resulted

<sup>1</sup> Woodman: loc. cit.; J. Agric. Sci., 17, 44 (1927); J. Pomol. Hort. Sci., 6, 313 (1928).

<sup>2</sup> Woodman and McK. Taylor: loc. cit.

<sup>3</sup> See also, in this connection, English: J. Economic Entomol., 18, 513 (1925).

<sup>4</sup> Hissink: Internat. Mitt. Bodenkunde, 12, 81 (1922).

<sup>5</sup> All grinding was done out of contact of metals; the products made by base exchange and by hydrolysis were re-ground to 100 mesh previous to making suspensions for emulsification purposes.

in the formation of hydrogen clay), as it had previously been found that sodium clay does not hydrolyse in alcohol of that concentration.<sup>1</sup>

The sodium-saturated bentonite was dried at 30°C.

This sodium-saturated bentonite produced an alkaline solution of suspension in water, and possessed the characteristic properties on a sodium clay. The alkaline reaction of the suspension in water is due to the production of free sodium hydroxide as a result of hydrolysis.<sup>2</sup>

Estimation of replaceable sodium was not done, though, as the sodium bentonite was saturated, it must have been equal to the sum of the replaceable sodium,<sup>3</sup> calcium<sup>3</sup> and hydrogen of the original bentonite sample.

Emulsification results are given in Table III.

*Preparation of calcium-saturated bentonite:* The calcium-saturated bentonite was prepared in a similar manner to the sodium-saturated bentonite, the replacing solution being normal calcium chloride solution. The calcium-saturated bentonite, after being filtered off, was washed with 50 percent alcohol to remove excess of calcium chloride<sup>4</sup> and was then dried at 30°C.

The calcium-saturated bentonite had a pH value<sup>5</sup> of 7.4. Its physical properties contrasted strongly with those of the sodium-saturated bentonite; It did not set to a hard mass, but was granular and also readily permeable to water. On hydrolysis in water it yields a solution of calcium hydroxide and a residue of hydrogen clay; the process of hydrolysis being much slower than that of sodium-saturated bentonite.

The results of emulsion formation with this substance as emulsifier are given in Table III.

*Preparation of completely-unsaturated bentonite:* Bentonite, ground to pass the 100 sieve, was suspended in N/10 hydrochloric acid and the suspension filtered through a porous candle under reduced pressure. The residue was again washed with N/10 hydrochloric acid, the washing being repeated until the filtrate was free from calcium. The residue—an "acid" or hydrogen clay—was then washed with distilled water until the filtrate was free from chloride and was finally dried at 30°C. The pH value of the clay was 2.4.

Emulsion results are given in Table III:

The results for sodium-saturated bentonite as emulsifier are very similar to those for bentonite, a phase-volume ratio common to both types being indicated by the re-shaking experiment 39 at the same ratio 15/5 in favour

<sup>1</sup> McK. Taylor: unpublished data.

<sup>2</sup> McK. Taylor: "Cotton Research Board Fourth Annual Rpt.", (Cairo), 121 (1923).

<sup>3</sup> Woodman and McK. Taylor: loc. cit.; a similar remark also applies to all fully-saturated clays derived by base exchange.

<sup>4</sup> McK. Taylor: Fuel, 6, 359 (1927).

<sup>5</sup> The authors adopted the following method in all cases for determining pH values of clays and soils: 10 gm. of 100 mesh air-dried clay or soil were shaken with 50 c.c. of distilled H<sub>2</sub>O; after leaving 30 min. with occasional shaking the pH of the clearest portion of the suspension was determined colorimetrically.

TABLE III

1	2	3	4	5	6	7	8	9	10
37	1/4	1/2	Oleic Acid	5	15	IVS	s	OW	P.S. Creaming slow as with all sodium clays.
38	1/2	1	Oleic Acid	15	5	GPR	u	WO	Thick paste. See text.
39	1	1	Oleic Acid	15	5	LAS	-	OW	INVERSION immediately.
40	2 1/2	2 1/2	Oil Lin- seed	5	15	IVS	u	OW	P.S.
41	2 1/2	3	Oil Lin- seed	15	5	GPR	s	WO	P.S.
42	3	3	Petroleum Ether	5	15	IVS	u	OW	P.S.
43	3 1/2	3 1/2	Petroleum Ether	15	5	GPR	u	WO	Made by "mayonnaise" system of addition.
44	3 1/2	3 1/2	Petroleum Ether	5	5	IVS	u	OW	Emulsions become stiffer as more oil added.
45	1	1	Oil Lin- seed	+5	15	IVS	s	OW	confirming OW type. Last one is a stiff
46	1	1	Oil Lin- seed	+5	10	IVS	s	OW	paste. Addition of final 5 c.c. of oil with
47	1	1	Oil Lin- seed	+5	10	IVS	u	OW	shaking causes breaking, and get a clear
48 and 49	1 1/2	1 1/2	Oil Lin- seed	+5	10	IVS	u	OW	layer of oil over a very dilute OW emulsion
50	2	2	Oil Lin- seed	10	10	LAS	s	OW	left.
51	2	2	Oil Lin- seed	10	10	IVS	s	OW	P.
52	3	3	Oil Lin- seed	5	15	IVS	s	OW	CG.U. From appearance near common ratio.
53	3	3	Oil Lin- seed	15	5	IVS	u	WO	FW. Not very stable.
54	3	3	Oil Lin- seed	5	15	IVS	u	OW	do.
55	3	3	Oil Lin- seed	15	5	IVS	s	OW	do.
56	3 1/2	4	Oil Lin- seed	5	and 5	GPR and IVS	u	WO	FO. Stiff, non-creaming. (tested by drop
			Oil Lin- seed	+5		IVS		OW	test).
			Oil Lin- seed	+5		IVS		OW	INVERSION. P. Immediate reshaking did
			Oil Lin- seed	+5		IVS		OW	not cause inversion.
			Oil Lin- seed	+5		IVS		OW	Made by "mayonnaise" system of addition.
			Oil Lin- seed	+5		IVS		OW	Emulsions become stiffer as more oil added.
			Oil Lin- seed	+5		IVS		OW	Breaks at last addition to clear oil over thin
			Oil Lin- seed	+5		IVS		OW	OW emulsion.
			Oil Lin- seed	+5		IVS		OW	breaks.

1% aq. suspension of Sodium-saturated bentonite →  
 1% aq. suspension of Calcium-saturated bentonite →

TABLE III (Continued)

1	2	3	4	5	6	7	8	9	10
57	1% aq. suspension of completely-unsaturated bentonite	1 1/2	Oleic Acid	5	15	IVS	s	OW	P.S. IVS after 24 hr. causes no change. P. Becomes CG. Reshaken after 3/4 hr. No change.
58		2		15	5	IVS	u	WO	
59		2		10	10	IVS	s	OW	P.S. No change.
60		24		10	10	IVS	s	OW	
61		5		10	10	GPR	s	OW	P.S. Reshake after 19 hr. and no change.
62		5		10	10	LAS	s	OW	
		5		15	5	GPR	u	WO	P.S. do. P.U. Becomes CG. Reshake after 19 hr. and no change.
63		5		15	5	LAS	u	WO	
64		25		15	10	IVS	s	OW	P.S. CG.
65		25		15	10	GPR	s	OW	
66		20		15	10	LAS	s	OW	do.
		50		15	10	IVS	s	OW	
67		53		5	15	IVS	s	OW	No change.
68		53		15	5	IVS	s	OW	
69		53		15	5	LAS	u	WO	P.S.
70		72		15	5	IVS	u	WO	
71		72		15	5	IVS	s	OW	P.S.
72		72		5	15	IVS	u	OW	
73		72		15	5	IVS	s	OW	P.S.
		72		15	5	IVS	—	OW	
74		72				IVS	u	WO	FO: Must have perfectly continuous shaking. Stiff and non-creaming. INVERSION immediately. Cream breaks slowly.
75		72 1/2		15	5	GPR	u	WO	
		73		15	5	LAS	—	OW	P. Cream breaks slowly. FO: Stiff, non-creaming. Continuous shaking used.
76		73 1/2				IVS	—	OW	
76a		74 1/2		5	15	IVS	u	WO	No change. INVERSION. Undercream breaks slowly. FO.
		75		15	5	IVS	s	OW	
		75		15	5	IVS	s	OW	75% OW emulsion made initially by very long-continued shaking. Even after adding 10 c.c. more oil in two 5 c.c. lots, an OW still resulted. FO. in all three emulsions.
		75		15	5	IVS	—	OW	

LITHO BY THE UNIVERSITY OF CALIFORNIA PRESS, BERKELEY, CALIF.

of the oleic acid.<sup>1</sup> As sodium was the replaceable base present, and as, therefore, no calcium soaps were possible, it was reasonable to assume that sodium bentonite would form simple one-type oil-in-water emulsion systems; this assumption gathered weight from the results for the "inert" oil petroleum ether.<sup>2</sup>

The systems containing oleic acid and fixed oils, however, gave dual types, despite the well-proven fact that sodium soaps, possible in these cases, are known to yield OW types with such oils. The only hypothesis possible at this stage to explain the phenomena was that the completely-unsaturated clay, obtained by full hydrolysis of the sodium-saturated bentonite in water and utilization of the sodium hydroxide so got to form sodium soaps, favoured the WO type.

If the sodium-saturated bentonite were expected to form OW types, calcium-saturated bentonite would be expected, similarly, to give WO types only; and if the completely-unsaturated clay obtained by full hydrolysis and subsequent utilization of the calcium hydroxide so formed to give oil-soluble calcium soaps were a WO emulsifier, as reasoned above, this expectation should be strengthened. "Inert" petroleum ether, however, yielded OW types only, the other oils giving dual types (Table III). It is true that the phase-volume ratio common to both types for oleic acid had shifted from the usual 15/5 in favour of the acid to between 10/10 and 10/5 for this system, but this could be taken to demonstrate the absence of all sodium soaps and the presence of greatly increased amounts of calcium soaps, and affords no solution for the actual occurrence of OW types.

The only explanation possible at this stage was that the completely-unsaturated bentonite—which should be identical with that got similarly from sodium-saturated bentonite—was an emulsifier favouring OW types, a conclusion diametrically opposite to one preceding.

Harmony between these two conclusions was only possible if it were assumed that the hydrogen clay could act as an emulsifier for both types of emulsions, and this was found to occur (Table III), for, though only the OW type was given by "inert" petroleum ether even at 83 percent. of oil, dual types were formed with the other oils, the common ratio in the case of oleic acid being between 15/10 and 15/5 in favour of the acid.

Now completely-unsaturated or hydrogen clays are often thought to be chemically inert to a large degree, pardonably so in view of the fact that they apparently represent the end product of complete hydrolysis. If, however, they are regarded as being chemically inert, so that they act as emulsifiers simply in virtue of grain size and quantity, they should not react with

<sup>1</sup> No. 39 was similar to nos. 26 and 28, 10 shakes with no discontinuity in the shaking being given to form the pasty OW (tested). Practically immediate reshaking caused inversion, as shown in Table III. A duplicate (not given) to 39, evidently inverted during the LAS preparation to the WO type, judging by the change in the *feel* of the cylinder (the WO type is less viscous at this common ratio 15/5 in favour of the oil, and hence the cylinder's contents respond to shaking more).

<sup>2</sup> *I.e.*, "inert" as regards chemical reaction to the products of the hydrolysis and breakdown of clays.



fatty acids, and the results could only be explained by the presumption that one emulsifier could form dual types with water and fatty acids (or fixed oils containing fatty acids). If this were so, then dual types might also be expected with petroleum ether, a result contrary to that found. Hence it was assumed that hydrogen clays are not inert, and evidence of this was gathered from the literature:<sup>1</sup>

Thus Gedroiz<sup>2</sup> stated that when the (clay) complex is saturated with hydrogen ion (*i.e.*, when a completely-unsaturated or hydrogen or "acid" clay is present) its resistance to the decomposing effect of water is lowered, which may result in the disintegration of the anion portion of the complex into its constituent oxides; this is sometimes shown by the accumulation of the free hydrate of alumina in podzol soils;<sup>2,3</sup> moreover, Magistad,<sup>4</sup> by examination of a number of soil solutions from natural soils, showed appreciable quantities of soluble aluminum to be present in the solutions lying *outside* the limits<sup>5</sup> of pH 4.7 and 8.0, and Kelley and Brown<sup>6</sup> found that every neutral or alkaline soil examined gave extracts containing appreciable amounts of silica (as much as 0.1 percent of the soil), so that the stability of the complex ion in every clay is open to question.

The decomposing effect of water on completely-unsaturated clays (especially) afforded a solution to the problem raised in the section on hydrogen bentonite as an emulsifier, for it could be assumed that the soluble aluminum present by this disintegration combined with free fatty acid to give aluminum soaps, which would favour the WO type of emulsion; the OW type would be formed by the clay *itself*, or its breakdown products, silica and alumina (which are OW emulsifiers<sup>7</sup>), in virtue of grain size and quantity present.

*Nile silt containing sodium clay:* The naturally-occurring alkaline soil used in these experiments was obtained from Halq el Gamal, Lower Egypt. The material originally consisted of normal Nile silt, a calcium clay, derived from the igneous rocks of the Abyssinian Plateau. It had been deposited during the Nile flood in that portion of the Nile Delta situated below a six-metre contour. The sub-soil water in this area contains sodium chloride

<sup>1</sup>The present systems differ from others examined minutely in view of the occurrence of dual types (*loc. cit.*) because the emulsifiers are not soluble in either or both phases to any great extent presumably, as the other emulsifiers were, and hence partition of emulsifier cannot be supposed to play a leading role; the explanations given in the present instances raise the hope that other systems will, in the future, be brought strictly into line with the existing emulsion theories.

<sup>2</sup>Gedroiz: "The Theory of the Absorptive Power of Soils," (monograph) (1922); *J. Expl. Agronomy* (1924); see also Tiurin: *Acad. of Sci. of the USSR: Russian Pedological Investigations*, 4 (1927).

<sup>3</sup>Hemmerling: *Rept. 5th. Meeting of Soil Scientists of USSR* (1926).

<sup>4</sup>Magistad: *Soil Science*, 20, 181 (1925). This factor, of course, might directly play an important part in the formation of WO types with alkaline clays of pH value greater than 8.0 (*e.g.* bentonite and sodium-saturated bentonite), the soluble aluminium forming aluminium soaps (see the reasoning following for the formation of dual types with hydrogen clay).

<sup>5</sup>Completely-unsaturated bentonite gives a solution of pH 2.4 (see preparation).

<sup>6</sup>Kelley and Brown: *Univ. of California Publications, Tech. Paper* 15 (1924); see also Joseph and Hancock: *J. Chem. Soc.*, 125, 1888 (1924) for a discussion on the reactivity of clays, including bentonite.

<sup>7</sup>Pickering: *J. Chem. Soc.*, 91, 2001 (1907).

in solution. Owing to the intense evaporation of water from the surface of the soil during the summer months, a crust of sodium chloride forms on the surface of the soil, and, during the subsequent flood period, the salt is washed out of the soil, which then becomes a typical "black alkali" soil because of its sodium clay content. The properties of this soil have been discussed previously.<sup>1</sup>

The soil contained 4.4 percent. of "free" calcium carbonate, and its pH value was 9.8; the following replaceable bases were present: sodium 47.5 and calcium 3.6 milligram equivalents per 100 gm. of soil.

Emulsion data are presented in Table IV.

*Preparation of Nile silt fully saturated with barium:* Barium-saturated Nile silt was prepared from the alkaline Nile silt discussed above by replacement of replaceable sodium, calcium and hydrogen by means of barium from barium chloride solution. The excess barium chloride was removed by washing with 50 percent alcohol. In its physical properties barium clay closely resembled calcium clay, having a granular structure and being permeable to water. It is unsuitable for plant growth, however, for though germination is normal the plants are dwarfed.

Emulsification results are given in Table IV.

*Calcium clay (London clay from Rettendon, Essex, England):* As an example of a calcium clay, a subsoil of the London clay at Rettendon was selected. It contained no calcium carbonate; its pH value was 7.2 and it contained 16.5 milligram equivalents of calcium per 100 gm. of soil, having no replaceable sodium.

Emulsion data are given in Table IV.

*Preparation of completely-unsaturated (hydrogen) clay from Rettendon London clay subsoil:* A hydrogen clay was prepared from the London clay subsoil from Rettendon. The subsoil was suspended in normal ammonium chloride solution for 24 hr. to produce a saturated ammonium clay. The ammonium clay was washed with water, the filtration being carried out by means of a porous candle. On removing the excess of ammonium chloride, the soil became almost impermeable and was alkaline, the ammonium clay behaving similarly to a sodium clay. Continuing the hydrolysis, the alkalinity disappeared, the final pH value of the soil being 4.2. The washing of the ammonium clay was continued until no further ammonia could be detected in the washings by Nessler's solution.

Results illustrating the emulsifying power of this hydrogen clay are given in Table IV.

Table IV demonstrates the fact that with the Nile silt as emulsifier, both types of emulsion were possible with linseed oil and oleic acid; with olive oil, doubtless because of "specificity" of oil,<sup>2</sup> the WO type alone seemed possible, results 81 and 86 most probably signifying non-emulsification, the oil being merely turbid with water. With petroleum ether, (dilute) OW types only were

<sup>1</sup> McK. Taylor: Fuel, 5, 195 (1926).

<sup>2</sup> Woodman and McK. Taylor: loc. cit.

noted; but, despite this fact, Nile silt, though good for the preparation of WO emulsions, was poor as an OW emulsifier even in 5 percent aqueous suspension. In this connection, however, it must be remembered that, in dealing with soil clays, quantities of silt (silica) present as comparatively large particles are probably not particularly effective as emulsifiers, though they favour the OW type. Other substances associated with this clay, such as free chalk, magnetite (typical of Egyptian sediments<sup>1</sup>), etc., also probably masked the OW emulsifying action of the clay through being poor emulsifiers.

The barium-saturated Nile silt was also an unsatisfactory OW emulsifier; the presence of replaceable barium, however, favouring the production of oil-soluble barium soaps by combination of free fatty acid and the barium hydroxide liberated by hydrolysis, would tend to make it worse than Nile silt itself for this purpose.

London clay subsoil in 1 and 5 percent aqueous suspension tended generally to give good WO and poor OW types also; the completely-unsaturated derivative of this subsoil was much more definite in both types of emulsion (Table IV).

*Acid shale forming roof of a coal seam:* This specimen was obtained from the roof of a Tertiary bituminous coal seam at No. 15 mine, Nazira Colliery, Dhanbad, Assam.<sup>2</sup> The pH value of the specimen was 4.2; a determination of replaceable bases gave the following: Calcium, 0.6, sodium, 6.6 milligram equivalents per 100 gm. of shale.

Since the replaceable sodium was in excess of the replaceable calcium it indicated that the clay in the shale had undergone base exchange with solutions of sodium chloride. As the shale was acid, the hydrolysis of the sodium clay must have proceeded to such an extent that the dominant clay type finally present was a hydrogen clay. The specimen consisted, therefore, of hydrogen clay together with small quantities of unhydrolysed sodium and calcium clays.

Emulsion data are given in Table V.

*Lignitic clay:* The specimen of lignitic clay used was from the roof of the lignite seams in Czecho-Slovakia; as with the roofs of other lignite seams, it had not undergone base exchange with sodium salts.<sup>3</sup> It consisted of a mixture of calcium and hydrogen clays, the pH value of the specimen being 6.8; it contained 12.7 milligram equivalents of calcium per 100 gm. of material.

Emulsification results are given in Table V.

*"Cap rock" of oil sands:* The shales forming the cap rocks of oil-bearing strata have been shown to contain large quantities of sodium clay.<sup>4</sup> The clays in these rocks have undergone base exchange with sodium chloride solu-

<sup>1</sup> Mosseri: Bull Inst. d'Egypt, 1, 151 (1919).

<sup>2</sup> McK. Taylor: Paper read at 16th. Indian Science Congress (Madras 1929).

<sup>3</sup> McK. Taylor: Fuel, 7, 227 (1928).

<sup>4</sup> McK. Taylor: J. Inst. Petrol. Tech., 14, 825 (1928); 15, 207 (1929).

TABLE IV

1	2	3	4	5	6	7	8	9	10
77	↑ 1% aq. suspension of Nile silt	1/2	Oleic acid.	5	15	IVS	s	OW	FO. U. Usual slow-creaming of Na clays.
78		1/2	Oleic Linseed Oil.	15	5	GPR	u	WO	P.U. FW soon appears.
79		1	Olive Linseed Oil.	5	15	IVS	s	OW	FO. VU. Slow-creaming.
80		1	Petrol-ether.	15	5	GPR	u	WO	P.
81		3	Oleic Linseed Oil.	5	15	IVS	—	?	See text.
82		3	Oleic Linseed Oil.	15	5	GPR	u	WO	P.
83		3	Petrol-ether.	5	5	IVS	—	OW	Made by the "mayonnaise" system; FO. and CG. Last addition causes cracking to clear layer over thin OW emulsion.
84	↑ 5% aq. suspension of Nile silt	3/4	Oleic Acid Linseed Oil.	5	15	IVS	s	OW	FO. VU.
85	↑ 5% aq. suspension of Nile silt	1/2	Linseed Oil.	5	15	IVS	s	OW	FO. VU.
86	↑ 5% aq. suspension of Nile silt	1/4	Olive Oil.	5	15	IVS	—	?	Similar to 81.
87	↑ 1% aq. suspension of saturated Nile silt	1/4	Oleic Acid Linseed Oil.	5	25	IVS	—	OW?	VU. Breaks in a min.
88	↑ 1% aq. suspension of saturated Nile silt	1/4	Linseed Oil.	15	5	GPR	u	WO	P.U. Cannot judge.
89	↑ 1% aq. suspension of saturated Nile silt	1/4	Petroleum Ether	5	15	IVS	—	?	P.U. Cannot judge.
90	↑ 1% aq. suspension of saturated Nile silt	1 1/2		15	5	GPR	u	WO	P.U. Cannot judge.
91	↑ 1% aq. suspension of saturated Nile silt	1 3/4		5	5	IVS	u	OW	FO. CG. U.

TABLE IV (Continued)

1	2	3	4	5	6	7	8	9	10
92	1% aq. sus- pension of London clay	1/4	Oleic Acid	5	15	IVS	s	OW	CG. VU. Quick-creaming.
93	1% aq. sus- pension of London clay	1/4	Linseed Oil	15	5	GPR	u	WO	P. SU. Cannot judge.
94	1% aq. sus- pension of London clay	1/2	Olive Oil	15	5	IVS	—	WO	P. FO. VU.
95	1% aq. sus- pension of London clay	3/4	Olive Oil	15	5	GPR	u	OW	P. U.
96	1% aq. sus- pension of London clay	1	Oleic Oil	15	5	IVS	s	WO	P. U. Much harder than 93 to make. Had to reshake 3 times.
97	1% aq. sus- pension of London clay	1	Oleic Acid	15	5	GPR	u	WO	U.
98	1% aq. sus- pension of London clay	1 1/4	Linseed Oil	5	15	IVS	s	OW	U.
99	1% aq. sus- pension of London clay	1 1/2	Olive Oil	5	15	IVS	s	OW	U.
100	5% aq. sus- pension of London clay	1	Linseed Oil	5	15	IVS	s	OW	U.
101	5% aq. sus- pension of London clay	.1	Olive Oil	5	15	IVS	s	OW	U.
102	10% aq. sus- pension of London clay	19 1/2	Oleic Acid	5	15	IVS	s	OW	Quick-creaming.
103	10% aq. sus- pension of London clay	19 1/2	Linseed Oil	15	5	GPR	u	WO	P.
104	10% aq. sus- pension of London clay	20	Linseed Oil	5	15	IVS	s	OW	Quick-creaming (curdy).
105	10% aq. sus- pension of London clay	20	Olive Oil	15	5	GPR	u	WO	P.
106	10% aq. sus- pension of London clay	20 1/4	Olive Oil	5	15	IVS	s	OW	Quick-creaming.
107	10% aq. sus- pension of London clay	20 1/4	Olive Oil	15	5	GPR	u	WO	P.

TABLE IV. Emulsifying powers of bentonite and allied clays.

TABLE V

1	2	3	4	5	6	7	8	9	10
108	1% aq. sus- pension of acid shale	1/2	Oleic	5	15	IVS	s	OW?	FO.CG.U. Quasi-emulsion?
109	↑ forming roof of a coal seam	3/4	Acid Linseed	15	5	GPR	u	WO	FW.U.
110		1	Oil	5	15	IVS	s	OW?	Do. to 108
111		1 1/4	Olive	15	5	GPR	u	WO	P.SU.
112		2 3/4	Oil	5	15	IVS	s	OW?	Worse than 108 and 110.
113		3	Oil	15	5	GPR	u	WO	P.
114		1 1/4	Oleic	5	15	IVS	—	no emulsion	See text
115		1 1/4	Acid	15	5	GPR	u	WO	P.U.
116		1/2	Linseed	5	15	IVS	—	No emulsion	See text
117		1/2	Oil	15	5	GPR	u	WO	P.SU.
118		3/4	Olive	5	15	IVS	—	No emulsion	See text.
119		3/4	Oil	15	5	GPR	u	WO	P.U.
120	1% aq. suspension of lignitic clay	1	Petroleum	5	5	IVS		OW	Made by "mayonnaise" system.
	↑		Ether	+5		IVS		OW	Emulsions more viscous the greater the amount of oil. Last one (coarse and thick) breaks on continued shaking to give clear oil over clear water. All FO.CG. See text.
				+5		IVS		OW	
				+5		IVS		OW	

TABLE V (Continued)

1	2	3	4	5	6	7	8	9	10
121		1	Oleic	5	15	IVS	s	OW?	FO. CG. Probably quick-creaming quasi-emulsion.
122		1	Acid Linseed	15	5	GPR	u	WO	P.U.
123		1 1/4		5	15	IVS	s	OW	SU. Slow-creaming (Na clay present.)
124		1 1/4	Oil	15	5	GPR	u	WO	P.SU. More stable than 122.
125		1 1/2	Olive Oil	5	15	IVS	s	OW?	Similar to 121.
126		1 1/2	Oil	15	5	GPR	u	WO	P.U.
127	1% aq. suspension of "Cap rock" of oil sands	2	Petroleum	5	5	IVS	u	OW	Made by the "mayonnaise" system of addition. More viscous as more oil added, thus giving additional proof that emulsions are OW. Last addition causes breaking to clear oil over thin OW emulsion. Definite. Rather curdy.
			Ether	+5		IVS		OW	
				+5		IVS		OW	
				+5		IVS		OW	
				+5		IVS		OW breaks	
128		1/4	Oleic	5	15	IVS	s	OW	Fine-grained and slow-creaming.
129		1/2	Acid Linseed	5	15	IVS	s	OW	
130	5% aq. suspension of "Cap rock" of oil sands	3/4	Oil	5	15	IVS	—	?	Breaks instantaneously.
			Olive Oil						

tions, and some subsequent hydrolysis of the sodium clay has taken place in fresh water.

The specimen used was obtained from the Guapo Field, Trinidad Central Oil Fields, and occurred at a depth of 1485 ft. It was non-calcareous (*i.e.*, had no free chalk), and possessed a pH value of 9.0. It contained some free petroleum, perceptible to the smell, and it was found impossible to estimate replaceable sodium because of the non-wettability by normal aqueous ammonium chloride, the particles clinging together in clusters. This was the case, to some extent, on attempting to make a suspension of the material in water; vigorous shaking, however, caused an even suspension, no doubt because the cap rock acted as an emulsifier (in the presence of sodium hydroxide obtained by hydrolysis in water) for the traces of petroleum causing non-wetting.

Emulsion details are given in Table V.

Much the same as the results obtained for Nile silt and London clay subsoil were those observed for the roof shale of the Nazira Colliery, Assam, and the cap rock of the Guapo oil sands (Table V). The tendency to form the OW type was slight and doubtful, and was in no case similar to the pronounced tendency of bentonite and its derivatives.

This bias in favour of the WO type reached its limit in the case of the lignitic clay, the small clay portion of which consisted of calcium and hydrogen clays. In no instance was the OW type prepared with a fixed oil or with fatty acid, though with petroleum ether this was the sole type; it is, therefore, very probable that this substance acts as a simple one-type emulsifier in most systems, the type yielded in any particular instance depending mainly on the character of the oil.

With the lignitic clay, it was noticed that where non-emulsification occurred (results 114, 116, 118), the particles in the aqueous suspension—even the coarsest—were transferred to, and intermingled with as a kind of "slime," the layer of oil, leaving practically clear water in the underlayer. This was quite different behaviour from that noted with any other clay emulsifier, and evidently denoted preferential wetting by the oil phases, with a tendency, therefore, to yield WO types only. These results seem to demonstrate some analogy between the partition of a *solid* emulsifier and of one soluble (like soaps and gelatine) in one of the liquid phases at least, between the liquids of an emulsion system;<sup>1</sup> an infinite partition of the solid particles takes place in favour of the oils because of the preferential wetting, one-type systems resulting.

Emulsion 120, that with petroleum ether (OW), was also peculiar on adding sufficient oil to cause cracking, for the solid matter gathered as a thick layer at the interface of the liquids, which were *both* quite clear (in all other cases the breakdown of the petroleum ether emulsions by addition of excess oil resulted in a clear layer of oil over a thin OW emulsion, the aqueous medium also retaining the suspended matter).

<sup>1</sup> Woodman: *loc. cit.*



The results of Tables IV and V demonstrate that the clays tested last were of no use whatsoever in the preparation of concentrated stock emulsions of the oils experimented on for spraying. With bentonite and its derivatives (Tables I-III) moderately concentrated and stable OW emulsions were at least possible, and risks of inversion were the main drawback; here, even dilute OW emulsions cannot be prepared in a stable form, the main tendency being to form the WO type, which is undesirable from a spraying standpoint. Thus a large number of clays from diverse sources and of diverse kinds was entirely unsuitable in the preparation of spraying emulsions containing oils which might interact chemically with products obtained from clays either by hydrolysis or by the cleavage of the clay complex.

#### Summary

The contention of Weston (*loc. cit.*) that a clay can promote both types of emulsion in certain cases has been proved correct.

Clay-containing substances of diverse kinds and from diverse sources, and derivatives prepared from these by base exchange and by hydrolysis, have been demonstrated, in the main, to give the dual types of emulsions.

Clays give dual types of emulsions with fatty acids, fixed oils containing free fatty acids, and with phenols and hydrogenated phenols. The hypothesis advanced is that this is due to chemical interaction of the fatty acids, *etc.*, with sodium and calcium hydroxides, *etc.* obtained by hydrolysis of the clay when in aqueous suspension, or with breakdown products of the clay itself. The original emulsifier thus undergoes change and soaps are introduced into the system.

The changes taking place in the original emulsifier and the different emulsifiers present can easily be made to afford sufficient explanation of the fact that dual types are formed; the clays, *as such*, are not responsible, and the results are brought strictly into line with the usual emulsion theory as enunciated by Clayton (*loc. cit.*) that one emulsifier cannot promote two types of emulsion with any two given liquids to be emulsified.

Clays of all kinds are unsuitable as emulsifiers in the preparation of spraying emulsions containing free fatty acids, fixed oils and phenols because of the liability of the formation of the undesirable water-in-oil type. Even if moderately concentrated oil-in-water stock emulsions are possible as with bentonite and its derivatives, jolting received during subsequent transit would probably cause inversion. The results of this extended study of clays modify to some extent the conclusions to be drawn from the previous study of bentonite.

An example is given—"lignitic clay"—where water-in-oil emulsions only are possible with fatty acids and fixed oils, and where the suspended material is completely withdrawn from the aqueous phase.

Horticultural Research Station,  
Cambridge University,  
England.  
June 17, 1929.

## DETERMINATION OF THE CHARGE ON A COLLOID AND THE MECHANISM OF ITS COAGULATION

BY M. N. CHAKRAVARTI, S. GHOSH AND N. R. DHAR

Perrin,<sup>1</sup> Hardy,<sup>2</sup> Lottermoser,<sup>3</sup> Powis,<sup>4</sup> and others have shown that the nature of the electric charge on a colloid depends on the medium.

Wilson,<sup>5</sup> Michaelis,<sup>6</sup> Oakley,<sup>7</sup> and others consider that the electrical charge on a colloid comes from the surface dissociation of the solid particle. Thus Michaelis believes that the electrical charge on a mastic micelle comes from the dissociation of this substance into a complex organic anion, which remains on the surface of the colloid, whilst the H<sup>+</sup> ions envelope the colloid particle. He believed that this process resembles the hydrogen electrode but lately he has given up this analogy because there is no experimental support.

Wilson and Oakley have tried to apply the concept of the Donnan equilibrium in explaining the origin of the charge on colloids, and Oakley has calculated the potential difference of a colloid particle such as silicic acid from this view. He has shown that silicic acid becomes unstable in presence of Ca(OH)<sub>2</sub>, because at the surface calcium silicate is formed which does not dissociate, as it is very sparingly soluble in water. With KCl, however, silicic acid ought to be remarkably stabilised in presence of an alkali. Freundlich and Cohn,<sup>8</sup> and Ghosh and Dhar in a recent communication have proved that a sol of silicic acid becomes unstable in presence of an alkali towards all electrolytes. The application of the Donnan equilibrium is not helpful in explaining the origin of the electric charge. It may be easy to conceive the dissociation at the surface of such substances as gums, silicic acid and vanadic acid which have a certain amount of solubility but it is difficult to extend this view to the cases of Fe(OH)<sub>3</sub>, Cr(OH)<sub>3</sub>, As<sub>2</sub>S<sub>3</sub>, etc., which are known to be very insoluble substances.

We are of the opinion that in all cases the electrical charge originates mostly from the preferential adsorption of ions present in the medium. Thus Fe(OH)<sub>3</sub> is positive because of the adsorption of either Fe<sup>+++</sup> or H<sup>+</sup> ion or both; mastic is negative as it adsorbs the complex anion from the organic acid obtained from the hydrolysis; silicic acid owes its electrical charge to the preferential adsorption of the silicate ion either from the sodium salt or

<sup>1</sup> J. Chim. phys., 2, 601 (1904).

<sup>2</sup> J. Physiol., 24, 288 (1899).

<sup>3</sup> J. prakt. Chem., (2) 72, 39 (1905); 73, 374 (1906).

<sup>4</sup> J. Chem. Soc., 107, 818 (1905).

<sup>5</sup> J. Am. Chem. Soc., 38, 1892 (1916).

<sup>6</sup> "Colloid Symposium Monograph," 2, (1925).

<sup>7</sup> J. Phys. Chem., 30, 902 (1926).

<sup>8</sup> Kolloid-Z., 36, 28 (1926).

from silicic acid which may be present in solution. In all cases the counterparts of the adsorbed ions form a double layer on the sides of the colloid particle whose thickness will now be considered.

Lamb<sup>1</sup> believes that the thickness of this double layer is of the order  $10^{-8}$  cm., i.e. it is only about one molecule deep. Considerable modification of the thickness of this has been made by Pellat,<sup>2</sup> McBain,<sup>3</sup> and others. In view of the fact that there exists a great adhesive force between the liquid at the

TABLE I\*  
Adsorption by Manganese Dioxide

Electrolyte	Concentration			
	M/5	M/10	M/25	M/50
KCl	—	4.20	4.00	4.11
LiCl	2.87	2.40	2.95	2.87
BaCl <sub>2</sub>	1.20	1.11	1.18	1.00
UO <sub>2</sub> (NO <sub>3</sub> ) <sub>2</sub>	1.21	1.44	1.51	1.46
SrCl <sub>2</sub>	0.76	0.80	0.80	0.81
Cs(NO <sub>3</sub> ) <sub>3</sub>	1.14	0.90	0.99	1.41
AgNO <sub>3</sub>	—	—	about 4.0	—
Th(NO <sub>3</sub> ) <sub>4</sub>	—	—	about 0.3	—
Al(NO <sub>3</sub> ) <sub>3</sub>	—	—	about 0.4	—
CuSO <sub>4</sub>	4.19	—	about 2.5	—

\* Compare J. Phys. Chem., 31, 997 (1927); under the indicated concentrations the differences in the amounts of adsorption by the precipitate and the colloid have been expressed in millimoles.

surface of contact and the colloid particles, McBain rightly concludes that the thickness of the double layer must be much greater than one molecular dimension in order that the colloid particles possess a considerable facility of slip when the particles are under an electrical strain.

Calculating the charge from the potential measurements obtained by cataphoretic experiments the electrical charge on the colloid particle comes to be  $10^{-5}$  e.s.u., when the thickness of the double layer is taken to be  $10^{-8}$  cm. We have calculated the value of this electrical charge on colloid particles from our adsorption experiments with colloids and with the freshly precipitated substances under identical conditions. In several papers from this laboratory we have emphasized that the adsorption with a colloid is due to two causes:— (1) adsorption due to the neutralisation of the electrical charge and (2) adsorption by the uncharged surface due to the residual affinity. The adsorption by the precipitated substance therefore gives the amounts adsorbed due to the second cause. Subtracting the value of adsorption by a definite weight of a precipitate from the amount of adsorption by the same amount of colloid we get the amount adsorbed in order to neutralise the electric charge.

<sup>1</sup> Phil. Mag., 25, 60 (1888).

<sup>2</sup> See Perrin: J. Chim. phys., 2, 601 (1904).

<sup>3</sup> J. Phys. Chem., 28, 706 (1924).

In Tables I-III we shall record our results with manganese dioxide, ferric hydroxide, and zirconium hydroxide sols and precipitates.

TABLE II

Electrolyte	Adsorption by Ferric Hydroxide			
	Concentration Milliequivalents	Adsorption in milliequivalents		Difference
		50 c.c.	by 1 gm. of colloid	
K <sub>2</sub> SO <sub>4</sub>	40.00	3.492	0.416	3.076
	10.00	2.548	0.352	2.196
	5.00	1.920	0.154	1.766
	2.50	1.300	0.132	1.168
K <sub>2</sub> C <sub>2</sub> O <sub>4</sub>	40.00	3.74	0.53	3.21
	10.00	2.80	0.47	2.33
	5.00	2.12	0.45	2.67
	2.50	1.44	0.34	1.10

TABLE III

Electrolyte	Adsorption by Zirconium Hydroxide			
	Concentration Milliequivalents	Adsorption in milliequivalents		Difference
		50 c.c.	by 1 gm. of colloid	
K <sub>2</sub> SO <sub>4</sub>	40.00	3.22	2.81	0.41
	10.00	2.22	1.64	0.58
	5.00	1.80	1.24	0.56
	2.50	1.40	0.84	0.56
K <sub>2</sub> C <sub>2</sub> O <sub>4</sub>	40.00	3.42	3.06	0.36
	10.00	2.28	1.80	0.46
	5.00	1.82	1.26	0.56
KCl	40.00	3.92	3.06	1.12
	30.00	3.18	2.34	1.80
	20.00	2.66	1.80	1.66
	10.00	1.80	1.26	1.20

From the above tables we find that the maximum difference between the two values hardly exceeds 4 milliequivalents per gram. of the adsorbent as observed with silver nitrate and manganese dioxide. This is the amount necessary for neutralising the electrical charge on the colloid particles. Now considering the colloidal dimension of the order  $10^{-6}$  cm. the mass of one colloid particle is  $5\rho \cdot 10^{-19}$  gm. where  $\rho$  is the density of  $MnO_2$ . The number of colloid particles per gram is  $\frac{1}{5\rho} \times 10^{19}$  and the number of  $Ag^+$  ions taken up by one colloid particle is:

$$\frac{.004 \times 6.05 \times 10^{23}}{1/5\rho \times 10^{19}} \text{ i.e. } 1.2 \times \rho \times 10^3,$$

and taking  $\rho$  as 2 we get the number of  $\text{Ag}^+$  ions adsorbed by one colloid particle for charge neutralisation is  $2.4 \times 10^8$ . Therefore the electrical charge on a colloid particle is  $2.4 \times e \times 10^8$  i.e. of the order  $10^{-8}$  e.s.u. We are therefore of opinion that this small value of the electrical charge on a colloid particle can be accounted for if we consider that the thickness of the double layer, "d" in the usual equation  $V = q \frac{d}{K\epsilon^2}$  be of the order  $10^{-7}$  cm. and not  $10^{-8}$  cm. as has been hitherto supposed.

From our experiments on manganese dioxide, zirconium hydroxide and ferric hydroxide we observe that the difference in the amounts of adsorption between the colloid and the precipitate is sometimes as low as 0.37 milliequivalent on calculation yields a still lower value of the electrical charge on the colloid particles. Moreover, it has been proved that the adsorption by a precipitate decreases with time due to ageing and agglomeration of the particles. Hence, the difference as observed is really much greater in each case than the amount which actually brings about the charge neutralisation. We therefore definitely believe that the thickness of the double layer cannot be less than  $10^{-7}$  cm.

It has often been a question difficult to answer, why a small concentration of an electrolyte is actually potent in coagulation in spite of the fact that at the precipitating concentration of the electrolyte more than 90% is left unadsorbed. In the case of bivalent and trivalent ions, however, the minimal concentrations necessary for coagulation are very small and in these cases larger proportions of the electrolytes are effective in coagulation than in the case of a monovalent ion.

These facts can be explained from the following considerations:—

When an electrolyte, say KCl, is added to a negatively charged sol then only those ions which are very near the colloid particles or those that are approached by the colloid particles because of their Brownian movement, should only be effective in coagulation. Those potassium ions which are distantly situated cannot be attracted by the particles as the colloid behaves as a neutral substance. We have already reported that a colloid consists of a micelle carrying a charge of  $10^{-8}$  e.s.u. and is surrounded by a layer of oppositely charged ions separated by at least  $10^{-7}$  cm. and the system as a whole appears to be electrically neutral. It should also be pointed out that the  $\text{K}^+$  ions will first meet the positive envelope of the colloid and unless it possess a definite minimum energy it cannot penetrate this envelope and meet the central core and bring about charge neutralisation. It is therefore obvious that in order to bring the density of charge below a certain value only few  $\text{K}^+$  ions will be effective because it is only a few  $\text{K}^+$  ions which possess the required minimum energy  $P$  necessary for penetration. In the case of the bivalent and trivalent ions the value of this minimum energy is necessarily smaller than that of a monovalent ion because in addition to this energy the ions reaching the envelope of the double layer have greater electrical attraction for the central core of the micelle. We shall now deduce a relation be-

tween the coagulating powers of ions of different valencies from the above considerations.

Let us imagine that colloid particle moves through a distance within a small time  $dt$  so as to sweep out a volume  $dv$  of the medium. The number of ions,  $n$ , embraced by the colloid particle in this movement, which possess an energy equal or greater than  $P$  is given by

$$n = NkTe^{-P/RT} dv. \quad (1)$$

where  $N$  denotes the concentration of the added ion.

Let us suppose that on the average each particle of the colloid has a charge  $q$  so that the potential energy of an ion of valency,  $x$ , due to the charge at a distance  $r$  is  $\frac{qxe}{Dr}$  where  $D$  is the dielectric constant of the medium. If  $P_x$  is the energy due to electro-ionic attraction of an ion with a valency  $x$  then the total energy of the ion at a distance,  $r$ , from the colloid particle is  $\rho_x + \frac{qxe}{Dr}$  and this is equal to  $P$ , the minimum energy which the ions must possess in order that they may effect coagulation.

Therefore

$$P_x = \rho - \frac{qxe}{Dr} \quad (2)$$

Then from equation (1) the number of ions,  $n_x$ , having an energy  $\rho_x$  is given by

$$n_x = NkTe^{P - \frac{qxe}{Dr}} dv \quad (3)$$

It is clear that in order to bring the density of charge on the colloid particle to a minimum value necessary for coagulation the number of an ion of valency  $x$  will be  $1/x$  times the number of monovalent ions.

$$\text{i.e. } n_1 = 2 n_2 = 3 n_3 = \dots = x n_x = \quad (4)$$

Now if  $N_1, N_2, N_3, \dots, N_x$  be the precipitating concentrations of uni, bi, tri, ...  $x$ -valent ions, then

$$n_1 = N_1 k T e^{-\frac{P - qe/Dr}{kT}} dv.$$

$$n_2 = N_2 k T e^{-\frac{P - 2qe/Dr}{kT}} dv.$$

$$n_3 = N_3 k T e^{-\frac{P - 3qe/Dr}{kT}} dv.$$

.....

$$n_x = N_x k T e^{-\frac{P - xqe/Dr}{kT}} dv.$$

Then from (4) we have:

$$\begin{aligned} N_1 k T e^{-\frac{P - qe/Dr}{kT}} dv &= 2 N_2 k T e^{-\frac{P - 2qe/Dr}{kT}} dv = 3 N_3 k T e^{-\frac{P - 3qe/Dr}{kT}} dv \\ &\dots = X N_x k T e^{-\frac{P - xqe/Dr}{kT}} dv = \dots \end{aligned}$$

$$\text{or } N_1 = 2N_2 e^{\frac{q_2/D_2}{kT}} = 3N_3 e^{\frac{2q_3/D_3}{kT}} = \dots = xN_x e^{\frac{(x-1)q_x/D_x}{kT}} = \dots$$

$$\therefore N_1 : N_2 : N_3 : \dots : N_x$$

$$= 1 : \frac{1}{2}\alpha : \frac{1}{3}\alpha^2 : \dots : \frac{1}{x}\alpha^{x-1}$$

where  $\alpha = e^{-\frac{q_1/D_1}{kT}}$ , i.e.,  $\alpha$  is a proper fraction.

Hence, the coagulating powers of mono-, bi-, and trivalent ions are in the ratio of  $1:0:\frac{1}{2}\alpha^2$ .

In the following calculations we have not considered the difference in ionic mobilities and the different amounts of adsorption of coagulating ions originating from residual chemical affinity of the colloid. It is apparent that an ion which has a greater velocity will require lesser amount of energy "P" to penetrate the double layer and cause charge neutralisation. Thus comparing the coagulating influence of monovalent ions like H', Cs', Rb', K', Li, etc. it will be found to be more prominent with a fast moving ion than a slow moving one, and hence the coagulating powers will arrange as H' > Cs' > Rb' > K' > Na' > Li' etc. and this has been experimentally observed with several negatively charged sols.

Now let us consider two ions of same valency and of similar ionic mobility but adsorbed to different degrees by the colloid particles due to their difference in the attraction originating from the residual affinity of the colloid. In such a case the equation 2 has to be written as

$$P_x = P - \frac{q_x e}{D_r} - f(A)$$

where  $f(A)$  is the maximum adsorption<sup>1</sup> per gram of the substances. Hence, if the ion is highly adsorbed, the value of P is small and consequently the number of ions effective as coagulant is large. In other words, if an ion be highly adsorbed it will possess a greater coagulating power than an ion which is adsorbed in smaller quantities, if they be of the same valency. Freundlich<sup>2</sup> has observed that the alkaloids and dye stuffs are highly adsorbed by arsenious sulphide and this adsorption is practically complete in some cases. The order of coagulating powers is Ce > Al > Neufuchsin > crystal violet > morphine chloride > Ba > anilin chloride, strychnine nitrate > K > Na > Li, the alkaloids and the dye stuffs generally possessing much higher coagulating power than many bivalent and univalent ions. This is due to the fact that in these cases  $f(A)$  has a high value. We should, however, incidentally point out here that though Ce, and Al, ions are far less adsorbed than any of the organic cations, the coagulating powers of trivalent ions are greater than those of the highly adsorbed organic cations. This proves that the electrical attraction<sup>1</sup> plays a more important part in the phenomenon of coagulation than the attraction originating from the chemical affinity.

<sup>1</sup> Compare Chakrovarti and Dhar: Kolloid-Z., 43, 377 (1927).

<sup>2</sup> Z. physik. Chem., 73, 408 (1910).

It is evident that if there is no other complication viz. adsorption of similarly charged ion or the marked adsorbability of the precipitating ion or a great difference in the ionic velocity of the coagulating ion, the coagulation being guided simply by the electric attraction, the modified form of Whetham's rule as deduced by us will hold viz.

$$N_1 : N_2 : N_3 : \dots : N_x : \dots = 1 : \frac{1}{2}\alpha : \frac{1}{3}\alpha^2 : \dots : \frac{1}{x}\alpha^{x-1} : \dots$$

where  $\alpha = e^{-\frac{qe/Dr}{kT}}$  and is a proper fraction.

It follows, therefore, that as  $T$  or  $D$  increases or  $q$  decreases, the value of  $\alpha$  tends to unity and in the limit the precipitating concentrations of mono-, bi-, and trivalent ions are in the ratio of  $1 : \frac{1}{2} : \frac{1}{3}$ , i.e. in equivalent amounts. In all other cases the difference in their coagulating powers will be more pronounced.

It should be pointed out here that the relation of the coagulating powers of the ions of different valencies obtained by us agree better with the experimental results than Whetham's rule<sup>1</sup> based upon the probability of collisions and the assumption that each of the collisions is effective in coagulation. If Whetham's assumptions were correct, then a sufficient length of time would cause coagulation of a sol with a very small amount of an electrolyte, as at the coagulation concentration only a few percent of the added electrolyte is effective in precipitation. Powis<sup>2</sup> observed with arsenious sulphide sol that 0.3 millimol of barium chloride could not coagulate it even when left for several months, while with 0.4 millimol of barium chloride a precipitate appeared in a day or two. We have also repeatedly observed that in all cases of coagulation the concentration of the precipitating electrolyte must reach a minimum amount ("threshold value") in order to cause coagulation, in spite of the fact that only a few percent have effected the precipitation. In our calculations we have shown that all the ions added are not effective as they do not possess the energy greater than the critical value  $P$ , which an ion must have in order that it may penetrate the double layer and reach the colloid particle for charge neutralisation.

When an electrolyte is added to a colloid the first effect is charge neutralisation and then agglomeration occurs because of adherence of two or more colloid particles due to their surface energy. In a recent paper O. K. Rice<sup>3</sup> has arrived at the conclusion that colloid particles do not aggregate if  $\frac{4\pi\sigma^2r}{D}$

$> \gamma_0^\infty$  where  $\sigma$  is the surface density of electric charge,  $r$  the thickness of the double layer,  $D$  the dielectric constant of the medium and  $\gamma_0^\infty$  is the non-electrical surface tension of the colloid particle. In another relation O. K.

Rice has shown that  $\frac{4\pi\sigma^2r}{D} = \gamma_0^\infty \left(1 + \frac{c}{a^2}\right)$  where  $c$  is an integration constant

and  $a$  is the size of the colloid, which proves that the aggregation will become

<sup>1</sup> Phil. Mag., 48, 474 (1889).

<sup>2</sup> J. Chem. Soc., 109II, 734 (1916).

<sup>3</sup> J. Phys. Chem., 30, 189, 1660 (1926).



very rapid when a definite  $\sigma$  is reached. The decrease of the electrical charge on the colloid particle to a limiting value causing coagulation has been considered in this paper.

From both the equations derived by Rice we find that the surface tension of the colloid particle plays an important rôle in the phenomenon of coagulation. Similarly, Donnan<sup>1</sup> has tried to explain the stability of colloidal solutions from their capillarity. If the surface energy  $\gamma_0^\infty$  be very small, the colloid particle is stable even for a small electrical density. If, however, the value of interfacial tension between the colloid and the dispersing medium be negative, the colloid will be stable, whatever be the value of  $\sigma$ .

It has been generally believed that the colloids which are highly solvated (lyophile) possess marked viscosity, stability and lower surface tension, and are different from the other class (lyophobe) of sols. Colloidal solutions of gelatin, albumin, gum arabic, soap, etc. are definitely of the lyophilic nature but sols of vanadium pentoxide, cerium hydroxide etc. though possess high viscosity and form jellies like other hydrated colloids are neither stable towards electrolytes nor possess a markedly lower surface tension than the medium. This view that solvation and stability go hand in hand seems incorrect.<sup>2</sup>

We believe that in all cases of stability of a colloid the interfacial tension, between the surface of the colloid and the solvent should have a small value. In cases, where  $\gamma_0^\infty$  is negative it is possible that in spite of the attraction of the solid particles to form a coherent mass the total surface force may not allow the aggregation to take place even if the electrical charge on the colloid particles is completely neutralised. We are of opinion that the stability of colloid depends on the appreciable decrease in the interfacial tension on the surface due to the presence of a concentrated solution enveloping the surface of the colloid. In general it is very difficult to estimate this interfacial tension. In those cases where the substance is appreciably soluble in water, a measurement of the surface tension of the colloid can give us an idea whether the interfacial tension of the concentrated solution enveloping the colloid is lower than that of water. This is because colloidal solution is a biphasic system and so it is apparent that a few discrete particles should not affect the surface tension of the dispersing medium. The drop in surface tension observed in some cases of colloidal solutions is due to the lowering of the surface tension by the dissolved molecules of the dispersed phase.

It is well known that soap solutions are in the molecular state in appreciable amounts and they show a greater depression in the surface tension of water than many other sols and this fact can account for the stability of such solutions. Starch sols are supposed not to change the surface tension of water and it is probable that the interfacial tension between the starch particles and water is negative, but a drop in surface tension of the sol is not observed because it is not present in the medium in the molecular condition.

<sup>1</sup> Phil. Mag., 16, 47 (1901).

<sup>2</sup> Also compare, Ghosh and Dhar: Kolloid-Z., 1928.

### Summary and Conclusion

(1) The origin of electric charge on colloid particles is due to the preferential adsorption of ions from an electrolyte present in the medium. The counterparts of the adsorbed ions form a double layer and surround the colloid particles.

2. The thickness of the double layer is not of the order  $10^{-9}$  cm. as is supposed by Lamb. It is at least of the order  $10^{-7}$  cm, and the amount of electric charge on a colloid particle cannot be more than  $10^{-6}$  e.s.u. This value of the electric charge has been obtained by subtracting the adsorption value of an ion by a freshly prepared precipitate from that of the colloid.

3. It has been shown that all the ions from a coagulating electrolyte are not effective in coagulation. Only those ions which are very near the colloid particles and possess an energy greater than a definite value can neutralise the charge on the colloid particles. This view, therefore, explains the necessity of a particular concentration viz. the threshold value which an electrolyte must reach in order to effect coagulation.

4. A relation of the precipitation values of ions of different valencies for a colloid has been obtained. This is given by  $N_1:N_2:N_3 \dots = 1:\frac{1}{2}\alpha:\frac{1}{3}\alpha^2 \dots$

where  $\alpha = e \frac{-q_0/Dr}{kT}$ . This relation will hold if: (a) coagulating ions are not adsorbed by the colloid due to residual affinity; (b) they do not adsorb similarly charged ions; and (c) are not very different in their ionic mobilities.

5. If coagulation is effected by electrolytes at a very high temperature, the precipitation values tend to be equal if expressed in equivalents.

6. An ion possessing greater ionic velocity or is more adsorbable by a colloid should possess a greater coagulating power than an ion which moves slowly and is less adsorbed by the colloid. Valency, however, is the main factor in determining the coagulating power of an ion.

7. Coagulation occurs when the electrical density reaches a certain minimum value, beyond which agglomeration is very rapid. The value of this minimum electrical density depends upon the interfacial tension of the colloid particles.

8. The belief that hydrophile colloids are very stable towards electrolytes because of their high solvation is not true. The stability of some hydrophile sols depends upon their lower interfacial tension.

*Chemical Laboratory,  
Allahabad University,  
Allahabad,  
India.  
March 31, 1929.*

ADSORPTION AND THE PERMEABILITY OF MEMBRANES. I  
COPPER FERROCYANIDE AS A SEMIPERMEABLE  
MEMBRANE

BY HARRY B. WEISER

A membrane is said to be semipermeable when it permits one constituent of a solution to pass through—usually water—and does not allow diffusion of the other constituents or one or more of the other constituents. The plasma membranes of cells are natural membranes of this kind. Traube<sup>1</sup> was the first to recognize a similar semipermeability in certain gelatinous precipitates, the so-called precipitation membranes of which copper ferrocyanide is a familiar example.

To account for the action of semipermeable membranes, Traube conceived of them as atomic or molecular sieves through which progressively larger molecules diffused with increasing difficulty. Thus a copper ferrocyanide membrane was believed to contain pores large enough for the small molecules of water to get through but too small to allow the larger molecules of sugar to pass. This view was shown to be inadequate by the observations of Tammann,<sup>2</sup> Walden,<sup>3</sup> I. Traube,<sup>4</sup> Barlow,<sup>5</sup> and others<sup>6</sup> who made comparative tests on a number of semipermeable membranes with a number of diffusing substances. If the action is that of a sieve, it should be possible to arrange the membranes in a series in the order of their permeability. On the contrary, it was found that a membrane quite impermeable to most substances may be more permeable to some than is a membrane which, in general, possesses high permeability. Moreover, the impermeability of a membrane such as rubber to water and its permeability to the much larger molecules of benzene and pyridine cannot be accounted for on the sieve theory.

The solution theory of the action of the semipermeable membrane postulates that a membrane is permeable to such substances as dissolve in it and impermeable to those that do not. This view was anticipated by Liebig<sup>7</sup> as early as 1848 when he said: "The volume changes of two miscible liquids which are separated from each other by a membrane depends upon the unequal wetting or attraction which the membrane exerts on the two liquids." The first experimental work with the object in view of testing this theory was carried out by L'hermite<sup>8</sup> in 1855. In a test tube he placed some water, above

<sup>1</sup> *Archiv. Anat. Physiol.*, 86 (1867).

<sup>2</sup> *Z. physik. Chem.*, 10, 255 (1892).

<sup>3</sup> *Z. physik. Chem.*, 10, 699 (1892).

<sup>4</sup> *Phil. Mag.*, (6) 8, 704 (1904).

<sup>5</sup> *Phil. Mag.*, (6) 10, 1 (1915); Findlay and Short; *J. Chem. Soc.*, 87, 819 (1905).

<sup>6</sup> Kahlenberg; *J. Phys. Chem.*, 10, 169 (1906).

<sup>7</sup> "Ursachen der Säftebewegung" (1848); *Liebig's Ann.*, 121, 78 (1862).

<sup>8</sup> *Ann. Chim. Phys.*, (3) 43, 420 (1855).

this a thin layer of castor oil, and above this a layer of alcohol. In the course of a few days the alcohol had passed through the castor oil to the water, leaving but two layers in the tube. Turpentine was substituted for the oil with the same results. Again, when a layer of chloroform was separated from a layer of ether by a layer of water, the ether passed through the water to the chloroform. As a result of similar observations on eight different combinations of this kind, L'hermite reached the conclusion that substances which pass through membranes first dissolve in them. This mechanism has been supported by the work of numerous investigators.<sup>1</sup> Thus Kahlenberg found that benzene, toluene, and pyridine, which are soluble in rubber diffuse through rubber, whereas water which is insoluble in rubber does not pass through.<sup>2</sup> Moreover, trichloroacetic acid passes through a rubber membrane when dissolved in benzene but only very slowly when dissolved in water.

While solution in the membrane may be a necessary and sufficient criterion for semipermeability in certain cases, Bigelow<sup>3</sup> and Bartell<sup>4</sup> demonstrated conclusively that osmotic effects can be obtained with inert material where neither solution nor chemical reactions can take place. Thus porous cups served as semipermeable membranes when the pores were sufficiently fine or when they were clogged to a certain extent with such substances as barium sulfate, lead chromate, lead sulfate, etc. Moreover, finely divided material such as silica, carbon, metallic copper, silver, and gold acted as semipermeable membranes when compressed into discs containing very fine pores. The limits of the pore diameters between which osmosis can take place are not definitely known but they undoubtedly vary from substance to substance. Bartell found the upper limit to be around 0.9 micron with unglazed porcelain clogged with various materials. This is, of course, much too large to represent the dimensions of molecular interstices which Traube believed to be essential for semipermeability in membranes.

The osmotic phenomena observed with a distinctly porous non-soluble membrane such as a clogged porous plate, is doubtless the result of what is termed negative adsorption. If a solid adsorbent takes up relatively more of a solvent than of the dissolved substance, the phenomenon is known as negative adsorption and the solution becomes more concentrated. Mathieu<sup>5</sup> observed this phenomenon with a number of solutions using porous plates, parchment and animal membranes, and capillaries. With normal solutions, the concentration in certain capillary spaces was found to be as low

<sup>1</sup> Graham: *Phil. Trans.*, 144, 177 (1854); 151, 183 (1861); Nernst: *Z. physik. Chem.*, 6, 37 (1897); Tammann: 10, 255 (1892); Overton: 22, 189 (1897); Barlow: *Phil. Mag.*, (6) 10, 1 (1905); Kahlenberg: *J. Phys. Chem.*, 10, 169 (1906).

<sup>2</sup> Actually rubber dissolves or adsorbs water slightly and a rubber membrane is slightly permeable to water. Andrews and Johnston: *J. Am. Chem. Soc.*, 46, 640 (1924); Lowry and Kohman: *J. Phys. Chem.*, 31, 23 (1927); Schumacher and Ferguson: *Ind. Eng. Chem.*, 21, 158 (1929).

<sup>3</sup> *J. Am. Chem. Soc.*, 29, 1576, 1675 (1907); 31, 1194 (1909); Bigelow and Robinson: *J. Phys. Chem.*, 22, 99, 153 (1918).

<sup>4</sup> *J. Phys. Chem.*, 15, 659 (1911); 16, 318 (1912); *J. Am. Chem. Soc.*, 36, 646 (1914); 38, 1029, 1036 (1916).

<sup>5</sup> *Ann. Physik*, (4) 9, 340 (1902).

as 0.1 normal. The difference in concentration increases with decreasing radius of the capillaries and Mathieu concludes that with sufficiently fine capillaries water alone would be taken up: "The result of the investigation, that diluted aqueous solutions are formed not only in membranes but in general in capillary spaces if they are immersed in salt solutions, leads to a consideration of the properties of semipermeable membranes. If the capillaries in a semipermeable wall are considered to be so fine that only weak solutions can exist in them, one has an explanation of the fact that these walls in extreme cases are permeable for the pure solvent only."

The importance of negative adsorption for the theory of semipermeable membranes was recognized also by Nathansohn,<sup>1</sup> Bancroft,<sup>2</sup> and Tinker.<sup>3</sup> Thus Bancroft says: "If this conclusion is true and general, it accounts for the results of Bigelow and of Bartell, who found that osmotic phenomena appeared in porous cups when the pores were sufficiently fine or were clogged sufficiently. It is clear that we can get osmotic phenomena in two distinct ways, depending on whether we have a continuous film or a porous one. In the case of a continuous film, it is essential that the solvent shall dissolve in the membrane and that the solute shall not. Since the permeability is not dependent on adsorption, there is no reason why there should be any fundamental differences between the adsorption of a solution which does pass through the membrane and of one which does not pass through.

"With a porous film we shall get osmotic phenomena only when the negative adsorption is so marked that the pore walls adsorb practically pure solvent and when the diameters of the pores are so small that the adsorbed film of pure solvent fills the pores full. There is, therefore, an important difference between a solute which does pass through a membrane having very fine pores and one which does not pass through, in that the first is adsorbed by the membrane and the second is not."

Since a gelatinous precipitate consists of myriads of particles enmeshed into a network which entrains liquid,<sup>4</sup> it is probable that copper ferrocyanide membranes are porous in the sense that a fine porous plate is porous and are semipermeable toward sugar solutions, therefore, because of strong negative adsorption. Tinker examined these artificial membranes microscopically and arrived at the conclusion that they are granular in character<sup>5</sup> with particles having diameters between 100 and 1000 $\mu$ . It is probable that the primary particles are much smaller than this and that what he was measuring was the diameter of secondary particles from partial agglomeration. In any event, it is difficult to see how even an approximate estimate of particle size could be arrived at from his published photographs. The important thing is that apparently independent of Mathieu, Nathansohn, or Bancroft, he concluded that negative adsorption in such a porous system is the primary

<sup>1</sup> Jahrb. wiss. Botan., 40, 431 (1904).

<sup>2</sup> J. Phys. Chem., 21, 441 (1917).

<sup>3</sup> Proc. Roy. Soc., 92A, 357 (1916); 93A, 266 (1917).

<sup>4</sup> Cf. Weiser: "The Hydrous Oxides," 12 (1926).

<sup>5</sup> Cf. also, Gurchot: J. Phys. Chem., 30, 99 (1926).

cause of semipermeability. In support of this view, he demonstrated that cane sugar which ordinarily does not diffuse through a copper ferrocyanide membrane is adsorbed negatively by the salt. Ten-gram samples of finely divided copper ferrocyanide were shaken with sugar solutions of various strengths and the change in concentration determined polarimetrically. From this, the amount of water adsorbed was calculated. The results with four samples dried in different ways and to different degrees are given in Table I. Correction was made for any water present in the adsorbent before immersing in the solution. It will be seen that sample 3, which has been dried in air, adsorbs the most water and sample 1, which was completely dehydrated in a hot oven adsorbs the least water. Complete dehydration is evidently accompanied by partial coalescence with consequent decrease in specific surface.

TABLE I  
Adsorption of Water from Sugar Solutions by  $\text{Cu}_2\text{Fe}(\text{CN})_6$

Approximate strength of cane sugar solutions percent	Water adsorbed by 100 grams of dry $\text{Cu}_2\text{Fe}(\text{CN})_6$			
	Dried completely in steam oven	Dried over $\text{H}_2\text{SO}_4$ , 10 grams contain 0.689 gram $\text{H}_2\text{O}$	Dried in air at $80^\circ$ for 3 hours, 10 grams contain 1.38 grams $\text{H}_2\text{O}$	Not dried, 10 grams contain 3.14 grams $\text{H}_2\text{O}$
5	—	—	27.0	—
10	18.2	23.9	22.7	24.5
20	15.0	—	22.5	20.1
40	13.4	18.0	22.2	20.0
60	13.2	14.7	20.8	14.0

While the impermeability of a copper ferrocyanide membrane to sugar is doubtless due to the observed negative adsorption, the cause of the impermeability of a copper ferrocyanide membrane to ferrocyanide ion is not obvious. That ferrocyanide ion does not pass the membrane was pointed out by Tammann<sup>1</sup> and Walden<sup>2</sup> and confirmed by Donnan<sup>3</sup> who tested his theory of membrane equilibria by placing potassium or sodium chloride on one side of a copper ferrocyanide membrane and potassium or sodium ferrocyanide on the opposite side. A Donnan equilibrium was set up as a result of the failure of the ferrocyanide ion to diffuse through. If Bancroft<sup>4</sup> is right in his contention that there is no such thing as a molecular sieve for substances in true solution, then the membrane cannot be functioning as a sieve which screens out the relatively large ferrocyanide ion. As we shall see, the membrane is permeable to much larger molecules than ferrocyanide so that the action is not that of a sieve. Since the membrane is impermeable

<sup>1</sup> Z. physik. Chem., 10, 255 (1892).

<sup>2</sup> Z. physik. Chem., 10, 699 (1892).

<sup>3</sup> Donnan and Allmand: J. Chem. Soc., 105, 1941 (1914); Donnan and Garner: 115, 1313 (1919).

<sup>4</sup> J. Phys. Chem., 29, 966 (1925).

to sugar because of strong negative adsorption one might attribute the impermeability of ferrocyanide to a similar cause. This is unsatisfactory, however, since it is known that ferrocyanide ion is adsorbed sufficiently strongly by copper ferrocyanide to peptize the gel as a stable negative sol. Indeed copper ferrocyanide gel always contains alkali ferrocyanide which is retained so tenaciously that the adsorption from moderately concentrated solutions may be regarded as almost irreversible. It was suggested recently<sup>1</sup> that strong negative adsorption by the adsorption complex prevents the passage of both sugar and ferrocyanide through the membrane. This problem is dealt with in the following experiments.

#### Diffusion Experiments

To check up the question of the alleged impermeability of copper ferrocyanide membrane to ferrocyanide ion the following experiments were carried out: Parchment thimbles 1.5 cm in diameter and 10 cm in length were impregnated with a copper ferrocyanide membrane by placing an M/5  $K_4Fe(CN)_6$  solution on the inside of the thimble, and M/5  $CuSO_4$  on the outside. After standing for three or four days, the operation was repeated with the copper salt on the inside. The thimbles were then placed in dilute copper sulfate for a day to ensure the removal of all potassium ferrocyanide, after which they were kept in contact with distilled water changed repeatedly for one week, before using. Ten-cubic-centimeter portions of solutions of potassium ferrocyanide of varying strength were placed on the inside of the membranes which were suspended in large test tubes and surrounded by sugar solutions found by trial to be isotonic with the salt solutions. Tests for ferrocyanide in the sugar solutions were made at intervals by the Prussian blue test. If the membrane was perfect at the start, it was found to be impermeable indefinitely to N/5, N/3, and N/2.5 solutions of  $K_4Fe(CN)_6$ . Most membranes failed within a few days with solutions as strong as N and 2 N; but one membrane retained an N solution 18 days and was still good when the experiment was stopped. The greater tendency for the membrane to allow relatively high concentrations of ferrocyanide to pass is probably due to partial coagulation of the colloidal film by the salt thereby opening up cracks at weak points in an imperfectly formed membrane.

The impermeability of the membrane to ferrocyanide is further shown by the following ultrafiltration experiment: A good grade of parchment paper was stretched tightly over a bell-jar and impregnated with copper ferrocyanide by a suitable modification of the procedure employed for impregnating the thimbles. A 7 mm disk of the membrane was placed in an ultrafilter, into which was poured 100 cc of N/10  $K_4Fe(CN)_6$  solution and a pressure of 150 pounds per square inch was applied. Filtration was very slow but 30 cc of ferrocyanide-free filtrate was obtained before a leak developed in the filter.

<sup>1</sup> Weiser: "The Colloidal Salts," 283 (1928).

### Adsorption Experiments

*Adsorption of  $K_4Fe(CN)_6$  by dried  $Cu_2Fe(CN)_6$ .* To determine whether dried copper ferrocyanide formed in the presence of excess  $K_4Fe(CN)_6$  adsorbs ferrocyanide positively or negatively the following experiment was carried out: A copper ferrocyanide gel was precipitated by adding a slight excess of  $K_4Fe(CN)_6$  solution to copper chloride solution and the gel washed by decantation by the aid of the centrifuge. Unfortunately, it was impossible to remove all the ferrocyanide from the supernatant solution by washing with pure water since the gel is readily peptized as a negative sol. Accordingly, the washing was carried out with a 0.05 N KCl solution. The washed gel was dried on the steam bath, ground to a fine powder and a 2.5 gram sample thoroughly mixed with 25 cc of N/50  $K_4Fe(CN)_6$  solution. After standing several hours, a 10 cc sample of the clear supernatant solution was titrated with potassium permanganate: 2.6 cc of solution were required as compared with 6.75 cc for 10 cc of the original solution. This definite evidence of positive adsorption of ferrocyanide ion by the dry copper ferrocyanide indicates that the adsorption of ferrocyanide ion is reversible. Washing the gel formed in the presence of excess ferrocyanide removed a part of the adsorbed ion which was taken up again when the dry salt was placed in the  $K_4Fe(CN)_6$  solution. It might be argued that chloride in the wash water displaced the adsorbed ferrocyanide and that there would be no reversal of adsorption by washing with pure water. This seems altogether unlikely, however, since the adsorption of chloride is usually very much less than that of tetravalent ferrocyanide. Moreover, reversal of adsorption is strongly indicated by the peptization which follows washing of the gel with pure water. Further light is thrown on the situation by the adsorption isotherms of a number of salts with copper ferrocyanide gel as adsorbent.

*Adsorption of  $K_4Fe(CN)_6$  by  $Cu_2Fe(CN)_6$  gel.* Solutions of  $K_4Fe(CN)_6$  and of  $CuCl_2$  were prepared such that 50 cc of the former was exactly equivalent to 100 cc of the latter and on mixing the respective amounts, theoretically 0.5 gram  $Cu_2Fe(CN)_6$  was formed. The adsorption isotherm was obtained by taking 100 cc portions of  $CuCl_2$  solution, adding increasing amounts of  $K_4Fe(CN)_6$  solution above 50 cc, and determining the equilibrium concentration of ferrocyanide. A difficulty with the procedure is that the copper ferrocyanide gel is not precipitated in the presence of a small excess of  $K_4Fe(CN)_6$  but remains suspended as a negative sol. At the outset the concentration of the intermicellar liquid was determined by ultrafiltration of the sol through a cellophane membrane and analysis of the ultrafiltrate. It was later found that almost identical results were obtained by increasing slightly the potassium chloride concentration of the solution thereby preventing the peptization of the gel so that the supernatant solution would be analyzed directly for ferrocyanide. Since this procedure required much less time than that involving ultrafiltration, it was the one adopted.

The mixing of the solutions was done in a 250 cc wide-mouth bottle. In the bottle were placed the ferrocyanide solution, 10 cc of 2.5 N KCl, and



enough water to make exactly 150 cc. One hundred cubic centimeters of the  $\text{CuCl}_2$  solution were transferred to a 200 cc flask with a short neck 3 cm in diameter inserted through a rubber stopper which fitted the bottle. In order to retain the solution when the flask was inverted, the neck of the latter was fitted with a thin slice of rubber cut from a stopper. To mix the solutions the neck of the flask was inserted firmly in the bottle which was given a jar thereby dislodging the thin stopper from the neck of the flask and allowing very rapid and thorough mixing of the solutions. After standing for 24 hours and centrifuging, samples of the supernatant solutions were withdrawn and analyzed for ferrocyanide by titration with standard potassium permanganate according to the method of Müller and Diefenthaler.<sup>1</sup> Since quite dilute solutions were used in some cases, special precautions were taken to get a definite endpoint.<sup>2</sup>

The results of the observations are given in Table II and shown graphically in Fig. 1. The adsorption, in mols  $\text{K}_4\text{Fe}(\text{CN})_6$  per mol  $\text{Cu}_2\text{Fe}(\text{CN})_6$ , plotted against the equilibrium concentration of  $\text{K}_4\text{Fe}(\text{CN})_6$ , in millimols per liter, is shown in the upper curve while the logarithm of the adsorption against the logarithm of the equilibrium concentration is shown in the lower curve.

TABLE II  
Adsorption of  $\text{K}_4\text{Fe}(\text{CN})_6$  by  $\text{Cu}_2\text{Fe}(\text{CN})_6$

Solutions mixed (Total volume 250 cc)		Equilibrium concentration of $\text{K}_4\text{Fe}(\text{CN})_6$ Millimols per liter	$\text{K}_4\text{Fe}(\text{CN})_6$ adsorbed	
$\text{CuCl}_2$	$\text{K}_4\text{Fe}(\text{CN})_6$		gram per gram	mol per mol
100	50	0.0	0.0000	0.0000
100	60	0.0	0.2172	0.2000
100	70	0.0	0.4344	0.4000
100	75	0.0692	0.5292	0.4782
100	80	0.2308	0.6080	0.5598
100	90	0.9486	0.6932	0.6382
100	100	1.9237	0.7308	0.6728
100	140	6.2705	0.7994	0.7360
100	140	22.0763	0.9286	0.8550

These observations show the marked adsorption of freshly formed copper ferrocyanide gel for potassium ferrocyanide. Thus it will be seen that approximately 0.45 mol  $\text{K}_4\text{Fe}(\text{CN})_6$  per mol of  $\text{Cu}_2\text{Fe}(\text{CN})_6$  is taken up before the equilibrium concentration of  $\text{K}_4\text{Fe}(\text{CN})_6$  in contact with the gel is appreciable. It has been well known for a long time that  $\text{Cu}_2\text{Fe}(\text{CN})_6$  cannot be prepared pure by the interaction of  $\text{CuCl}_2$  and  $\text{K}_4\text{Fe}(\text{CN})_6$ . Thus Duclaux<sup>3</sup> claims that the formula for the precipitate must be represented by the general formula  $\text{Cu}_m\text{K}_n\text{Fe}(\text{CN})_6$  when  $m + n/2 = 2$ . Duclaux believes the potassium

<sup>1</sup> Z. anorg. Chem., 67, 418 (1910).

<sup>2</sup> Weiser and Sherrick: J. Phys. Chem., 23, 205 (1919).

<sup>3</sup> J. Chim. phys., 5, 29 (1907).

ferrocyanide to be combined with the copper salt forming a series of definite double salts. It seems more likely, however, that the gel is copper ferrocyanide with potassium ferrocyanide adsorbed in varying amounts depending on the relative concentrations of the salts and the conditions of precipitation. This does not preclude the formation of definite double salts under certain conditions; but the composition of the precipitated gel can be varied continuously over such a wide range that one is not justified in concluding that a double salt is formed simply from the analysis of an amorphous mass.

From the form of the adsorption isotherm shown in Fig. 1, it might be argued that a definite double salt was formed of the composition  $5\text{Cu}_2\text{Fe}$

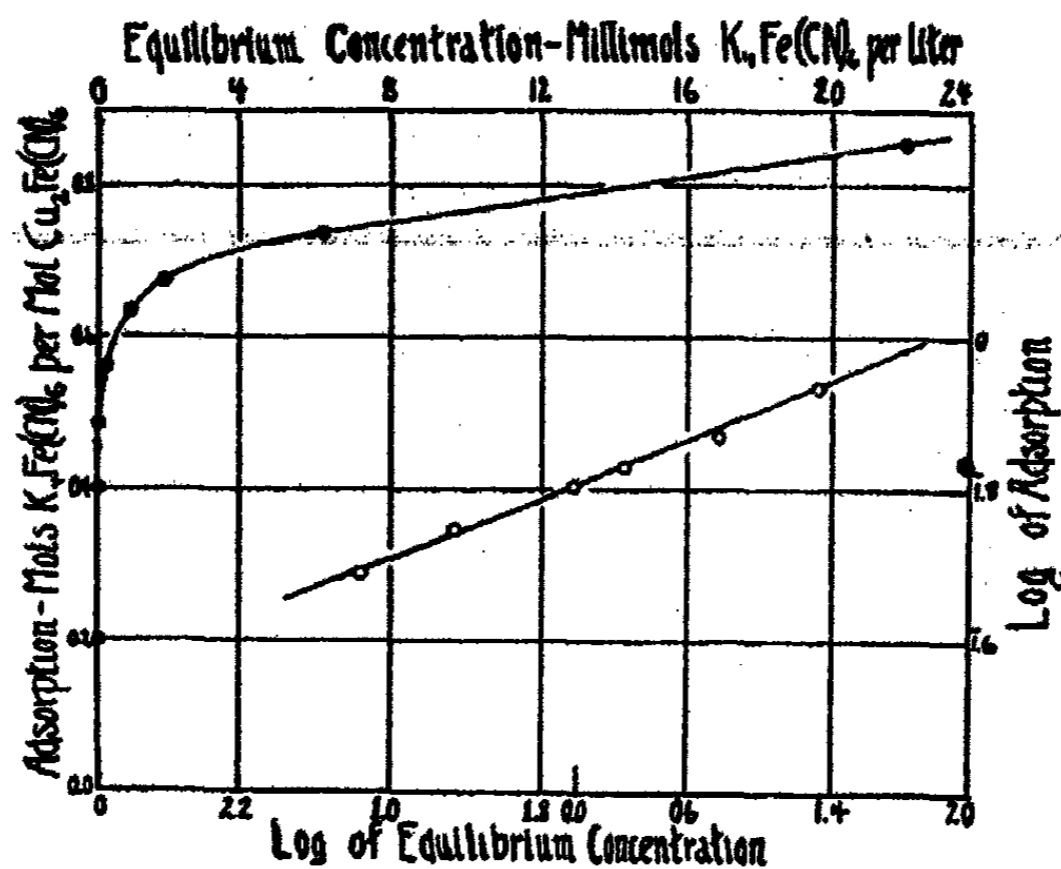

FIG. 1  
Adsorption of  $\text{K}_4\text{Fe}(\text{CN})_6$  by  $\text{Cu}_2\text{Fe}(\text{CN})_6$  Gel.

$(\text{CN})_6 \cdot 2\text{K}_4\text{Fe}(\text{CN})_6$  or  $\text{Cu}_{10}\text{K}_8[\text{Fe}(\text{CN})_6]_7$ , and that the upper portion of the curve represents the adsorption of  $\text{K}_4\text{Fe}(\text{CN})_6$  by this double salt. While this might be true, there is no evidence to date to support it. Numerous crystalline alkali- and alkaline earth-cupric ferrocyanides have been described by Bolley,<sup>1</sup> Wonfor,<sup>2</sup> and Wyruboff<sup>3</sup> but Messner<sup>4</sup> showed that the only ones that exist have the simple formula  $\text{X}'_2\text{CuFe}(\text{CN})_6$  where  $\text{X}' = \text{K}, \text{Na}$  and  $\text{NH}_4$ , or  $\text{X}''\text{CuFe}(\text{CN})_6$  where  $\text{X}'' = \text{Mg}, \text{Ca}, \text{Sr},$  and  $\text{Ba}$ . A further indication that the gel obtained as described above does not contain a double salt is furnished by the curve Fig. 1, using logarithmic coordinates. The points are found to lie more nearly on a straight line if the adsorption values are taken as given instead of subtracting from each a constant value, say, 0.4. This indicates that the adsorption curve actually passes through the origin

<sup>1</sup> Liebig's Ann., 106, 228 (1858).

<sup>2</sup> Jahresber., 1862, 233.

<sup>3</sup> Ann. Chim. Phys., (5) 8, 444 (1876).

<sup>4</sup> Z. anorg. Chem., 8, 368 (1895).

and that the equilibrium concentration approaches but does not reach zero when the adsorption is between 0.0 and 0.45 mol  $K_4Fe(CN)_6$  per mol of copper salt. In this region a more delicate analytical method would be required to show the variation from zero concentration of  $K_4Fe(CN)_6$  in the supernatant solution.

*Adsorption of  $Na_4Fe(CN)_6$  by  $Cu_2Fe(CN)_6$  gel.* The adsorption of sodium ferrocyanide was determined by the same procedure described in the previous

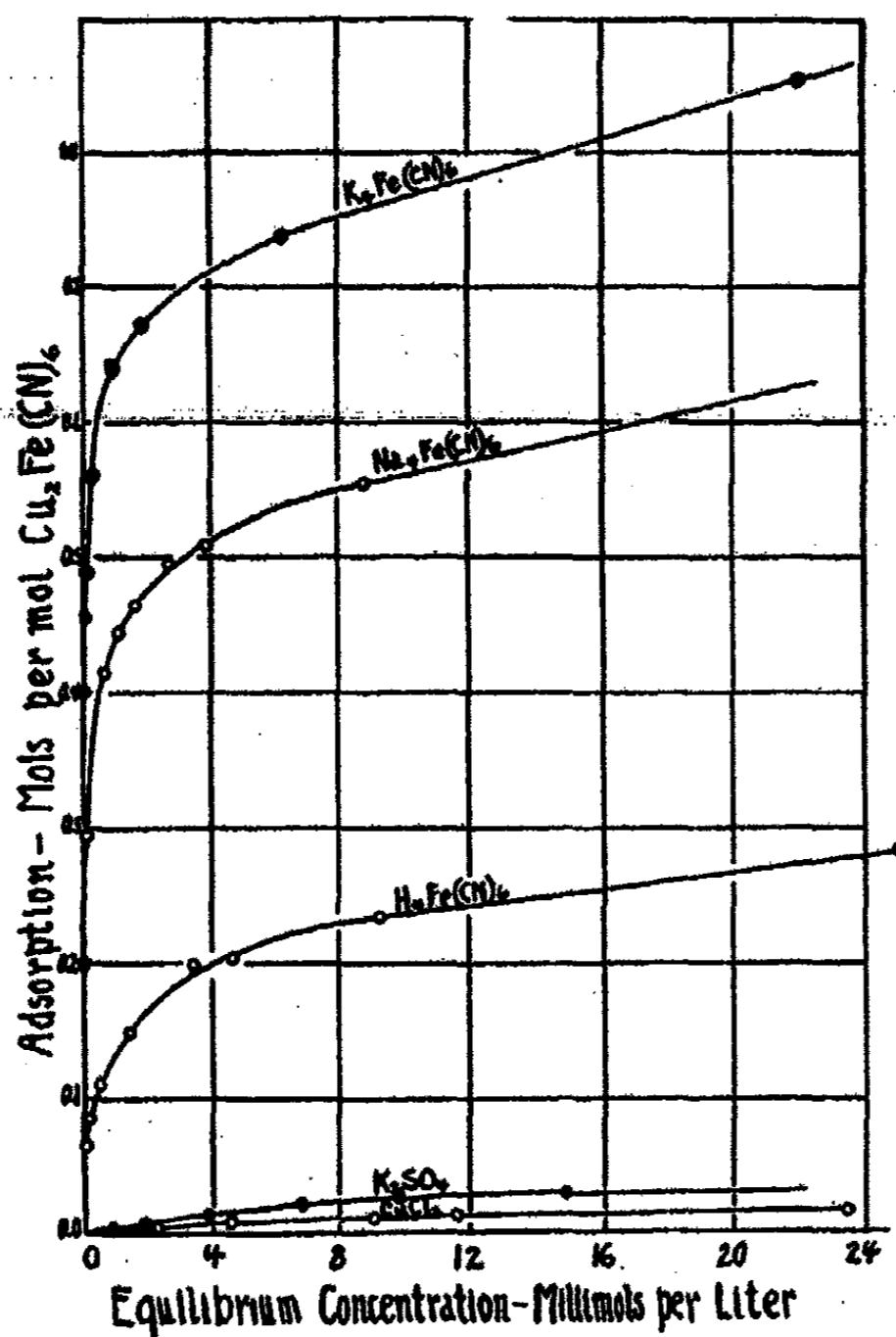

FIG. 2  
Adsorption by  $Cu_2Fe(CN)_6$

section. The results are given in Table III. The form of the adsorption isotherm is very similar to that of the corresponding potassium salt but the adsorption is appreciably less as indicated in Fig. 2.

*Adsorption of  $H_4Fe(CN)_6$  by  $Cu_2Fe(CN)_6$  gel.* It is claimed that pure copper ferrocyanide can be prepared by adding an excess of  $CuCl_2$  to  $H_4Fe(CN)_6$  solution.<sup>1</sup> This would indicate that  $H_4Fe(CN)_6$  is adsorbed by the gel much less strongly than the sodium or potassium salts. Such was found to be the case.

<sup>1</sup> Williams: "The Chemistry of Cyanogen Compounds" (1915).

TABLE III  
Adsorption of  $\text{Na}_4\text{Fe}(\text{CN})_6$  by  $\text{Cu}_2\text{Fe}(\text{CN})_6$

CuCl <sub>2</sub>	Solutions mixed (Total volume 250 cc) $\text{Na}_4\text{Fe}(\text{CN})_6$ 9.74 g per liter	Equilibrium concentration of $\text{Na}_4\text{Fe}(\text{CN})_6$ Millimols per liter	$\text{Na}_4\text{Fe}(\text{CN})_6$ adsorbed	
			gram per gram	mol per mol
100	60	0.0617	0.2632	0.2937
100	70	0.6336	0.3710	0.4139
100	75	1.0993	0.3977	0.4437
100	80	1.6260	0.4150	0.4630
100	90	2.7177	0.4439	0.4953
100	100	3.9313	0.4543	0.5069
100	140	8.7804	0.4969	0.5544

Hydroferrocyanic acid is somewhat difficult to work with since its solutions oxidize rapidly in the air and even when dissolved in oxygen-free water, it undergoes an internal oxidation-reduction reaction with the formation of Prussian Blue and the liberation of hydrocyanic acid. The pure stable crystals were obtained in the following way: Approximately 40 grams of potassium ferrocyanide were placed in a glass-stoppered bottle and dissolved in 200 cc of freshly boiled and cooled distilled water. To this was added slightly more than the equivalent amount of concentrated hydrochloric acid. If any KCl precipitated, it was dissolved by the addition of a small amount of water; 50 cc of cold ether was then added to the bottle which was stoppered and shaken gently with a whirling motion in order to bring the ether slowly in contact with the solution. By this procedure the hydroferrocyanic acid was precipitated as a coarse crystalline mass which was transferred rapidly to a Buchner funnel and washed with dilute hydrochloric acid containing a large amount of ether and, finally, with pure ether. When the crystals appeared dry they were placed on an unglazed plate in a vacuum desiccator over sulfuric acid. After evacuating with a water pump until most of the ether was removed, as high a vacuum as possible was maintained with an oil pump. When the product was thoroughly dry it was transferred to a glass-stoppered bottle which was kept in a vacuum desiccator. The acid formed in this way was almost white and was quite stable in the absence of moisture.

The adsorption of the acid by  $\text{Cu}_2\text{Fe}(\text{CN})_6$  gel was determined in the same way as the adsorption of its salts except that the precipitations and analyses were made as soon as possible after making up the  $\text{H}_4\text{Fe}(\text{CN})_6$  solution before marked decomposition of the acid had taken place. Ten-cubic-centimeters of N HCl in 250 cc were sufficient to prevent peptization of the gel. The results of the observations are given in Table IV and shown graphically in Fig. 2.

It will be noted that hydroferrocyanic acid is adsorbed much less than its salts by the copper ferrocyanide gel. The adsorption curve touches the x axis a relatively small distance above the origin. This suggests that a copper ferrocyanide membrane made by the action of  $\text{CuCl}_2$  and  $\text{H}_4\text{Fe}(\text{CN})_6$  may be slightly permeable to the acid. To test this, membranes were prepared

in parchment as previously described, replacing the hydroferrocyanic solution whenever it had taken on a deep blue color. After thorough washing, N/10 hydroferrocyanic acid solution was placed on the inside of the stoppered thimble and sugar solution on the outside. After several days during which the acid solution was changed repeatedly, a faint test for ferrocyanide ions was obtained in the sugar solution. It was impossible to carry out the experiments in a satisfactory manner because of the instability of the acid but the indications are that the membrane is but slightly permeable, if at all, to the acid.

*Adsorption of  $\text{CuCl}_2$  by  $\text{Cu}_2\text{Fe}(\text{CN})_6$  gel.* Walden<sup>1</sup> reported that copper ferrocyanide is impermeable to copper ion as well as the ferrocyanide ion. These observations were responsible for the quite generally accepted view that

TABLE IV  
Adsorption of  $\text{H}_4\text{Fe}(\text{CN})_6$  by  $\text{Cu}_2\text{Fe}(\text{CN})_6$

Solutions mixed (Total volume 250 cc)		Equilibrium concentration of $\text{H}_4\text{Fe}(\text{CN})_6$ Millimols per liter	$\text{H}_4\text{Fe}(\text{CN})_6$ adsorbed	
$\text{CuCl}_2$	$\text{H}_4\text{Fe}(\text{CN})_6$		gram per gram	mol per mol
100	50	0.0	0.0	0.0
100	53.3	0.0575	0.0360	0.0564
100	55	0.1270	0.0499	0.0784
100	60	0.5307	0.0700	0.1098
100	70	1.477	0.0950	0.1492
100	90	3.540	0.1272	0.1997
100	100	4.693	0.1299	0.2038
100	140	9.233	0.1493	0.2346
100	140	25.460	0.1797	0.2820

a gelatinous membrane is impermeable to its own ions. Tests with membranes supported in parchment thimbles disclosed that copper ferrocyanide is readily permeable to copper ion. Walden formed his membrane in gelatin and had the membrane-forming reagents on either side during his tests of permeability. It is probable that he failed to observe the passage of copper ion through the membrane because of his failure to remove all ferrocyanide which would react with the copper ion as fast as it came through.

Since copper ion passes through the membrane, it was of interest to compare the adsorption isotherm for a copper salt with that of a ferrocyanide. The procedure was the same as that previously used except that a constant amount of ferrocyanide (equivalent to 0.5 gm  $\text{Cu}_2\text{Fe}(\text{CN})_6$ ) was employed and the amount of  $\text{CuCl}_2$  was varied. An attempt was first made to use  $\text{K}_4\text{Fe}(\text{CN})_6$  but the adsorption of the salt is so strong that copper ion was always left over when  $\text{CuCl}_2$  and  $\text{K}_4\text{Fe}(\text{CN})_6$  were mixed in equivalent amounts.  $\text{H}_4\text{Fe}(\text{CN})_6$  solution was therefore employed. Copper ion was determined electrolytically after the copper chloride solutions were taken to

<sup>1</sup> Z. physik. Chem., 10, 699 (1892).

dryness and converted to sulfate with sulfuric acid. The results are given in Table V. It is clear that the adsorption is very small compared to that of hydroferrocyanic acid or its salts. (See Fig. 2) As we shall see, this is significant for the theory of the semipermeable membrane.

TABLE V  
Adsorption of  $\text{CuCl}_2$  by  $\text{Cu}_2\text{Fe}(\text{CN})_6$

Solutions mixed (Total volume 250 cc)		Cu remaining in 200 cc gram	Equilibrium concentration of $\text{CuCl}_2$ Millimols per liter	CuCl <sub>2</sub> adsorbed	
$\text{CuCl}_2$	$\text{H}_4\text{Fe}(\text{CN})_6$			gram per gram	mol per mol
55	50	0.0150	1.173	0.00	0.00
60	50	0.0291	2.290	0.0046	0.0044
70	50	0.0583	4.586	0.0090	0.0088
85	50	0.1029	8.092	0.0110	0.0108
100	50	0.1475	11.602	0.0130	0.0128
150	50	0.2970	22.543	0.0156	0.0154

Professor Hulett told me of his attempt to make a standard cell with approximately zero temperature coefficient according to the scheme:  $\text{Zn}/\text{ZnSO}_4//\text{CuSO}_4/\text{Cu}$ . An essential feature of the proposed cell was a membrane between the solutions consisting of a mixture of the ferrocyanides of zinc and copper which was expected to prevent the interdiffusion of the ions. The cell proved to be unsatisfactory since, as we now know, the ferrocyanides of zinc and copper are permeable to the respective cations.

*Adsorption of  $\text{K}_2\text{SO}_4$  by  $\text{Cu}_2\text{Fe}(\text{CN})_6$  gel.* Tammann<sup>1</sup> and Walden<sup>2</sup> claim that copper ferrocyanide is impermeable to alkali, alkaline earth, and heavy metal sulfates but is permeable to sulfuric acid. Tests carried out as previously described showed, however, that the membrane is permeable to the sulfates of potassium, sodium, copper, and magnesium; and it is probable that any sulfate will diffuse through.

The adsorption of sulfate was determined for a gel thrown down by the action of  $\text{CuCl}_2$  and  $\text{H}_4\text{Fe}(\text{CN})_6$  in the presence of potassium sulfate. The analyses were made gravimetrically as  $\text{BaSO}_4$ . The results are given in Table VI and plotted in Fig. 2. It will be seen that  $\text{K}_2\text{SO}_4$  is adsorbed slightly more than  $\text{CuCl}_2$  but very much less than hydroferrocyanic acid or its salts.

Walden's observation that sulfuric acid would diffuse through a ferrocyanide membrane but that its alkali salts would not, is but one example of a large group which he investigated. Thus he reports that the membrane is permeable to N/10 solutions of the following acids but not to the salts of the acids, formic, acetic, propionic, butyric, isobutyric, valerianic, cyanacetic, halogen acetic acids, glycolic, methyl- and ethyl glycolic, phenyl glycolic, di-glycolic, glyoxalic,  $\alpha$  and  $\beta$  oxypropionic, glyceric,  $\alpha$  and  $\beta$  oxybutyric, meta and para oxybenzoic, quinic, tartaric, citric, mandolic,  $\alpha$ -nitrophthalic,

<sup>1</sup> Z. physik. Chem., 10, 255 (1892).

<sup>2</sup> Z. physik Chem., 10, 489 (1892).

mellitic, tetracarbonic, dimethyl malonic, quinolinic, sulfanilic, methylenedisulfonic, quinolinesulfonic, xylene-, benzene-, pseudocumene-, and naphthalene sulfonic acids, sulfuric, chromic, dimethyl phosphoric, phosphoric, arsenotungstic, phosphotungstic, arsenomolybdic, borotungstic, acrylic, caproic, and colloidal tungstic acid.

There appears to be no good reason why the acids should diffuse through the membrane and not the alkali salts. Bancroft and Gurchot<sup>1</sup> believe that

TABLE VI  
Adsorption of  $K_2SO_4$  by  $Cu_2Fe(CN)_6$

$K_2SO_4$ added 0.05 molar	$BaSO_4$ in 200 cc	Equilibrium concentration of $K_2SO_4$ Millimols per liter	$K_2SO_4$ adsorbed	
			gram per gram	mol per mol
5	0.0465	0.996	0.00046	0.0009
10	0.0918	1.965	0.0030	0.0058
20	0.01830	3.932	0.0072	0.0139
35	0.3206	6.868	0.0114	0.0224
50	0.4595	9.844	0.0138	0.0267
100	0.6924	14.835	0.0148	0.0288

the acids may have a coagulating action on the membrane which will render it permeable; but it is more probable that Walden's observations are open to question owing to the limitations of his experimental method. Certainly this is the case with sulfuric acid and the sulfates. Walden placed potassium ferrocyanide containing sensitive blue litmus on one side of a membrane formed in gelatin, and copper sulfate with N/10 solutions of the acids on the opposite side, and noted whether or not the blue litmus turned red within an hour. That it did with the acids investigated is what one might expect since the tendency to set up a Donnan equilibrium would cause the rapidly moving hydrogen ion to pass through the membrane and turn the litmus. No such test was available when the sodium salts were employed and so they were reported as not diffusing. It is obvious that Walden observed the diffusion of hydrogen ion and not of the anions. His experiments tell us only that the degree of ionization of the acid employed was such that in one hour sufficient hydrogen ion diffused through the membrane to change a part of the litmus from blue to red.

Further doubt is thrown on the accuracy of Walden's experimental method by the observation that sufficient colloidal  $MoO_3$  passed through the membrane in an hour to give the molybdenum blue test on reduction with zinc. While it may be that the particles of colloidal  $MoO_3$  are small enough to pass a well-formed membrane if sufficient time is allowed, it is unlikely that any appreciable amount would go through in an hour unless the membrane was defective.

<sup>1</sup> J. Phys. Chem., 28, 1279 (1924); 30, 83 (1926).

While Walden's data are not satisfactory, it is likely that most, if not all, of the above-mentioned acids as well as their alkali salts will pass through a copper ferrocyanide membrane if sufficient time is allowed. A preliminary test showed that in ten days both phosphomolybdic acid and sodium phosphomolybdate had passed through a membrane into isotonic sugar solution, in sufficient amount to give a distinct molybdenum blue test. The membranes employed were found to be impermeable to potassium ferrocyanide both before and after the experiments with phosphomolybdate. Since alkali phosphomolybdate molecules are very large compared to alkali ferrocyanide, the impermeability of copper ferrocyanide to the latter is clearly not a question of pore size. Preliminary observations showed that phosphomolybdate is weakly adsorbed by copper ferrocyanide gel.

#### Discussion of Results

A membrane, which may be regarded as continuous as distinct from porous, will be permeable to the solvent and not to the solute if the former dissolves in the membrane and the latter does not. A distinctly porous membrane will be permeable to the solvent and not to the solute if it exhibits such marked negative adsorption that the pore walls are covered with a film of pure solvent and if the pores are sufficiently fine that the adsorbed film fills the pores full. An example of the first class is rubber which is highly permeable to benzene, toluene, and pyridine, which are readily soluble in it, and almost impermeable to water which is but slightly soluble in it. An example of the second class is copper ferrocyanide which is permeable to water but not to sugar.

The copper ferrocyanide membrane is impermeable to potassium and sodium ferrocyanide and but slightly permeable, if at all, to hydroferrocyanic acid. This is not due to strong negative adsorption as in the case of sugar solution. On the contrary, the adsorption of ferrocyanides by copper ferrocyanide gel is unusually great. Thus in the case of potassium ferrocyanide the adsorption by the freshly formed gel is so strong that it is practically irreversible between 0 and 0.4 mol of  $K_4Fe(CN)_6$  per mol of  $Cu_2Fe(CN)_6$ . Therein lies the explanation of the impermeability of the membrane to ferrocyanide. The adsorption is so strong that the fixed walls of the pores hold chains of oriented ferrocyanide molecules extending from a monomolecular film on the surface throughout the pore solution. The practically irreversibly adsorbed ferrocyanide is sufficient to saturate the pore water with the salt. The condition is represented diagrammatically in Fig. 3 in which the dark circles represent ferrocyanide molecules. Since the solution in the pores is saturated with the adsorbed salt, no more ferrocyanide can enter from the side of the membrane in contact with the solution; and since the adsorption necessary to saturate the pore solution is practically irreversible, ferrocyanide will not pass into water or sugar solution on the opposite side. The result is that the membrane will be impermeable to the solute but not to the solvent.



Turning to copper chloride and potassium sulfate, we find that these salts are likewise adsorbed by copper ferrocyanide gel, but the membrane is permeable to them, nevertheless. The reason is that copper chloride and potassium sulfate are adsorbed very much less strongly than the ferrocyanides. Moreover, the relatively weak adsorption of the former salts is practically completely reversible throughout the entire range. Since the adsorption is insufficient to saturate the solvent in the pores and since the adsorption is reversible, copper chloride and potassium sulfate will diffuse through the membrane. Between one extreme, that of potassium ferrocyanide which will not pass the membrane owing to strong adsorption which is irreversible throughout a certain range, and the other extreme, that of copper chloride which passes the membrane because of relatively weak adsorption which is completely reversible, there are an indefinite number of gradations in the degree of permeability as a result of positive adsorption. The copper ferrocyanide membrane should be more permeable to hydroferrocyanic acid than its alkali salts but the instability of solutions of the acid makes it difficult to carry out comparative tests. At quantitative study is now being made

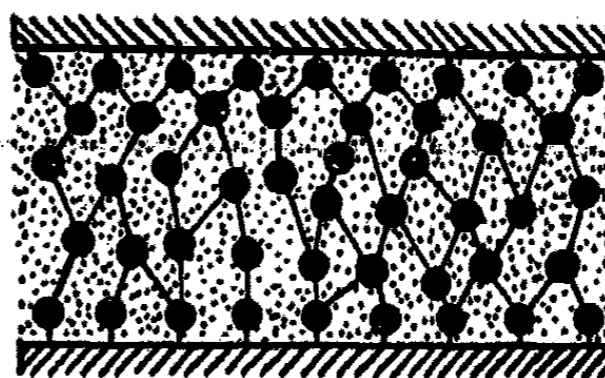

FIG. 3

Diagrammatic Representation of a Portion of a Pore in a  $\text{Cu}_2\text{Fe}(\text{CN})_6$  Membrane in which the Pore Water is saturated with Adsorbed  $\text{K}_4\text{Fe}(\text{CN})_6$ .

of the relationship between the permeability of a membrane for salts and the adsorption of the salts by the membrane. In this connection Hartung<sup>1</sup> reports that potassium chloride is adsorbed by copper ferrocyanide less strongly than is potassium sulfate and that the former diffuses through the membrane more rapidly than the latter. This appears to be in accord with what one might expect.

The adsorption of the ferrocyanides by copper ferrocyanide is in the order:  $\text{K}_4\text{Fe}(\text{CN})_6 > \text{Na}_4\text{Fe}(\text{CN})_6 > \text{H}_4\text{Fe}(\text{CN})_6$ . It seems probable that the variation in adsorption is due to the difference in hydration of the respective cations. If one accepts Fajans'<sup>2</sup> view that the hydration of an ion consists in the formation of a polarized water envelope, the process being accompanied by a positive heat effect, one should expect the adsorption to be accompanied by a partial dehydration, the extent of which will be determined by the heat of hydration of the ions. Since the heat of hydration and the amount of hydration decreases in the alkali series from lithium to caesium, it would follow that the adsorption would decrease in the reverse order. Actually we find the adsorption of potassium ferrocyanide to be much greater than that of the more highly hydrated sodium salt. If this is the important factor in determining the order of adsorption of the ferrocyanides it would follow that

<sup>1</sup> Trans. Faraday Soc., 15, (3), 160 (1920).

<sup>2</sup> Naturwissenschaften, 37, 1 (1921).

hydrogen ion is more highly hydrated than the alkalies. This is in line with the views of Fajans,<sup>1</sup> Bjerrum<sup>2</sup> and Schreiner<sup>3</sup>.

In conclusion, a distinctly porous membrane will be semipermeable under two conditions: (1) if the membrane exhibits such marked negative adsorption for the solute that the pore walls are covered with a film of pure solvent which completely fills the pores; and (2) if the positive adsorption of the solute is sufficiently great to saturate the solution in the pores within the range that the adsorption is practically irreversible.

### Summary

The results of this investigation may be summarized briefly as follows:

1. A porous membrane will be permeable to the solvent and not to the solute if it exhibits such marked negative adsorption that the pore walls are covered with a film of pure solvent and if the pores are sufficiently fine that the adsorbed film fills the pores full (Bancroft). Thus copper ferrocyanide membrane is permeable to water but not to sugar because of strong negative adsorption.

2. A copper ferrocyanide membrane is impermeable to alkali ferrocyanides and but slightly permeable, if at all, to hydroferrocyanic acid. This is not due to negative adsorption by the membrane and is not the result of a sieve action.

3. Copper ferrocyanide gel adsorbes ferrocyanides very strongly. The adsorption of potassium ferrocyanide by the freshly formed gel is so great that it is practically irreversible between 0 and 0.4 mol of adsorbed  $K_4Fe(CN)_6$  per mol of  $Cu_2Fe(CN)_6$ .

4. The explanation of the impermeability of copper ferrocyanide to ferrocyanides is as follows: The adsorption of ferrocyanide is so strong that the fixed walls of the pores hold chains of oriented ferrocyanide molecules extending from a monomolecular film on the surface throughout the pore solution. The practically irreversibly adsorbed ferrocyanide is sufficient to saturate the pore water with the salt. Since the solution in the pores is saturated with the adsorbed salt no more ferrocyanide can enter from the side of the membrane in contact with the solution and since the adsorption necessary to saturate the pore solution is practically irreversible, ferrocyanide will not pass into water or sugar solution on the opposite side. The result is that the membrane will be impermeable to the solute but not to the solvent.

5. The order of adsorption of ferrocyanides by copper ferrocyanide is:  $K_4Fe(CN)_6 > Na_4Fe(CN)_6 > H_4Fe(CN)_6$ . This is the order of increasing hydration of the cations.

6. Copper ferrocyanide is permeable to potassium sulfate and copper chloride. These salts are adsorbed relatively weakly by copper ferrocyanide gel and the adsorption is reversible.

<sup>1</sup> Naturwissenschaften, 37, 1 (1921).

<sup>2</sup> Z. anorg. Chem., 109, 275 (1920).

<sup>3</sup> Z. anorg. Chem., 135, 333 (1924).

7. Copper ferrocyanide is permeable to the large molecules of sodium phosphomolybdate and phosphomolybdic acid. These compounds are weakly adsorbed by copper ferrocyanide gel.

8. Walden's claim that copper ferrocyanide is in general permeable to acids, but not to their sodium salts is erroneous owing to the limitation of the experimental method he employed.

9. A distinctly porous membrane such as copper ferrocyanide will be completely semipermeable under two conditions: (1) if the membrane exhibits such marked negative adsorption for the solute that the pore walls are covered with a film of pure solvent which completely fills the pores; and (2) if the positive adsorption of the solute is sufficiently great to saturate the solution in the pores within the range that the adsorption is practically irreversible. Between the two extreme conditions which produce semipermeability, there are an indefinite number of gradations in degree of permeability of a membrane for a dissolved solute.

*Department of Chemistry,  
The Rice Institute,  
Houston, Texas.*

22-11  
THE OPTIMUM CONDITIONS FOR THE FORMATION OF SILICA  
GEL FROM ALKALI SILICATE SOLUTIONS. PART I.

BY R. C. RAY AND P. B. GANGULY

The capacity of dried silicic acid to adsorb various vapours and even to remove certain substances from solutions was first observed by van Bemmelen<sup>1</sup> in 1897. Marcus<sup>2</sup> showed that silica gel could be used as an adsorbent in taking up considerable quantities of undesirable constituents from gasses and liquids. Patrick<sup>3</sup> and his co-workers<sup>4</sup> improved the methods of preparing, drying, and activating silica gel, and studied its use for the separation and recovery of different vapours and gases. Although this material has received considerable application on an industrial scale, it appears that the exact conditions under which the gel is best formed have not been described.

The only systematic published work on the subject is due to Flemming,<sup>5</sup> where different concentrations of sodium silicate solutions have been titrated in order to determine the optimum conditions for gel formation. He determined mainly the time required for setting by mixing a solution of sodium silicate with that of hydrochloric acid at different temperatures, and found that the rate of setting increases with rise in temperature and with increasing concentration of the silicate solution. As the concentration of hydrogen ions increases the coagulation is said to be retarded first and then accelerated, the reverse being the case when the concentration of hydroxyl ions is increased. It should be mentioned here that we have been unable to confirm the observation of Flemming, that gel formation is accelerated when a large excess of acid is added to a sodium silicate solution.

There is no doubt, however, that hydrogen ion concentration exerts a very marked influence on the process of gel formation. The titration method used by Flemming does not allow a quantitative determination of the influence of hydrogen and hydroxyl ion concentration accurately. It was, therefore, considered worth while to make a thorough quantitative investigation on this subject. Moreover, our results differ from those of Flemming in certain respects.

The formation of silica gel from alkali silicate solutions is influenced by a number of factors. Temperature, concentration of the silicate solutions, stirring, as well as light, have each a marked influence on the rate of formation of the gel. The most important factor, however, is the relative concentration

<sup>1</sup> Z. anorg. Chem., 13, 296 (1897).

<sup>2</sup> British Patents, 17873 (1911); 25220 (1912); German Patents, 263388, 268057 (1912); 279075, 283882 (1913); French Patent, 465569 (1913).

<sup>3</sup> Göttingen thesis (1914).

<sup>4</sup> J. Am. Chem. Soc., 42, 946 (1920); 44, 1 (1922); Chem. Met. Eng., 23, 1155 (1920); U. S. A. Patents, 1297724 (1919); 1335348 (1920); British Patents, 136543, 137284 (1919); 159508 (1921); Canadian Patents, 200912 (1920); 217365 (1922).

<sup>5</sup> Z. physik. Chem., 41, 427 (1902).

of the silicate solution and of the solution used to produce the gel. Thus when hydrochloric acid is used, for any definite concentration of the alkali silicate solution, there are two well-defined limiting values for the concentration of hydrochloric acid that will cause gelation. One of these limits occurs when the resulting solution is just acidic and the further addition of the slightest excess of hydrochloric acid, beyond this concentration, completely prevents gel formation even though the solution be kept for weeks. The other limit is reached when the resulting solution is fairly alkaline, gelation being produced by the addition of a further small quantity of acid. The solution does not set if the amount of acid added is less than this limiting quantity.

Two solutions of alkali silicates were prepared, one from a sample of syrupy sodium silicate and another from potassium silicate (Kahlbaum's solid potassium meta-silicate). Both the solutions were free from iron and contained only traces of aluminum as impurity. Definite volumes of these solutions were analysed quantitatively and the ratios,  $\text{Na}_2\text{O}:\text{SiO}_2$  and  $\text{K}_2\text{O}:\text{SiO}_2$  determined. The solutions were then titrated against standard hydrochloric acid, using methyl orange as an indicator. The titration values were employed as a rough index in varying the quantities of hydrochloric acid added to a definite volume of the silicate solutions.

Definite quantities of the silicate solutions were taken in test tubes to which varying amounts of hydrochloric acid were added, and the total volume made up to a fixed value by the addition of the requisite amount of water. The liquids were intimately mixed, kept at a constant temperature, securely stoppered to prevent the action of atmospheric carbon dioxide, and left for about 24 hours. It was found that the mixture in certain of the tubes had set to a hard gel, while others remained quite transparent and mobile. There was for each concentration of the silicate solution a definite range, beyond which no gelatin occurred. The pH values corresponding to the points where gel formation just stopped were accurately measured. A typical series of experimental results are given in Tables I-II.

TABLE I

Analysis of the sodium silicate solution: 81.55 grms of  $\text{Na}_2\text{O}$   
and 178.10 grms of  $\text{SiO}_2$  per litre. Ratio  $\text{Na}_2\text{O}:\text{SiO}_2 = 1:2.25$ .

Vol. of silicate solution	Vol. of N/2.25-HCl used	Vol. of water added to make total vol. 15 c.c.	pH	Observations
2 c.c.	12.15 c.c.	0.85 c.c.	—	Remains clear
2 c.c.	12.10 "	0.90 "	2.81	Remains clear
2 "	12.05 "	0.95 "	—	Sets to hard gel
2 "	6.85 "	6.15 "	—	Sets to a gel
2 "	6.80 "	6.20 "	10.62	Remains clear
2 "	6.75 "	6.25 "	—	Remains clear

TABLE II  
Analysis of potassium silicate solution: 207.04 grms of  $K_2O$   
and 132.38 grms of  $SiO_2$  per litre. Ratio  $K_2O:SiO_2 = 1:1$ .

Vol. of silicate solution	Vol. of N-HCl added	Vol. of water added to make total vol. 15 c.c.	pH	Observations
2 c.c.	8.95 c.c.	4.05 c.c.	—	Clear
2 "	8.90 "	4.10 "	2.73	Clear
2 "	8.85 "	4.15 "	—	sets to a gel
2 "	6.15 "	6.85 "	—	sets to a gel
2 "	6.10 "	6.90 "	11.6	Clear
2 "	6.05 "	6.95 "	—	Clear

The results given in the above table indicate how the two limiting pH values corresponding to a particular concentration of the alkali silicate solution are found out. Thus it will be seen from Table I, that, for the particular concentration of sodium silicate solution, the mixed solution sets to a gel only when it contains less free hydrochloric acid than that corresponding to a pH value of 2.81, or when it contains free alkali less than that corresponds to a pH value of 10.62. After these pH values are reached the solutions will never set, however long it may be kept. A large series of experiments were carried out in the same manner in order to determine the pH values for the range of gel formation, for different concentrations of the silicate solutions. The results obtained are tabulated in Tables III-IV.

TABLE III  
Showing the region of gel formation for sodium silicate solutions of different concentrations

Mols $SiO_2$ per litre	Limiting pH (Acid side)	Limiting pH (Alkali side)
0.791	2.65	10.75
0.593	2.71	10.59
0.395	2.81	10.62
0.228	3.63	9.95
0.147	4.22	9.59
0.074	4.99	8.20
0.049	5.48	7.95

TABLE IV  
Showing the region of gel formation for potassium silicate solutions of different concentrations.

Mols $SiO_2$ per litre	Limiting pH (Acid side)	Limiting pH (Alkali side)
0.441	2.34	11.71
0.294	2.73	11.60
0.147	3.50	10.85
0.074	4.71	9.64
0.037	5.72	8.41

The range of gel formation for the two alkali silicate solutions is represented in Fig. 1, where the concentrations of the silicate solutions, expressed in terms of mols  $\text{SiO}_2$  per litre, have been plotted against the limiting pH values. It will be noticed that the general shape of the two curves is very similar. It is very remarkable that the curves are, more or less, symmetrically placed with respect to the abscissa corresponding to the neutral point. Thus we find that a solution will set when there is either an excess of hydrogen

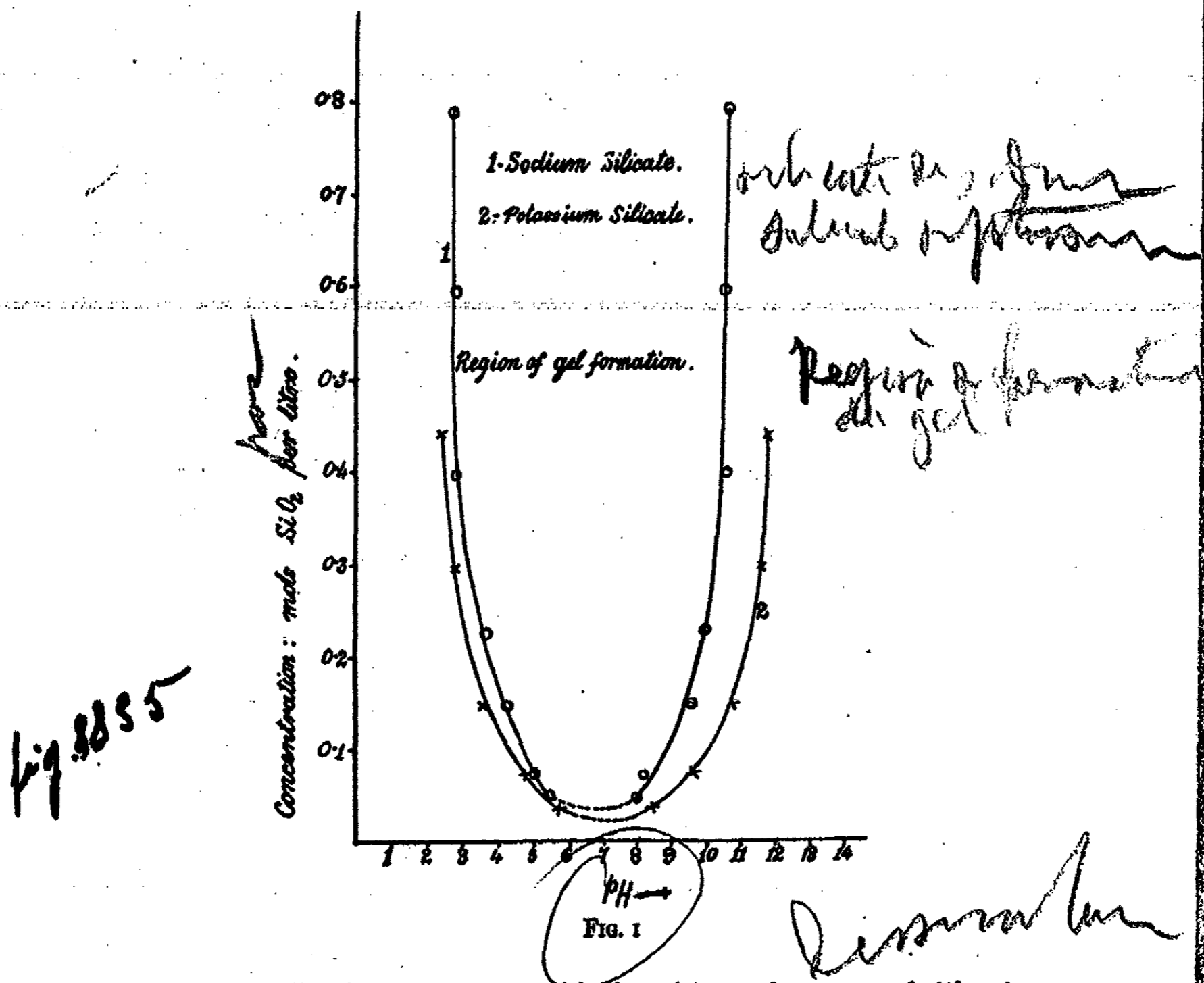

ions or practically the same excess of hydroxyl ions, the excess of either ion being within the limits as shown in the curves. Even with dilute concentrations of alkali silicate solutions gel formation always takes place when the resulting solution is neutral, that is, has a pH equal to 7. Titration with the help of an indicator like methyl orange is not always suitable for the determination of the relative concentrations of acid and a silicate solution that will produce gelation, because, what appears neutral to methyl orange is actually acidic.

By means of the simple arrangement shown in Fig. 2, silica gel may be prepared easily even from the very dilute solutions of sodium silicate. Sodium silicate solution is taken in a suitable vessel and hydrochloric acid is added

TABLE V

Concentration; mols $\text{SiO}_2$ per litre	Experiments with Sulphuric acid		Experiments with Hydrochloric acid	
	pH(acid range)	pH(alkali range)	pH(acid range)	pH(alkali range)
0.396	2.75	10.48	2.81	10.62
0.228	3.62	9.62	3.63	9.95
0.074	4.76	8.26	4.99	8.20

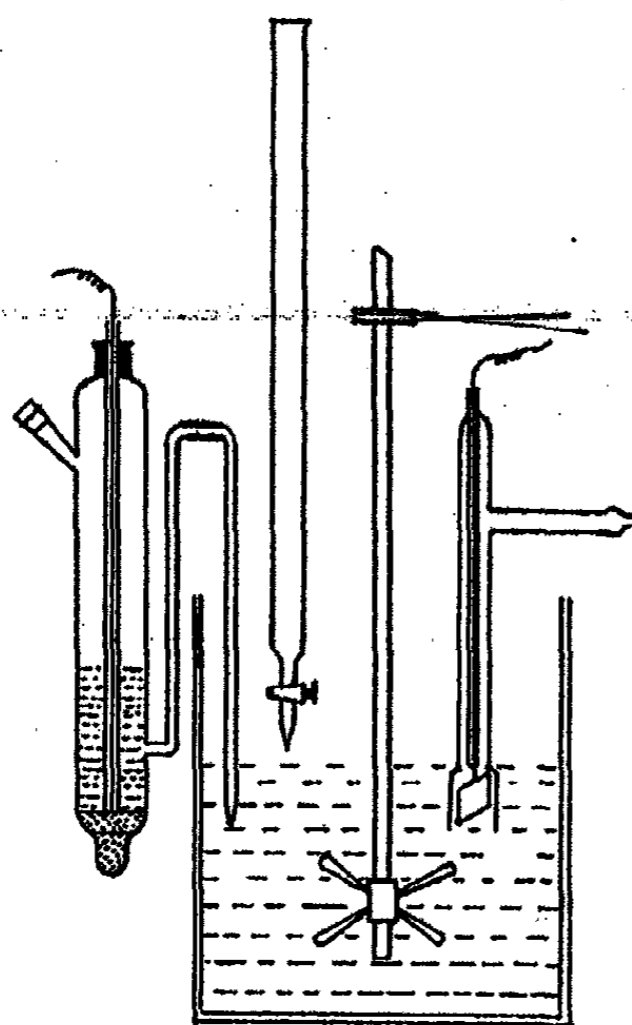

Fig. 2

with constant stirring until the pH attains a value, which falls within the region of gel formation as shown in Fig. 1. Several samples of gel were prepared in this manner and the method was found to be satisfactory.

The sodium silicate solution gave on analysis the ratio  $\text{SiO}_2:\text{Na}_2\text{O}$  as 2.25:1, whereas in the case of potassium silicate the ratio  $\text{SiO}_2:\text{K}_2\text{O}$  was exactly as 1:1. It will be noticed that the region of gel formation, as shown by the curves, is practically the same in the case of both the silicate solutions. The slight difference between the two regions is probably due to the effect of neutral salts, which are not the same in both the cases.

In another series of experiments attempts were made to determine whether the region of gel formation remained the same when sulphuric acid was substituted for hydrochloric acid.

Proceeding in the same manner as in the experiments with hydrochloric acid a series of values for the pH ranges has been obtained with sulphuric acid. Some of the results are given in Table V.

It will be seen from these results that there is practically no change for the pH values when sulphuric acid is substituted for hydrochloric acid. It must be mentioned, however, that there is one important difference between the two acids regarding their power of gel formation. In the case of hydrochloric acid, the region of gel formation is quite sharp. In the case of sulphuric acid, however, several solutions, which did not set after 24 hours, when kept for a longer period, became turbid and finally viscous. In some cases there was no continuous gel formation, but a precipitate of silicic acid was produced on standing. Thus it is clear that it is not possible to determine the region of gel formation, in the case of sulphuric acid as definitely as when hydrochloric acid is used. It appeared that this effect was probably due to



the presence of sodium sulphate generated in the system. In order to find out if this was really the case, a series of experiments was carried out in which varying amounts of a solution of sodium sulphate were added to a solution of sodium silicate and the requisite amounts of hydrochloric acid were added to the mixtures. The same kind of irregularities, as shown in the case of sulphuric acid was also observed in a more marked manner in this case.

Ultraviolet light has been found to have a distinct accelerating influence on the rate of setting of a silica gel. The same solution was exposed side by side before a mercury lamp in two tubes, one of which was completely wrapped in black paper. The uncovered tube was found to set about ten minutes before the covered one, the total time of setting being about ninety minutes.

Holmes and Anderson<sup>1</sup> have prepared silica gel by adding a solution of ferric chloride to a solution of sodium silicate. When ferric chloride solution is added to a solution of sodium silicate a yellowish gelatinous precipitate is formed on the addition of each drop until a maximum amount of precipitate is obtained. Holmes and Anderson suggest that the gelatinous precipitate does not contain ferric silicate, because an X-ray study of the dried precipitate failed to indicate any crystalline structure. They admit, however, that the evidence is not conclusive. Jordis and Hennis<sup>2</sup> have shown that the reaction between ferric chloride and sodium silicate solutions is a complicated one. Yellow ferric silicate is formed as one of the constituents, and permanent changes are produced on heating. Liesegang<sup>3</sup> considers that when a solution of ferric chloride is dropped into a solution of sodium silicate, gelatinous precipitates of ferric silicate are produced, but when a solution of ferric chloride is allowed to diffuse through an aqueous solution of sodium silicate, a thin wrinkled skin, which consists of silicic acid irregularly streaked with ferric hydroxide, is formed.<sup>4</sup>

We have studied the formation of silica gel by the action of ferric chloride on sodium silicate. Immediately on the addition of sodium silicate, a gelatinous yellow precipitate is formed, which continues as further quantities of ferric chloride solution are added until a maximum amount of precipitate is produced. The precipitate does not usually set to a hard gel at 25°C. If the temperature is raised, however, to 60°C, solutions which contain an amount of ferric chloride equivalent to the amount of sodium silicate taken set to a hard gel in a period of about 3-6 hours. Solutions containing an excess of free ferric chloride, when raised to a temperature of 60°C, do not set, but turn deep red in colour and dissolve most of the precipitate originally formed.

These observations may be best explained by supposing the following reaction between ferric chloride and sodium silicate solutions. In the first instance a precipitate of ferric silicate is formed. This is partially hydrolysed, producing ferric hydroxide and silicic acid. When the temperature is raised the iron silicate hydrolyses further, generating silicic acid, which then sets to

<sup>1</sup> Ind. Eng. Chem., 17, 280 (1925).

<sup>2</sup> J. prakt. Chem., (2) 77, 238 (1908); 81, 289 (1910).

<sup>3</sup> Kolloid-Z., 9, 289 (1911).

<sup>4</sup> Liesegang: J. prakt. Chem., (2) 88, 358 (1913).

a hard gel, whereas at the ordinary temperature the hydrolysis is not complete and rapid enough to produce the gel. When the mixtures contain an excess of free ferric chloride a part of the ferric hydroxide and ferric silicate passes into colloidal form, being peptised by the excess of free ferric chloride. Consequently no gel is obtained, but a deep red colored solution is produced. Further work is still in progress.

#### Summary

1. The optimum conditions for the formation of silica gel by the action of hydrochloric acid, sulphuric acid, and ferric chloride on alkali silicate solutions have been studied. It has been found that hydrogen ion concentrations play a fundamental role in the process of gel formation.

2. For each concentration of the alkali silicate solution, there is a limiting range of pH values in which gel formation takes place. The region of gel formation has been accurately determined.

3. A convenient arrangement for producing silica gels from dilute silicate solutions has been described.

4. It has been found that when sulphuric acid is used, the region of gel formation, is not sharply demarcated. This has been found to be due mainly to the presence of sodium sulphate. Slight variations in the curve for gel formation is also produced when sodium chloride is substituted for potassium chloride.

5. It has been found that ferric chloride solutions do not produce gelatin readily at the ordinary temperature, but give a gel at 60°C. Excess of ferric chloride does not produce a gel even at high temperatures, but dissolves a part of the precipitate originally formed. These observations have been satisfactorily explained on the basis of the formation of ferric silicate in the first instance.

*Chemical Laboratory,  
Science College, Patna.*

## STUDIES ON PHOSPHORIC ACID\*

### I. The Decomposition of Formic Acid by Means of Phosphoric Acid

BY JAMES H. WALTON AND HENRY M. STARK

Phosphoric acid as a dehydrating agent for certain organic compounds possesses the distinct advantages of not acting as an oxidizing agent during the process of dehydration and of not charring the reactants. On the other hand it requires a much higher temperature than sulfuric acid. In spite of the fact that phosphoric acid has been used for a long time no systematic investigation has been made on the kinetics of the reactions in which this acid acts as a dehydrating agent. Further, no attempt has been made to systematically study the effects of the ortho, the pyro, and the meta acids. In using phosphoric acid for dehydration the procedure followed has been distinctly empirical as evidenced by the fact that the method usually followed is to heat the 85 percent solution of ortho phosphoric acid until a concentrated solution sufficiently active for the purpose in hand is obtained. No evidence of the composition of this product is available.

This investigation was carried out with the object of studying the dehydrating action of the different phosphoric acids on formic acid, according to the equation  $\text{HCOOH} = \text{H}_2\text{O} + \text{CO}$ . Similar studies made on the dehydrating action of sulfuric acid on such compounds as formic,<sup>1</sup> malic<sup>2</sup> and triphenyl<sup>3</sup> acetic acids have yielded valuable information on the mechanism of sulfuric acid dehydrations and the conditions influencing such reactions.

#### Experimental

*Materials.* All the chemicals used in this work were the purest obtainable. The phosphoric acid was prepared from a good grade of the 85 percent sirupy acid, three samples prepared as follows being used in these experiments.

Sample A. The acid was evaporated slowly in a large evaporating dish the temperature being gradually increased until after a period of three or four hours it reached 250°. It was held at this temperature for thirty minutes after which it was transferred to a glass-stoppered bottle and used as a stock solution. This sample contained 90.3% ortho acid, and 5.1% of the meta plus the pyro acids.

Sample B. The 85 percent acid was concentrated under a pressure of 30-40 mm. at a temperature of 100°-105°. The resulting acid contained 94.6% ortho-phosphoric acid and gave no test for the pyro or meta forms.

Sample C. This was pure crystalline ortho phosphoric acid prepared by Dr. E. O. Wiig of this laboratory.

\* Contribution from the Laboratory of General Chemistry, University of Wisconsin.

<sup>1</sup> Schierz: J. Am. Chem. Soc., 45, 447 (1923).

<sup>2</sup> Whitford: J. Am. Chem. Soc., 47, 953 (1925).

<sup>3</sup> Dittmar: J. Phys. Chem., 23, 533 (1929).

*Apparatus and Method.* The reaction was carried out in a two-necked Pyrex flask of 100 cc. capacity. One neck of the flask carried a mercury seal which permitted the contents of the flask to be stirred while the whole system was closed. The other neck of the flask was provided with a stopper carrying a capillary tube that was connected with a water-jacketed gas burette. In the experiments to be described the procedure was as follows: 40 cc. of phosphoric acid was placed in the flask together with a few glass beads or short glass rods the object of which was to act as baffle plates during the stirring, thereby helping to relieve the supersaturation of the solution with respect to the gas formed. The stirrer was put in place and the flask then placed in a thermostat which was operated at 120° unless otherwise specified. After the contents of the flask had reached the temperature of the bath a small capsule containing the substance to be dehydrated was dropped into the flask through the side neck that led to the burette, the stopper was then quickly inserted, and readings on the gas burette were taken at definite time intervals giving the speed of dehydration of the formic acid.

Inasmuch as sodium formate is easy to purify and weigh out and also yields formic acid with excess of phosphoric acid, it was used in these experiments instead of pure formic acid.

*Completeness of the Reaction.* That sodium formate in the presence of excess phosphoric acid yields formic acid which is quantitatively decomposed into water and carbon monoxide is evidenced by the following data: Four portions of sodium formate were weighed out, added to phosphoric acid and the resulting volumes of carbon monoxide gas were measured. The calculated volumes of gas in cc. were 37.8, 37.4, 37.8, and 50 respectively. The observed volumes were 37.7, 36.8, 38.0, and 49.5 cc.

In measuring the speed of the reaction it was found that an induction period existed and that satisfactory constants were obtained only when the zero point was taken after 15-25 percent of the sample had decomposed. These constants, which are for a unimolecular reaction, are sufficiently concordant as shown by the following data:

Time in Min.	4	5	6	7	8	10
Veloc. const. $k \times 10^3$	258	260	256	257	258	253

Additional evidence that the reaction over the greater part of its period conforms to the unimolecular type is given by the fact that a variation in the amount of phosphoric acid used did not alter the value of the velocity constant. Reaction velocity measurements made when 50, 40 and 25 cc. of

TABLE I.

Temperature Coefficients—Acid A with HCOONa

Temp.	$k \times 10^3$	Temp. Coeff.	Temp.	$k \times 10^3$	Temp. Coeff.
100	65.2		120	228	1.88
110	121.0	1.86	130	409	1.78

phosphoric acid was used with the same quantity of sodium formate gave identical velocity constants.

*Temperature Coefficient.* The effect of temperature on the reaction is shown in Table I.

*Effect of Different Preparations of Phosphoric Acid.* In the beginning of this investigation an attempt was made to use ordinary syrupy phosphoric acid for the dehydration, but five or six hours were required for the reaction to take place, and complete decomposition of the formic acid was never obtained. At the temperature of  $120^{\circ}$ , moreover, water vapor was given off, which condensed and interfered with the measurement of the gas evolved. For this reason and also because of its more rapid rate of reaction, the concentrated mixture of acids (acid A) was used in the major portion of this work. The effect of the kind and concentration of acid used is shown in Table II.

TABLE II  
Effect of Different Acids on Reaction Rate

Acid used	$k \times 10^3$	Acid used	$k \times 10^3$
Ordinary syrupy (85% ortho)	2-4	Acid A (90.3% ortho)	274
Acid B (94.6% ortho)	20.6	Pure pyro acid	121
100% ortho acid	72.1		

*Effect of Water on the Reaction Rate.* Since water is formed as a result of the action of phosphoric upon formic acid, the effect of its addition becomes of considerable importance from the viewpoint of its effect on this reaction and also in the comparison of the relative dehydrating properties of sulfuric and phosphoric acids of different concentrations. Table III gives the results obtained by adding water in varying amounts to a fixed concentration of the concentrated acid (acid A).

TABLE III  
Effect of Addition of Water to Reaction Mixture

Amt. of water added (cc. per 250 cc.)	%H <sub>2</sub> O present	Molality of water	$k \times 10^3$	$k \times 10^3$ (H <sub>2</sub> SO <sub>4</sub> )
none	4.61	2.68	274	99
0.5	4.61	2.76	274	99
1	4.86	2.84	235	89
2	5.22	3.16	225	79
4	5.62	3.31	196	68
6	6.13	3.63	159	54
10	7.34	4.39	94	24

Table III shows that water is very effective in retarding the dehydration reaction. The effect of water in decreasing the velocity constant of the reaction of H<sub>3</sub>PO<sub>4</sub> on HCOOH is evidently not very different from the effect on the corresponding reaction with H<sub>2</sub>SO<sub>4</sub> at  $25^{\circ}$ , as the values given in the last columns indicate. This is also evident from the slopes of the curves in

Fig. 1, which show further that the effect of water on the rate of reaction becomes less marked as the amount of water is increased. The form of the curve also suggests that the relation is exponential in character. When the logarithm of the velocity constant is plotted against the amount of water added a straight line is obtained (Fig. 1, curve 3). When this logarithmic curve is extrapolated to the ordinate axis to obtain the value for the velocity constant at zero molality of water a value of 2340 for  $k \times 10^3$  is obtained. This value can hardly be considered as a reliable constant for zero molality of water because of equilibrium changes that take place in the complete

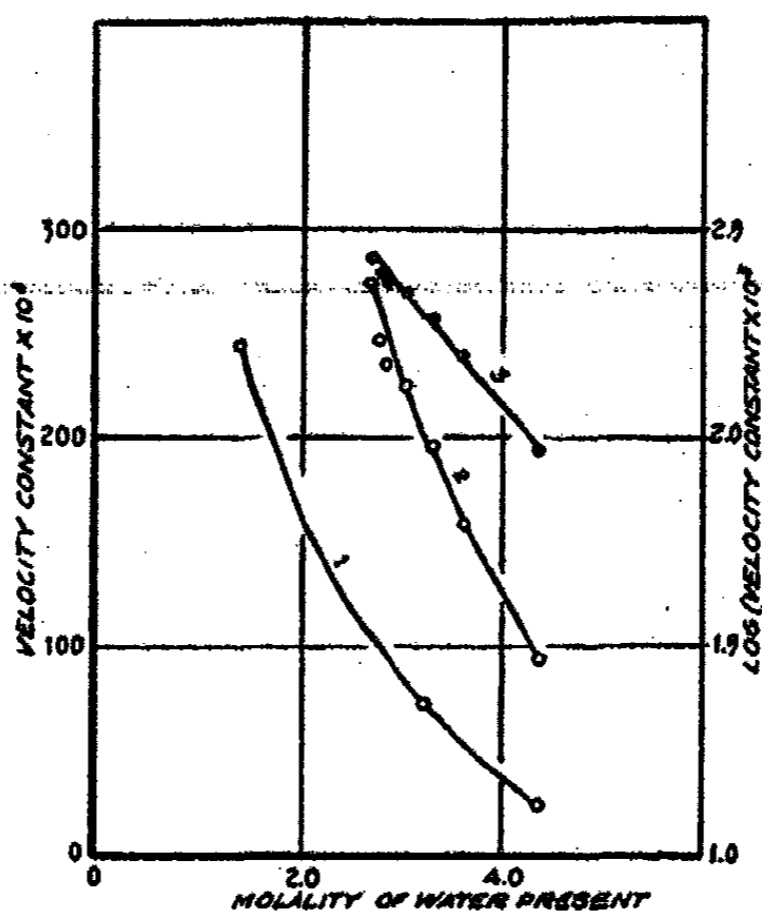

FIG. 1

1. Relation between Amount of Water Present and Rate of Dehydration of Formic Acid by Sulfuric Acid.
2. Same as above for Phosphoric Acid (using Sodium Formate).
3. Logarithmic Representation of (2). (Referred to right hand axis).

dehydration of the phosphoric acid solutions. The value simply represents the maximum velocity constant which would be reached if the rate of reaction increased by the same proportion with decreasing water content, over the range of composition 0 to 4.6% water as it does between 7.34 and 4.6% water.

*Effect of Addition of Various Phosphoric Acids to the Reaction Mixture.* To determine which of the various modifications of phosphoric acid was effective in dehydrating formic acid, the pyro and meta forms from different sources were added to the reaction mixture and the effect on the velocity constant determined. If the dehydrating action of the mixture was due entirely to the action of the pyro and meta forms present, the addition of these forms in the pure state should increase the reaction rate. The results obtained by the addition of various acids to acids A and B are shown in Tables IV and V.

From these tables it is plain that addition of pyro and meta varieties of phosphoric acid has little accelerating effect on the reaction. Metaphosphoric acid seems to have an inhibitory effect on the reaction of HCOOH with acid A. Pyro acid does not affect the rate of reaction with acid A, but slightly accelerates the reaction of the ortho acid solution (acid B). The addition of pyro and meta acids in quantities more than sufficient to bring the percentage of these acids in the solution to the same value as is present in acid A, in no case gives a rate of reaction approaching that of acid A.

TABLE IV  
Effect of Addition of Various Phosphoric Acids to Acid A

Acid added to Acid A	$k \times 10^3$
None (pure acid A)	243
15% meta acid (prepared by heating $(\text{NH}_4)_2\text{HPO}_4$ at temperature of $280^\circ$ )	238
15% meta (same as above) but solution was held in thermostat 1 hour before starting reaction	194
25% meta (same as above) but solution was held in thermostat 1 hour before starting reaction	154
12% pyro acid (prepared by heating $\text{H}_3\text{PO}_4$ at $215^\circ$ )	232
12% pyro (prepared by heating equimolecular quantities of $\text{H}_2\text{PO}_4$ and $\text{HPO}_3$ at $100^\circ$ )	230
$\text{P}_2\text{O}_5$ (varying quantities, 10-25%)	294-413

TABLE V  
Effect of Addition of Various Acids and Salts to Acid B

Substance added to Acid B	$k \times 10^3$
None (pure acid B)	16.1
12% meta acid (commercial C.P. Grade)	17.0
12% meta acid (prepared from $(\text{NH}_4)_2\text{HPO}_4$ )	17.6
12% pyro (prepared by heating $\text{H}_3\text{PO}_4$ at $215^\circ$ )	20.7
12% pyro (prepared by heating equimolecular quantities of $\text{HPO}_3$ and $\text{H}_3\text{PO}_4$ at $100^\circ$ )	18.3
5% pyro (commercial C.P. grade)	15.8
12% " " "	20.2
50% acid A	45.4

The effect of pure pyrophosphoric acid on the rate of reaction of 100% orthophosphoric acid with formic acid was also determined. Pure ortho acid gave a velocity constant of 74. This is less than one third the value obtained for acid A. When pure pyro acid was added to this pure ortho acid in amounts sufficient to make the composition 10% by volume of pyro acid, the value  $k \times 10^3$  was 72, a difference well within the experimental error.

*Effect of Heating Acid B to  $250^\circ$  in a Sealed Bomb.* In order to determine whether the increased action of the concentrated mixture of acids present

in acid A was simply due to a loss of water or to a molecular change in the phosphoric acid, a quantity of acid B (94.6% ortho acid) was heated to 250° in a sealed bomb and held at that temperature for 1/2 hour. The acid was thus given approximately the same heat treatment as had been given to acid A. When this acid was used as a reaction mixture in the reaction with formic acid the value for  $k \times 10^3$  was 20.1, an increase of about 25 percent, but a value still far below that for acid A.

*Effect of Various Salts on Reaction Rate of Acid A.* When 5 g. of  $K_2SO_4$  were added to 100 cc. of phosphoric acid mixture (acid A) the reaction rate was increased from 240 to 328. In order to determine whether this might be due to the formation of sulfuric acid an experiment was carried out in which one cc. of 95%  $H_2SO_4$  was added to 40 cc. of reaction mixture. The reaction rate was increased from 240 to 694. Since even two drops of  $H_2SO_4$  to forty cc. of acid A increased the reaction rate considerably, it seems probable that the sulfuric acid exercises a catalytic influence on the dehydrating action of the phosphoric acid mixture. This small amount would be insufficient to produce the increased reaction rate by dehydration alone.

The effect of the addition of  $Na_2HPO_4$  in varying quantities to acid A is shown in Table VI.

TABLE VI  
Effect of the Addition of  $Na_2HPO_4$  to Acid A

Gms. $Na_2HPO_4$ in 40 cc.	$k \times 10^3$	Gms. $Na_2HPO_4$ in 40 cc.	$k \times 10^3$
0	230	2	93.6
0.5	184	3	85.9
1	125	5.5	28.1

From the above it will be seen that  $Na_2HPO_4$  exerts a distinct inhibitory effect on the reaction. This is true also for the tri-basic potassium phosphate. When one gram of  $K_3PO_4$  was dissolved in 40 cc. of acid mixture and the solution used as a reaction mixture, a value of  $k \times 10^3$  of 149 was obtained. This value is slightly higher than the corresponding one for the same amount of  $Na_2HPO_4$ , indicating that the inhibitory effect of  $Na_2HPO_4$  on the dehydration reaction of acid A with  $HCOOH$  is greater than the effect of  $K_3PO_4$ .

#### Discussion of Results

Before any attempt is made to explain the action of phosphoric acid on formic acid, evidence must first be obtained to show which of the phosphoric acids is responsible for this reaction. Unfortunately such evidence is not available. That ortho phosphoric acid is not the active substance is evidenced by the fact that 100 percent ortho acid is less active than solutions containing smaller concentrations of this acid (see Table II). That the meta and pyro acids are not primarily responsible for the decomposition of the formic acid is evident from the data in Tables IV and V where the addition of these acids to a solution of orthophosphoric acid is seen to be practically without effect on the activity of the orthophosphoric acid alone. There re-



mains the possibility of the existence of other phosphoric acids formed either by the association of molecules of the known acids or by the interaction of these acids with each other or with water. Such acids would undoubtedly break down upon dilution and consequently would not be detected by the ordinary analytical procedures. They would exist in solution in equilibrium with water and the other acids and it is quite possible that in solutions of such high concentration such equilibria would be reached slowly. This would explain the increase in the activity of acid B after heating in a sealed tube, and also the marked effect of the addition of traces of sulfuric acid to the reaction mixture. The existence of other phosphoric acids is mentioned in the literature. Berthelot and André<sup>1</sup> state that forms of phosphoric acid intermediate in composition between the pyro and meta forms are formed in the hydration of the meta acid. These are said to have the formulas  $H_5P_3O_{10}$  and  $H_6P_4O_{13}$ , although no proof of the existence of these acids is given. Holt and Meyers<sup>2</sup> state that the meta and pyro acids also give solutions containing complex molecules.

In comparing the dehydration of formic acid by phosphoric acid with its dehydration by sulfuric acid, certain similarities in the behavior of the two acids lead to the conclusion that the mechanism of dehydration is the same and depends in each case upon intermediate compound formation. The dehydrating action of sulfuric acid upon formic acid is believed to be due to the formation of an unstable oxonium compound which breaks down into water and carbon monoxide. The tendency of sulfuric acid to form such compounds has been demonstrated by James Kendall and his students, who state that the tendency of compound formation of sulfuric acid with other acids depends upon the difference in acidity between the two acids. The decomposition of formic, malic and triphenyl acetic acids by sulfuric acid has been studied by the author of this paper and his students, and the decomposition of oxalic acid has been investigated by Bredig and Lichty.<sup>3</sup> Dr. H. R. Dittmar<sup>4</sup> says "Considering the tendency of compound formation of sulphuric acid with another acid as being dependent upon the difference of acidity, and assuming that this tendency to form a molecular complex is proportional to the velocity of decomposition, then in the case of oxalic, malic, formic and triphenylacetic acids, the weakest acid would most readily form an intermediate compound with sulphuric acid, so the speed of decomposition would be greatest. The order of decreasing acidity of these four acids is: oxalic, malic, formic, and triphenylacetic. The velocity of decomposition increases in the same order from oxalic, to malic, formic, and lastly triphenylacetic which decomposes most rapidly."

The tendency of phosphoric acid to form oxonium compounds has long been known and has recently been demonstrated in the case of several organic acids by Mr. R. S. Kepfer of this laboratory. Phosphoric acid is a much weaker acid than sulfuric acid, consequently its tendency to compound

<sup>1</sup> Berthelot and André: *Compt. rend.*, 123, 773 (1896).

<sup>2</sup> Holt and Meyers: *J. Chem. Soc.*, 99, 384 (1911).

<sup>3</sup> Bredig and Lichty: *Z. Elektrochemie*, 12, 450 (1906).

<sup>4</sup> Dittmar: *J. Phys. Chem.*, 23, 533 (1929).

formation would be less, which is borne out by the fact that its action upon formic and oxalic acids is much weaker than the action of sulfuric acid.

In the study of the action of sulfuric acid upon the acids listed above it was found that many substances, among which water is an outstanding example, acted as negative catalysts towards this reaction. These substances all form molecular addition compounds with sulfuric acid. Similarly, water and certain phosphates, substances which are known to combine with phosphoric acid, have a decided inhibitory action upon the reaction between phosphoric acid and formic acid.

This investigation is being continued from the standpoint of the composition of concentrated solutions of phosphoric acid.

#### Summary

1. Formic acid when heated with concentrated phosphoric acid at a temperature of  $120^{\circ}$  breaks up quantitatively into carbon monoxide and water.
2. The speed of this reaction has been followed by measuring the rate of evolution of gas. The reaction is unimolecular.
3. The temperature coefficient of the reaction is approximately 1.82.
4. The addition of small amounts of water and of certain soluble phosphates inhibits the reaction.
5. The relationship between the amount of water present and the velocity constant has been shown to be exponential.
6. The velocity of the reaction is greatly accelerated by the presence of small amounts of sulfuric acid.
7. The active dehydrating agent is neither the ortho, meta or pyro form of phosphoric acid. It is believed that in the high concentrations of phosphoric acid used in these experiments another form of phosphoric acid is largely responsible for the dehydration of the formic acid.

*Madison, Wis.*

5-176

## THE APPLICATION OF THE QUINHYDRONE ELECTRODE TO SOLUTIONS OF PHENOL AND CRESOLS

BY P. E. ROLLER

The application of the quinhydrone electrode in the place of the hydrogen electrode has been a source of interest, and its application where the pH is less than eight or nine has been widely varied.<sup>1</sup> The quinhydrone electrode is especially applicable to dilute solutions which have a maximum concentration of approximately one-tenth molar.<sup>2</sup> The present investigation was designed to determine its application in the case of the maximum concentration which should be used and where the pH was fairly large. *o*-cresol, *m*-cresol, *p*-cresol, and phenol were used in this work.

### Method and Materials

The apparatus consisted of a potentiometric arrangement. An L. and N. new student type potentiometer was used in conjunction with a sensitive wall galvanometer. The cell consisted of the following:

Quinhydrone (Sat.)

Pt. / .02 molar KCl / Sat. KCl / .1 N KCl, Hg<sub>2</sub>Cl<sub>2</sub> / Hg  
Phenol or cresol

(Quinhydrone half-Cell) (Connecting (.1 N. Calomel half-cell) solution)

The cell was made up of two calomel electrode vessels which were similar in type to those used by Lewis, Brighton, and Sebastian.<sup>3</sup> Potassium chloride solution saturated with calomel was maintained in the supply bulb for the calomel half-cell. The calomel electrodes were prepared from fine calomel and over a period of eight or nine months did not vary more than .0005 volts. The electrode vessel which was used for the quinhydrone electrode had two platinum electrodes (wire two inches in length) which were sealed in glass tubes extending through the stopper of the electrode vessel. The two electrodes were used to serve as a check against each other. The cell was maintained at a temperature of 25°C ± .02° by a water thermostat.

Since the hydrogen ion concentration was fairly small, a small amount of potassium chloride (approximately .02 molar) was added. This enabled a definite reproducible balance on the potentiometer to be obtained. The water which was used for the solutions was distilled for each solution. The phenol or cresols and the potassium chloride were added during the dis-

<sup>1</sup> Billmann: Bull., 41, 213 (1927); Trans. Faraday Soc., 19, 676 (1923); Sørensen, Sørensen, and Linderstrom-Lang: Ann. Chim., 16, 283 (1921); Granger and Nelson: J. Am. Chem. Soc., 43, 1401 (1921).

<sup>2</sup> Billmann and Lund: Ann. Chim. (9) 16, 321 (1921).

<sup>3</sup> Lewis, Brighton and Sebastian: J. Am. Chem. Soc., 39, 2245 (1917).

tillation. The flask was stoppered and cooled in the thermostat. The period of exposure to the air was only long enough to prepare the quinhydrone electrode.

The phenol used was Baker's analyzed. The o-cresol had a melting point of 30 to 31°C., the m-cresol a melting point of 10 to 11°C., and the p-cresol a melting point of 32 to 34°C. The cresols were recrystallized at least ten different times. This insured a more pure product. However the potentials produced before and after crystallization varied only with in experimental error.

The water which was used in the solutions had a purity which permitted a conductivity of 3 to 5  $\times 10^{-6}$  mhos.

The quinhydrone was prepared by the method of Billmann and Lund.<sup>1</sup>

#### Standardization of Phenol and Cresol Solutions

**Cresols:** The cresols were standardized by a method similar to that of Ditz and Cedivoda.<sup>2</sup> Two cubic centimeters of the cresol solution (approximately 0.1 molar) was treated with sufficient 0.1 N. bromide-bromate solution (generally from ten to eighteen cc.) until there was a slight excess of bromine when 3 cc. of HCl (1:1) was present. After one minute 5 cc. of 20 percent KI solution was added. After standing one hour the excess iodine was titrated with standard thiosulfate solution. This procedure permitted the addition of two atoms of bromine to the o-cresol and the p-cresol and three atoms of bromine to the m-cresol.

**Phenol:** The phenol was standardized by a method similar to that of Redman, Weith, and Brock.<sup>3</sup> The process was similar to the one for the cresols except more acid was added so that the solution would be in excess of .48 N. HCl. The procedure permitted the addition of three atoms of bromine to phenol.

#### Experimental Results

For a system of quinhydrone, hydroquinone, quinone, and hydrogen ions, the following approximate equation may be applied.

$$E_h = E_o - \frac{RT}{2F} \ln^n \frac{S_r - Q}{S_o - Q} + \frac{RT}{2F} \ln^n (K_1 K_2 + K_1 H + H^{+2})$$

$E_h$  is the observed potential referred to the normal hydrogen electrode.

$E_o$  is a constant characteristic of the oxidation-reduction system.

$S_r$  and  $S_o$  are the concentrations of the reductant and oxidant.

$Q$  is the concentration of the undissociated quinhydrone which is in solution.

$K_1$  and  $K_2$  are the dissociation constants of the hydroquinone.

If  $K_1$  and  $K_2$  are small and  $S_r - Q$  is approximately equal to  $S_o - Q$ , then the equation becomes

$$E_h = E_o + \frac{RT}{2F} \ln(H^{+2})$$

<sup>1</sup> Billmann and Lund: Ann. Chim., (9) 16, 321 (1921).

<sup>2</sup> Ditz and Cedivoda: Z. angew. Chem., 37, 873 (1899).

<sup>3</sup> Redman Weith, and Brock: J. Ind. and Eng. Chem., 5, 389 (1913).

(The assumption is made that the hydrogen ion concentration and hydrogen ion activity are identical).

The above equation may be written

$$\frac{E_o - E_h}{.000198322T} = \text{pH}$$

$E_o$  at 25°C. was determined by Billmann as +.6690 volts with respect to the hydrogen electrode.

The signs of the potentials of the electrodes are chosen so that they have the signs of the metals as found in the cells made up of the given electrodes and the reference electrodes, either the hydrogen electrode or the N/10 calomel half-cell.

$E_h$  becomes +.3353 volts +  $\pi_Q$  where  $\pi_Q$  is the measured potential with reference to the N/10 calomel half-cell.

Sørensen's value of the N/10 calomel half-cell is used in which no correction is made for the saturated salt bridge since phenol and the cresols have a fairly low hydrogen ion concentration.

Therefore the final equation becomes

$$\frac{.3637 - \pi_Q}{.05910} = \text{pH}$$

The following tables give  $\pi_Q$  for typical solutions of phenol, o-cresol, m-cresol, and p-cresol.

		Phenol .1218 molar	
	Electrode No. 1		Electrode No. 2
Trial I.	+ .0262 volts		+ .0237 volts
	.0260		.0237
	.0260		.0232
Trial II.	+ .0266 volts		+ .0218 volts
	.0257		.0222
	.0257		.0220
Trial III.	+ .0296 volts		+ .0295 volts
	.0298		.0290
	.0298		.0295
Average	+ .0272 volts		+ .0250 volts
Mean value of the two averages			+ .0261 volts

$\text{pH} = 5.713$  or the hydrogen ions concentration =  $.2 \times 10^{-6}$  N. If the assumption can be made that there is the same number of phenol ions as there are hydrogen ions, then the dissociation constant will become  $.33 \times 10^{-10}$ . This value agrees fairly well with the value obtained by Walker and Cormack<sup>1</sup> by conductivity, which was  $1.3 \times 10^{-10}$  at 18°C., the value obtained from

<sup>1</sup> Walker and Cormack: J. Chem. Soc., 77, 5 (1900).

the conductivity of ammonium phenolate by Lunden<sup>1</sup> which was  $1.09 \times 10^{-10}$  at 25°C., and the value obtained by van Laar<sup>2</sup> from the hydrolysis of calcium phenolate which was  $.42 \times 10^{-10}$ , but is considerably less than the smallest value of Bader<sup>3</sup> which was  $56 \times 10^{-10}$  at 25°C.

Electrode No. 1		o-cresol .1016 molar	Electrode No. 2	
Trial I.	+ .0062 volts			+ .0050 volts
	.0057			.0057
	.0062			.0052
Trial II.	+ .0052 volts			+ .0052 volts
	.0054			.0052
	.0054			.0047
Trial III.	+ .0067 volts			+ .0067 volts
	.0082			.0067
Trial IV.	+ .0066 volts			+ .0057 volts
	.0062			.0057
	.0062			.0057
Average	+ .0069 volts			+ .0056 volts
Mean value of the two averages				+ .0062 volts

pH = 6.05 or the hydrogen ion concentration  $.89 \times 10^{-6}$  N. Dissociation constant (K) =  $.78 \times 10^{-11}$ .

Electrode No. 1		m-cresol .1072 molar	Electrode No. 2	
Trial I.	- .0077 volts			- .0082 volts
	.0074			.0082
	.0072			.0072
				.0074
Trial II.	- .0074 volts			- .0077 volts
	.0073			.0077
	.0073			.0073
Trial III.	- .0073 volts			- .0070 volts
	.0073			.0077
	.0060			.0060
	.0065			.0072
Average	- .0071 volts			- .0074 volts
Mean of the two averages				- .0073 volts

pH = 6.28 or the hydrogen ion concentration =  $.53 \times 10^{-6}$  N. Dissociation constant (K) =  $.26 \times 10^{-11}$ .

<sup>1</sup> Lunden: Z. physik. Chem., 70, 249 (1910).

<sup>2</sup> van Laar: Z. physik. Chem., 12, 742 (1893).

Bader: Z. physik. Chem., 6, 289 (1890).

		p-cresol .1112 molar		
	Electrode No. 1		Electrode No. 2	
Trial I.	+ .0366 volts .0365 .0363		+ .0363 volts .0354 .0356	
Trial II.	+ .0332 volts .0328		+ .0320 volts .0320	
Trial III.	+ .0366 volts .0367 .0367		+ .0366 volts .0363 .0353	
Trial IV.	+ .0363 volts .0371 .0376		+ .0367 volts .0366 .0356	
Average	+ .0360 volts		+ .0353 volts	
Mean of the two averages			+ .0356 volts	

pH = 5.55 or the hydrogen ion concentration  $.29 \times 10^{-6}$  N. Dissociation constant (K) =  $.75 \times 10^{-10}$ .

The above data indicates not only the degree of dissociation of phenol and the cresols but also the order of magnitude of the dissociation constants. Although these values can not be taken as absolute values due to certain assumptions which have been made

[The identity of activity and hydrogen ion concentration.

The neglecting of liquid potentials for the saturated potassium chloride bridge.

The neglecting of the dissociation of the hydroquinone]

the variations are within the experimental errors which the method involves. The values for the cresols vary considerably from the data of Bader<sup>1</sup> as would be expected since his value for phenol has not been rechecked by other investigators. The value of the dissociation constant for phenol which Bader got was at least 40 times the value obtained by the other investigators.

	Bader's values for (K)	Value by quinhydrone electrode
phenol	$56 \times 10^{-10}$	$.33 \times 10^{-10}$
o-cresol	$42 \times 10^{-9}$	$.78 \times 10^{-11}$
m-cresol	$17 \times 10^{-9}$	$.26 \times 10^{-11}$
p-cresol	$11 \times 10^{-9}$	$.75 \times 10^{-10}$

As will be observed from the data from the quinhydrone electrode, p-cresol is the stronger acid of the cresols while Bader's values indicate the opposite.

<sup>1</sup> Bader: Z. physik. Chem., 6, 289 (1890).

**Summary**

- (1) The quinhydrone electrode was used in the determination of pH values for approximately .1 molar solutions of phenol and the cresols.
- (2) Constant reproducible potentials were obtained in which two electrodes were used as a check against each other.
- (3) Upon the assumption that there were as many phenol and cresol ions present as hydrogen ions, the dissociation constants were calculated.

*Kent Laboratory, University of Chicago  
and Science Hall, Valparaiso University.*



## THE EFFECT OF SOME ELECTROLYTES ON THE INVERSION OF EMULSIONS

BY H. V. TARTAR, R. E. LOTHROP AND G. F. PETTENGILL

This paper presents a continuation of work previously reported from this laboratory.<sup>1</sup> The object of the investigation was to study the effect of some electrolytes on several sodium and potassium soaps using non-aqueous phases of widely variant composition.

### Preparation of Materials

Sodium and potassium oleates were prepared from purified oleic acid by the method described by Harkins and Zollman.<sup>2</sup> The oleic acid was probably somewhat impure; apparently very pure oleic acid has never been prepared.<sup>3</sup>

The sodium and potassium soaps of stearic,<sup>4</sup> lauric, and pelargonic acids were prepared by methods very similar to the preparation of sodium and potassium oleates. Stearic acid, U. S. P., and lauric and pelargonic acids manufactured by the Eastman Kodak Company were used.

The organic liquids, "oils," used in this investigation were of "C. P. Analyzed" quality and sponsored by a reliable manufacturer. They were distilled before using, the boiling points being used as tests for purity.

The salts and bases used were of "C. P. Analyzed" grade, the bases containing a small amount of carbonate.

### Experimental

*Procedure.* The emulsions were made in glass vials as in the previous work. The same mechanical shaking machine was also employed. In some cases when 15 minutes shaking in the mechanical shaker failed to give complete emulsification, it was followed by shaking by hand. This was found very effective in many cases, because the period of rest between mechanical shaking and hand shaking facilitated the formation of the emulsion. In all cases the ration of the volume of the aqueous phase to that of the "oil" phase was 3 to 1 or 1 to 3 depending on the type of emulsion produced in a preliminary trial.

The emulsions were tested for type by the Briggs drop test<sup>5</sup> and a modification of the conductivity method as proposed by Clayton<sup>6</sup> and experimentally

<sup>1</sup> Tartar, Shea, Duncan and Ferrier: *J. Phys. Chem.*, 33, 435 (1929).

<sup>2</sup> Harkins and Zollman: *J. Am. Chem. Soc.*, 48, 69 (1926).

<sup>3</sup> Lapworth, Pearson and Mottram: *Biochem. J.*, 19, 7 (1925).

<sup>4</sup> When the investigation was about completed it was found that the stearates used were not quite pure. Some of the acid liberated from the soap gave a melting point of 63.5° (pure stearic acid, 69°). The data with the stearates is presented, however, for comparison. In the work by Wellman and Tartar which follows, pure stearates were prepared. They found that potassium stearate emulsions can be inverted by the addition of potassium chloride.

<sup>5</sup> Briggs: *J. Phys. Chem.*, 18, 34 (1914).

<sup>6</sup> Clayton: *Brit. Ass. Colloid Reports*, 2, 114 (1918).

verified by Bhatnagar.<sup>1</sup> Bhatnagar used a cell with platinum electrodes, an ammeter, a constant-voltage supply, and determined the type of emulsion from the amount of electrical current. We have used the usual set-up of apparatus for conductivity determinations, the conventional Wheatstone bridge arrangement.

In the following tables the symbol OW signifies oil-in-water emulsion and WO signifies water-in-oil emulsion. The figures representing the concentration of salt and of base are the concentrations in the final aqueous phase of the emulsion.

*Emulsions stabilized with Sodium Oleate.* The results of these experiments are reported in Table I. The emulsions made with an aqueous solution of

TABLE I  
Effect of Sodium Chloride and of Sodium Hydroxide  
on Emulsions stabilized with Sodium Oleate

(Composition of emulsion: 2 per cent sodium oleate;  
NaCl, 0.5 cc.; NaOH, 0.5 cc.; "oil" 6 cc.)

Normality of Sodium Hydroxide	Normality of Sodium Chloride									
	None	0.15	0.20	0.25	0.30	0.35	0.40	0.45	0.50	
Carbon Tetrachloride										
0.050	OW	OW	OW	broke	WO	WO	WO	WO	WO	WO
0.010	OW	OW	OW	OW	broke	WO	WO	WO	WO	WO
0.002	OW	OW	OW	OW	broke	WO	WO	WO	WO	WO
0.001	OW	OW	OW	OW	broke	WO	WO	WO	WO	WO
0.0002	OW	OW	OW	OW	broke	WO	WO	WO	WO	WO
None	OW	OW	OW	OW	broke	WO	WO	WO	WO	WO
Chloroform										
0.050	OW	OW	OW	OW	OW*	OW*	WO	WO	WO	WO
0.010	OW	OW	OW	OW	OW*	OW*	WO	WO	WO	WO
0.002	OW	OW	OW	OW	OW	OW*	OW*	broke	WO	WO
0.001	OW	OW	OW	OW	OW	OW*	OW*	broke	WO	WO
0.0002	OW	OW	OW	OW	OW	OW*	OW*	broke	WO	WO
None	OW	OW	OW	OW	OW	OW*	OW*	broke	WO	WO
Ether										
0.050	OW	OW	OW	broke	OW	OW	OW	OW	OW	OW

sodium oleate and carbon tetrachloride, were easily inverted by the addition of sodium chloride. The WO emulsions were not very stable. Reversing the phase volume ratio gave the same results.

With chloroform the data marked (\*) were results consisting of a thick layer of OW emulsion at the top, part of the oil being separated. Homogeneous emulsions OW were obtained by reversing the phase-volume ratio.

<sup>1</sup> Bhatnagar: J. Chem. Soc., 117, 542 (1920).

TABLE II  
Effect of Sodium Chloride and Sodium Hydroxide  
on Sodium Stearate Emulsions  
(Composition of emulsion: Sodium chloride 1.5 cc.; sodium hydroxide, 1.5  
cc.; 0.33 percent sodium stearate, 3 cc.; and "oil," 2 cc.)

Normality of Sodium Hydroxide	Normality of Sodium Chloride								
	None	0.15	0.20	0.25	0.30	0.35	0.40	0.45	0.50
Benzene									
0.050	WO	WO	WO	WO	WO	WO	WO	WO	WO
0.010	WO	WO	WO	WO	WO	WO	WO	WO	WO
0.002	OW	WO	WO	WO	WO	WO	WO	WO	WO
0.001	OW	WO	WO	WO	WO	WO	WO	WO	WO
0.0002	OW	broke	WO	WO	broke	WO	WO	WO	WO
None	OW	broke	WO	WO	broke	WO	WO	WO	WO
Xylene									
0.050	WO	WO	WO	WO	WO	WO	WO	WO	WO
0.010	WO	WO	WO	WO	WO	WO	WO	WO	WO
0.002	OW	WO	WO	WO	broke	broke	WO*	WO*	WO
0.001	OW	WO	WO	WO	WO	WO*	WO*	WO*	WO
0.0002	OW	WO	WO	WO	broke	broke	WO	WO	WO
None	OW	WO	WO	WO	broke	broke	WO*	WO*	WO*
Chloroform									
0.050	WO	WO	WO	WO	WO	WO	WO	WO	WO
0.010	WO	WO	WO	WO	WO	WO	WO	WO	WO
0.002	OW	WO	WO	WO	WO	WO	WO	WO	WO
0.001	OW	WO	WO	WO	WO	WO	WO	WO	WO
0.0002	OW	WO	WO	WO	WO	WO	WO	WO	WO
None	OW	WO	WO	WO	WO	WO	WO	WO	WO
Carbon Tetrachloride									
0.050	WO	WO	WO	WO	WO	WO	WO	WO	WO
0.010	WO	WO	WO	WO	WO	WO	WO	WO	WO
0.002	OW	WO	WO	WO	WO	WO	WO	WO	WO
0.001	OW	WO	WO	WO	WO	WO	WO	WO	WO
0.0002	OW	WO	WO	WO	WO	WO	WO	WO	WO
None	OW	WO	WO	WO	WO	WO	WO	WO	WO

\* These broke when emulsified by the machine; they were finally prepared by hand shaking.

The ether emulsions were easily prepared and formed transparent opalescent gels.

*Emulsions with Sodium Stearate.* In this series the volume ratio of the phases was reversed from that used in the preparation of ordinary oil-in-water emulsions, after preliminary tests had shown that nearly all of the emulsions were the WO type. The type was found to be independent of the phase-volume ratio. The data will be found in Table II.

A very interesting effect of temperature on the inversion of emulsions was noted while performing the experiments with chloroform and carbon tetrachloride. On the day the chloroform emulsions were first prepared, the laboratory temperature was approximately  $37^{\circ}$  and the inversion point came between concentrations 0.25 and 0.30 normal sodium chloride. The next day the weather conditions had changed markedly to a temperature of about  $21^{\circ}$  and the results presented herein were obtained. When the carbon tetrachloride emulsion containing 0.002 normal sodium hydroxide and 0.15 normal sodium chloride, was prepared at  $50^{\circ}$  an oil-in-water emulsion was easily formed which broke when cooled with ice water. Upon warming the separated phases to  $15^{\circ}$  and shaking, a water-in-oil emulsion was produced.

The xylene emulsions were prepared on different days under different temperature conditions which probably accounts for the "broke" emulsions.

Ethyl ether gave oil-in-water emulsions only.

*Emulsions with Sodium Laurate.* Only oil-in-water emulsions could be obtained with sodium laurate, using the same concentrations of base and salt as were used with sodium stearate and sodium oleate. A 2 percent solution of sodium laurate was first tried but the soap salted out in a solid cake; a 0.33 percent solution was chosen for use. All of the emulsions when first formed had a good, creamy appearance, but they were unstable; most of those with benzene and xylene separated in about an hour; those with chloroform and carbon tetrachloride, in a day or two. The emulsions having the highest concentration of sodium hydroxide with no sodium chloride, were the most stable.

*Emulsions with Potassium Oleate.* The emulsions prepared with potassium oleate and using benzene, xylene, chloroform, carbon tetrachloride and ethyl ether as "oils," were the oil-in-water type. The composition of each emulsion was: 2 percent potassium oleate, 1 cc.; potassium chloride, 0.5 cc.; potassium hydroxide, 1.0 cc.; and "oil," 6 cc. The concentrations of potassium hydroxide were the same as for sodium hydroxide in the sodium stearate emulsions. The potassium chloride concentration was varied from 0.2 to 0.9 normal, in steps of 0.1 normal.

Some of the emulsions were difficult to prepare, especially those with the higher salt concentrations. All were quite stable when formed.

No inversion was obtained when a 10 percent potassium oleate solution was used with benzene and xylene.

*Emulsions with Potassium Stearate.* The composition of these emulsions was exactly analogous to those prepared with potassium oleate. Benzene, toluene and ether gave permanent, creamy emulsions which formed quite readily; chloroform and carbon tetrachloride emulsified with difficulty but the emulsions were stable. All were the oil-in-water type.

*Emulsions with Potassium Laurate.* These were all of the OW type. The composition of the members of the series was the same as the potassium oleate emulsions, except for the change in soap. Benzene and toluene emulsified with extreme ease and did not show signs of "breaking" until after 2

weeks. The emulsions with chloroform and carbon tetrachloride formed easily but were much less stable, the former "breaking" in 24 hours and the latter, in 5 hours.

*Potassium Pelargonate as an Emulsifying Agent.* All attempts to prepare good emulsions using potassium pelargonate as the emulsifying agent, failed.

TABLE III

## Comparison of Methods for determining Emulsion Type

(Composition of Emulsions: 0.33 percent sodium stearate, 3 cc.; sodium chloride, 1.5 cc.; sodium hydroxide, 1.5 cc.; benzene, 2 cc.)

Normality of Sodium Hydroxide	Normality of Sodium Chloride					
	None	0.15	0.20	0.30	0.40	0.45
0.05	WO 110000	WO 40000	WO 110000	WO 110000	WO 110000	WO 110000
0.01	WO 110000	WO 110000	WO 110000	WO 110000	WO 110000	WO 110000
0.002	OW 970	WO 6900	WO 110000	WO 110000	WO 110000	WO 110000
0.001	OW 850	WO 2400	WO 110000	WO 110000	WO 110000	WO 110000
0.0002	OW 870	broke	WO 110000	WO 110000	WO 110000	WO 110000
None	OW 900	broke	WO 110000	WO 110000	WO 110000	WO 110000

They all broke within a few minutes except those prepared from ether which did not break for an hour. The ether emulsions were almost transparent and of a collodion-like consistency.

*Comparison of the Briggs' Drop Method and the Conductivity Method for Emulsion Type.* A study of these two methods was made to compare their reliability. The area of each of the electrodes was 1 sq. cm. and they were placed 1/2 cm. apart. The electrodes were supported so that they could be let down easily into the small vials containing the emulsions. The results from the two methods showed excellent agreement.

A typical series of data is reported in Table III. The drop test findings are given as OW and WO; the conductivity, in terms of resistance in ohms.

## Conclusions and Summary

1. Sodium chloride inverted emulsions of water with benzene, xylene, chloroform, or carbon tetrachloride when the less soluble sodium soaps, the

oleate and stearate, were used as emulsifying agents. No inversion was obtained with the more soluble soap, sodium laurate.

2. Attempts to invert emulsions prepared with potassium stearate, oleate, laurate and pelargonate (which are more soluble than the corresponding sodium compounds) by the addition of potassium chloride, were unsuccessful; only oil-in-water emulsions were obtained.

3. Benzene, chloroform and carbon tetrachloride did not emulsify with the same ease nor give emulsions of the same stability, showing that the nature of the "oil" phase is an influential factor.

4. Ethyl ether gave oil-in-water emulsions only with the soaps and electrolytes used.

5. Emulsions prepared with sodium and potassium laurate were not so stable as those made with the oleates and stearates of these metals.

6. The inversion point of soap emulsions is influenced by changes of temperature; rise in temperature favoring oil-in-water type while lowering the temperature favors the water-in-oil type.

7. The conductivity method for determining emulsion type gave results closely concordant with the Briggs' drop method.

*Department of Chemistry,  
University of Washington,  
Seattle, Washington,  
June 24, 1926.*

## A STUDY OF FACTORS CONTROLLING TYPE OF WATER-SOAP-OIL EMULSIONS

BY V. E. WELLMAN AND H. V. TARTAR

### Introduction

The complexity of emulsions is revealed by the many factors which influence their type and stability. The literature<sup>1</sup> on emulsions stabilized with soaps leads almost to confusion because of the variety of factors reported to influence stability and to determine type. There is almost complete agreement, however, on the following: (1) alkali soaps stabilize only oil-in-water emulsions, (2) polyvalent soaps stabilize only water-in-oil emulsions, (3) emulsification is aided by low interfacial tension between the phases and (4) the charge carried by the droplets influences emulsion stability. The purpose of the present investigation was to examine some of these fundamental concepts; the results indicate that the tendency has been to generalize too freely, and that emulsion characteristics cannot be predicted until the exceedingly difficult problem of interrelating the various influential factors has been solved.

### Preparation of Materials

The value of much of the literature dealing with emulsions stabilized by soaps, has been vitiated through the use of materials of questionable purity, and the uncertainty resulting from the use of mixtures such as olive oil, etc. The elimination of these uncertainties will permit a more accurate interpretation of the phenomena observed. Consequently, all materials used in the quantitative part of this work were carefully purified.

#### *Purification of Benzene.*

Benzene of "C.P. Analyzed" quality, b. p. 80° was allowed to stand in contact with concentrated sulfuric acid, with occasional shaking, until the absence of thiophene was shown by the test with isatin and sulfuric acid. The benzene was then washed free from acid with distilled water and dried over calcium chloride. When distilled, the fraction passing over between the corrected temperatures 79.96° to 80.06° was taken. The benzene was used only once.

#### *Preparation of Soaps.*

*Sodium Oleate.* Merck's U. S. P. oleic acid, having an iodine number of 89.9 was purified by the method used by Harkins and Zollman.<sup>2</sup> To an

<sup>1</sup> References to literature must necessarily be made in the body of the report in order that they appear relevant; the subject is too broad to be clearly and conveniently treated as a unit.

<sup>2</sup> Harkins and Zollman: *J. Am. Chem. Soc.*, 48, 69 (1926). It later became known that Lapworth, Pearson and Mottram: *Biochem. J.*, 19, (1925), have shown that this method does not insure the purity of the oleic acid obtained if palmitic acid is present.

alcoholic (95 percent ethyl alcohol) solution of the oleic acid was slowly added, with stirring, a filtered solution of alcoholic sodium hydroxide until a slight excess of the alkali was present. Complete neutralization was accomplished by refluxing the mixture for thirty minutes, after which the hot solution was filtered and the soap allowed to crystallize. The sodium oleate was washed three times with 95 percent ethyl alcohol, and dried between quantitative filter papers. It was then taken up in another portion of alcohol, refluxed for thirty minutes, filtered and allowed to crystallize as before. After drying with filter paper, the soap was allowed to stand over night in contact with cold absolute alcohol. The alcohol was removed by decantation after which the soap was washed with three small portions of absolute alcohol. Final drying was accomplished by warm air (40°) under reduced pressure. The soap thus obtained was almost white, having only a slight cream tint.

*Sodium Stearate.* Eastman Kodak Company's stearic acid, m.p. 68.9°, was dissolved in hot alcohol and a slight excess of a filtered solution of C.P. sodium carbonate was slowly added, with stirring. The solution was refluxed for thirty minutes after which it was filtered hot. The gel which formed on cooling was crushed between filter papers until most of the alcohol and soluble impurities had been removed. The soap was again brought into solution in 95 percent ethyl alcohol and filtered, after which the alcohol was evaporated until the soap set to a gel. It was then crushed in a mortar and brought to dryness on a water bath. After being pulverized, the dried soap was washed three times with absolute alcohol and three times with anhydrous ether. The final drying was done in an oven at 90°.

*Sodium Palmitate and Potassium Stearate.* These soaps were prepared in a manner similar to that used for sodium stearate. The potassium soap, however, did not show such a pronounced tendency to gel.

*Calcium Oleate.* To a known weight of oleic acid an excess of calcium acetate solution was slowly added with stirring. The precipitated calcium soap was thoroughly washed with water, alcohol and ether. Then it was powdered and rewashed, as before, to remove all traces of the acetate.<sup>1</sup>

*Magnesium Oleate and Palmitate, and Barium Oleate.* The above method was not found efficacious for the production of these soaps. They were prepared by metathesis of the acetates with the corresponding sodium soaps. Their final washing was carried out as outlined for calcium oleate.

*Bivalent Soaps of Some Lower Fatty Acids.* Small quantities of magnesium heptylate, magnesium caprylate, magnesium caproate and calcium valerate were made by treating the acids in a small volume of alcohol, with an excess of the carbonates. After removal of the excess carbonates by filtration, the precipitated bivalent soaps were washed with absolute alcohol and then with anhydrous ether.

<sup>1</sup> It was found that just one drop of dilute acid was sufficient to make the calcium easily wetted by water; otherwise it is so little wetted by water that it is difficult to wash.



*Miscellaneous Materials.*

*Water.* All water used in these experiments was distilled water and had an average conductivity of  $5 \times 10^{-6}$  mhos.

*Shaker.* The mechanical shaker employed was that used by Tartar, Duncan, Shea and Ferrier,<sup>1</sup> and consisted of a hot-air engine to the side arm of which a box vial-holder was fastened. The machine gave approximately 300 shakes per minute, having "a vertical amplitude of two inches and a horizontal amplitude at one end only of the vial-holder of two inches."

*Vials.* The emulsions herein reported were prepared in 25 cc. vials which were always carefully washed, soaked in sulfuric acid-dichromate cleaning solution, rinsed and dried. They were stoppered with carefully cleaned, selected corks.

**Transfer of Soap from Aqueous to "Oil" Phase**

On repeating some experiments performed in this Laboratory in the summer of 1928 by Lothrop<sup>2</sup> and Pettengil<sup>3</sup> in which sodium stearate of 0.33 percent (approximately 0.01 normal) concentration was used, it was found that this solution gave water-in-oil emulsions (Briggs drop-dilution method)<sup>4</sup> within widely different phase-volume relationships when shaken with various organic liquids at room temperature. Lower concentrations, 0.002 and 0.003 normal, likewise produced water-in-oil emulsions when 1 cc of 0.2 normal sodium chloride was present. From the similarity of behavior of concentrated sodium stearate solutions and dilute solutions to which small amounts of the salt were added, it was apparent that the salt had a concentrating effect on certain constituents of the soap solution, probably the colloidal constituents. Stated differently, if the proper amounts of soap or salt are added to soap solutions of equal concentrations, a concentrating effect on the colloidal material is noticed in each. These experiments also revealed a very interesting and important property of concentrated solutions of the higher saturated sodium soaps when they were placed in contact with certain organic liquids, such as benzene, toluene, chlorobenzene, gasoline and carbon tetrachloride. When the aqueous phase had a sufficiently high initial concentration of these sodium soaps, there occurred a transfer of soap across the interface, into the organic liquid, in amounts depending on the original concentration and the organic liquid used. These aqueous soap solutions remain macroscopically clear only at temperatures above 45°-50° when not in contact with the non-aqueous phase and set to opaque fibrous gels when cooled to room temperature. This transfer phenomenon has been observed with thirteen liquids, immiscible with water; there are, no doubt, many more which will display similar behavior. The writers believe that *this important property of certain soaps has been entirely overlooked in the study of emulsions.*

The transferred soap appeared to be practically all in the form of the gel; only a trace was found on the evaporation of the benzene in contact with the

<sup>1</sup> Tartar, Duncan, Shea and Ferrier: *J. Phys. Chem.*, 33, 435 (1929).

<sup>2</sup>, <sup>3</sup> Master's theses yet unpublished.

<sup>4</sup> Briggs: *J. Phys. Chem.*, 18, 34 (1914).

gel. The importance of the presence of the soap gel in the non-aqueous phase in systems which yielded only water-in-oil emulsions, was apparently increased by observations made later. When the gel was removed and the two phases shaken together, no emulsification took place. Large amounts of colloidal soap appeared in the non-aqueous phases of unshaken systems at equilibrium when sufficient sodium chloride had been added to salt-out the soap, e.g., sodium oleate; or when sufficient bivalent salt had been added to react with all the water-soluble soap present. Concentrated potassium stearate solutions (0.1 and 0.5 normal) in the presence of potassium chloride transferred an opaque, flaky material to the benzene phase. These systems, as did all others in which solid or colloidal material was shown to be present in the non-aqueous phase, yielded water-in-oil emulsions. These observations support the statement of Mead and McCoy<sup>1</sup> that for the production of a stable emulsion, there must be a "suitable emulsifying agent dissolved or dispersed in the continuous medium." At 25° only water-in-oil emulsions resulted when aqueous sodium stearate solutions whose concentrations exceeded 0.006 normal were shaken with benzene. This limiting concentration will probably vary for different organic liquids; transfer gelation has been observed to slight extent when solutions as low as 0.003 normal were left in contact with benzene for several hours.

The presence of sodium chloride (0.25 normal) in dilute sodium stearate solutions (0.002 normal) also induced the transfer of soap across the interfacial boundary, to form a "benzenated gel." The addition of the electrolyte was immediately followed by a profound change in the character of the interface of the unshaken systems. The height of the interfacial meniscus was greatly reduced and the boundary itself took on, at first, the appearance of a sheet of wrinkled tinfoil. Later tests showed this highly refracting film to be a benzenated gel. Qualitative tests proved that sodium hydroxide (1-normal) in the aqueous phase induced a rapid transfer of soap from a 0.002 normal sodium stearate solution to benzene. The presence of the sodium hydroxide of such strength eliminated the possibility of a transfer of free fatty acid or of acid soaps from the aqueous phase. Water-in-oil emulsions were produced when these systems were shaken.

Although no experimental proof of its existence is presented a micelle of different molecular orientation may be present. McBain<sup>2</sup> indicates that soap micelles which are "colloidally" soluble in water have the hydrocarbon ends of the soap molecules toward the interior of the aggregate. Under the conditions reported here might a rearrangement occur under the specific influence of the organic liquid making them soluble or solvatable in the non-aqueous phase? The benzene-soap gels are quite transparent, having an index of refraction not much different from that of benzene.

Quantitative determinations were made of the amount of soap transferred from aqueous solutions of various concentrations. Sodium stearate

<sup>1</sup> Mead and McCoy; "Colloid Symposium Monograph," 4, 44 (1926).

<sup>2</sup> McBain: "The Study of Soap Solutions" in Bogus: "Colloidal Behavior," 410 (1924).

and sodium palmitate solutions made by dissolving the pure soaps in warm water were placed in contact with equal volumes of benzene, until the lower aqueous layers seemed practically clear (usually allowed to stand 12-16 hours). The aqueous layers were then removed by pipet, whereupon the benzene-soap gel and excess benzene were quantitatively transferred to crucibles. After the benzene had been evaporated on the hot plate, the soaps were ignited to the alkali carbonate and weighed. The results given in Table I for sodium stearate and benzene at 25° are the mean of duplicate determinations, using in each case 25 cc. of the soap solution. Results for sodium palmitate are for a single determination.

TABLE I  
Transfer of Sodium Stearate and Sodium Palmitate from  
Water to Benzene at 25°

Soap	Initial Conc. (N)	Total Soap (g.)	Transferred Soap (g.)	Diff. (g.)	Per cent Transfer
NaSt	0.005	0.0383	0.0211	0.0172	55.3
	0.010	0.0765	0.0611	0.0154	80.3
	0.020	0.1530	0.1384	0.0146	90.5
	0.030	0.2295	0.2115	0.0180	92.2
NaPa	0.005	0.0348	0.0153	0.0195	44.0
	0.010	0.0696	0.0563	0.0131	81.3
	0.020	0.1391	0.1247	0.0144	89.7
	0.030	0.2087	0.2055*	0.0032	98.2*

\*Some aqueous phase enmeshed in gel probably explains high values.

These data show that the amount of soap remaining in the aqueous phase is constant, within experimental error, and perhaps roughly corresponds to the solubility of the sodium soaps in water saturated with benzene. The slight opacity of the aqueous layers, indicated, however, that part of the remaining soap was in colloidal suspension, possibly as acid soap<sup>1</sup> due to some hydrolysis of the resulting dilute soap solutions. The transfer isotherms are given in Fig. 1.

Although no extensive study of extraction of soaps from water by organic liquids was undertaken, some of the values reported above were checked by a method wherein precautions were taken to avoid the presence of carbon dioxide and slight temperature variations, and which permitted a rough estimate of the amount of free fatty acid in the benzene phase. Sodium stearate solutions, 0.01 and 0.02 normal, were placed in contact with benzene in sealed Pyrex flasks. These systems were gently rocked in a thermostat at 25° for 48 hours. The necks of the flasks were then cut off and the phases separated as before. After the benzene had been completely evaporated from the gels, the gels were dissolved in 50 cc. portions of neutralized ethyl

<sup>1</sup> McBain and Taylor: *Z. physik Chem.*, 76, 179 (1911); McBain and Stewart: *J. Chem. Soc.*, 1927, 1392.

alcohol (95 per cent) and the free fatty acid was titrated with sodium hydroxide, 0.0205 normal. The alcoholic solutions were then transferred to crucibles and evaporated to dryness. After correcting for the sodium content introduced by titration the amount of sodium stearate present in the gels could be calculated from the ignited carbonate residues. The results are given in Table II.

The data show that there was some error in this method of analysis because the sum of the sodium stearate in the benzene and of the sodium

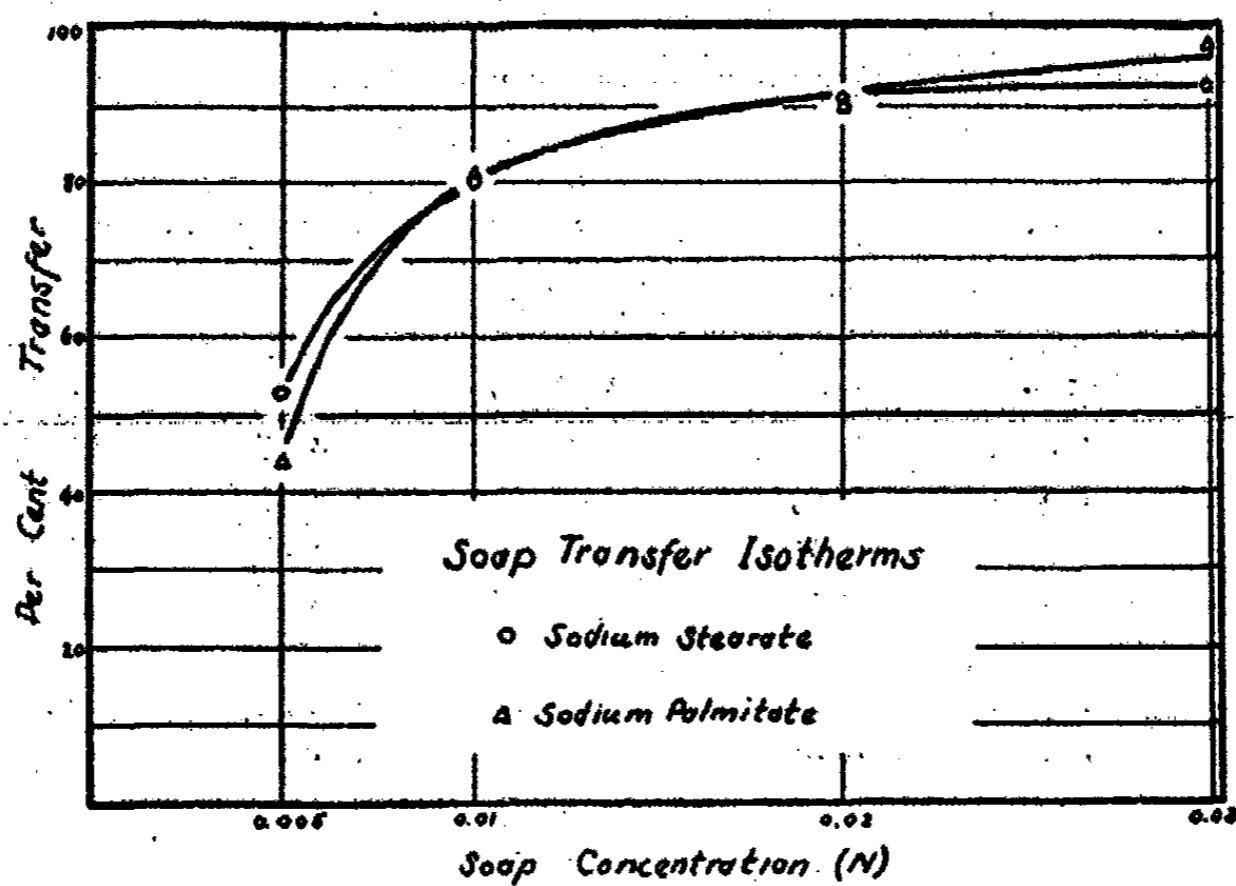

FIG. 1

TABLE II

Transfer of Sodium Stearate and Stearic Acid from Water to Benzene at 25°

Initial Conc. (N)	Total NaSt (g.)	HSt in Benzene	NaSt equiv. of HSt (g.)	NaSt in Bz (g.)	Per cent NaSt Transferred
0.01	0.0765	0.0127	0.0137	0.0654	85
0.02	0.1530	0.0118	0.0127	0.1442	94

stearate equivalent of the stearic acid present is greater than the amount of the sodium stearate initially present in the aqueous phase by about 3 per cent. The per cent sodium stearate transferred is correspondingly greater than that reported in Table I but the agreement is sufficiently close to establish the great preponderance of soap over the fatty acid in the benzenated gels.

Some information concerning the behavior of aqueous soap solutions in contact with benzene and p-xylene containing some of the corresponding fatty acid has been reported recently by McBain and his collaborators. McBain and Buckingham<sup>1</sup> state that at 90° there was a considerable quantity of palmitic acid extracted by p-xylene after the latter was rocked with solu-

<sup>1</sup> McBain and Buckingham: J. Chem. Soc., 1927, 2687.

tions of sodium palmitate. The addition of electrolytes was reported to lower the extractability of the acid from the soap solutions by the p-xylene. This was attributed to the reduction of the amount of molecular soap in solution, driving more of it into the colloidal state, which acts only as a reserve for molecular soap. The work reported here indicated, however, that at 25° electrolytes facilitated the transfer of soap itself to the non-aqueous phase.

The method of analysis of the p-xylene layer as outlined by McBain and Buckingham may be in serious error; the organic liquid was evaporated and the residue apparently considered as palmitic acid only. This may be true with p-xylene at 90° but it certainly is not true with benzene at 25°. In fact McBain and Buckingham<sup>1</sup> found that when the p-xylene contained palmitic acid in high concentrations that the residue weighed more than the total palmitic acid content, indicating that some sodium palmitate had also been extracted. This statement alone throws sufficient doubt on the assumption that the residues in the other cases were totally fatty acids.

McBain and Eaton<sup>1</sup> found that at 25° "sodium laurate is distinctly more extractable than potassium laurate." The work in this laboratory showed that sodium stearate was transferred easily to benzene, whereas potassium stearate fails to exhibit the property of transferred gelation even at 0.50 normal concentration.

Previous investigators of alkali soap emulsion systems have taken no account of the distribution of the soap between the two phases.<sup>2</sup> There are, however, a few scattered reports dealing with phenomena which bear directly on the above observations. No reference to a colloidal transfer of soap under similar conditions has been found in the literature but the existence of alkali soap gels in non-aqueous liquids has been previously observed.

The influence of a second liquid upon the formation of alkali soap gels in such liquids as turpentine, paraffin oil and benzene has been noted by Holmes and Maxson.<sup>3</sup> Since the present work was started Weicherz<sup>4</sup> reported that small quantities of phenol, the alcohols and water promote the solubility of alkali soaps in hydrocarbons and that at high soap concentrations water-in-oil emulsions are formed, reversing to oil-in-water on lowering the concentration. A somewhat similar concentration effect was reported by Harkins and Beeman.<sup>5</sup> They found that "a water-in-oil emulsion was produced by dissolving a large amount of soap in the oil and beating this up with water. This inverted to the ordinary oil-in-water type on the addition of more water." This change was no doubt induced by at least partial transfer of soap to the aqueous phase, or to the displacement of the equilibrium between the opposing emulsification tendencies, that stabilizing the oil-in-water type finally being

<sup>1</sup> McBain and Eaton: *J. Chem. Soc.*, 1928.

<sup>2</sup> Bancroft: *J. Phys. Chem.*, 16, 746 (1912), suggested that the reason Robertson: *Kolloid-Z.*, 7, 7 (1910) obtained both types of emulsions with olive oil and sodium oleate, and only one type when benzene or kerosene replaced olive oil, was the solubility of the soap in high olive oil concentrations and its insolubility in benzene and kerosene.

<sup>3</sup> Holmes and Maxson; "Colloid Symposium Monograph," 5, 287 (1927).

<sup>4</sup> Weicherz: *Naturwissenschaften*, 16, 654 (1928).

<sup>5</sup> Harkins and Beeman: *Proc. Nat. Acad. Sci.*, 11, 631 (1925).

in the ascendance. Fischer and Hooker<sup>1</sup> state that sodium stearate stabilizes water-in-oil emulsions but do not say, however, that the type depends in any way upon the concentration.

Mead and McCoy<sup>2</sup> made the observation that if an oil-in-water emulsion stabilized with sodium oleate were broken by sodium chloride and allowed to stand, some of the soap dissolved in the oil. If then the whole system were restirred vigorously, a water-in-oil emulsion resulted. This emulsion could be reversed by the addition of water and agitation. The latter behavior was undoubtedly due to the solution of more sodium oleate by water, since the salting-out effect of the sodium chloride was reduced by dilution. The parallelism between soap solutions of high concentrations and more dilute solutions to which electrolytes have been added is mentioned by McBain<sup>3</sup> in connection with viscosity of soap solutions. High viscosities may be obtained in either case but "are more quickly obtained by adding further quantities of the soap itself, rather than by adding equivalent amounts of the salts of alkali."

These isolated cases just mentioned confirm the results which have been obtained during the present investigation and indicate that the distribution of the soap between the two phases, regardless of the metal involved, is one type-determining factor which has hitherto been entirely overlooked in theorizing about emulsion type. The writers do not hold that the presence of a soap gel, per se, in the non-aqueous phase is a necessary condition for the production of water-in-oil emulsions at high soap concentrations. It is highly probable, however, that there is a redistribution of emulsifier during emulsification.

#### Influence of Temperature and Concentration of Soap Upon the Inversion of Emulsions

The experiments on the distribution of soap between the two phases suggested that the transfer from one phase to the other might be governed by the solubility of the soaps or their tendency to form solvates. Conditions which might be expected to influence these factors are, temperature, ratio of the volumes of the two phases within certain limits, the presence of electrolytes the specific nature of the organic liquid used and the state of aggregation of the soap in the aqueous phase. Qualitative experiments showed that the water-in-oil emulsions (aqueous phase-sodium-stearate-benzene) were very sensitive to increasing temperature and could be inverted to the oil-in-water type by heating the emulsion tube,<sup>4</sup> followed by gentle shaking. These oil-in-water emulsions could be changed back to water-in-oil systems if allowed to cool and stand for about 30 minutes. The observation was also made that the benzenated soap gel could be made to transfer back to the aqueous phase at approximately the temperature at which the inversion of the emulsions

<sup>1</sup> Fischer and Hooker: "Soaps and Proteins," 156 (1921).

<sup>2</sup> Mead and McCoy: "Colloid Symposium Monograph," 4, 44 (1926).

<sup>3</sup> McBain: Report Brit. Ass. Adv. Sci., 1920, 1-154 A.

<sup>4</sup> Reynolds: J. Chem. Soc., 119, 460 (1921).

took place. Water-in-oil emulsions produced by shaking benzene with dilute stearate solutions containing sodium chloride (0.2 normal) could likewise be inverted to oil-in-water emulsions by warming and shaking.

Perhaps a parenthetical description of these water-in-oil systems should be given. They were entirely similar to water-in-oil emulsions formed when bivalent soaps were used as stabilizers, excepting those stabilized by magnesium oleate. The water droplets were macroscopically visible and usually appeared as clear refractive spheres, probably surrounded by a transparent, plastic film, which prevented their coalescence. The large size of the droplets did not predetermine great instability, as is believed to be the case with oil-in-water emulsions. Some specimens have been standing for four months. Emulsions of the water-in-oil type with sodium stearate and sodium palmitate, especially in the presence of small amounts of sodium chloride, were very stable dispersions and fulfilled every requirement of ordinary emulsions except droplet size. The more concentrated the original soap solution the smaller the water droplets became. These facts argue that the emulsifying film was thicker or that the emulsifying agent functioned in larger aggregates in the water-in-oil than in the oil-in-water emulsions and consequently a given amount of soap occupied a smaller amount of interfacial surface in the stable water-in-oil types.

The appearance of the emulsions near the temperature of inversion changed markedly. Shaking produced a dual emulsion system, composed of large water droplets in which were suspended oil globules. The larger droplets were then white, due to the internal oil-in-water emulsions. Clowes<sup>1</sup> made a somewhat similar observation when inverting sodium oleate oil-in-water emulsions by the addition of calcium chloride. He states: "Beyond the critical point the emulsion consists principally of large drops of water surrounded by oil, which are characterized by the fact that they still contain numerous oil globules — —."

If solubility of the soap as controlled by temperature is an important factor in emulsion formation, emulsions with different soap concentrations should invert at different temperatures; i.e., the equilibrium existing between the two types of emulsifying units, if such there be, or at least between the two opposing functions of the soap present, should be displaced one way or the other through temperature changes.

Soap solutions of the various strengths examined were prepared by adding weighed amounts of pure soap to known volumes of hot water. Dilution of more concentrated solutions or progressive dilution through a series of concentrations was not sufficiently accurate. The method used is subject to small errors due to evaporation, slight volume differences, etc. The experiments were made in triplicate and the emulsions prepared by adding 5 cc of benzene to vials containing 5 cc of the hot soap solutions. The vials were quickly stoppered and allowed to cool to room temperature. They were then placed for 15 to 20 minutes in a thermostat at 5°. The cooled systems were

<sup>1</sup> Clowes: J. Phys. Chem., 20, 407 (1916).

then given 5 minutes of vigorous shaking, meanwhile protecting against excessive radiation effects by having the box of the shaking machine well lined with cloths. Of course some radiation took place. After being examined as to type (Briggs' drop-dilution method) the emulsions were replaced in the thermostat at  $7.5^\circ$  for 15 to 20 minutes and again shaken and examined as before. The temperatures of inversion may be a degree or so too high because they represent the temperature of the thermostat. Examinations of type were made every 2.5 degrees until emulsions of all soap concentrations were

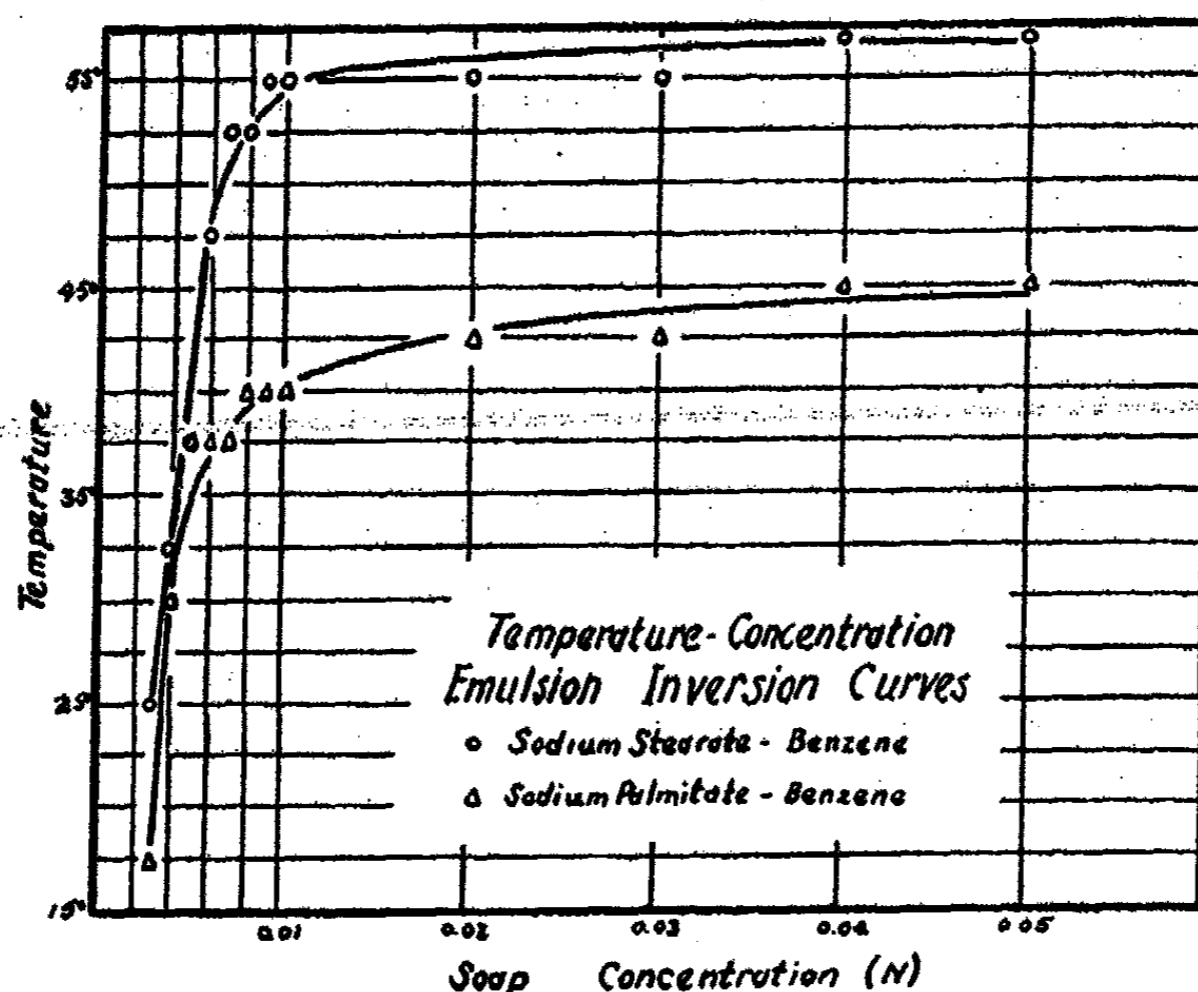

FIG. 2

inverted. The data are given in Table III and are shown graphically in Fig. 2.

The record of similar experiments with benzene-aqueous sodium palmitate systems is given in Table IV and graphed in Fig. 2.

The curves in Fig. 2 permit some very interesting conclusions. To the left and above the temperature-concentration curves the corresponding soap was unable to stabilize water-in-oil emulsions, whereas the area indicated under the curves produced only that type. The greater solubility of sodium palmitate over stearate in water is reflected in its lower "limiting temperature of inversion" at which the curves become approximately horizontal. These limiting temperatures are within a few degrees of the temperatures at which the soap solutions themselves lose their macroscopic colloidal appearance and apparently become clear solutions. The sharpness of this change is quite noticeable for most of the suspended soap disappears at once. In the region of the sharp breaks in the curves the points are a little uncertain. Both types, and especially the dual type, were present. Close to the inversion temperature a few hard shakes by hand proved more effective than machine shaking.





Soap solution-benzene systems which were in equilibrium but had not been shaken sufficiently to produce emulsions, exhibited a return of the soap gel from the benzene to the aqueous phase, when the temperature was slowly increased. Almost complete transfer of the soap from the benzene to water took place 2 to 5 degrees higher than the inversion of the emulsion of corresponding soap concentration. This difference was probably due to the small interfacial areas in the unshaken systems as compared to the same systems after emulsification, making the transfer necessarily slower. Had it been possible to extend the interface without emulsifying the phases the return of the soap to the water probably would have been at the temperature of inversion to the oil-in-water type. At 60° the unshaken sodium stearate gels in benzene completely disappeared and the aqueous layer became very cloudy with colloidal material, leaving only a small amount of flaky substance floating near the benzene side of the interface.

The influence of subsequent lower temperatures on emulsions which had once undergone the water-in-oil to oil-in-water inversion was ascertained by placing the oil-in-water emulsions in a thermostat at 10° for 30 minutes and shaking them vigorously in the machine for 5 minutes. Without exception, water-in-oil emulsions were produced.

Tartar, Duncan, Shea and Ferrier<sup>1</sup> found that organic liquids, immiscible with water, differed in their susceptibility to emulsification by the same soap solution. This difference may be due to the respective transfer-distribution of the soap in the two phases. Although benzene, p-xylene, toluene, nitrobenzene, cyclohexane, chlorobenzene, bromobenzene, cumene, aniline, carbon tetrachloride, chloroform kerosene, gasoline and liquid petrolatum yielded water-in-oil emulsions when the amount of sodium palmitate was sufficient, their specific gelling powers towards the soap were widely different. There are also other properties of the organic liquids which undoubtedly have some effect, either on type directly or upon the stability of emulsions produced. Seifriz<sup>2</sup> reported that he obtained difference in type when light and heavy paraffin oils were shaken with water, wherein casein was used to stabilize the disperse systems; the lighter ones gave oil-in-water, the heavier ones, water-in-oil emulsions. There is a considerable change in the densities of the oils but the viscosities are also becoming greater as the density increases. The viscosity factor seems more apt to control the type of emulsion produced; the more viscous a liquid the greater difficulty to break it into droplets, and the slower the motion of a drop of a second liquid through the viscous one. So in the case of the heavier oils the water was more easily broken into droplets and these droplets were hindered in coalescing by the viscosity of the oil and the protective action of the casein. Stamm and Kraemer,<sup>3</sup> in a paper which gives an excellent criticism of the highly improbable "wedge theory" of emulsions, enumerate the mechanical and hydrodynamic factors of emulsion

<sup>1</sup> Tartar, Duncan, Shea and Ferrier: *J. Phys. Chem.*, 33, 435 (1929).

<sup>2</sup> Seifriz: *J. Phys. Chem.*, 29, 587 (1925).

<sup>3</sup> Stamm and Kraemer: *J. Phys. Chem.*, 30, 992 (1926).

systems which may be responsible for type determinations as "the particular mechanical treatment, character of the solid walls, volume composition, densities, viscosities, interfacial tensions and surface tensions (if a gas is present, as in shaking a partially filled bottle) of the liquids." Considering all these factors, generalities are dangerous and each emulsion system needs individual attention to produce the optimum conditions for stability.

Carbon tetrachloride, b. p.  $75.8^{\circ}$ - $76.2^{\circ}$ , was chosen as an "oil" of chemical and physical properties differing greatly from those of benzene. Its behavior in emulsions was very different from benzene. The results of attempts to determine accurately the temperature-concentration relations met with little success. In Table V are the data for one such attempt, when the conditions were similar to those obtaining in the aqueous sodium palmitate-benzene experiments.

TABLE V

Temperatures of Inversion of Water-in-Oil Emulsions to Oil-in-Water Emulsions using Carbon Tetrachloride and Aqueous Sodium Palmitate at Various Concentrations.

Temp.	Normality of Sodium Palmitate $\times 10^3$											
	1	2	3	4	5	6	7	8	9	10	20	30
0.0	B	B	B	B	WO	WO	WO	WO	WO	WO	WO	WO
2.5	B	B	OW	OW	B	B	WO	WO	WO	WO	WO	WO
5.0	B	B	OW	OW	OW	OW	WO	WO	WO	WO	WO	WO
7.5	B	OW	OW	OW	OW	OW	WO	WO	WO	WO	WO	WO
10.0		OW	OW	OW	OW	OW	OW	OW	OW	OW	WO	WO
12.5		OW	OW	OW	OW	OW	OW	OW	OW	OW	OW	WO
15.0		OW	OW	OW	OW	OW	OW	OW	OW	OW	OW	WO
17.5		OW	OW	OW	OW	OW	OW	OW	OW	OW	OW	WO
22.5		OW	OW	OW	OW	OW	OW	OW	OW	OW	OW	OW
25.0		OW	OW	OW	OW	OW	OW	OW	OW	OW	OW	OW

B indicates broke; no lasting emulsion formed.

The data of Table V were far from satisfactory. In the first place, the water-in-oil emulsions were very poor; the droplet size was large and irregular and did not approach the stability of the same type when benzene, xylene, toluene, etc., were used. There was less uniformity among the three vials of each soap concentration; the table shows inversion when at least two of the three were inverted. Long periods of shaking were found to change the temperature necessary for inversion, which indicated slower progress in the attainment of equilibrium in the systems.

The ratio of the volumes of the two phases appeared in preliminary experiments to play a part in the length of shaking time necessary for inversion. Therefore experiments involving concentrations, phase-volume, ratio, and the length or amount of shaking as variables, were performed. In Table VI, which records the results of one experiment, the ratios are indicated by the capital letters at the heads of the columns; the ratio of the volume of the aqueous

TABLE VI  
The Effects of Soap Concentration, Phase-Volume Ratio and Shaking Time on Carbon Tetrachloride-Aqueous Sodium Stearate Emulsions at 25°

Conc. V <sub>aq</sub> /V <sub>o</sub> Time	0.02					0.01					0.005				
	A	B	C	D	E	A	B	C	D	E	A	B	C	D	E
5	WO	WO	WO	WO	WO	OW	WO	B	WO	WO	OW	OW	OW	WO	WO
10	WO	WO	WO	WO	WO	OW	OW	B	WO	WO	OW	OW	OW	Oi	Oi
15	WO	OW	WO	WO	WO	OW	OW	OW	WO	WO	OW	OW	OW	Oi	Oi
20	OW	OW	WO	WO	WO	OW	OW	OW	WO	WO	OW	OW	OW	OW	Oi
25	OW	OW	WO	WO	WO	OW	OW	OW	WO	WO	OW	OW	OW	OW	Oi
35	OW	OW	OW	Oi	Oi	OW	OW	OW	Oi	Oi	OW	OW	OW	OW	Oi
45	OW	OW	OW	Oi	Oi	OW	OW	OW	Oi	Oi	OW	OW	OW	OW	Oi

TABLE VII  
The Effects of Soap Concentration, Phase-Volume Ratio and Shaking Time on Benzene Aqueous Sodium Stearate Emulsions at 25°

Conc. V <sub>aq</sub> /V <sub>o</sub> Time	0.02					0.01					0.005				
	A	B	C	D	E	A	B	C	D	E	A	B	C	D	E
5	WO	WO	WO	WO	WO	IP	WO	WO	WO	WO	OW	WO	WO	WO	WO
10	WO	WO	WO	WO	WO	IP	WO	WO	WO	WO	OW	WO	WO	WO	WO
15	WO	WO	WO	WO	WO	IP	WO	WO	WO	WO	OW	WO	WO	WO	WO
20	WO	WO	WO	WO	WO	IP	WO	WO	WO	WO	OW	WO	WO	WO	WO
25	WO	WO	WO	WO	WO	IP	WO	WO	WO	WO	OW	WO	WO	WO	WO
30	WO	WO	WO	WO	WO	IP	WO	WO	WO	WO	OW	WO	WO	WO	WO
40	WO	WO	WO	WO	WO	IP	WO	WO	WO	WO	OW	WO	WO	WO	WO
50	WO	WO	WO	WO	WO	IP	WO	WO	WO	WO	OW	WO	WO	WO	WO
60	WO	WO	WO	WO	WO	IP	WO	WO	WO	WO	OW	WO	WO	WO	WO

phase to the volume of the oil phase ( $V_{aq}/V_o$  was 7.5 to 2.5 in A, 6 to 4 in B, 5 to 5 in C, 4 to 6 in D, and 2.5 to 7.5 in E. The notation "Oi" indicates oil-in-water emulsions but emulsification incomplete. The emulsions were shaken 5 minutes at a time with approximately 5 minutes rest between.

Preliminary experiments with benzene showed no such variation, even on much longer shaking. Table VIII, however, was prepared in order to make certain of this important difference between the two organic liquids. Table VIII was prepared to supplement the data of Table VII; 0.005 normal sodium stearate was used through a wider range of phase volume ratios. Experiments on other organic liquids would no doubt show at least quantitative differences in these properties of emulsions. Because of the pronounced gelling of sodium soaps in benzene and the ease of examining its relation to emulsion type-determination, these higher saturated sodium soaps have been studied more extensively than the lower soaps of the same metal or the corresponding potassium soaps.

TABLE VIII

The Effects of Phase-Volume Ratio and Shaking Time on Benzene-Aqueous Sodium Stearate Emulsions at 25°

$\frac{V_{aq}}{V_o}$ Time	$\frac{9.5}{0.5}$	$\frac{7.5}{2.5}$	$\frac{5.0}{5.0}$	$\frac{2.5}{7.5}$	$\frac{0.5}{9.5}$
5	OW	OW	WO	WO	WO
10	OW	OW	WO	WO	WO
15	OW	OW	WO	WO	WO
20	OW	OW	WO	WO	WO
25	OW	OW	WO	WO	WO

#### Emulsions stabilized with Bivalent Soaps

Comparatively little experimental work has been done on water-in-oil emulsions stabilized by soaps of the bivalent and trivalent metals. Newman<sup>1</sup> tried to stabilize water-in-benzene emulsions through the use of the oleates of magnesium, zinc, nickel and calcium and found that only magnesium oleate gave satisfactory results. Mead and McCoy<sup>2</sup> studied some of the oil-soluble emulsifying agents but their results contributed but little to the general knowledge of water-in-oil emulsions. In the study of the inversion of oil-in-water emulsions stabilized with univalent soaps through the action of the salts of the bivalent and trivalent metals, no cognizance has been taken of the effect of the univalent salts produced by metathesis, on the stability of the resulting emulsion systems. These emulsions are usually unstable.

The present experimental work indicated that distribution of bivalent soaps between phases is also a governing factor of emulsion type. When dilute aqueous solutions of magnesium heptylate, magnesium caprylate, magnesium caproate or calcium valerate were shaken with equal volumes of benzene,

<sup>1</sup> Newman: J. Phys. Chem., 18, 45 (1914).

<sup>2</sup> Mead and McCoy: "Colloid Symposium Monograph," 4, 44 (1926).

oil-in-water emulsions were formed. These emulsions had different degrees of stability but persisted in some cases for 2 to 4 hours, which is longer than many water-in-oil emulsions last, whether they are made by inversion of a univalent soap emulsion or by the presence of the bivalent soap in the oil phase originally.

Water-in-oil emulsions were prepared through the use of more concentrated bivalent soap solutions in which solid or colloidal soap was present. These systems often broke completely within 10 or 15 minutes, the soap being largely precipitated in the non-aqueous phase. Inversion to the oil-in-water type was invariably accomplished by the addition of small amounts of water, followed by vigorous shaking. The addition of more benzene was found to favor the formation of water-in-oil emulsions.

Because of the small amounts of these soaps available, thorough quantitative studies on these reversal phenomena were impossible, but the qualitative observations support the belief that increasing the relative amount of soap in one of the phases tends to make that phase the dispersion medium of the emulsion. This may be accomplished by increasing the volume of such a phase (which changes the concentration of the soap in the other phase) or by a temperature change which favors the passage of the soap to that phase.

The oleates of calcium and magnesium are fairly easily dissolved by warm benzene; barium oleate seems to be the least soluble. When benzene solutions of these bivalent oleates were shaken with water the influence of the phase-volume relationship was very noticeable; the phase having the greater volume usually became the continuous one. A noteworthy observation was made when 5 cc of any of these oleate solutions in benzene were shaken with an equal volume of water. Gentle or moderate shaking invariably produced emulsions of the water-in-oil type while violent shakes by hand produced inversion to the oil-in-water type. The latter were the more stable, sometimes lasting for several hours, while the water-in-oil dispersions usually broke within 10 or 15 minutes. After breaking, the type of emulsion produced on subsequent shaking seemed entirely dependent on the mechanical treatment. The phenomenon was not greatly affected by temperature changes; oil-in-water emulsions seemed somewhat more easily produced at 60° than at 15°. Concentration of the soap in the benzene seemed to play a small part, because solutions of calcium oleate of 0.001, 0.005, 0.01, 0.02 and 0.05 volume normality were equally susceptible to the differences in methods of shaking.

A fact which apparently supports the colloidal or solid film theory of water-in-oil emulsifiers was observed during the experiments just reported. Without exception, flaky material was present in the benzene phase after the bivalent soap emulsions had broken. All that is needed to produce this phenomenon is to put *water in contact* with the benzene solution; shaking appeared only to hasten the precipitation. Dry benzene solutions of these soaps remained clear. The separation of the soap when the benzene became saturated or moist with water throws doubt on the assumption that solution of the bivalent soap in benzene is the cause for the inversion of oil-in-water to water-in-oil emulsions by electrolytes. There is no doubt, however, that the

precipitated or flocculent bivalent soap is more easily wetted by benzene than by water. The above objection obtains whether the bivalent soap is dissolved in the "oil" to start with or is produced through metathesis in an emulsion system. Water-in-oil emulsions have generally been reported as being unstable. This instability can be understood if fairly in-elastic, solid films, or films of little cohesive strength are responsible for the temporary emulsification. Electrolytes present in inverted emulsion systems would be expected to affect the permanency of colloidal films.

Contrary to current ideas, the oleates of calcium, magnesium and barium were found to be sufficiently soluble in water to stabilize oil-in-water emulsions.<sup>1</sup> These pure bivalent oleates were shaken in pyrex bottles with dis-

TABLE IX

Influence of Phase-Volume on Emulsion Type of Benzene Bivalent Oleate Systems at 25°

Soap	Phase-Volume Ratio, $V_{aq}/V_o$		
	8/2	5/5	2/8
MgOl <sub>2</sub>	OW	OW	Broke
CaOl <sub>2</sub>	OW	OW <sub>x</sub>	Broke
BaOl <sub>2</sub>	OW	OW <sub>x</sub>	Broke

x—required subsequent shaking by hand.

TABLE X

Influence of Phase-Volume on Emulsion Type of Benzene Bivalent Oleate Systems at 25°

Soap	Phase Volume Ratio, $V_{aq}/V_o$		
	8/2	5/5	2/8
MgOl <sub>2</sub>	OW	WO <sub>x</sub>	WO <sub>x</sub>
CaOl <sub>2</sub>	OW <sub>x</sub>	OW <sup>⊥</sup>	Broke
BaOl <sub>2</sub>	OW <sup>#</sup>	OW <sup>⊥</sup>	Broke

z—separated into 2 layers after 20 minutes.

#—Separated into 2 layers after 10 or 12 minutes.

⊥—required vigorous shaking by hand.

x—WO emulsions using MgOl<sub>2</sub> were the only ones of this type produced in this work which had the apparent droplet size and creaminess of OW emulsions, which confirms the experience of Newman<sup>2</sup> and of Parsons and Wilson.<sup>3</sup>

tilled water for 30 hours at 25°, after filtration the solutions were preserved in glass-stoppered pyrex bottles. Surprisingly good oil-in-water emulsions were produced when organic liquids were added in three 2 cc portions to 10 cc of these saturated aqueous solutions. The systems were shaken after each addition of the oil phase. With this phase-volume ratio, oil-in-water emulsions were formed with the following "oils" when they were shaken with aqueous

<sup>1</sup> Bhatnagar: J. Chem. Soc., 117, 542 (1920) obtained oil-in-water emulsions when olive oil was shaken with calcium hydroxide solutions of less than 0.002 normality; the type was found to depend in part on the phase-volume ratio.

<sup>2</sup> Newman: J. Phys. Chem., 18, 34 (1914).

<sup>3</sup> Parsons and Wilson: J. Ind. Eng. Chem., 13, 1116 (1921).

solutions of these bivalent oleates: carbon tetrachloride, chloroform, aniline, nitrobenzene, kerosene, benzene and toluene. The "oils" listed above are in the order of increasing stability of the emulsions.

The phase-volume influence on such systems was studied. The two phases of the respective systems were in contact 16 hours before they were given vigorous machine shaking for 15 minutes. The results are reported in Table IX.

Benzene solutions of these bivalent oleates (of unknown concentration) were prepared and placed in contact with distilled water for 16 hours. The phase volume influence was again ascertained, as before. The data are recorded in Table X.

The effect of electrolytes on the efficiency as emulsifiers of the oleates of calcium, magnesium and barium was investigated. Five cc of the saturated aqueous solutions of these soaps were shaken with 2 cc of benzene (which phase-volume relationship had been found to yield oil-in-water emulsions) and 1 cc of 1-normal electrolyte added. The time required for the first evidence of the separation of the emulsions into two phases was taken as an arbitrary standard of stability. The systems were given 5 violent shakes by hand and the time taken with a stop-watch. The results presented in Table XI are the means of 5 determinations.

TABLE XI  
Effects of Uni- and Bivalent Chlorides on Emulsions of Benzene stabilized by Some Bivalent Oleates

Salt Added Soap	None	NaCl	BaCl <sub>2</sub>	CaCl <sub>2</sub>	MgCl <sub>2</sub>
BaOl <sub>2</sub>	49	11	9	—	—
CaOl <sub>2</sub>	67	22	—	12	—
MgOl <sub>2</sub>	63	—	—	—	14
	cc 1-n	NaCl			
	1	2	3		
Time	60	53	33		

The data of Table XI prove the necessity of considering the presence of electrolytes when studying emulsion stability. Those emulsions containing no electrolyte persisted for more than an hour, while the others lasted less than 2 minutes. Regardless of the condition of the emulsifying agent in the oil-in-water emulsions, the results show them to be extremely sensitive to electrolytes. Such sensitivity is to be expected if the original emulsifying film is a colloid; the salts precipitate the colloids and the emulsions break. Water-in-oil emulsions were not formed after the addition of electrolytes in the systems just reported, because of the deficiency of suitable emulsifying material for this type of emulsion.

The above findings with bivalent soaps as emulsifying agents indicate the fallacy of drawing conclusions concerning their specific functions *when electrolytes of any type are present in the system*. The presence of solid or colloidal material in the non-aqueous phases whenever water-in-oil emulsions



are produced, supports the statement of Briggs,<sup>1</sup> that "in every case, investigation has shown that the apparently soluble emulsifier is in colloidal suspension in the outside phase of the emulsion and therefore constitutes a third phase in the system, exactly as a solid emulsifier can be seen to constitute a third phase in such systems. Furthermore, it is accepted by nearly everybody that the globules of liquids in all ordinary emulsions are invariably coated by some kind of film or pellicle which tends to prevent coalescence, and that this film or pellicle is present whether the emulsifier is apparently soluble or consists of a finely divided solid. In view of the vast majority of experimental evidence, it seems safe to assume that the presence of a film of emulsifying agent is absolutely essential to the existence of all ordinary emulsions."

The data presented here on the use of both univalent and bivalent soaps in the stabilization of either type of emulsion emphatically contradicts the oriented wedge theory<sup>2</sup> of emulsions. It neither contradicts nor supports the idea of orientation of the soap molecules at the dispersion interfaces but it does not allow the geometrical relations of the soap molecule to be the determining factor in the curvature of such interfaces. Such geometrical relations cannot, therefore be the type-determining factor of emulsions stabilized with soaps. As will be shown later, the emulsifying power of soaps probably depends on their colloidal properties; the effective colloidal properties of the solution are increased by adsorption of the surface-active colloid into the liquid-liquid interface. The result is a film or *third phase* appearing in the system which is capable of preventing coalescence of droplets, formed by mechanical means, and which appears to be in no way dependent on the relative diameters of the two ends of the soap molecule.

#### The Effects of Electrolytes on Emulsions

(a). *Inversion.* Robertson,<sup>3</sup> Newman,<sup>4</sup> Briggs and Schmidt,<sup>5</sup> Clowes,<sup>6</sup> Bhatnagar,<sup>7</sup> Parsons and Wilson,<sup>8</sup> and Ghosh and Dhar<sup>9</sup> have inverted stable *o*-in-water emulsions, stabilized by water-soluble alkali soaps, to the more unstable water-in-oil systems by the addition of salts of the bi- and trivalent metals. The work of Tartar, Duncan, Shea and Ferrier<sup>10</sup> has demonstrated a similar inversion in the case of certain sodium soaps, when sodium chloride is present in sufficient concentration. The mechanism of the reversal of phases

<sup>1</sup> Briggs: J. Ind. Eng. Chem., 13, 1008 (1921).

<sup>2</sup> Harkins, Davies and Clark: J. Am. Chem. Soc., 39, 586 (1917); Harkins and Keith: Science, 59, 463 (1924); Harkins and Beeman: Proc. Nat. Acad. Sci., 11, 631 (1925); Finkle, Draper and Hildebrand: J. Am. Chem. Soc., 45, 2780 (1923); Langmuir: J. Am. Chem. Soc., 39, 1848 (1917).

<sup>3</sup> Robertson: Kolloid-Z., 7, 7 (1910).

<sup>4</sup> Newman: J. Phys. Chem., 18, 34 (1914).

<sup>5</sup> Briggs and Schmidt: J. Phys. Chem., 19, 478 (1915).

<sup>6</sup> Clowes: J. Phys. Chem., 20, 407 (1916).

<sup>7</sup> Bhatnagar: J. Chem. Soc., 117, 542 (1920); 542 (1920); 119, 61 (1921).

<sup>8</sup> Parsons and Wilson: J. Ind. Eng. Chem., 13, 1116 (1921).

<sup>9</sup> Ghosh and Dhar: J. Phys. Chem., 30, 294 (1926).

<sup>10</sup> Tartar, Duncan, Shea and Ferrier: J. Phys. Chem., 33, 435 (1929).

has received some speculative attention from various investigators but about all that can be said with certainty concerning the phenomenon is that it is accompanied in each instance by the appearance in the emulsion system of soap, whose solubility in water is very low.

The work of Clowes has received rather wide-spread attention and has been used as a basis for a large part of the present-day emulsion theory. It is lamentable that he employed materials such as olive oil, whose composition is variable, and that he relied upon the very uncertain method of producing the emulsifying soap by having in the olive oil "sufficient oleic acid to form soap with all the NaOH introduced into the aqueous phase." Results to be given shortly are in direct contradiction with those reported by Clowes and prove that his interpretation does not apply to all soap emulsion systems. The writers believe that Clowes was led to his erroneous conclusion by the use of oil and a method which were open to question.

The principal thesis of his paper<sup>1</sup> seems to be an attempt to show that the molecular "100 to 1" ratio of sodium chloride to calcium chloride in a so-called "antagonistic effect," noticed in certain physiological systems, is effective in the establishment of "emulsion equilibrium." This antagonism is said to be manifested in the permeability of the soap film to water, sodium chloride making the emulsifying film more permeable to water and thus exerting a "destructive" effect on the film, while calcium chloride has a "protective" influence since it renders the film less permeable to water. It is proposed that these opposing influences are not the result of an antagonism between the cations involved but to "a balance between cations on the one hand, and anions on the other, adsorbed on or reacting with the soaps or other colloidal constituents of the surface films or membranes. It simply happens that, in the case of  $\text{CaCl}_2$ , the cation Ca is far more readily adsorbed than the anion Cl, while, in the case of NaCl, the anion Cl is somewhat more readily adsorbed than the cation Na." Although Clowes mentioned, in the above quotation, the possibility of the electrolyte "reacting with soaps—" the reported opposing influences of the two salts are subsequently entirely dealt with from the standpoint of preferential adsorption of the various ions by the soap film. Clowes found that sodium chloride in concentrations up to 0.1 M "promotes the adsorption of negative ions on the soap particles and consequently promotes the dispersion of soap in water, thus facilitating the formation of emulsions of oil dispersed in water." Of course what he meant to say, was, that since sodium chloride facilitated the formation of oil-in-water emulsions, it must be that negative ions were adsorbed on the soap particles.

If such a thing as "emulsion equilibrium" exists in systems containing both sodium and calcium chlorides, the condition should be reached by the addition of either salt to systems containing the other; and if the balancing ratio of 100 molecules of sodium chloride to 1 molecule of calcium chloride, as found by Clowes, is due to an ion-adsorption equilibrium, it should be present in all emulsion systems containing sodium oleate, sodium chloride

<sup>1</sup> Clowes: J. Phys. Chem., 20, 407 (1916).

and calcium chloride. Experiments were outlined and performed to test the validity of these points.

The data of Table XII show the type of emulsions produced when solutions of calcium chloride of various concentrations were added to oil-in-water emulsions whose aqueous phases contained sodium oleate of 0.01 normal concentration and sodium chloride of various concentrations, and whose dispersed oil phase was benzene. The final volume of each phase was 6 cc, the various components of the systems being added from burets. The concentrations indicated in the table are for the final aqueous phase and are expressed as volume normalities. Sodium oleate solution, water, sodium chloride solution and benzene were introduced into the vials in the order named, prior to emulsification. The calcium chloride solutions were then added.

TABLE XII

Effects of Sodium Chloride and Calcium Chloride on Emulsions of Benzene in Aqueous Sodium Oleate at 25°

NaCl (Normality)	CaCl <sub>2</sub> (Normality)						
	0.0	0.0001	0.0005	0.001	0.005	0.01	0.0125
0.0	OW	OW	OW	OW	OW <sub>x</sub>	WO	WO
0.05	OW	OW	OW	OW	OW <sub>x</sub>	WO	WO
0.10	OW	OW	OW	OW	OW	WO <sub>z</sub>	WO
0.15	OW	OW	OW	OW	OW	WO <sub>z</sub>	WO <sub>z</sub>

All WO emulsions were very unstable.

The presence of sodium chloride was without noticeable influence on the inverting action of calcium chloride. The importance of the equivalent concentrations of sodium oleate and calcium chloride at the inversion points should be emphasized. If Clowes' 100 to 1 molecular ratio is of general importance, breaking of the oil-in-water emulsions certainly should have taken place at the concentrations marked (x) and there should have been no inversion at the concentrations marked (z). There should have been no emulsion formed at calcium chloride concentration 0.005 normal when no sodium chloride was present, if sodium and calcium oleates have equal but opposite emulsifying properties; they were in equivalent proportions in that system. After standing 24 hours the oil-in-water emulsions had separated into 2 layers, the emulsion above an aqueous layer. With increasing calcium chloride concentration, the lower aqueous layers became increasingly turbid. The inverted systems broke in less than 30 minutes and on standing, the benzene layer became clear, except for flocculent material near the interface. The last emulsions of the last two columns separated into two practically clear layers, with considerable precipitated soap at the interface, showing *an additive rather than antagonistic effect* of sodium chloride to calcium chloride.

The interval between the concentrations of calcium chloride 0.005 to 0.01 normal was included in the experiment recorded in Table XIII. All other conditions were maintained as described for the data of Table XII.

TABLE XIII

Effects of Sodium Chloride and Calcium Chloride on Emulsions of Benzene in Aqueous Sodium Oleate at 25°

NaCl (Normality)	CaCl <sub>2</sub> (Normality)			
	0.006	0.007	0.008	0.009
0.0	OW	OW	OW <sub>x</sub>	OW <sub>z</sub>
0.05	OW	OW	OW <sub>x</sub>	OW <sub>z</sub>
0.10	OW	OW	OW <sub>x</sub>	OW <sub>z</sub>
0.15	OW	OW <sub>x</sub>	OW <sub>x</sub>	OW <sub>z</sub>

x—separated into 3 layers; benzene, oil-in-water emulsion, water.

z—gentle shaking produced WO but when these were broken and the emulsions were given violent shaking by hand, OW were produced, which separated into 3 layers after 10 minutes.

Table XIII shows evidence of an additive effect of the two chlorides on the breaking of these emulsions. The last system of the first column and the last two of the second column were practically identical with the first two of the third column after standing 4 days. The calcium chloride introduced apparently converted its equivalent of sodium oleate into calcium oleate, while the sodium chloride in 0.10 and 0.15 normal concentrations was beginning to exert its salting-out effect on the remaining sodium oleate. The complete salting-out of soaps occurs at a still higher sodium chloride concentration and is apparently independent of the concentration of the soap.<sup>1</sup>

TABLE XIV

Effects of Sodium Chloride and Calcium Chloride on Emulsions of Benzene in Aqueous Sodium Oleate at 25°

NaCl (Normality)	CaCl <sub>2</sub> (Normality)			
	0.001	0.005	0.010	0.0125
0.0	OW	OW	WO	WO
0.05	OW	OW	WO	WO
0.10	OW	OW	WO	Broke
0.15	OW	OW	WO	Broke

All WO emulsions were unstable.

Experiments were performed in which the order of addition of the sodium and calcium chlorides were interchanged; i.e., the calcium chloride was added prior to emulsification, the sodium chloride afterward. Only the concentrations of calcium chloride 0.005 and 0.01 normal were investigated because from the previous experiments one was below, the other approximately at, the critical concentration for this system. The concentrations and conditions of the experiment were of the standard type described for Table XII. Good oil-in-water emulsions were produced at the lower calcium chloride concentration even before the addition of sodium chloride, whereas unstable water-in-oil dispersions resulted from the use of 0.1 normal calcium chloride, on which the addition of sodium chloride had no apparent effect.

<sup>1</sup> McBain and Pitter: J. Chem. Soc., 1926, 893; Parsons and Wilson: J. Ind. Eng. Chem., 13, 1116 (1921).

One set of experiments was performed in which all components of the emulsion systems were placed in the vials before emulsification by shaking was accomplished, other conditions remaining as before. The results are reproduced in Table XIV.

The only effect of the presence of sodium chloride on the action of calcium chloride in the above systems was noticed before emulsification. The calcium oleate precipitates in those tubes containing sodium chloride, were much more curdy than the precipitates in the absence of the sodium salt. From the similarity of Tables XII and XIV this difference was without consequence.

The additive properties of sodium and calcium chlorides on the breaking and inverting of emulsions stabilized with sodium oleate, was even more pronounced when carbon tetrachloride was used in place of benzene. Table XV records the results of an experiment in which calcium chloride was added after the carbon tetrachloride had been emulsified in the aqueous phase which contained both oleate and chloride of sodium. Before emulsification, a pronounced precipitating effect of sodium oleate by carbon tetrachloride was noticed in all the systems containing sodium chloride in 0.15 normal concentration.

TABLE XV

Effects of Sodium Chloride and Calcium Chloride on Emulsions of Carbon Tetrachloride in Aqueous Sodium Oleate at 25°

NaCl (Normality)	CaCl <sub>2</sub> (Normality)					
	0.005	0.006	0.007	0.008	0.009	0.010
0.0	OW	OW	OW	IP	WO	WO
0.05	OW	OW	IP	IP	WO	WO
0.10	OW	OW <sub>x</sub>	IP	IP	WO	WO
0.15	OW <sup>+</sup>	WO	WO	WO	WO	WO <sub>z</sub>

x—after 1/2 hour showed signs of IP.

+—after 1-1/2 hour showed signs of IP.

z—separated into 3 layers after 2 hours; showed precipitating effect of NaCl.

Time is a factor in the breaking of these emulsions. After 2 days the inversion point moves toward the left of the table; i.e., after 2 days the last system of the first column, and the second and third of the second column were clearly at the inversion point (IP), while the third systems of the third and fourth columns had broken to yield water-in-oil emulsions on shaking.

Interchanging the order of addition the sodium and calcium chlorides seemed to have a slight effect on the stability of the emulsions produced, but the effect was different from what might be expected. The precipitating effect of sodium chloride on these systems was more retarded than in the previous case. Table XVI shows the condition of the systems after 2 hours standing. Good oil-in-water emulsions were prepared in the presence of calcium chloride up to and including concentrations 0.008 normal; above 0.008 normal, unstable water-in-oil systems were produced. The emulsions stood 16 hours before the sodium chloride solutions were added.

TABLE XVI

Effects of Sodium Chloride and Calcium Chloride on Emulsions of Carbon Tetrachloride in Aqueous Sodium Oleate at 25°

NaCl (Normality)	CaCl <sub>2</sub> (Normality)					
	0.005	0.006	0.007	0.008	0.009	0.010
0.0	OW	OW	OW	IP	WO	WO
0.05	OW	OW	OW <sub>x</sub>	IP	WO	WO
0.10	OW	OW <sub>x</sub>	OW <sub>x</sub>	IP	WO	WO
0.15	OW <sub>x</sub>	OW <sub>x</sub>	IP <sub>z</sub>	IP	WO	WO

x—at IP after 5-10 days.

z—WO, after 5 days.

The conditions of the respective emulsions of Tables XV and XVI were practically identical throughout, after 10 days.

Although the salting-out of potassium soaps by potassium salts is more difficult than with corresponding sodium systems, potassium chloride did have a slight additive effect to that of barium chloride on emulsions of benzene in aqueous potassium oleate. In Table XVII are given the types of emulsions resulting when barium chloride solutions of various strengths were added to emulsion systems containing different potassium chloride concentrations. The final potassium oleate concentration was 0.01 normal.

TABLE XVII

Effects of Potassium Chloride and Barium Chloride on Emulsions of Benzene in Aqueous Potassium Oleate at 25°

KCl (Normality)	BaCl <sub>2</sub> (Normality)						
	0.0	0.005	0.006	0.007	0.008	0.009	0.010
0.0	OW	OW	OW	OW	IP	WO	WO
0.1	OW	OW	OW	OW	IP	WO	WO
0.2	OW	OW	OW	OW	IP	WO	WO
0.3	OW	OW	OW	OW	IP	WO	WO
0.4	OW	OW	OW	IP	IP	WO	WO
0.5	OW	OW	OW	IP	IP	WO	WO

The experiments recorded in Tables XII to XIV strip Clowes' so-called "emulsion equilibrium" of its appearance of generality and suggest that the explanation of the phenomenon he observed is to be found in the uncertainties of his complex emulsion systems. The instability of the systems reported here as the equivalent concentration of calcium chloride approaches that of sodium oleate, and the breaking and inverting of the systems when these concentrations become equal, regardless of the presence of sodium chloride, demonstrate that the complete conversion of the water-soluble soap present to one much less soluble in water, is the underlying cause of the breaking and inverting of these emulsions. The present work confirms the results obtained by Parsons and Wilson<sup>1</sup> who found that the determining factor in inverting

<sup>1</sup> Parsons and Wilson: J. Ind. Eng. Chem., 13, 1116 (1921).

Nujol-sodium oleate oil-in-water emulsions by magnesium salts was the ratio of the *equivalents* of magnesium to sodium. The ions "reacting with the soaps" rather than those "adsorbed on" thus appear to be the true inversion agents.

(b). *Interfacial Tension.* Since the work of Quincke<sup>1</sup> and Donnan<sup>2</sup> the importance of low interfacial tension between emulsion phases to the ease of emulsification and the stability of the resulting emulsions, has been realized. It is without the province of this paper to review the literature (which is quite abundant) on this phase of the emulsion problem, but the reader is referred to Clayton's<sup>3</sup> résumé. The determination of interfacial tensions of some emulsion systems which had suffered inversion through the influence of electrolytes was the extent of the work to be herein reported.

Although sodium chloride is negatively adsorbed at the air-water interface, causing an increase in the surface tension of the liquid against air, and although it causes a slight increase in the interfacial tension of water against benzene,<sup>4</sup> its presence in solution of sodium oleate greatly lowers the interfacial tension against benzene.<sup>5</sup> Clowes<sup>6</sup> found that sodium chloride in the alkali solutions which he used, greatly increased the drop number against olive oil, which indicated a decrease in interfacial tension. Since the work of Tartar, Duncan, Shea and Ferrier<sup>7</sup> has shown the inverting action of sodium chloride in certain instances, one of their reproducible systems was chosen for study of the interfacial tension. One of Bhatnagar's<sup>8</sup> systems was duplicated and the interfacial tension change produced by the addition of barium nitrate to sodium oleate solutions was likewise studied, while a new system of potassium stearate, potassium chloride and benzene was investigated.

An instrument patterned after that of Fahrenwald<sup>9</sup> was built. The scale was calibrated in grams and when using an interfacial tension blade of 2.13 centimeters in length, the readings of the instrument were accurate to 0.06 dyne. With this instrument the interfacial tension of mutually saturated benzene-water, was found to be 34.87 dynes at 25°. Harkins and Zollman<sup>10</sup> reported 35.00 dynes for the same tension at 20°, when they used the modified drop-weight method.

The equilibrium systems of aqueous sodium oleate, sodium chloride and benzene were prepared by overlaying 2 percent sodium oleate solutions with benzene and then adding aqueous sodium chloride to give the concentrations

<sup>1</sup> Quincke: Wied. Ann., 35, 589 (1888).

<sup>2</sup> Donnan: Z. physik. Chem., 31, 42 (1899).

<sup>3</sup> Clayton: "Theory of Emulsions," 2d Ed., 63 (1928).

<sup>4</sup> Harkins and Humphrey: J. Am. Chem. Soc., 38, 242 (1916).

<sup>5</sup> Harkins and Zollman: J. Am. Chem. Soc., 48, 69 (1926).

<sup>6</sup> Clowes: J. Phys. Chem., 20, 407 (1916).

<sup>7</sup> Tartar: Duncan, Shea and Ferrier: J. Phys. Chem., 33, 435 (1929).

<sup>8</sup> Bhatnagar: J. Chem. Soc., 119, 61 (1921).

<sup>9</sup> Fahrenwald: J. Optical Soc. America, 6, 722 (1922).

<sup>10</sup> Harkins and Zollman: J. Am. Chem. Soc., 48, 69 (1926).

indicated in Table XVIII and to reduce the sodium oleate concentrations to 1 percent. The systems were brought to equilibrium by rotating them gently by hand at intervals for 16 hours. At the end of that time, clear samples from each of the immiscible layers were pipetted off and the interfacial tensions measured at 23°. Figure 3 shows graphically the interfacial tension changes.

All the interfacial tension values reported in Table XVIII are the means of at least 5 determinations except the third, which is for 4 determinations. When making the measurements on the third system, considerable spontaneous emulsification took place, which interfered with the accuracy of the measurements. Simultaneous emulsification tests showed that if none of

TABLE XVIII

Interfacial Tension of Benzene-Sodium Oleate Equilibrium Systems containing Various Amounts of Sodium Chloride

NaCl (Normality)	Interfacial Tension (Dynes)	NaCl (Normality)	Interfacial Tension (Dynes)
0.0	1.90	0.4	0.56
0.2	0.82	0.5	0.83
0.3	0.43		

the solid soap were present, emulsions could not be obtained when equal volumes of the two phases of the last three systems were shaken together. Introduction of some of this precipitated soap favored the formation of rather unstable water-in-oil emulsions. The first two systems gave oil-in-water emulsions. The value 1.90 dynes for the interfacial tension of the equilibrium system containing no sodium chloride falls exactly on the curve of the data obtained by Harkins and Zollman<sup>1</sup> for 1 percent (0.033 normal) sodium oleate against benzene.

Table XIX records the interfacial tensions of benzene against 0.5 percent potassium stearate solutions containing various concentrations of potassium chloride. The presence of crystalline potassium stearate in the aqueous phases may have vitiated the values obtained but this solid soap was present when emulsification was produced with these systems; consequently the values have been reported here. The determination were carried out as with sodium oleate. See also Fig. 3.

TABLE XIX

Interfacial Tension of Benzene-Potassium Stearate Equilibrium Systems containing Various Amounts of Potassium Chloride

KCl (Normality)	Interfacial Tension (Dynes)	KCl (Normality)	Interfacial Tension (Dynes)
0.0	2.76	0.6	x
0.2	x	0.8	2.78
0.4	x	1.0	4.38

x—spontaneous emulsification prevented measurements.

<sup>1</sup> Harkins and Zollman: J. Am. Chem. Soc., 48, 69 (1926).



Below potassium chloride concentration 0.8 normal the interfacial tensions were too small to be measured and oil-in-water emulsions were easily formed; solutions containing potassium chloride in concentrations ranging from 0.8 to 2.0 normal gave unstable water-in-oil emulsions, those of the higher concentrations being the most stable.

Bhatnagar<sup>1</sup> found that emulsions of 10 cc. paraffin oil in 10 cc. of sodium oleate solutions containing 0.080, 0.150, and 0.210 millimols of the soap could be inverted by the presence of 0.0398, 0.080 and 0.112 millimols, respectively, of barium nitrate. These systems were duplicated, using benzene, together with systems containing the same amounts of sodium oleate but in which

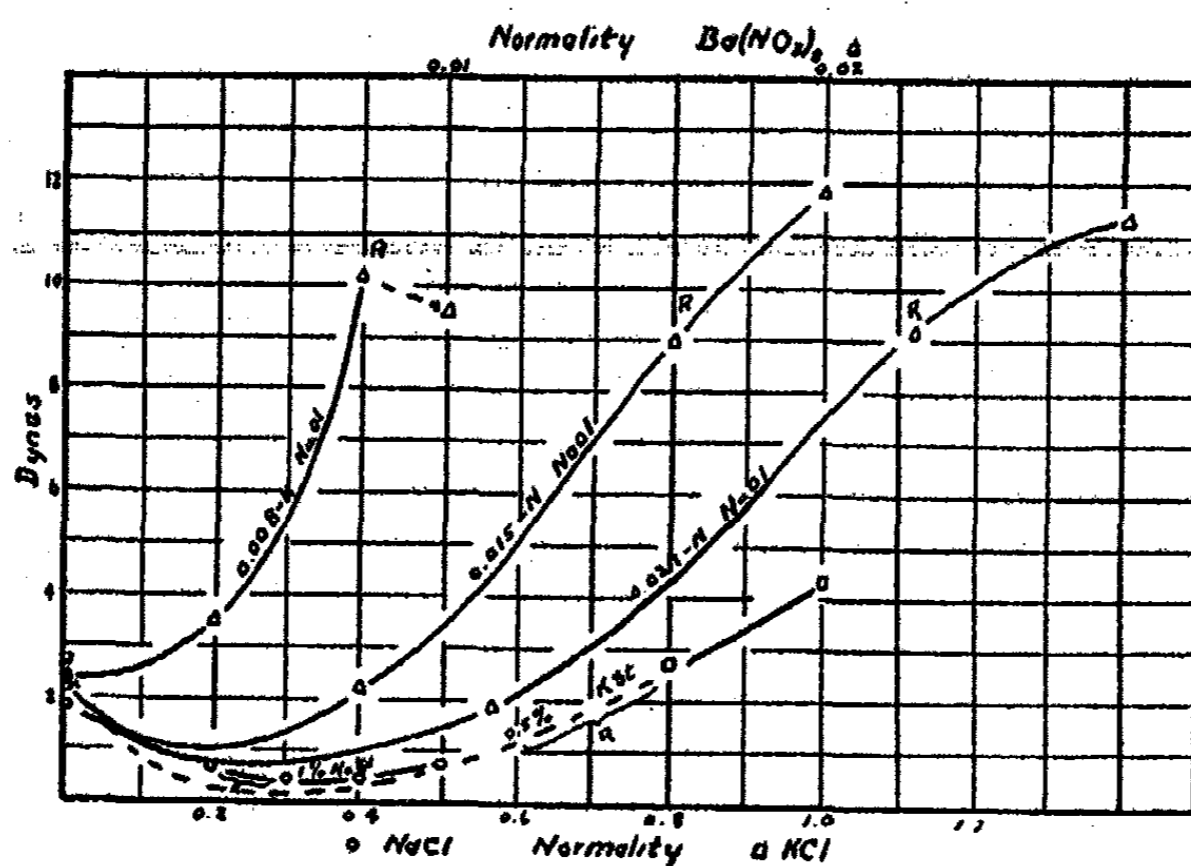

FIG. 3

there was only one-half the amount of barium nitrate necessary for the inversion of the respective emulsions, as reported by Bhatnagar. Similar systems containing 1-1/4 the inversion concentrations (R) of barium nitrate, were also prepared. Table XX records the interfacial tensions in dynes of these various systems, when determined in similar manner to those of Table XV. See also Fig. 3.

TABLE XX

Interfacial Tensions of Benzene-Sodium Oleate Equilibrium Systems containing Various Amounts of Barium Nitrate

NaOl Millimols	Ba(NO <sub>3</sub> ) <sub>2</sub>			
	0.0	1/2 R	R	1-1/4R
0.080	2.4X	3.58	10.26	9.56
0.150	2.2X	2.27	8.95	11.81
0.210	2.1X	1.90	9.17	11.34

x—values taken from data of Harkins and Zollman: J. Am. Chem. Soc., 48, 69 (1926).

<sup>1</sup> Bhatnagar: J. Chem. Soc., 119, 61 (1921).

Confirmatory emulsification tests produced oil-in-water emulsions for each  $1/2$  R barium nitrate concentration, and unstable inverted systems at R and  $1-1/4$  R concentrations. Much more stable water-in-oil emulsions were obtained when solid sodium nitrate was added to emulsions containing  $1/2$  R barium nitrate than when inversion was accomplished by barium nitrate alone.

Although the scope of the interfacial tension values reported here is not sufficiently great to allow extended interpretation, the data indicate that something besides low interfacial tension is necessary for the production of stable emulsions. From the emulsification tests in connection with the systems reported in Table XVIII the opinion is hazarded that one further requirement is the presence of a third phase which is capable of preventing coalescence of the dispersed droplets. Various statements occurring in the literature, which will be reviewed shortly, make it appear that colloidal soap adsorbed into the interfaces of emulsion systems is responsible for the stabilization of the oil-in-water type of emulsion. The presence of colloidal or solid material, insoluble in either phase, but which may be adsorbed into the interfaces of systems which yield water-in-oil emulsions, strongly suggests that emulsions of the latter type, produced by salting-out of the water-soluble emulsifier or by the reaction of bi- and trivalent metal salts, are stabilized for brief periods by films or skins of this finely divided solid material. The suggested reason for the comparative instability of these water-in-oil systems has already been discussed.

#### Discussion

The effects of electrolytes on oil-in-water emulsions stabilized by soaps should be interpreted in the light of the effects of electrolytes on solutions of soaps alone. The presence of the dispersed oil droplets may modify the behavior of the soap solution to a certain extent. The writers believe, however, that a short survey of the behavior of soap solutions in the presence of electrolytes may prove helpful in arriving at an understanding of their behavior in emulsions.

Soaps which are comparatively insoluble in water are produced when salts of the polyvalent metals are added to solutions of alkali soaps. Bhatnagar<sup>1</sup> maintains that the relationship between salt and soap in such instances is not stoichiometric; that adsorption compounds containing an excess of polyvalent metal ions over sodium or potassium ions in a monovalent soap, are formed. Any divergence from stoichiometric relations is, however, more likely to be due to occlusion by the curdy soap precipitate. In Bhatnagar's own work<sup>2</sup>, in that of Parsons and Wilson<sup>3</sup>, and in data presented here, salt and soap appear in equivalent proportions at the inversion point of emulsions. The precipitation of the insoluble soap removes the emulsifying film of the oil-in-water emulsion, which is consequently broken. Shaking then produces

<sup>1</sup> Private communication.

<sup>2</sup> Bhatnagar: J. Chem. Soc., 119, 61 (1921).

<sup>3</sup> Parsons and Wilson: J. Ind. Eng. Chem., 13, 1116 (1921).

the opposite type of emulsion, probably through the functioning of the precipitated soap as a solid emulsifier, more wetted by oil than by water. The complete solubility in the oil phase has been shown to be doubtful.

The numerous and extensive studies by McBain<sup>1</sup> and his co-workers have demonstrated the exceeding complexity of alkali soap solutions and have advanced several lines of evidence to prove the existence of colloidal material in all solutions except the very dilute. This colloid may be present as ionic or neutral micelles. Salmon<sup>2</sup> has shown that the addition of salts in small amounts reduces the proportion of ionic micelles and increases that of the neutral colloid. McBain<sup>3</sup> states that the effect of the addition of electrolytes with a common alkali is first to increase the formation of micelles if many simple ions are still present; second, to drive back dissociation and change the composition of the micelles and third, to diminish the hydration of the micelles. King<sup>4</sup> has studied the increased viscosities of soap solutions when electrolytes are added and Fischer and Hooker<sup>5</sup> have obtained interesting results on the viscosity increase as a preliminary step to the salting-out of soaps by various electrolytes. McBain, Willavoys and Heighington<sup>6</sup> have made a thorough investigation of the viscosity increase in the case of sodium palmitate. The enormous increase in viscosity is explained to be the result of partial dehydration (a concentrating effect) of the micelles and the increased amount of colloidal material. Fischer and Hooker state that the initial increase in viscosity occurs at the same potassium ion concentrations, when potassium oleate is salted out by potassium salts of different anion valencies, while McBain and Pitter<sup>7</sup> conclude that in the completed salting-out of soaps "the salts do not replace each other equivalent for equivalent, but rather mol for mol, irrespective of their valency." It is the universal observation that a great decrease in the viscosity of the soap attends the addition of the last of the salt required to salt-out the soap.

Bhatnagar<sup>8</sup> is to be credited with perhaps the most accurate published work on the inversion of emulsions by electrolytes. In the last paper just referred to he says that "it is difficult to draw hard and fast lines between the effects of univalent electrolytes and bi- and ter-valent electrolytes on soap solutions, as both of these are adsorption phenomena. On the solubility hypothesis sodium chloride ought to be capable of changing the type of emulsion as well as barium chloride. This is, however, contrary to all experience and the multivalent ions alone are known to cause reversal of type." If these effects were really simple adsorption phenomena, then it *should be possible*

<sup>1</sup> McBain: "The Study of Soap Solutions," Chap. XVI, Bogue's "Colloidal Behavior," 410 (1924).

<sup>2</sup> Salmon: J. Chem. Soc., 121, 711 (1922).

<sup>3</sup> McBain: Rep. Brit. Ass. Adv. Sci., 1920, 1-154A.

<sup>4</sup> King: J. Soc. Chem. Ind., 41, 147T (1922).

<sup>5</sup> Fischer and Hooker: "Soaps and Proteins," 116 (1921).

<sup>6</sup> McBain, Willavoys and Heighington: J. Chem. Soc., 1927, 2689.

<sup>7</sup> McBain and Pitter: J. Chem. Soc., 1926, 893.

<sup>8</sup> Bhatnagar: J. Chem. Soc., 117, 542 (1920); 119, 61, 1766 (1921).

"to draw hard and fast lines" between uni- and polyvalent ions. Furthermore, Tartar, Duncan, Shea and Ferrier<sup>1</sup>, and Lothrop and Pettengill<sup>2</sup> in this laboratory have made some quantitative studies on the inversion of emulsions by salts of the same metal as the soap. Mead and McCoy<sup>3</sup> reported such an observation but evidently did not carry through complete experimental tests on the phenomenon.

From the abundance of evidence presented on the increase of the colloidal nature of soap solutions together with that which indicates the stabilizing influence of small amounts of sodium chloride on sodium soap emulsions<sup>4</sup> it seems that soap owes its emulsifying power primarily to its colloidal nature and that by increasing these colloidal properties, sodium chloride in small amounts thus promotes oil-in-water emulsion stabilization. Harkins and Zollman<sup>5</sup> have shown that sodium chloride reduces remarkably the benzene-aqueous sodium oleate interfacial tension. This is due to the increased adsorption of the surface-active sodium oleate in the presence of the chloride, as was shown to take place through the work of Dubrisay<sup>6</sup>. Thermodynamically, the lower interfacial tension makes the extension of the interface by the formation of droplets easier, but the stabilization of these droplets has been shown to depend upon still other factors.

Sodium chloride probably does not have the antagonistic effect for calcium chloride attributed to it by Clowes; it does lower the interfacial tensions of soap solutions against oil phases, but this in no wise interferes with the precipitation of the soap on the addition of salts of polyvalent metals. Either alkali salts or salts of polyvalent metals, when present in soap solutions in sufficient quantities, produce soaps which are insoluble in water and stabilize water-in-oil emulsions if they are sufficiently wetted by the oil phase.

Because the physico-chemical reasons for the inversion of emulsions by electrolytes are still in doubt, the complete explanation of emulsification when soaps are used for stabilizers, is at present lacking. Few aspects of the emulsion problem are so intriguing as inversion because of its fundamental relationship to emulsion theory. However, as has been pointed out before, the tendency to generalize has been a pitfall in the theoretical treatment of emulsions. There are too many possible variables in a system so complex as an emulsion to lay too much general emphasis upon the results of any one study.

### Summary

1. The distribution of soap emulsifiers between the immiscible phases of emulsions is a type-determining factor of such systems; it applies to soaps of both univalent and polyvalent metals.

<sup>1</sup> Tartar, Duncan, Shea and Ferrier: *J. Phys. Chem.*, 33, 435 (1929).

<sup>2</sup> Tartar, Lothrop and Pettengill: *J. Phys. Chem.*, 34, 000 (1930).

<sup>3</sup> Mead and McCoy: "Colloid Symposium Monograph," 4, 44 (1926).

<sup>4</sup> Clayton: "Margarine," 72, (1920); Ayres: *Chem. Met. Eng.*, 22, 1061 (1920); Herschel: *U. S. Bur. Standards Tech. Papers*, No. 66, 17 (1917).

<sup>5</sup> Harkins and Zollman: *J. Am. Chem. Soc.*, 48, 69 (1926).

<sup>6</sup> Dubrisay: *Compt. rend.*, 182, 1217 (1926).

2. Distribution of soap is controlled by factors influencing solubility and wettability, such as temperature, phase-volume relationships, mechanical treatment, the presence of electrolytes, etc.

3. Oil-in-water emulsions are stabilized by soaps that are chiefly present in the aqueous phase; the soaps are probably colloidal at the interfaces of such emulsions. Soaps that are more easily wetted by the "oil", or are chiefly in solid or colloidal condition in the non-aqueous phase, temporarily stabilize water-in-oil emulsions. These conditions apply to soaps of both univalent and polyvalent metals. The concentration of soap at emulsion interfaces may be regarded as constituting a third phase of the system.

4. Low interfacial tensions aid the dispersion of droplets of one liquid in another, but must be accompanied by material capable of forming permanent films around the droplets, in order that the emulsion be stable.

*Chemistry Department,  
University of Washington,  
Seattle, Washington,  
July 1, 1929*

## THE RELATION BETWEEN ACIDS AND PECTIN IN JELLY FORMATION

BY GENE SPENCER

An "optimum acidity" range for fruit jelly-making by the hot method has been reported by different workers. Tarr<sup>1</sup> has attached pectin-acid compound significance to this and supports his hypothesis by a series of experiments in which the number of cc. of different acids required to give a definite pH value to a 1% pectin sol is taken as criterion of stoichiometric relation between pectin and the acids used.

We have already seen that the "optimum acidity" for jelly-making with sugar denotes a characteristic of the hot evaporation method and not of pectin.

Tarr's conclusion derived from sugar-free pectin sols treated with different acids should be considered carefully since it involves an important colloid principle.

The data to be studied were obtained by Tarr (page 20) as follows: "The acids were added in small accurately measured quantities to 100 cc. of distilled water, hydrogen ion concentrations being determined after each addition of acid. The acids were then added in a similar manner to 100 cc. of distilled water in which 1 g. of pectin was dissolved, hydrogen ion concentrations being determined as before. It should be mentioned here that all hydrogen ion concentrations for this work were calculated from potentials that were measured with a Leeds and Northrup Type K potentiometer."

For the purpose of more careful study Table VIII of Tarr's paper is transferred to Table I below:

The data of this table were interpreted by Tarr (page 23) as follows: "It will be observed that the effect of each acid is different. For example, to produce a hydrogen ion concentration of pH 3.50 with the pectin dissolved in the water requires approximately 2.6 cc. of 0.1 N sulphuric acid, as compared with 5.5 cc. of 0.1 N tartaric acid, 7.5 cc. of 0.1 N phosphoric acid, or 8.5 cc of 0.1 N citric acid. The total amount of acid that is required varies with the particular acid employed.

"Furthermore, there is a purely stoichiometrical relation existing between the combining power of the acids and the effect that they produce on the hydrogen ion concentration with pectin present in the solution. It is a relation that is based on the actual combining ability of the various acids. Loeb has already shown that this same relationship exists between proteins and acids, and, in our presentation, we make frequent recourse to his interesting discussions.

"Weak dibasic or tribasic acids give off one hydrogen more readily than both or all three, depending entirely on the hydrogen ion concentration of the

<sup>1</sup> Univ. of Del. Expt. Sta. Bull., 134, (1923).

TABLE I

(Table VIII from Tarr)

The Effect of Various 0.1 Normal Acids on Distilled Water (100 cc) and on Distilled Water (100 cc) + 1 g. of Pectin

I.	2.	3.	4.	5.	6.	7.	8.	9.	10.	11.
Acid Added cc.	Water + Sulphuric Acid pH	Water + Sulphuric Acid + Pectin pH	Water + Phosphoric Acid pH	Water + Phosphoric Acid + Pectin pH	Water + Tartaric Acid pH	Water + Tartaric Acid + Pectin pH	Water + Citric Acid pH	Water + Citric Acid + Pectin pH	Water + Acetic Acid pH	Water + Acetic Acid + Pectin pH
0	5.50	4.21	5.50	4.17	5.50	4.22	5.50	4.16	5.50	4.20
1	3.06	4.06	3.55	4.05	—	—	—	—	—	—
2	2.81	3.64	3.28	3.95	3.13	3.88	3.35	4.04	—	—
3	2.64	3.41	3.15	3.84	—	—	—	—	—	—
4	2.53	3.21	3.00	3.77	2.93	3.63	3.15	3.76	—	—
5	2.47	3.04	2.92	3.68	—	—	—	—	—	—
6	2.41	2.89	—	3.60	2.84	3.45	3.04	3.64	—	—
7	2.33	2.77	2.81	3.54	—	—	—	—	—	—
8	—	2.65	—	3.46	2.80	3.33	2.97	3.54	—	—
9	2.25	2.58	2.73	3.40	—	—	—	—	—	—
10	—	2.50	—	3.34	2.73	3.26	2.91	3.46	3.43	3.78
11	2.18	2.44	2.68	3.29	—	—	—	—	—	—
12	—	2.39	—	3.24	—	3.17	—	—	—	—
13	2.13	2.34	2.63	3.19	—	—	—	—	—	—
14	—	2.31	—	3.14	2.67	3.12	2.83	3.34	—	—
15	2.08	2.27	2.59	3.09	—	—	—	—	—	—
16	—	—	—	—	—	3.07	—	—	—	—
18	—	—	—	—	2.61	3.01	2.76	3.25	—	—
20	1.97	2.14	2.52	2.91	—	2.98	—	—	3.25	3.64
22	—	—	—	—	2.58	2.96	2.72	3.16	—	—
24	—	—	—	—	—	2.92	—	—	—	—
25	1.92	—	2.44	2.79	—	—	—	—	—	—
26	—	—	—	—	2.55	2.88	2.68	3.11	—	—
28	—	—	—	—	—	2.85	—	—	—	—
30	1.88	—	2.39	2.71	2.54	2.83	2.67	3.06	3.18	3.56
35	1.81	—	2.36	2.62	—	—	—	—	—	—
40	1.78	—	2.31	2.55	2.49	2.74	2.60	2.97	3.13	3.48
45	1.75	—	2.29	2.49	—	—	—	—	—	—
50	—	—	—	—	2.43	2.67	2.54	2.89	3.07	3.44

solution. At the hydrogen ion concentration that we employ, there would be only one hydrogen liberated from such acids. With a strong dibasic acid like sulphuric acid, however, both hydrogens are held with so small an electrostatic force that even at a hydrogen ion concentration of pH 3, or considerably below, the acid liberates both hydrogens. The action of sulphuric acid would consequently be similar to that of a strong monobasic acid like

hydrochloric. It would follow, therefore, that at the hydrogen ion concentrations employed in these investigations, three times as many cc. of 0.1 N phosphoric acid should be required to produce a given pH as are required of 0.1 N sulphuric acid. And in the same manner, twice as many cc. of 0.1 N tartaric acid and three times as many cc. of 0.1 N citric acid should be required.

"From the data presented in Table VIII (Table I above), it will be observed that the relations just described are quite closely maintained. For convenience, let us establish the given pH at 3.50. Approximately 2.6 cc. of 0.1 N sulphuric acid are required to produce pH 3.50, while approximately 7.5 cc. of 0.1 N phosphoric acid are required to produce the same value. This maintains rather closely the 1:3 ratio that should exist between these two acids. About 5.5 cc. of 0.1 N tartaric acid are required, as compared with 2.6 cc. of 0.1 N sulphuric acid, a proportion that approximates the 1:2 ratio that should exist. This is not an exact relation, however, and when citric acid is compared, it will be observed that there is an even wider variation between the ratio that exists and the 1:3 ratio that we said should exist; 10 cc. of 0.1 N citric acid are required as compared with the 2.6 cc. of 0.1 N sulphuric acid. About 45 cc. of 0.1 N acetic acid are required to produce a hydrogen ion concentration of pH 3.50."

The number of cc. of different acids compared in the above discussion were obtained by mathematical interpolation on the assumption that the curve between any two points is a straight line, as perhaps it is within the limit of experimental error. To avoid the necessity of this interpolation, however, and to be able to see the data more completely in this respect, Table II has been arranged from the odd columns of Table I. These odd columns represent the pH value resulting from increasing the size of the added increments of sulphuric, citric and tartaric acids. Acetic acid is not considered since it offers no basis for comparison, and Tarr omits it from discussion.

Since the pH measurements on the same pectin sol to which no acid was added do not agree within 0.03 points from the average, this variation was taken as the recognized experimental limitation of the series. Accordingly pH values varying within this limit were taken as comparable and their average recorded in the first column of Table II.

The number of cc of the different acids which, added to the pectin sol, gave it the designated pH values, have been copied from Table I to the "Used" column of Table II.

The calculated number of cc of each acid which bears the claimed stoichiometric relation to the number of cc of sulphuric acid used, is recorded in the "Calculated" column. There is no "Calculated" column for sulphuric acid since the number of cc "used" of this acid was chosen as the basis for the stoichiometric comparison.

The data for each acid of Table II are conspicuously separable into the two groups divided by the horizontal divisions. Above this dividing line the theoretical ratio holds within a fraction of a cubic centimeter in 7 out of 10 cases. Below the line of division, the ratio fails completely.



TABLE II

pH	H <sub>2</sub> SO <sub>4</sub>		H <sub>3</sub> PO <sub>4</sub>		Tartaric Acid		Citric Acid	
	Used	Used	Calc.	Used	Calc.	Used	Calc.	
4.05	1	1	3	—	—	2	2	
3.86	—	3	—	2	2	—	—	
3.77	—	4	—	—	—	4	4	
3.64	2	—	—	4	4	6	6	
3.54	—	7	—	—	—	8	7	
3.46	—	8	—	6	5.3	10	8	
3.42	3	9	9	—	—	—	—	
3.34	—	10	—	8	6.6	14	10	
3.24	—	12	—	10	8	18	12	
3.18	4	13	12	12	8	20	12	
3.12	—	14	—	14	9.3	26	14	
3.07	5	15	15	16	10	30	15	
2.98	—	—	—	18	—	40	17	
2.92	—	20	—	24	13	—	—	
2.89	6	—	—	26	12	50	18	
2.77	7	25	21	40	14	—	—	
2.65	8	35	24	50	16	—	—	
2.50	10	45	30	—	—	—	—	
2.14	20	—	—	—	—	—	—	

A comparison of the number of cc of different acids experimentally required to give the same pH value to a pectin sol, compared with the number theoretically required by the stoichiometric ratios as claimed for pectin and acids by Tarr.

The failure of the data to hold at higher acidities has been accounted for thus, page 24: "It will be observed that as the hydrogen ion concentration is increased, these relations become even more distant. This is exactly what is to be expected if compounds are formed with pectin and the acids which yield ions that are common to the acids. That is, if it is assumed that the addition of tartaric acid to pectin in solution forms a pectin-tartaric acid compound, it is entirely possible to conceive of such a compound as yielding an ion that is common to the tartaric acid. The effect of an ion that is common to an acid is to decrease the dissociation of the acid to the extent to which the dissociation is affected, depending upon the particular acid involved. It is only intended to present this point here, because it offers a possible explanation of the variations that occur between the theoretical stoichiometric relations and actual relations as determined from these data."

This argument is untenable in view of the facts of Table III. This table is an arrangement of the data of the even columns of Table I and represents changes in pH of water free from pectin, resulting from the addition of the same acid increments.

TABLE III

pH	H <sub>2</sub> SO <sub>4</sub>		H <sub>3</sub> PO <sub>4</sub>		Tartaric Acid		Citric Acid	
	Used	Calo.	Used	Calo.	Used	Calo.	Used	Calo.
3.35	—	—	—	—	—	—	2	—
3.28	—	—	2	—	—	—	—	—
3.14	—	—	3	—	2	2	4	3
3.03	1	—	4	3	—	—	6	4
2.97	—	—	—	—	—	—	8	—
2.92	—	—	5	—	4	3.3	10	5
2.84	—	—	—	—	6	—	14	—
2.81	2	—	6	6	8	4	—	—
2.76	—	—	—	—	—	—	18	—
2.73	—	—	9	—	10	6	22	9
2.68	—	—	11	—	14	—	30	—
2.62	3	—	13	9	18	6	40	9
2.59	—	—	15	—	22	—	—	—
2.54	4	—	—	—	26	—	50	—
2.53	—	—	20	—	30	—	—	—
2.43	6	—	25	18	50	12	—	—
2.32	7	—	40	—	—	—	—	—
2.27	9	—	45	—	—	—	—	—

A comparison of the number of cc of different acids experimentally required to give the same pH value to water, compared with the number of cc which correspond to the stoichiometric ratios claimed for pectin and these acids.

The significant thing about this table in comparison with Table II is that below the horizontal lines, there is the same falling away from an approach to a definite ratio. The "suppression of ionization" by a common ion argument is, therefore, less convincing since, according to these two tables, the same conclusions could be drawn for acid and water as for acid and pectin.

In the case of citric and tartaric acids the stoichiometric ratio fails to hold after 6 cc. of acid have been incorporated in the sol. When pectin is absent (Table III) the ratio fails to be approximated after 4 cc of these two acids have been added.

There seems to be no substantiation of the hypothesis of a pectin-acid compound from these data.

As to the "buffer action" of pectin to which one frequently finds reference in the literature, Tarr says, page 32: "It is evident from the data that the presence of pectin does materially depress the dissociations of the acids."

This impression is certainly to be derived from Table I for in the case of every acid considered, the pH value indicates that the mixture is less acid in the presence of pectin than when pectin is absent.

A careful study of Table I, however, shows that, although the addition of 1 cc of sulphuric acid to water resulted in an increase in acidity represented by 2.44 (5.50-3.06) points as against an increase of only 0.15 (4.21-4.06)

points when pectin was present, *the next added increments*, 19 cc in all, increased the pH value of water only 1.09 (3.06-1.97) points as against 1.92 (4.06-2.14) points when pectin was present. That is to say, after the added acid had disposed of some non-pectin influence in the pectin sol, presumably salt impurities, the presence of pectin instead of "depressing" the dissociation of acid increased the hydrogen ion concentration.

In the case of phosphoric acid it took 7 cc to dispose of the salt influence. The first 7 cc of the added acid caused a pH change of 2.69 in the absence of pectin and 0.63 in the presence of pectin, but the next 38 cc caused an increase in pH of only 0.52 in the absence of pectin and 1.05 when pectin was present.

In the case of tartaric and citric acids the first 2 cc disposed of the salts and in the case of acetic acid it took 20 cc.

Horizontal lines in Table I indicate the acidities for each acid at which the salt impurity influence appears to be overcome. These lines divide each column of data into two groups: (a) The group in which the increase in pH value is greater in the absence of pectin than in its presence and (b) the group in which the increase in pH value is less in the absence of pectin than in its presence. Table IV summarizes the pH values for these two groups.

TABLE IV

Added Acid Increment	Changes in pH Values									
	H <sub>2</sub> SO <sub>4</sub>		H <sub>2</sub> PO <sub>4</sub>		Tartaric Acid		Citric Acid		Acetic Acid	
	H <sub>2</sub> O	Pect.	H <sub>2</sub> O	Pect.	H <sub>2</sub> O	Pect.	H <sub>2</sub> O	Pect.	H <sub>2</sub> O	Pect.
(a) 0-1	2.44	0.15	—	—	—	—	—	—	—	—
(b) 1-20	1.09	1.92	—	—	—	—	—	—	—	—
(a) 0-7	—	—	2.69	0.63	—	—	—	—	—	—
(b) 7-45	—	—	0.52	1.05	—	—	—	—	—	—
(a) 0-2	—	—	—	—	2.37	0.34	2.15	0.12	—	—
(b) 2-50	—	—	—	—	0.70	1.21	0.18	1.15	—	—
(a) 0-20	—	—	—	—	—	—	—	—	2.25	0.56
(b) 20-50	—	—	—	—	—	—	—	—	0.18	0.20

Data calculated from Table I to compare the *change* in pH value of H<sub>2</sub>O and a 1% pectin sol, resulting from the addition of acids (a) up to, and (b) beyond the point where the presence of pectin ceases to cause an abnormal lowering of the pH values of a pectin sol as compared with a pectin free solution.

In this case the *change* in pH value caused by the addition of a given increment of acid was more significant than the actual pH. A consideration of the pH value alone gave the wrong impression as to the properties of pectin for it seems probable that a property was attributed to pectin which belonged to the salt impurities. In this connection it is interesting to note that phosphoric acid, a stronger acid than tartaric or citric, required more than three times as many cc to dispose of the effect of the salt impurities.

If the presence of salt impurities is the correct and the whole explanation of the pH changes just considered, one might expect this change to start at the same pH value in the case of each acid. This is not the case as may be seen by reference to Table I.

With sulphuric acid the change starts at the pH value 4.06; with citric at 4.04; with tartaric at 3.88; with acetic at 3.64, and with phosphoric at 3.54. Furthermore, the pH value in the water solution resulting from the addition of the same increment of acid does not show the same order of variation as is shown by the pectin sols. This is brought out better in Table V.

TABLE V

1	2	3	4
Acid	pH of Pectin Sol	cc acid per 100 cc. Solu.	pH of water Solu.
H <sub>2</sub> SO <sub>4</sub>	4.06(5)	1.0	3.06(2)
Citric	4.04(4)	2.0	3.35(5)
Tartaric	3.88(3)	2.0	3.13(3)
Acetic	3.64(2)	20.0	3.25(4)
Phosphoric	3.54(1)	7.0	2.81(1)

Data transferred from Table I:

The pH of pectin sol (column 2) at which the effect of the salt impurities of the 1% pectin sol are overcome by the acid designated in column 3. In the last column (4) the pH value of water acidified by the same number of cc of acid is indicated.

The difference in the order of the acids, placed according to their pH values, in the absence and in the presence of pectin must be explained.

Since pectin increased the hydrogen ion concentration of the sol after the salt impurities were neutralized, it must have been functioning similarly during the neutralization of the salts. We know from cataphoresis experiments that pectin adsorbs anions preferentially and we believe that this is responsible for the characteristic acidity of pectin sols, since such a preferential adsorption would always leave a predominance of hydrogen ions in the dispersing medium.

From this standpoint it is interesting to note that 1 cc of H<sub>2</sub>SO<sub>4</sub> gives a greater acidity increase to water than does 2 cc of either citric or tartaric, as would be expected even in the presence of salts; but, when pectin is present, the order is reversed, and the organic acids give a greater increase in pH to the pectin sol containing salt than does the inorganic acid.

This observation can be explained by the assumption that pectin shows a greater preferential adsorption for organic anions than for the sulphate ion and so increases the hydrogen ion available for neutralizing the salt impurities, in the case of the organic acids.

If the pectin had not thus functioned to increase the hydrogen ion concentration more of the organic acids would have been necessary to overcome the salt effect; so the order of the pH would have been the same as for water. For example, if 4 cc. of tartaric acid had been used in Table V, Column 3, instead of 2 cc., this amount of acid added to water would have changed

the pH value in Column 4 to 2.93, making the order in that column the same as in Column 2 for tartaric and sulphuric acids.

It seems then that anion adsorption by pectin has played a definite part in the establishing of the pH values of Table I.

If the stoichiometric relation as it exists at the beginning of each series in Table II is attributable entirely to the salt impurities, this relation should cease to hold at the same pH that the buffer effect of the salts is overcome. This is not exactly the case as is shown in Table VI.

TABLE VI

Acids	<sup>1</sup> pH values taken from Table II	<sup>2</sup> pH values taken from Table V	<sup>3</sup> Differences (Col. 2-Col. 1)
Sulphuric	—	4.06	—
Phosphoric	3.07	3.54	0.47
Tartaric	3.46	3.88	0.42
Citric	3.64	4.04	0.40

A comparison of the pH values at which the stoichiometric relations fail to hold, as per the horizontal divisions of Table II, and the pH values at which the buffer salt effect is overcome, as per Table V, Column 2.

The difference between these two pH values for each acid may be considered as constant, since the experimental determination of pH values for the same pectin sol to which no acid had been added (Table I) varied between 4.22 and 4.16, that is, by 0.06 points. This may mean that at the pH values, as of Table V, at which the buffer salt action is overcome, the salts are all in such a form that they no longer act as buffers to the particular acid, but that they are not completely neutralized until the pH values, as shown by the values from Table II, are realized.

#### Conclusions

1. There is no substantiation for the hypothesis of a pectin-acid compound either on the basis of "optimum acidity" in jelly formation in the presence of sugar, or a stoichiometric relation between acids in their relation to pectin the absence of sugar.
2. Pectin does not reduce the hydrogen ion concentration of an acid solution. On the other hand it increases the hydrogen ion concentration of the mixtures as a result of preferential anion adsorption.
3. The ignored presence of salt impurities together with a consideration of the actual pH value, rather than the change in pH value, resulting from the addition of a given increment of acid, is responsible for the mistaken impression that pectin has a "buffer" action tending to suppress acid ionization.

*Cornell University*

13-50

## A MODIFIED VACUUM-WALLED ADIABATIC CALORIMETER\*

BY B. CLIFFORD HENDRICKS, JAMES H. DORSEY, ROYCE LEROY,  
AND A. G. MOSELEY JR.

In the course of some investigations carried on in this laboratory upon the oxidation of sugars in alkali media<sup>1,2</sup> it became desirable to know something of the thermal effects accompanying these reactions. A survey of the literature of sugar oxidation gave no data applicable to the studies under way.

In order to determine the values needed an apparatus was developed from the investigations of others<sup>3,4,5</sup> that would yield the information desired. The outcome is a calorimeter of a precision of approximately five per mille and of the simple assembly described.

### Apparatus

The calorimeter consisted of a cylindrical silvered Dewar tube (B, Fig. 1) of 334 mm. depth and 72 mm. inside diameter and of slightly more than 1300 cc. capacity. This flask was fitted with a rubber<sup>6</sup> stopper<sup>6A</sup> (F) 40 mm. thick through which passed the connecting rod of the vertical reciprocating stirring apparatus (G), the thermometer (J) and a glass rod (E) (or the heating unit for specific heat determinations) for opening the dilution cup (D) which is suspended in the tube by means of nickel wires fastened to the stopper. The calorimeter vessel is submerged in a water bath contained in a wooden keg (A) of about eighty liters capacity supplied with a propeller type copper stirrer, (L), a heating bulb, (M), an overflow pipe, (N), and a cold water tap (O). A second Beckmann thermometer (K) is suspended in this outer bath.

Above this water bath a temperature control closet was constructed of wall board. In this closet the temperature was maintained within a few tenths of a degree of that of the calorimeter jacket by the aid of a simple electric heating arrangement. Previous tests had revealed that a difference of one degree between jacket temperature and air temperature gave no measurable effect upon the calorimeter temperature unless the experiment ran

\* Contribution from the Chemical Laboratory of the University of Nebraska.

<sup>1</sup> Fred W. Jensen and Fred W. Upson: *J. Am. Chem. Soc.*, **47**, 3019 (1925).

<sup>2</sup> M. H. Power and Fred W. Upson: *J. Am. Chem. Soc.*, **48**, 195 (1926).

<sup>3</sup> D. A. MacInnes and J. M. Braham: *J. Am. Chem. Soc.*, **39**, 2110 (1917).

<sup>4</sup> Frederick Barry: *J. Am. Chem. Soc.*, **42**, 1911 (1920).

<sup>5</sup> F. Russell Bichowsky: *J. Am. Chem. Soc.*, **45**, 2225 (1923).

<sup>6</sup> Bureau Standards Bulletin 11, 198 (1925).

<sup>6A</sup> While this rubber would, according to Dickinson, produce an appreciable lag for its share of the calorimeter surface, the fact that it is less than 5% of the total surface and that the thermal head was never as much as .03°C. renders its influence negligible in the work here described.

for more than one hour. Since all tests here reported are under one hour in duration this control was considered adequate.

The calorimeter thermometer (J) is a Beckmann type mercury thermometer similar to the instruments used by Barry.<sup>7</sup> It was calibrated by the U. S. Bureau of Standards (B. S. No. 35605). The range of its scale is

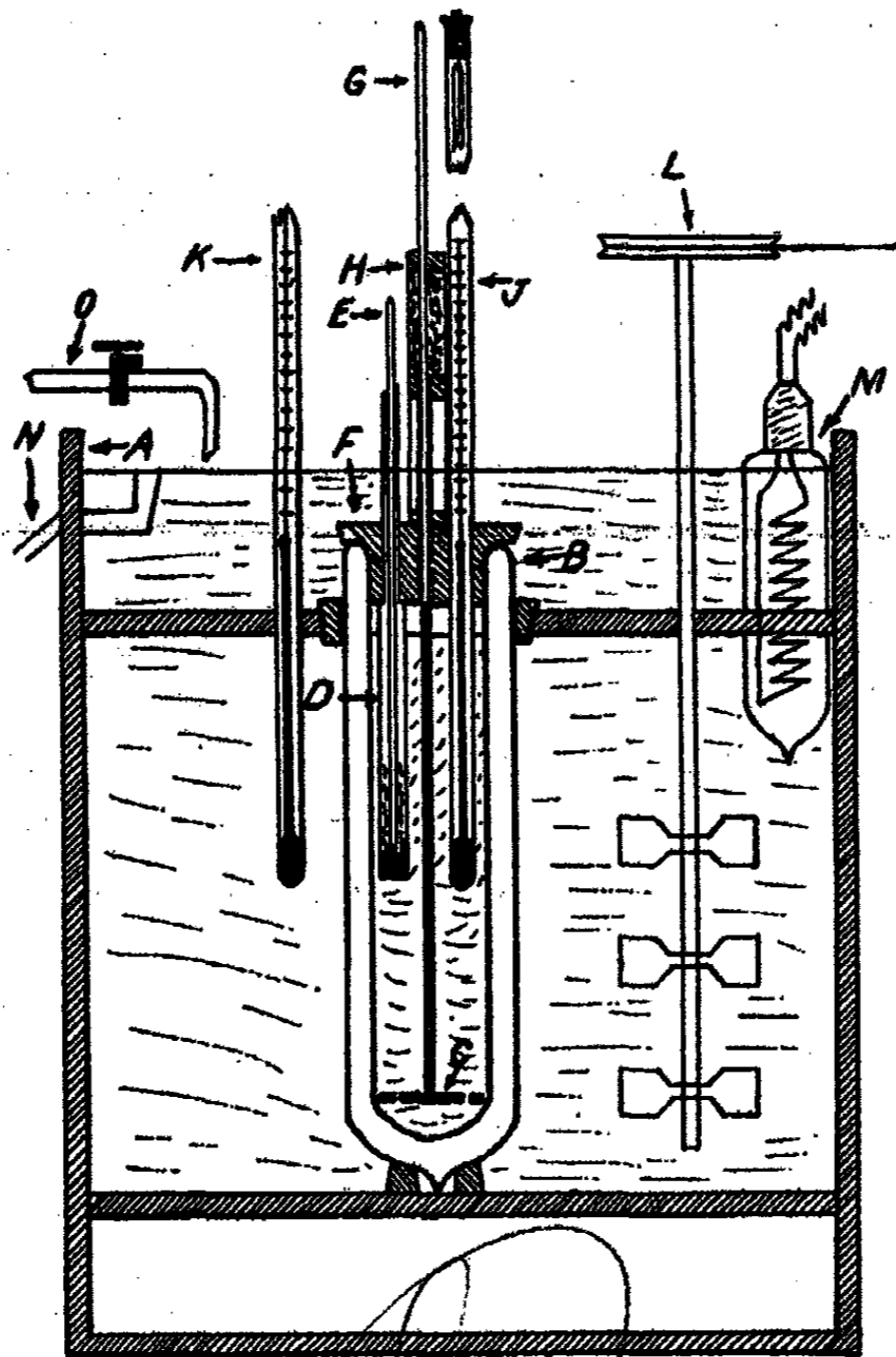

FIG. 1

three degrees over a length of twenty-one centimeters making the smallest division (.005°C.) about .035 cm. By the aid of a reading lens readings to .0005°C. were possible of estimate. This thermometer was set with its zero closely equivalent to 20°C.

The thermometer (K) used in water bath or jacket is also a Beckmann. Its range was five degrees with its smallest division one hundredth of a degree centigrade. This instrument was standardized against the calorimeter thermometer.

Tests showed that a difference of but five hundredths of a degree between calorimeter and jacket temperature required an hour to bring a rise or fall

<sup>7</sup> Ref. 4, page 1918.

of  $.002^{\circ}$  in the calorimeter's temperature. In the work reported in the following pages at no time was the thermal head more than  $.02^{\circ}$ .

The calorimeter stirrer (C) consists of a nickel-plated copper disk perforated by ten holes. Its nickel-plated copper rod is sealed into a glass tube (G) which passes thru another glass tube and chimney (H) packed with cotton wool. This stirrer was driven by an induction motor equipped with a heavy reducing gear. It ran the stirrer at a very constant speed of twenty strokes per minute. This rate gave a satisfactory agitation for the rapid solution, in the heats of solution experiments, yet produced no detectable heat of stirring. The jacket stirrer was driven by a separate motor and at a much higher rate than that for the calorimeter. This higher speed was found especially necessary to prevent inequalities when either heat or cold water was added (at O) in maintaining adiabatic conditions.

The dilution cup (D) consisted of a pyrex test tube blown out at one end, fitted with a glass stopper ground into it. It was opened by the glass rod (E) which passed thru a glass chimney passing thru the calorimeter stopper. Cotton wool was packed around the rod in the upper part of the chimney to prevent air circulation and loss of heat from the calorimeter by the escape of water vapor. The cup's ground-glass stopper swung back against the side of the calorimeter on a nickel wire support when pushed out, so as not to interfere with stirring.

#### The Water Equivalent of the Calorimeter

In determining the heat capacity of the calorimeter, as well as in specific heat determinations for sodium hydroxide, an electrical "set-up", identical with that diagrammed<sup>8</sup> by MacInnes and Braham, was used. In the work under discussion the heavy leads to and from the heating unit were assumed to have negligible resistance so the current was calculated from the potential drop measured and the accurately known resistance between the points of measured potential difference. The heating unit, a compact coil of 125 cm. of number 30 platinum wire, was enclosed in a pyrex glass tube and, as previously stated, was provided with heavy number ten copper leads. Its resistance was measured under the same temperature conditions as when in use and found to be  $4.807 \pm .001$  ohms. The resistance "in series with the heater" measured  $1.004 \pm .001$  ohms.

In the "heat capacity" measurements the heating unit was inserted thru the opening in the calorimeter stopper, filled in figure one by rod (E) and its chimney. The heating unit and the glass which it replaced were of equivalent weight and were treated as of equal heat capacities. The heating unit was so placed that its coils were well below the calorimeter's water surface.

The assemblies of apparatus for heat capacity, specific heat, and heat of solution determinations were the same. This assembly involved the following:

The water for heat capacity and heat of solution experiments was weighed in a calibrated volumetric flask. One thousand grams were used unless otherwise stated, the weight having been made for delivery. The water sample



was always brought to an approximate temperature of  $21^{\circ}$  by the proper treatment before delivery into the calorimeter vessel.

The calorimeter stopper, coated previously with melted paraffin to serve as a seal, and containing the heating unit, was placed in position after the water was introduced into the vessel. The calorimeter thus assembled and loaded was wedged into place in the "jacket water-bath". The stirrers were started and the temperature of calorimeter, jacket, and air closet were regulated until equilibrium was attained. As soon as an equilibrium, such as persisted for a period of twenty to thirty minutes, was reached, the switch throwing the current thru, what might be called, the stabilizing resistance, was thrown and potentiometer readings taken until the battery was sufficiently polarized to give a steady current. When this condition was realized

TABLE I

Water equivalent of calorimeter and accessories.

Weight of water used in each experiment was 1,000 grams and the "series resistance" was 1.004 ohms thruout the experiments.

Exp. No.	Temperature			Corrected Time		Voltage across series resistance	Current I	Water Equiv.
	Initial (ti)	Final (tf)	Change (tf-ti)	Change $\Delta t$	Seconds t'			
1.	21.5500	21.7270	.1770	.1798	900	.4355	.4338	84.0
2.	21.2150	21.3930	.1780	.1780	900	.4333	.4316	83.9
3.	21.3000	21.4740	.1740	.1740	900	.4287	.4270	84.4
4.	21.1645	21.3950	.2305	.2305	1200	.4270	.4253	83.8
5.	21.0500	21.2750	.2250	.2250	1200	.4220	.4203	84.5
6.	21.2750	21.4975	.2225	.2225	1200	.4196	.4179	84.2

The average water equivalent = 84.1

careful record was made, both of the calorimeter temperature and the time at which the switch was thrown putting the current thru the heating unit. This time was measured by the use of a stop watch.

The temperature and potentiometer reading were repeated each five or fewer minutes, during the period of heating, especial care being taken to keep jacket and air closet temperatures in agreement with that of the calorimeter. At the end of the planned time-interval the switch was opened and the observations of temperature of the calorimeter continued, as adjustments of jacket and air closet temperature were made, until four or five successive calorimeter temperature readings were in agreement. The total temperature rise was corrected by the Bureau of Standards calibration chart and the average of the five or more potentiometer readings was taken as the correct value. Using 4.1818 as the mechanical equivalent<sup>8</sup> and the specific heat of water at  $21^{\circ}\text{C}$ . as .9983 calories per gram<sup>9</sup> the water equivalent of the calorimeter and its accessories was calculated by the formulation: water equivalent

<sup>8</sup> "International Critical Tables," 5, 78.

<sup>9</sup> Landolt-Börnstein: "Physikalisch-Chemische Tabellen, II, 1250.

=  $(I^2Rt'/4.1818 \Delta t)$  minus the heat capacity of water in the calorimeter. In this equation the current thru the heating unit is represented by  $I$ , heating unit resistance (4.807 ohms) by  $R$ , the period of heating by  $t'$  and the increase of calorimeter temperature by  $\Delta t$ .

Maximum deviation from average .4 or 0.5%. A deviation of the temperature reading on experiment number five by minus 0.0001° would change its resulting water equivalent to 85.0 or .9 units more than the average.

The deviation of .4 in capacity amounts to but .004% of the total capacity of the calorimeter when containing 1000 grams of water.

#### Specific Heats of Sodium Hydroxide Solutions

Since sodium hydroxide is used in many sugar oxidations, it was chosen to test the performance of the calorimeter. The specific heats of sodium hydroxide solutions at two concentrations were determined. The procedure in these determinations was essentially the same as that in determining the heat capacity of the calorimeter except the solution of the alkali was introduced into the calorimeter instead of the usual charge of water. The weight of solution was so selected as to make the volume in each case about one liter.

#### Preparation of Solutions

Sodium hydroxide solution was made up from Merck's blue label stick sodium hydroxide. The six normal dilution was made by using slightly more than the calculated amount of solid solute. To this, water was added until the desired concentration was attained. The solution's concentration was checked by titration against standard sulphuric acid solution. The prepared solution was preserved in a large glass bottle fitted with a siphon and protecting tube of soda-lime. The three normal sodium hydroxide solution was prepared by diluting the six normal solution with an equal volume of water.

#### Calculation of Specific Heat

In determining the specific heat of the solution the following relationship was used: Specific heat =  $\frac{I}{W\Delta t} \left( \frac{I^2Rt'}{4.1818} - H\Delta t \right)$  in which  $W$  is the weight of the solution in grams,  $\Delta t$  is the temperature change,  $I$  is the current thru the heating unit,  $R$  is the resistance (4.807 ohms) of the heating unit,  $t'$  is the time duration of the experiment and  $H$  is the water equivalent of the calorimeter. The current was found by calculation from ohms law;  $I = E/R$  in which  $E$  is the "series-resistance" potential drop and  $R$  is that resistance (1.004 ohms).

Table II presents the results for five experiments with six normal sodium hydroxide. The columns contain in order: initial,  $t_i$ ; final,  $t_f$ ; apparent change,  $t$ ; and corrected change,  $\Delta t$ , of temperature;  $t'$ , time duration (in seconds) of the experiment;  $V$ , potential drop across the "series resistance,"  $I$ , the current; and Sp. H, the specific heat. Resistance of the heating unit for the first three experiments was 4.713 ohms but for the last two it was 4.807 ohms.

TABLE II

## Specific heat of 6N NaOH

The weight of solution taken in each experiment was 1200 grams.

No.	$t_i$	$t_f$	$t$	$\Delta t$	$t'$	V	I	Sp.H
1.	21.1750	21.3950	.2200	.2200	3000	.2687	.2676	.8470
2.	21.1700	21.3850	.2150	.2150	3000	.2641	.2631	.8364
3.	21.2875	21.4975	.2100	.2100	3000	.2635	.2625	.8537
4.	21.0345	21.3810	.3465	.3465	1500	.4705	.4686	.8404
5.	21.3810	21.7200	.3390	.3390	1500	.4699	.4680	.8499

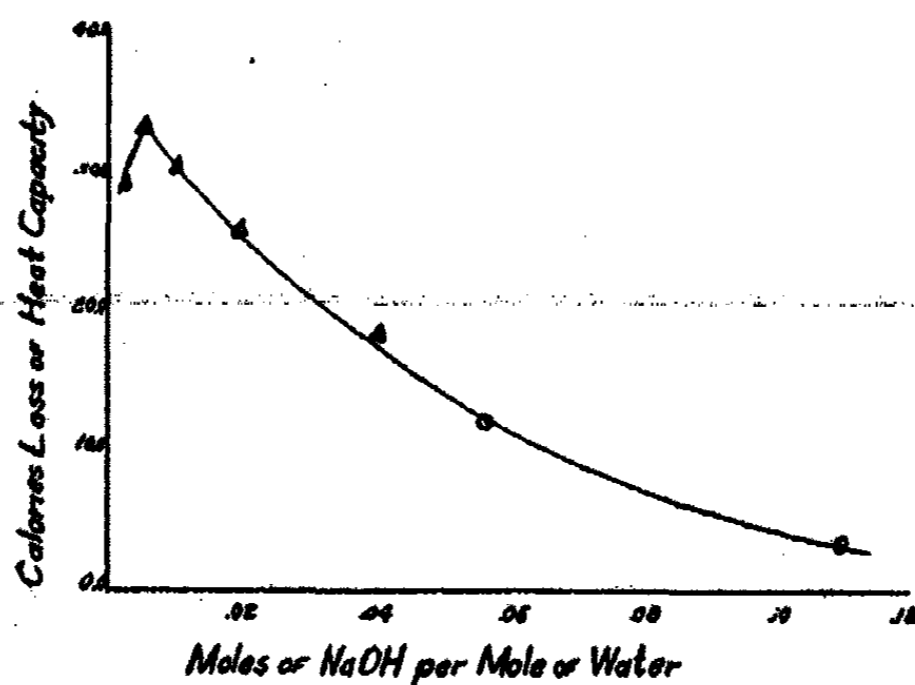

FIG. 2

At temperatures of 21.5°C 6N NaOH has an average Sp.H. of .8455. The maximum deviation from this is .0091. This deviation is 1.1%. It would require a temperature error of .0020°C to equal this deviation.

In Table III are given results for five experiments with three normal sodium hydroxide.

TABLE III

## Specific heat of 3 N NaOH

Weight of solution used in each experiment was 1100 grams. Resistance of the heating unit was 4.807 ohms.

No.	$t_i$	$t_f$	$t$	$\Delta t$	$t'$	V	I	Sp.H
1.	21.1450	21.4895	0.3445	0.3445	1500	.4638	.4620	.8942
2.	21.4895	21.8300	0.3405	0.3455	1500	.4633	.4615	.8896
3.	21.1100	21.4530	0.3430	0.3430	1500	.4627	.4609	.8938
4.	21.4500	21.7900	0.3400	0.3440	1500	.4609	.4591	.8836
5.	21.7450	22.0810	0.3360	0.3380	1500	.4596	.4578	.8952

At temperature of 21.7°C. the 3N NaOH has an average specific heat of .8913.

The maximum deviation from this is .0077. This deviation is 0.94%. It would require a temperature error of .0016°C. to produce this deviation.

Richards and Rowe<sup>9</sup> have previously found the specific heats of sodium hydroxide solutions but for different concentrations than those above. The above values have been recalculated from the form 6N to NaOH·8.96 H<sub>2</sub>O and from 3N to NaOH·18.2 H<sub>2</sub>O. The loss of heat capacity is calculated as suggested by Richards and Rowe.<sup>10</sup> By assuming Kopp's law that the heat capacity of a compound is the sum of its atomic heats; NaOH has a heat capacity of 6.4 + 2.3 + 4.0 or 12.7. Using this, the loss in heat capacity, for each dilution, is determined and the result shown in: \_\_\_\_\_

TABLE IV

## Loss of heat capacity

Source of Data	Moles of NaOH per Mole H <sub>2</sub> O	Specific Heat	Temperature	Loss of Capacity
Richards and Rowe <sup>11</sup>	.0025	.9907	19.8°C.	29.7
	.005	.9818	19.8°C.	33.7
	.01	.9670	19.7°C.	30.7
	.02	.9418	20.7°C.	26.1
	.04	.9046	19.8°C.	18.7
Hendricks and others	.0548	.8913	21.7°C.	12.1
	.1114	.8455	21.5°C.	3.6

When the data from table four is represented graphically, figure two results. The authors take it that the alignment of the two values in the curve which their work has contributed indicates that this calorimeter can yield values that are creditably concordant with the work of others. The helpfulness of this curve in practical work is well set forth in the paper of Richards and Rowe.<sup>12</sup>

## Heats of Solution of Sugars

As a further check upon the calorimeter's accomplishments, a series of experiments was performed upon the heats of solution for anhydrous alpha-glucose and anhydrous sucrose.

The procedure in determining these heats of solution was much as that previously described. One change, necessary in these tests, placed the dilution cup where the heating unit had been before. The sugar sample was weighed into this cup and, after temperature equilibrium had been attained, the sample was introduced from this dilution cup into the solute.

## Preparation of Sugars

The alpha-glucose was prepared from Mallinckrodt's C. P. grade anhydrous dextrose, using the method of Hudson and Dale<sup>13</sup>. The crystals were dried at 105°C. and kept in a desiccator over conc. H<sub>2</sub>SO<sub>4</sub> until needed.

<sup>9</sup> Richards and Rowe: J. Am. Chem. Soc., 43, 770-790 (1921).

<sup>10</sup> Ref. 9, page 790.

<sup>11</sup> Ref. 9, pages 781-782.

<sup>12</sup> Ref. 9 page 791.

<sup>13</sup> Hudson and Dale: J. Am. Chem. Soc., 39, 320 (1917).

The sucrose used was recrystallized Merck's C. P. grade saccharose. The recrystallization was carried out by addition of absolute alcohol to the saturated solution.

Barry<sup>14</sup> has previously determined these values at temperatures and dilution near enough the work here reported to make comparisons permissible.

Table V presents the data from five experiments with anhydrous alpha-glucose and Table VI similar data from experiments on anhydrous sucrose.

TABLE V  
Heat of solution of anhydrous alpha glucose.  
Total water-equivalent of the system in each case 1082.7

Sample No.	Weight	ti	Temperatures tf	(ti-tf)	Δt	Heat of Solution*
1.	2.7528	21.5530	21.5210	0.0320	0.0330	-12.98
2.	2.9930	21.8125	21.7760	0.0365	0.0375	-13.56
3.	3.1181	21.5820	21.5420	0.0400	0.0420	-14.58
4.	2.8248	21.4650	21.4280	0.0370	0.0370	-14.18
5.	2.7798	21.8140	21.7810	0.0330	0.0345	-13.97

Average at 21.6°C. calories per gram solute, -13.85

Maximum deviation from average .87 or 6.3%

Corresponding temperature error .0008°C.

Barry<sup>15</sup> found the heat of solution for alpha-glucose at 19.6°C. to be -13.96, a value which deviates from the above value by but 0.8%.

\* The heat of solution is here taken to be the heat absorbed per gram of solute per liter of solvent.

TABLE VI  
Heat of solution of anhydrous sucrose. Total water-equivalent of the system in each case 1082.7.

Sample No.	Weight	ti	Temperatures tf	Δt	Heat of Solution
1.	4.4019	21.8620	21.8475	0.0145	-3.56
2.	4.8817	22.0150	21.9985	0.0165	-3.65
3.	4.1316	21.9020	21.8890	0.0130	-3.41
4.	4.9988	21.6715	21.6565	0.0150	-3.25
5.	4.5500	21.6600	21.6450	0.0150	-3.57

Average at 21.8°C. in calories per gram of solute is -3.49. Maximum deviation from average .24 or 6.9%. Corresponding temperature error .0002°.

Barry<sup>16</sup> obtained the value -3.43 for the heat of solution for sucrose at a temperature of 19.8°. This, it will be noted, is but 1.7% different from the value above.

<sup>14</sup> Barry: J. Am. Chem. Soc., 42, 1927-1928 (1920).

<sup>15</sup> Ref. 4, page 1928.

<sup>16</sup> Ref. 4, p. 1927

### Conclusion

A calorimeter has been described which has the advantages of being:

1) Easy of assembly; 2) Direct in reading by reason of the use of mercury in glass thermometers; 3) Usably adiabatic without the usual tediousness of such manipulation. This feature of the apparatus is largely due to the use of the vacuum-walled Dewar as a calorimeter vessel. 4) Relatively inexpensive for first cost.

The performance of this calorimeter has been shown.

Specific heat constants found by its use for sodium hydroxide solutions of higher concentrations than any results now available fall into alignment when plotted with data for more dilute solutions. The heat of solution found for anhydrous sucrose which deviates but 1.7% from the most acceptable published value. This value, however, was from a series which showed a maximum deviation of .87% from the average. Similarly this apparatus has yielded a heat of solution for alpha glucose which deviates from the best published results by 0.8% while those same results deviate from each other by 1.1%.

## VELOCITY OF A BIMOLECULAR REACTION IN A HOMOGENEOUS SYSTEM

BY SAMUEL C. HORNING

The following derivation is an attempt to derive the equation for the velocity of a reaction from the simplest possible assumptions. The reaction  $A + B = C + D$  is accompanied by the free energy change  $-\Delta F$ . This reaction will be caused by a collision between the molecules of A which are in a state  $x$  and the molecules of B which are in a state  $y$ . For the reverse reaction, the molecules of C must be in the state  $x'$  and the molecules of D in the state  $y'$ . The free energies of the reacting states will then be  $F_x + F_y$  and  $F_{x'} + F_{y'}$ , and the free energy of formation of these states will be  $\Delta F_x + \Delta F_y$  and  $\Delta F_{x'} + \Delta F_{y'}$ . It can easily be seen that,  $F_x + F_y = F_{x'} + F_{y'}$

$$\text{and} \quad -\Delta F_{x'} - \Delta F_{y'} + \Delta F_x + \Delta F_y = -\Delta F$$

The free energy in the state  $A + B$  must be increased to that in the state  $x, y$  in order that the reaction  $x, y$  to  $C + D$  may occur. Similarly, the state  $C + D$  must change to  $x', y'$  for the reaction  $x', y'$  to  $A + B$ . If the direction of the reaction  $x', y'$  to  $A + B$  is reversed, then at some point  $x'', y''$  the free energy will equal that in the state  $x, y$ . The reactions  $x', y'$  to  $x'', y''$  and  $x, y$  to  $x', y'$  or its equal  $x'', y''$  to  $x', y'$  occur spontaneously. For this to be true,  $x, y$ ;  $x', y'$ ; and  $x'', y''$  must coincide.

The rate of reaction may be expressed as  $dx_0/dt = K_1 (A - x_0) (B - x_0)$ . This will equal the number of molecules in state  $x, y$  which collide. The number of molecular collisions between these two unlike molecules<sup>1</sup> is  $Z = 2N_x N_y \sigma_{xy}^2 \sqrt{2\pi kT (M_a + M_b) / (M_a M_b)}$ . From the Boltzmann distribution law;

$$\frac{N_x}{N_a} = e^{\frac{-\Delta F_x}{RT}}$$

and

$$\frac{N_y}{N_b} = e^{\frac{-\Delta F_y}{RT}}$$

The rate of reaction given by the two expressions can be equated.

$$K_1 (A - x_0) (B - x_0) = 2 N_a N_b \sigma_{xy}^2 e^{\frac{-\Delta F_x - \Delta F_y}{RT}} \sqrt{2\pi kT (M_a + M_b) / (M_a M_b)}$$

By inspection, it will be seen that  $(A - x_0) (B - x_0)$  which represents the activity product of the reacting substances is equal to:

$$N_a N_b \sigma_{xy}^2 \sqrt{M_a + M_b / M_a M_b}$$

<sup>1</sup> Tolman: "Statistical Mechanics," 242.

The activity of a substance depends, therefore, upon the size and weight of the reacting molecules. A similar equation will hold for the reverse reaction.

$$K_2(C)(D) = 2 N_0 N_0 e^{\frac{-\Delta F_x' - \Delta F_y'}{RT}} \sigma_{x',y'}^2 \sqrt{2 \pi KT (M_c + M_d) / (M_c M_d)}$$

The equilibrium constant is K

$$K = \frac{K_1}{K_2} = \frac{2 \sqrt{2 \pi KT} e^{\frac{-\Delta F_x - \Delta F_y}{RT}}}{2 \sqrt{2 \pi KT} e^{\frac{-\Delta F_x' - \Delta F_y'}{RT}}} = e^{\frac{-\Delta F}{RT}}$$

Since

$$-\Delta F_x - \Delta F_y + \Delta F_x' + \Delta F_y' = -\Delta F$$

Also

$$K_1 = 2 \sqrt{2 \pi KT} e^{\frac{-\Delta F_x - \Delta F_y}{RT}}$$

And

$$\ln K_1 = \ln 2 \sqrt{2 \pi K} + \ln \sqrt{T} + \frac{-\Delta F_x - \Delta F_y}{RT}$$

Or

$$\frac{d \ln K_1}{dT} = \frac{\Delta F_x + \Delta F_y}{RT^2} + \frac{1}{2T}$$



39A-35

429

## THE PURIFICATION AND ESTIMATION OF PECTIN

BY GENE SPENCER

### Ash Composition of Apple Pectin

The spectrogram of apple pectin ash with which we worked gave the lines of the following elements: Na, K, Ca, Mg, Fe, Al, Mn, Si, and P. Chemical analysis shows the presence of chlorides, sulphates, carbonates and organic acid anions. According to Wiley, 56% of the ash of apples, expressed as oxides, is potassium, 9% is phosphorus; Mg, Ca, S, are each present in the neighborhood of 3%; the other elements are present in quantities less than one per cent.

There are three recognized methods for removing electrolyte impurities from colloid sols: electro dialysis; reprecipitation; washing by decantation with a non-peptizing solvent.

### Methods of Purification

*Reprecipitation by Alcohol:* Taking ash content as criterion of efficiency, reprecipitation by alcohol is, in our opinion, the least satisfactory of the three methods. It involves the handling of large volumes of filtrate to obtain a relatively small yield of purified pectin, and there is an unavoidable loss of pectin in the filtrate. The recovery of this pectin may be accomplished by filtrate concentration followed by alcohol treatment. If heat is used in evaporation of the filtrate, there is an appreciable loss of pectin by hydrolysis as may be shown by the jelly-forming power of the product. This recovery does not seem to be worth while on a laboratory scale, at least.

The best results by this reprecipitation method are obtained if the following facts are recognized:

1. Experimentally the more jelly-like a precipitate, the larger is the amount of ash retained. This, theoretically, is due to the greater surface exposed for salt adsorption and to a greater occlusion and adsorption of mother liquor. A more granular, compact, and easily filterable precipitate was obtained by adding the alcohol to the pectin rather than in the reverse order.

2. The removal of mother liquor by pressure filtration is experimentally equivalent to several reprecipitations, as is shown by the ash reduction. Removal of mother liquor by centrifuge is not sufficient since the pectin retains many times its weight of liquor. Even after pressing the pectin between adsorbent materials until it crumbles, the loss in weight by air drying may be more than the weight of the pectin. Obviously the inorganic substances held by the retained liquor will increase the ash content of the purified material.

3. Precipitation must be immediately followed by filtration. It was found that if the precipitate were allowed to stand in the mother liquor,

or the mother liquor permitted to evaporate from the filtered pectin, instead of carrying the process through as quickly as possible, the ash content was appreciably greater. The smaller the bulk of the pectin precipitate in a given operation the greater the efficiency of purification.

The manipulation and proportions giving the simplest technique and most acceptable results are: 500 cc. of a 2% pectin sol, in a 2-liter separatory funnel, are treated with 600 cc. of 95% alcohol, acidified by 2.5 cc. concentrated hydrochloric acid. The alcohol is added in 100 cc. increments and the funnel shaken vigorously after each addition. The final mix then contains approximately 1% pectin, 50% alcohol and .25% hydrochloric acid, the remainder being water.

The precipitate is emptied directly into a carefully washed and dried canton flannel filter cloth, supported on a hollow square rack. The pectin is pressed with a porcelain spatula until the filtrate comes slowly. The filter cloth is then removed from the rack and folded over the pectin to form a complete envelope container. This pack is subjected to pressure filtration until the liquor comes away dropwise. The filter cake is transferred to a clean dry cloth, broken up and again wrapped and pressed in the filter press between blotting paper or cotton until no further liquor can be pressed out.

Before this filter cake material is reprecipitated preparatory to the next precipitation, it should be crumbled and air-dried; otherwise peptization is never satisfactory, due to the adsorbed alcohol. If this precaution is not taken, the next addition of alcohol gives the jelly-like precipitate which is to be avoided.

The proportions suggested in this method were arrived at by carrying through a series of purifications in which the concentration of the constituents, pectin, acid, alcohol, was varied regularly. Percent ash in the purified pectin, after one precipitation, was plotted against the percent of the variable, in the final mixture. Purification, of course, increased with decreasing pectin; a lowering of pectin below 1% in the final mix was considered impracticable, because of the work involved in obtaining a small amount of pectin and also because of high percent loss in the filtrate. The lower the percent of pectin used the higher our percentage loss of pectin.

In the second series, the curve for per cent ash against per cent acidity began to flatten at approximately 0.3% hydrochloric acid.

In the third series, the ash against per cent alcohol curve began to flatten between 50% and 60%.

As to the number of reprecipitations: A series of experiments was carried out using the manipulation and proportions indicated. The per cent ash plotted against the number of precipitations gave a curve which began to flatten between the third and fourth reprecipitation. The first precipitation removed about 50% of the ash. With each subsequent precipitation the efficiency of purification was definitely lessened, as was to be expected.

*Electro-dialysis:* Electro-dialysis is a satisfactory method for purification but should, in our opinion, be used as a supplement to purification by decan-

tation. When one attempts to electro-dialyze a high-ash pectin, the apparatus needs careful supervision to keep the temperature down.

An apparatus, which ran continuously with practically no attention save for the refilling of the water reservoirs is shown in Fig. 1. The heat produced in the purification of a 2% ash pectin, is removed by the cooled air which stirs the sol, and by a constant dropwise flow of wash-water through the electrode chambers. In the apparatus used this amounts to approximately 1 liter of water per hour over each electrode.

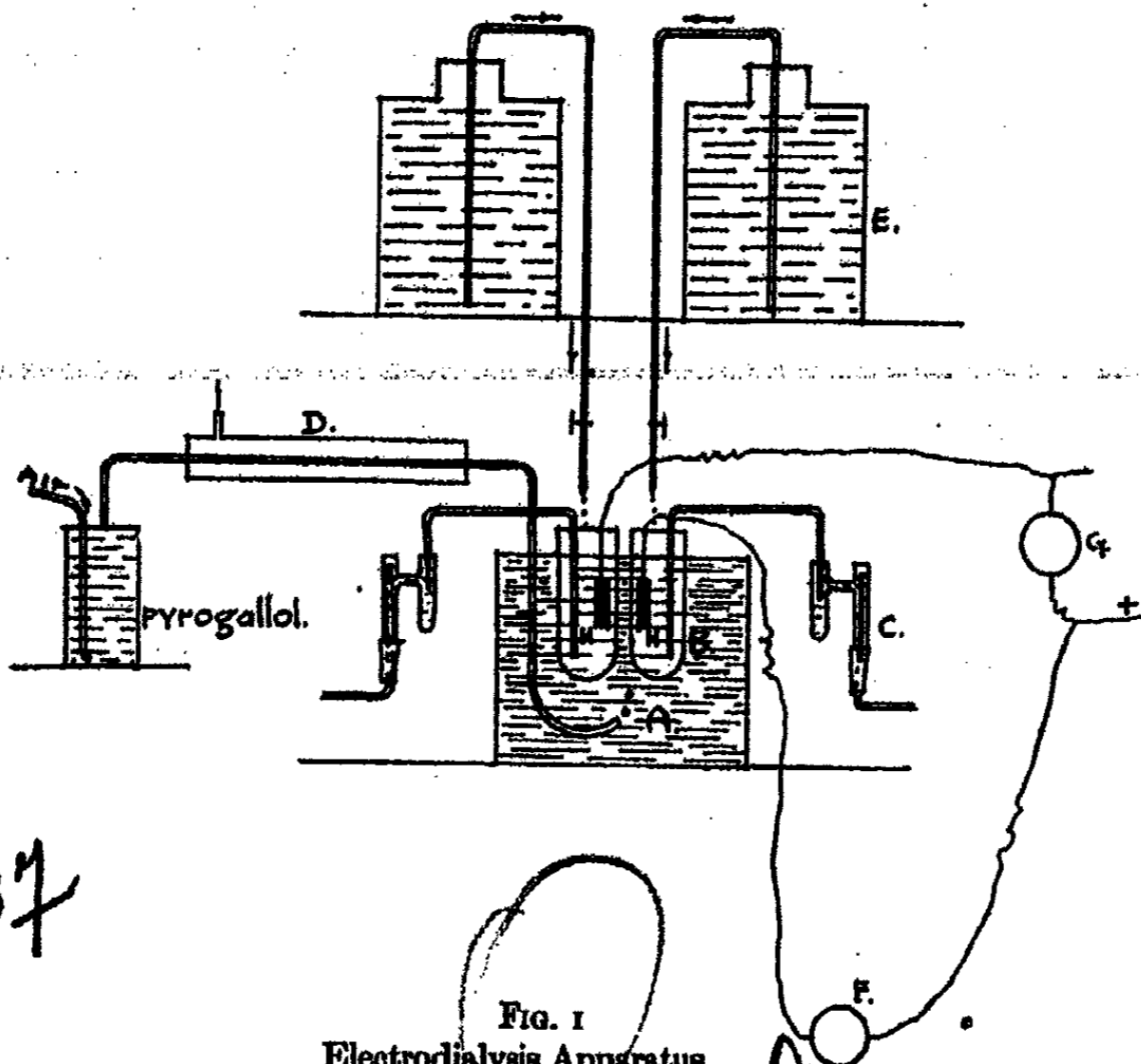

FIG. 1  
Electrodialysis Apparatus

- A. Pectin solution.
- B. Electrode Chamber, made of fat extraction thimbles impregnated with collodion.
- C. Siphon and constant level control traps for electrode chamber.
- D. Liebig condenser for cooling oxygen free air.
- E. Reservoir supplying wash water to the electrode chamber.
- F. Ammeter. G. Voltmeter. H. Platinum Electrodes.

Since pectin is negatively charged, there will be a tendency for it to pass into the anode chamber and for water to pass into the cathode chamber. For this reason water builds up faster in the cathode chamber and there is concomitantly some loss of pectin by cataphoresis, though in general pectin accumulates on the outside of the anode chamber and does not get through the membrane. This pectin layer must be removed occasionally from the outside of the anode chamber, since the air stirring does not take care of it entirely. That there is some loss of pectin by cataphoresis is shown by evaporation and alcohol precipitation of the anode liquor. The cathode liquor gave no evidence of pectin.

The electrode chambers may be made either of animal membrane or collodion. If collodion is used, greater permanence is obtained if fat extraction thimbles are carefully washed and dried, and then impregnated with 3%

nitro-cellulose sol in 25 parts of alcohol and 75 parts of ether. Satisfactory membranes were obtained by immersing the dry thimbles in this collodion sol twice without intermediate drying. When the thimbles, so covered, had become dry to the touch, that is, in about 20 minutes, they were washed in water until they had no odor of ether.

The alkali, concentrated in the cathode chamber, will in time harden the membrane so that it breaks. It is, therefore, desirable with high-ash pectin to substitute a 0.1% nitric acid solution for the water running into the chamber. The nitrate ions will pass through the sol toward the anode. In doing so they should theoretically displace the more readily adsorbed fruit acid anions, by reason of their higher concentration, and should thus augment purification. If nitric acid is used, at the beginning of the process, water is returned to the cathode reservoir toward the end of the process to wash out excess nitric acid. One of the advantages of electro-dialysis, as compared with other methods, is the more efficient removal of fruit acid anions.

The resistance which the cell, used in Fig. 1, offers to the passage of a 110 volt drop, varies of course, with the concentration of the pectin and its electrolyte content. A 1% apple pectin containing .3% ash passed a current of about 0.1 ampere. The fall in ammeter reading is taken as a criterion of the progress of purification. Theoretically when the ammeter reading is the same as that given by the cell filled with water, purification is complete. Experimentally this point was not reached. The process was stopped when there was no further fall in ammeter reading.

Pectin, purified by electro-dialysis, is stored in dry form rather than as a sol on account of the danger of spoilage. Precipitation is accomplished by shaking the sol with twice its volume of 95% alcohol. The difficulty of spoilage during the electro-dialysis was overcome by adding a few cc. of mineral oil to the sol. This film over the top prevented the entrance of air molds and also cut down frothing caused by the air stirring. The action of mold in the destruction of jelly-forming power of pectin is quick and sure.

To reduce a 0.3% ash pectin to 0.1% ash in this apparatus required 72 hrs.

*Washing by Decantation:* By far the simplest method of purification and the one which yields the lowest ash pectin, is washing powdered pectin by decantation with 60% alcohol, acidified to 1% with nitric acid, until 100 cc. of the wash liquor evaporated to 1 cc. gives no test for calcium with a pocket spectroscope. The flame test cannot be relied upon since potassium will still be present because of its high concentration in apples. After the calcium is removed, the washing is continued with 80% neutral alcohol until the supernatant liquid gives no reaction with blue litmus.

The ash of apple pectin was reduced from 6.8% to 0.108% in three days with from 3 to 4 decantations per day. If the first step in this purification were continued until K, instead of Ca, were eliminated, the soluble ash left would be nil.

#### Ash Composition of Purified Pectin

The study of the ash composition of pectin purified by these three methods indicates that the elements which are preventing the preparation of an

ash-free pectin are silicon and aluminum. These two elements are the chief constituents of the ash left in the pectin purified by each process.

For this reason there may be a tendency for a given method to yield a "constant ash pectin" with a pectin sample from the same source. This is liable to happen in the electro-dialysis method due to the retention of certain inorganic substances in the colloid form. Thus the persistence of aluminum and silicon may be explained.

A "constant ash" tendency should be recognized as a possible limitation of the method and not necessarily as of chemical significance.

By electro-dialyses we were able to purify pectin to a 0.14% ash. Johnston and Denton reduced the ash to 0.18% by this method. A spectrogram of the ash of our purified sample showed that approximately 98% of it was Al, Si and Ti, the remaining 2% being Fe, Mg, Ca and V. Ti and V were not evident in the more complex spectrogram of the ash of unpurified pectin. If the Al and Si are present as the colloidal silicate, it is doubtful if electro-dialysis in our apparatus could ever reduce the ash much below 0.14. A membrane which would permit the passage of the silicate by cataphoresis would probably give rise to loss of pectin.

Pectin purified by three reprecipitations by alcohol usually retained 0.3% ash. The spectrogram of this ash, compared with that of the unpurified pectin, showed that the elements which resisted removal were Fe, Si, Al. When the pectin sol purified in this way was subjected to electrolysis using a revolving cathode about 1 cm. from the anode, a potential drop of 10 volts gave a current of 0.15 amperes. In four hours the ash of this sol was reduced about 20% and in eleven hours, about 40%. The chief deposit on the electrode was iron.

The greatest degree of purification was obtained by decantation washing with acidified alcohol. The ash was hereby reduced to 0.108% for which the spectrogram showed the same elements which were present in the unpurified pectin. The Ca, Mg, Na were removed more completely than Al, Fe, Si and K. This high K, in the purified pectin is in keeping with the fact that 56% of the ash of apples is potassium oxide. Electro-dialysis of this pectin should give an ash, containing chiefly Al and Si.

#### Jelly-forming Power of Purified Pectin

Pectin purified by all three methods had a satisfactory jelly-forming power as compared to that of the original pectin, but this was not taken too seriously because the amount of adsorbed acid was changed as well as the amount of adsorbed ash during purification. In both the reprecipitation method of purification and the decantation method, acid was used in the purification. Consequently the pectin resulting from these two methods required either less sugar or less acid to give a jelly of the same strength as the control jelly.

Pectin purified by the electro-dialysis method required either more sugar or more acid to bring the jelly strength up to that of the control jelly. At first glance this might seem to indicate that the pectin had been improved

in the two methods using acid and deteriorated in the electro-dialysis method. This does not necessarily follow. The whole difference may be in the initial acidity of the pectin sols and in the nature of the electrolytes retained by each method.

#### Quantitative Determination of Pectin

As yet we have no satisfactory method for the quantitative estimation of pectin. The methods<sup>1</sup> which have been variously suggested in the literature depend largely upon precipitation, with its inherent error in incomplete precipitation, precipitation of non-pectin substances, and inability to wash out excess precipitating agent without reprecipitating the pectin.

Volumetric measurements of alcohol precipitates of pectin are subject to the error involved in the type of precipitate, which varies with manipulation. The salt adsorption error characteristic of the gravimetric measurements of alcoholic precipitates may in a measure be corrected by ignition determinations, but the fundamental error of loss in precipitation and the precipitation of non-pectin substances makes this correction insignificant. Efforts to apply titration methods to products of pectin hydrolysis fail because of fading end point. Whatever the chemical reaction may be, the colloidal properties of the sol obscure it and make it valueless so far as an analytical method is concerned.

Jelly-making tests as a criterion of pectin measurements are of the greatest practical value but useless for scientific work because so many factors other than pectin affect jelly formation.

*Possibilities for a Colorimetric Quantitative Method for Pectin:* Botanists<sup>2</sup> have recognized certain dyes as specific for pectin in plant tissues, such as phenosafranin, methyl blue, bismarck brown, para violet. On this basis a valuable colorimetric method might be developed.

Many difficulties would arise in the development of such a method, for instance, the dye might not distinguish pectin from the intermediate "partially methylated" derivatives which are peptized by water; or the inorganic impurities might complicate the subject by forming lakes. However, it seems worth considering by someone who knows this phase of optical chemistry.

#### Bibliography

- <sup>1</sup> Quantitative Determination of Pectin. McNair: *J. Phys. Chem.*, 20, 633 (1916); Carre and Haynes: *Biochem. J.*, 16, 60 (1922); Johnston and Denton: *Ind. Eng. Chem.*, 15, 778 (1923); Campbell: *J. Ind. Eng. Chem.*, 12, 558 (1920); Paine: *Am. Food J.*, 17, No. 3, 11 (1922); Wickmann: *J. Am. Official Agr. Chem.*, 6, 34 (1922); 7, 107 (1923); Farnell: *Int. Sugar J.*, 25, 248, 630 (1923); 26, 4 (1924); Emmett and Carre: *Biochem. J.*, 20, 6 (1926); King: *Analyst*, 50, 371 (1925).
- <sup>2</sup> Stains. Wood: *Ann. Bot.*, 38, 273 (1924); Mangin: *Compt. rend.*, 109, 579 (1890); Tobler: *Chem. Centralbl.*, 1906, 1020; Howe: *Bot. Gaz.*, 72, 313 (1921); LaMarliero: *Rev. gén. Bot.*, 18, 209 (1906); Hunt: *Wash. Agr. Expt. Sta.*, 48, 201 (1918); Sucharipa: *J. Ass. Off. Agr. Chem.*, 7, 67 (1923); Paine: *Am. Food J.*, 17, No. 3, 11 (1922); von Fellenberg: *J. Chem. Soc.*, 110, 11, 351 (1916); Koydl: *Chem. Abs.*, 8, 3725 (1914); Nanj, Paton and Ling: *J. Soc. Chem. Ind.*, 44, 352T (1925); Correns: *Faserforschung*, 1, 22 (1921); Ahmann and Hooker: *Ind. Eng. Chem.*, 18, 412 (1926); Nanji and Norman: *J. Soc. Chem. Ind.*, 45, 337T (1929).
- <sup>3</sup> Purification. Poore: *U. S. Dept. Agr. Dept. Bull.* 1323, 1 (1925); Emmett: *Biochem. J.*, 20, 564 (1926); Griggs and Johnson: *Ind. Eng. Chem.*, 18, 623 (1926); Johnston and Denton: *Ind. Eng. Chem.*, 15, 778 (1923).

Cornell University

## NEW BOOKS

**Outlines of Biochemistry** By Ross Aiken Gortner. 23 X 15 cm; pp. xvi + 793. New York: John Wiley and Sons, 1929. Price: \$6.00. It is a pleasure to come across a book occasionally, which is written because the man knows his subject. In the preface the author says, p. vii: "In most of the universities of America the development of the field of biochemistry has been left very largely to the group interested in the medical aspects. Accordingly, in a very large measure the biochemistry of the American universities is not biochemistry in its strictest sense, but rather leans more and more toward the field of human pathology. Most medical school biochemistry could be more correctly designated as human pathological chemistry."

"It is obvious that there should be strong departments of physiological chemistry associated with the medical schools. However, it should likewise be recognized that there is a necessity for a study of the fundamental reactions underlying the broader field of biology, the primary object of which is to study and investigate the chemical and physico-chemical reactions which take place in the normal biological organism, whether that organism be animal or plant."

"The greatest advances in the biological sciences can take place only when the chemists are fully aware of certain of the biological problems and the biological point of view, and only when the biologists appreciate the assistance which chemical knowledge and chemical technic can offer to the solution of the major problems."

The book is divided into seven general parts: the colloid state of matter, 285 pp.; proteins, 177 pp.; carbohydrates and allied compounds, 126 pp.; the tannins, 8 pp.; plant pigments, 27 pp.; fats, lipides, and essential oils, 48 pp.; the biocatalysts, 55 pp.

The reviewer is inclined to think that Perrin worked with gamboge and not with gutta-percha. That does not affect the accuracy of the author's comment. "A gram molecular weight of Perrin's gutta-percha sol, containing  $62 \times 10^{23}$  particles would have a 'molecular weight' of 30,000,000,000 or approximately 350,000 tons, and this amount of disperse phase would have to be contained in one liter of dispersions medium in order to show a normal osmotic pressure and other properties characteristic of a normal solution. Obviously there is such a thing as a molecular weight of 30,000,000,000. The 'molecular weight' of colloid micelles is a misnomer, the more appropriate term being particle weight. In biochemical literature molecular weights of proteins as high as 200,000 are recorded. Probably here the more correct term would be particle weight," p. 58.

"Perhaps the most striking contribution to the recent literature of ultrafiltration is the observation by Kramer, who emphasizes that the nature of the charge on the colloid membrane had not been taken into account in previous studies of filtration. Kramer was interested particularly in the nature of the so-called filterable micro-organisms and viruses which pass unaltered through the porcelain filters of the bacteriological laboratory. He points out that all Berkefeld and Pasteur-Chamberlain filters are made from siliceous materials and consequently possess a negative charge. In testing such filters, he found that colloidal dyestuffs possessing a positive charge would not pass such filters, whereas those which were negatively charged passed readily. For example, Victoria blue (+) was retained in a Berkefeld filter, whereas Congo red (-) readily passed through. He, accordingly, attempted to prepare filters similar to the Berkefeld filter but possessing a positive charge. Using plaster of Paris ( $\text{CaSO}_4$ ) filters, he found no differentiation between acid and basic dyestuffs. When, however, a small amount ( $\pm 5$  per cent) of calcium carbonate was added to the plaster of Paris prior to forming the filter, he obtained positively charged filters which retained the Congo red (-) sols and allowed the Victoria blue (+) to pass through, thus reversing the retainability of the Berkefeld filter. A still more striking observation of Kramer is the fact that the bacteriophage of *Staphylococcus aureus*, the *Vibrio percolans* of Mudd, vaccine virus, and rabies virus are retained by the positively charged plaster of Paris filters, whereas they readily pass through the ordinary bacteriological filters."

As we shall see later in a discussion of the electrical properties of colloids, the retention is probably due to the mutual precipitation of oppositely charged micelles. Kramer's observations should open a new field in the study of virus problems," p. 70.

On pp. 108-112 there are valuable tables on the buffer action of certain solutions, and on pp. 196-197 there are interesting diagrams for the precipitation of a positively charged sol by a negatively charged one.

"Crowther and Haines have applied this method to a study of plowing. They point out that if the plowshare were made the cathode, being connected with an overhead power line, and the anode were imbedded in the soil of the field, it would be theoretically possible to lubricate the plowshare with a film of water so that the soil would never come in contact with the metal. They accordingly tested out this theory, using both laboratory-scale experiments and actual plowing tests," p. 128.

On p. 155 are data by Parker showing that solid alumina will lower the freezing-point of adsorbed water more than two degrees, of benzene more than one degree, and of nitrobenzene nearly two degrees. Silica lowers the freezing-point of adsorbed water nearly one degree.

"The affinity of Lloyd's reagent [hydrated aluminum silicate] for alkaloids is so great and such complete adsorption takes place that no bitter taste can be detected either in the mother liquor or in the Lloyd's reagent-alkaloid adsorption complex, when such substances as quinine or strychnine are adsorbed," p. 175.

"Laboratory tests of adherence on leaf surfaces proved very striking. If leaves were sprayed with the negatively charged arsenical and, after drying, were placed under a spray of water, practically all of the arsenical was removed within a few minutes. On the other hand, if leaves were sprayed with the positively charged preparations, and then, while still wet, were immediately placed under a spray, a very considerable amount of the arsenic remained on the leaves after several hours' washing. . . .

"In a personal communication to the author, Professor Moore gave the following results for a more extensive field trial. The positively charged arsenical was applied in a spray to the leaves of trees in the spring and when the leaves fell in the autumn after approximately 30 inches of rainfall, more than 20 per cent of the applied arsenic was found to be still adhering to the fallen leaves. It would accordingly appear as if positively charged insecticides and fungicides should be used for controlling insect pests and the fungus diseases. There would, of course, be a limit to their use, providing they were applied when fruit was on the tree, for by so doing the amount of arsenic adhering to the ripened fruit might introduce a dangerous factor," p. 200.

"The evidence appears to be entirely in favor of the brush-heap structure [of gels.] The only instance of which the author is aware in which a nonlyophilic substance readily forms a gel is dibenzoyl-L-cystine, as noted by Gortner and Hoffman. Using this material, they were able to prepare relatively rigid gels which contained only a small amount of the disperse phase. As little as 0.2 per cent of dibenzoyl-L-cystine formed a relatively rigid hydrogel and even 0.1 per cent formed a soft gel. Ultramicroscopic studies indicated that these gels were of a brush-heap structure, formed by the interlacing of relatively long crystals of dibenzoyl-L-cystine, the crystals being so thin as to have no apparent cross section. Dibenzoyl-L-cystine is not hydrophilic and does not crystallize with water of crystallization. The extreme minuteness of the crystal fibrils apparently formed an intricate net-work immeshing the dispersion medium. In spite of the fact that dibenzoyl-L-cystine does not have associated with it water of crystallization, it must nevertheless be regarded as a polar substance, due to the presence of amino groups, carboxyl groups, and the -S-S- linkage. We would accordingly expect it to attract water, a polar liquid," p. 208.

"Liepatoff has attempted to estimate the thickness of the water shell which was adsorbed onto the surface of a colloidal particle of the dyestuff, Geranin G. He estimated the thickness by the change in viscosity of known concentrations of dyestuff and water, and concluded that the radius of the dyestuff micelle is approximately  $4.9 \times 10^{-8}$  cm. and that this is surrounded by a water shell  $17.6 \times 10^{-8}$  cm. in thickness. The effective radius of the micelle and the water shell accordingly is  $22.5 \times 10^{-8}$  cm," p. 212.



"Many organic colloids show a great affinity for certain liquids and will take up such liquids against relatively enormous pressures. The pressure against which such a colloid will imbibe a liquid, or conversely the pressure which is required to force the dispersion medium out of a gel is known as the imbibition pressure. Imbibition pressures should not be confused with osmotic pressure, and in many instances they assume values greatly in excess of values obtainable by osmotic pressure. Thus, for example, dry seeds will, through imbibition pressure, withdraw water from a saturated solution of lithium chloride, which has an osmotic pressure of approximately 1000 atmospheres, although the salt content of the seed is sufficient to account for only a few atmospheres of osmotic pressure. Similarly, if a sheet of dried gelatin is placed in a saturated solution of sodium chloride, water will be withdrawn by imbibition forces against the osmotic pressure of the sodium chloride solution, and sodium chloride will crystallize out in the solution. The sap of plants in salt marshes or alkali flats may reach an osmotic pressure as high as 172 atmospheres (14.4° depression of freezing point), but such plants are not characteristic of the more extreme xerophytes, such as the cacti, where the osmotic pressure plays little or no role, and imbibition pressure becomes all-important," p. 216.

"The fats and lipides of living organisms exist in the form of emulsions. In the study of such emulsions, attention has been chiefly directed toward the fats, and relatively little attention has been given to the aqueous phase. Adipose tissue usually contains as much, if not more, water than it does fat, and in some instances it is possible to break down adipose tissue by the use of large doses of drastic diuretics more readily than to reduce obesity in any other way. Certain of the phosphatides, such as lecithin, are in themselves extremely hydrophilic and exist in the colloidal state and react as typical lyophilic colloids," p. 230.

"Robinson has shown that the amount of bound water in a series of insects is very closely correlated with the moisture content of the material upon which the insect feeds. Thus, as already noted, the granary weevil under normal conditions has a high bound-water content. The granary weevil, feeding on extremely dry material, stands at one end of the series, while aphids, feeding upon succulent leaves, are at the other end of the series and possess under normal conditions practically no bound water. Robinson concludes from this series of experiments that the ratio between bound and free water in insects regulates to a very large degree the rate of water loss from the insect. The granary weevil must have some mechanism which would prevent a rapid water loss and which probably even allows the insect to conserve the metabolic water produced by its own respiration. On the other hand, the aphids, drawing as they do extremely dilute juices from the plant, must evaporate large quantities of water from their body; otherwise the amount of nutrients which they could obtain would be extremely small," p. 241.

"The transfer of fluids from the digestive tract to the body tissues and the transfer of liquid from the body tissues to the digestive tract undoubtedly involve both imbibition and syneresis. A normal individual secretes from 700 to 1000 cc. of saliva per day, from 600 to 900 cc. of bile, from 600 to 800 cc. of pancreatic juice, from 1000 to 2000 cc. of gastric juice, whereas the water intake is usually only from 1000 to 1500 cc. Accordingly there passes into the digestive tract from 3.9 to 6.2 liters per day or from 4 to 6 times the amount of liquid that is taken in the form of liquid food, indicating that the water which is absorbed in the digestive tract is used several times over in the form of liquids which are secreted into the digestive tract. The passage of this relatively enormous volume of fluids from the digestive tract into the blood stream cannot be adequately accounted for by pure osmosis, since in many instances the contents of the digestive tract have a higher osmotic pressure than has the blood serum.

"Imbibition, however, can account for this transfer of liquid. The proteins of the intestinal wall take up the water from the intestinal tract and transfer it to the proteins of the blood stream, which in turn carry it to other portions of the body where their imbibitional capacity is lowered and where they yield the water to other tissues or glands. The crystalloids which pass from the digestive tract to the blood stream and from the blood stream to the various cells and tissues of the body can be regarded as diffusing through a swollen gel rather than moving by osmotic processes across a membrane. Those chemicals

which favor swelling of proteins, favor absorption from the intestinal tract, and those substances which hinder the swelling of proteins, hinder or prevent absorption from the intestinal tract. For example, magnesium sulfate more or less inhibits protein imbibition, and the effect of magnesium sulfate as a saline cathartic is to a large extent due to the prevention of the absorption of liquid from the intestinal tract, retaining the liquid within the tract. Similarly, agar, which furnishes bulk in cases of chronic constipation, is efficient because of its very pronounced hydrophilic nature, holding the water by inhibition forces against the pull of the intestinal wall and of the blood stream."

"In certain of the very deep mines where the temperature regularly exceeds 100°F. a very considerable proportion of the miners developed intense headaches, necessitating hospital treatment at frequent intervals. In these mines the miners worked practically nude, drank large quantities of water, and due to the high temperatures and humidities were continuously bathed in perspiration. It occurred to the physician in charge that possibly the headaches might be attributed to an excessive loss of sodium chloride through the perspiration, causing an excessive imbibition of the body tissues, including the nervous tissue. Accordingly the recommendation was made that instead of the usual supply of water, the miners be furnished drinking water containing salts in approximately the proportion of a physiological salt solution. The effect of such substitution was striking in the extreme. The epidemic of headaches, which had persisted for years, disappeared as if by magic, indicating that the excessive loss of salts in the perspiration had been the determining factor," p. 248.

"The theory of surface conductance still remains to be satisfactorily worked out. It appears that it may possibly be related to the specific surface area, *i.e.*, the colloidal nature of the material. Probably it is likewise influenced by the arrangement of the molecules of the dispersion medium or of materials present in true solution as oriented on the surface of the disperse phase. Briggs notes that surface conductance does not appear to be ionic conductance but instead is more nearly like metallic conductance," p. 276.

"It will be noted that when a relatively large amount of NaR is on one side of the membrane with a relatively small amount of potassium chloride on the other side of the membrane, there is almost complete transference of the K<sup>+</sup> ions from (2) to (1). Thus, a high concentration of NaR in (1) will separate almost completely the K<sup>+</sup> from the Cl<sup>-</sup> with which it was originally associated, carrying the K<sup>+</sup> across the membrane and selectively leaving the Cl<sup>-</sup> behind. *We have here an excretion of sodium and the selective adsorption of potassium across a membrane, due not to a differential permeability of the membrane but rather to the presence of ionic micelles on one side of the membrane.* It is entirely probable that the selective adsorption of potassium by plants from the soil solution or by marine algae from the sea water is due to a Donnan equilibrium, such as is noted in the above calculations. It may well be that some similar mechanism accounts for the excretion of urea through the tubules of the kidneys which appear to have a one-sided permeability" p. 282.

"In all of his studies on the proteins Fischer has emphasized the reactions which take place between a primary amino group and the carboxyl group of an organic acid. In his synthesis of the polypeptides, he has given us the peptide linkage,

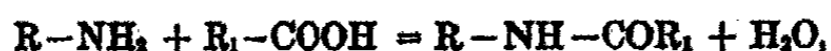

and it has been definitely proven that the peptide linkage occurs in the unaltered proteins. Probably due to the fact that Fischer emphasized this particular linkage, and due to the fact that Fischer's personality and research genius were so great, attention has been focussed by research workers almost entirely upon the amino and the carboxyl groups of the proteins, in an attempt to explain protein structure and protein reactions. There is a certain amount of definite evidence, however, that, while the amino groups and carboxyl groups are of primary importance, other groups and linkages other than the peptide linkage may and probably do occur in the unaltered proteins. A consideration of the reactive groups present in the various amino acids should indicate to any organic chemist the possibility of other reactions and other linkages," p. 299.

"Practically nothing is known in regard to the mechanism whereby amino acids are synthesized in the plant cell. As we shall see later, the entire animal kingdom is dependent upon the plant for the production of amino acids. *With the possible exception of glycine, the animal body or at least the tissues of the higher animals are incapable of synthesizing any single amino acid in quantities adequate for growth or maintenance.* The animal is accordingly dependent upon the plant for the amino acids which go to make up the muscle and vital proteins of the animal body," p. 306.

"Inasmuch as the synthetic polypeptides have in some instances been shown to be identical with the polypeptides isolated by the partial hydrolysis of proteins, we know definitely that the  $-NHCO-$  or  $-N=COH-$  group is present in the proteins. This fact, however, does not prove that the peptide linkage is the only linkage in proteins. In fact, polypeptide study indicates very strongly that it is not the only linkage, and while certain of the synthetic polypeptides are hydrolyzed by tryptic enzymes, none, insofar as the author is aware, are hydrolyzed by the peptic enzymes. Fischer concluded that the chains of the polypeptides were not long enough for pepsin to act upon them, but it seems more probable that pepsin attacks some linkage other than the linkage in the peptide group. Trypsin hydrolyzes proteins to their constituent amino acids. Pepsin hydrolyzes proteins only to proteoses, peptones, and polypeptides," p. 319.

Abderhalden says: "Each conception in regard to particular structural relations in proteins, and especially of those which are concerned in living processes, must take into consideration all their reactions, their ready transformation from the natural to the denatured condition, and their greater or less lability. It is certain that proteins in protoplasm have properties of which we are at present entirely unaware. We study proteins almost invariably in a greater or a less changed condition. On the one hand, we have proteins which in a certain sense are denatured in the organism, and outside of the organism undergo further changes. Thus, for example, we see the silk threads, the web of the spider, the byssus of certain muscles, etc., which are extruded as a liquid, changing to an inert solid. From a very labile form they are transformed into a very stable structure. In living processes we deal with the very reactive cell proteins which regulate in a fine degree the reactions of the cell, but when death ensues, the cell proteins coagulate and lose in a large measure their characteristic physical behavior," p. 346.

"The term, globulin, is assigned to a group of proteins, separable from other protein fractions of tissues by a purely arbitrary procedure. The globulins have been separated into euglobulins and pseudoglobulins on an equally arbitrary basis. When a globulin changes its solubility and is transformed into a protean, such as myosin to myosan, it is classified as a 'derived protein,' although nothing is known of the chemical change which has come about, and although the protean has practically all of the properties of the class of simple proteins, known as glutelins. No one can say that the glutelins are not proteans which have undergone the globulin  $\rightarrow$  protean transformation in nature," p. 368.

"Certain of the albuminoids are of special interest. Thus, *spongin*, the skeletal protein of sponges and coral, contains no tyrosine but instead 3.5 di-iodo tyrosine or gorgonic acid. The iodine content of spongin ranges from 1 to 1.5 per cent. It is interesting to note that the ancient Greeks considered ground sponges to be specific for goiter. This view, along with many viewpoints of the ancients, was held up to ridicule until recent investigations have shown that certain forms of goiter are due to lack of iodine. Modern investigation has shown that the iodine present in 3.5 di-iodo tyrosine is effective in the prevention of goiter, and dried ground sponges have again been listed as an official remedy in the French Pharmacopœia," p. 381.

"Gelatin is the only protein, insofar as the author is aware, which does not give the typical immunological reactions. It can accordingly be given intravenously without producing the deleterious effects which follow the intravenous injection of foreign proteins. During the World War, intravenous injections of gelatin were made in cases of excessive hemorrhage where considerable loss of blood in volume had occurred, the gelatin sols replacing for a time the blood proteins which had been lost, thus maintaining an increased blood volume, and the corresponding higher blood pressure which was desirable. Later

in the War the gelatin injections were replaced by injections of gum acacia which answered the same purpose. We have here an example of the importance of the lyophilic colloids in holding liquid in the blood vessels and maintaining normal blood volume. Bayliss has made the statement that by the use of gelatin and later gum acacia in cases of excessive hemorrhage, at least 20,000 lives of wounded men were saved in the Allied Forces alone," p. 301.

"Although a number of authors have claimed that if coagulation had proceeded only to the point of incipient turbidity, the reaction could be reversed by cooling the solution or removing it from the source of radiation and allowing it to stand for a time, Adolf, insofar as the author is aware, is the only person to claim a successful reversal of the complete heat coagulation process. She studied serum albumin purified by electro dialysis and found that the hydrogen ion concentration of the sol decreased from  $5.3 \times 10^{-6}$  to  $2.84 - 2.71 \times 10^{-7}$ , and the specific electrical conductivity increased from  $5.46 \times 10^{-6}$  to  $7.33 \times 10^{-6}$ , on heat coagulation. By dissolving the coagulated protein in dilute sodium hydroxide and subsequently removing the alkali by electro dialysis, she states that she regenerated a sol having all the properties of the initial serum albumin sol, including hydrogen ion concentration, specific electrical conductivity, optical rotation, temperature of coagulation, and protective value toward gold and mastic sols. If this be the case, it would appear that heat denaturation is not as deep-seated a process as other workers have indicated. The whole problem of protein coagulation requires further investigation but it seems probable that the change which is involved is so subtle as not to be readily amenable to the relatively crude methods used in protein research," p. 403.

"The first method of determining acid and alkali binding is the direct method of *precipitating out a protein compound*. This has been used by a number of workers, particularly those who have been dealing with the calcium compounds of casein, casein being titrated with calcium hydroxide to some definite end point as determined by some particular indicator, and then alcohol added to the system until the casein, containing a certain amount of calcium, precipitates. Using this method, one can obtain precipitates with different calcium contents, depending upon the indicator used. When litmus is the indicator, only approximately one-half as much calcium is precipitated with the casein as when phenolphthalein is used as the indicator. Accordingly it has been suggested that casein combines with different quantities of calcium to form the so-called 'monocalcium caseinate', and the so-called 'dicalcium caseinate'.

"The author believes that this method is incapable of yielding definite results. The indicator chosen will determine to a very considerable extent the amount of calcium hydroxide which must be added to a given amount of casein before the neutral point is reached. Accordingly it would be possible to precipitate an entire range of casein-calcium 'compounds' depending upon the indicators which were chosen, the range being from pure casein containing no calcium to casein saturated with calcium and contaminated with precipitated calcium hydroxide. In addition, the 'compound' precipitated with alcohol may or may not have a ratio of casein to calcium, identical with the 'compound' present in the solution prior to the addition of the alcohol," p. 412.

The modern belief is that "the amino acids are transported as such in the blood stream to the various cells and tissues, where such as are needed are resynthesized into the proteins characteristic of those cells and tissues," p. 426.

"Wells has observed that the globulin from the seeds of the cantaloupe is immunologically identical with the globulin from squash seeds and that the caseins from the milk of animals of different species show very close biological relationships. The same is true of the vitellins of the egg yolk from various species of animals. Wells notes that casein from the milk of an animal of any given species shows a closer biologic relationship to the casein of another species than it does to either the whey proteins or the serum proteins of its own species, and that egg yolk proteins from even such widely different species as fish and turtle may give precipitin reactions with the antiserum for hen egg yolk proteins," p. 436.

"Histamine has been found by Abel to be the poison secreted by the skin of the African toad. Toad skin, according to Pliny was a medicine. Abel showed that it contained a

powerful drug. This is an additional instance where one of the old folk remedies was found to be not so foolish as it appears to be," p. 445. Nothing is said about warts.

"Muscarine is the poison of the 'fly mushroom' or 'fly agaric,' *Amanita muscaria*. This mushroom was Caesar's favorite poison because it resembles so closely *Amanita caesarea* which is edible. He accordingly had *Amanita caesarea* served to himself, and *Amanita muscaria* served on certain occasions to his guests," p. 449.

"It is difficult to formulate an exact definition of an alkaloid. The definition may be made so broad as to include all nitrogen-containing compounds or so narrow as to leave out compounds with definite alkaloidal properties. Ladenberg originally defined them as "those naturally occurring vegetable substances of a basic character which contain at least one nitrogen atom forming a part of a heterocyclic ring." If we accept the purine and pyrimidine bases, we can limit the definition to "basic substances found in plants and which contain a cyclic nitrogenous nucleus." Even this is too narrow, for a few compounds do not contain a "cyclic nitrogenous nucleus," nevertheless they may have the marked physiological properties of alkaloids. The modern chemist may well take exception to the words, "naturally occurring." We have prepared synthetically medicinal substances which are better than the natural alkaloids, and these synthetic products are truly alkaloidal, both in chemical and physiological properties, if we accept chemical and physiological properties as criteria of alkaloids. No definition, accordingly, can be completely satisfactory. Ladenberg's definition is fairly satisfactory as applying to those alkaloids which occur in nature," p. 456.

"From the historical standpoint coniine is an interesting alkaloid inasmuch as Socrates was supposed to have died from the effect of coniine in his drink of the deadly hemlock," p. 460.

"Solanine is obtained commercially from the juice of potato sprouts. Under ordinary conditions, potatoes seldom ever contain enough to produce toxic effects, but certain strains of potatoes contain appreciable amounts, 'Sunburned' potatoes are nearly always bitter and contain an increased quantity of solanine. Death may result, if a considerable quantity of such tubers are eaten, especially if they are baked and eaten 'in their jackets'. Potatoes normally contain about 0.024 parts of solanine per 1000, but sunburned potatoes have been found to contain as high as 0.588 parts per 1000. Approximately 70 per cent of the solanine is removed in the parings," p. 466.

"Fructose, the sweetest of all the sugars, occurs free in most fruit juices. Honey is largely 'invert sugar' and owes its superior sweetness to the fructose content. Its polysaccharide is inulin, the reserve carbohydrate in the tubers of the dahlia, chicory, and the Jerusalem artichoke. Various 'inulides' also occur, usually associated with the true inulin," p. 539.

"Melezitose is an exceedingly rare sugar. It is composed of three molecules of glucose and can be hydrolyzed to yield glucose and a disaccharide, turanose. Melezitose occurs in the sap of the larch, Douglas fir, scrub pine, etc., and under certain conditions, especially following attacks by sucking insects, these trees exude drops of sweet sap which harden into a more or less true 'manna'. In periods when nectar is scarce, bees may store this 'honey dew' as a substitute for honey. This was the case in the dry summer of 1917 in certain portions of the eastern United States when the clover blossoms quickly dried because of drought. The following winter, many bee colonies throughout this area died. The 'honey' in these hives had crystallized. The Bureau of Chemistry of the United States Department of Agriculture undertook an investigation as to the cause of the death of the bees and found the 'honey' to contain very large quantities of melezitose," p. 549.

"The value of potassium as a fertilizer is at least in part due to its functioning importantly in starch formation. Potassium is apparently necessary in the reaction whereby glucose, the product of photosynthesis, is transformed into starch, the reserve food material. The nature of this reaction, however, is almost wholly unknown. From the standpoint of physical chemistry, it is essential that the plant transform the glucose into a higher polymer, such as starch, as a reserve food supply. In so long as glucose is present in solution, the osmotic pressure within the cells must be at least proportional to the glucose concentration. When, however, the glucose is converted into the relatively insoluble and osmotically-

inert starch, a large reserve supply of food materials may be stored without unduly affecting the osmotic relations of the tissues," p. 556.

"Although the cyanogenetic glucosides are somewhat rare as compared with saponins, they have a much wider distribution than was once supposed, and are present in many economic plants. Flax contains a small amount of HCN in the dry seed (0.008 per cent HCN), but as much as 0.135 per cent has been found in the germinated seedlings. The same increase occurs in the germination of bitter almonds. The stage of development at which the maximum amount is reached may be different for different plants. Thus, in flax the maximum occurs when the seedlings are 4 to 5 inches high, while in *Lotus arabicus* the maximum is at the time of flowering. In sorghum there appears to be no HCN in the seed, but Willaman found the maximum amount in seedlings about 3 inches high, decreasing to practically zero in the mature plant. During the first three weeks the HCN was concentrated in the stalks, then passed largely to the leaves, and persisted there more or less until maturity. The temperature and soil condition play a major part in determining the amount of HCN in sorghum; cold, wet days in the early growing period markedly increase the HCN content and cold days in the fall cause the reappearance of HCN. This is particularly true of 'suckers' in a sorghum field just before or after frost. Frost naturally breaks down cell permeability and permits the enzyme to hydrolyze the glucoside, so that cattle are readily poisoned in a sorghum field following a frost. Horses are much more resistant to the toxic action of HCN," p. 574.

"All of the saponins are characterized by marked physiological action and toxic properties. Fish, in particular, are extremely sensitive, being killed by 1:100,000 solutions. Most of the fish poisons of the aborigines are saponins. They exhibit a solvent action on red corpuscles, causing hemolysis. The hemolytic effect is possibly due to a withdrawal of cholesterol from the corpuscle wall," p. 581.

Oppenheimer says, p. 719. "All that we know of the nature of enzymes, and even our very meager first insight into a future structural chemistry and its apparent dependency upon colloid chemical behavior can only be measured by their activity, and the classification of enzymes is likewise based upon this same criterion. In enzyme classification there is no hint of the chemical structure of the enzymes or of the interrelation of specific chemical groupings and the reactions which occur. One must again reiterate that from the purely chemical viewpoint, there is no possibility of arriving at a definition of enzymes, for the definition deals only with activity, the activity of a catalyst produced by living organisms."

"Perhaps the most striking of the recent work are the observations by Nord and Franke that minute traces of ethylene gas dissolved in water protect the fermentation enzymes of yeast against inactivation. They were able to markedly increase the activity of zymase preparations by bubbling ethylene through the solution and were able to demonstrate that solutions treated with ethylene maintained for a long period of time their ability to ferment glucose. The active fermenting system of zymase and sugar did not bring about the rapid inactivation of the enzyme which was present. Accordingly, Nord and Franke suggest that ethylene acts in this instance not as an activator but rather as a protector, and that in all probability the various experiments in the literature which have been reported as dealing with enzyme activation, should be interpreted as experiments dealing with enzyme protection, the apparent increased activity being due to the inhibition of enzyme destruction. This view appears to the author to be a logical one, assuming, of course, that the other physical factors in the environment have been kept constant. Undoubtedly, at least a part of the effect of hydrogen ion concentration is due to an increase or decrease of the effective surface of the colloidal enzyme, but at a fixed hydrogen ion concentration and a fixed salt concentration it would be logical to interpret the effect of substances which activate enzymes in the same way that the action of protective colloids is interpreted," p. 730.

Gortner is in good company when saying, p. 20, that "micelles are usually negative when in contact with a liquid having a high dielectric constant, and positive when in contact with a liquid having a low dielectric constant." Whether a substance is charged positively or negatively is a question of selective adsorption. A high dielectric constant may increase the number of ions; but it is not clear why it should affect the selective adsorption.

On p. 173, Gortner says that one of the commoner ways of activating charcoal was "to heat the charcoal for a time in a current of steam, and later heat in a closed container to 700° to 800°C. The reviewer's recollection is that this was one operation and not two; that steam was passed through charcoal heated to about 900°.

In his guileless ignorance the reviewer had thought that he had rather put emulsions on the map; but Gortner is quite convinced of the contrary.

Wilder D. Bancroft

**A Text-Book of Inorganic Chemistry.** Edited by J. Newton Friend. Vol. XI. Part I. 82 × 16 cm; pp. xxx + 418. London and Philadelphia: Charles Griffin and Company, J. B. Lippincott Company, 1928. Price: \$14.00. The book is written by Archibald Edwin Goddard and Dorothy Goddard. In the preface the authors say: "The present book aims at giving a tolerably complete account of the preparation and properties of the organic compounds of the elements of Groups I to IV of the Periodic Classification. Except in the case of mercury, no monograph has appeared in any language which deals with the organic compounds derived from the elements of these groups. The term *organometallic* as used in this volume is applied only to compounds containing a second element directly linked to carbon, and excludes those where the element is linked *via* oxygen or nitrogen, as well as double compounds of organic substances with inorganic salts. In spite of these omissions, the present volume gives an account of approximately 2300 compounds. In order to make the book as complete as possible, the preparation of all *key* compounds has been given in detail, and it may be used as a treatise on practical organic chemistry. Since it has been necessary to cover so much ground no systematic attempt has been made to enter into theoretical aspects of the subject, but by endeavouring to include all known compounds chemists will be able to make valuable comparisons of the compounds of the various elements, which was hitherto impossible without consulting a vast amount of original literature. To make the text more readable, physical constants of large series of compounds have been placed in the Appendix, and throughout the book greater attention has been paid to physical properties generally than is usual in this type of book. The Authors' experience has shown that such data would have been very useful in their own research work if it had been available in book form."

There are four chapters on the organometallic derivatives of Groups I-IV; seven chapters on mercury; and one each on the organometallic derivatives of tin and of lead.

"The three elements lithium, sodium, and potassium bear little resemblance to copper, silver, and gold in their inorganic derivatives; but, with the exception of gold, they show more resemblance in their organo-metallic compounds.

"Lithium, sodium, rubidium, and caesium form two types of compounds, (1) RM, (2) RC<sub>3</sub>M, whilst potassium only gives type (2). Lithium and sodium derivatives of type RM are prepared by treating the corresponding mercury alkyls or aryls with the metal in dry benzene or ligroin. Rubidium and caesium, however, are obtained by interaction of the metal and zinc alkyls. Lithium methyl is best isolated from lithium ethyl and mercury dimethyl in gasoline solution. The most striking property of these metals is their affinity for oxygen, and this property is also exhibited in their organo compounds for they are inflammable in air. The lithium compounds are more crystalline than those of sodium, but the latter are more insoluble in indifferent solvents. It is interesting to note that whilst lithium and its inorganic salts colour the flame red, lithium phenyl burns with a yellow flame.

"Schlenk and Marcus in 1914 found that triphenylmethyl chloride reacted with sodium amalgam in dry ether solution, when the operation was carried out in an atmosphere of nitrogen. The resulting compound, sodium triphenylmethyl, was a brick-red mass, decomposed by moisture or carbon dioxide. Kraus and Kawamura in 1923 showed that triphenylmethyl chloride reacts with sodium and potassium in liquid ammonia, but that the potassium compound is more stable than the sodium derivative. A number of compounds similar in structure to triphenylmethyl have since been shown to give similar reactions. Rubidium and caesium also form similar derivatives.

"Copper, silver, and gold are contrasted with the three foregoing elements in being stable towards air, water, and some acids, and in these respects bear some analogies to the metals of Group VIII. In organo-metallic chemistry, this likeness is only shared by gold, since this is the only element that forms stable compounds. Copper and silver phenyls have been reported by several investigators, but they are very unstable compounds and little is known about their general behaviour. It will be noted that this instability is shared by the phenyl derivatives of the alkali metals.

"Gold forms two trivalent types of compounds,  $R_3MX$  and  $RMX_3$ , both of which are fairly stable solids. Type  $R_3MX$  shows the analogy between gold and thallium, the latter metal giving only this type of organic compound; moreover, no monovalent derivatives of gold or thallium have been isolated. Diethylauric bromide is prepared by the interaction of auric bromide and magnesium ethyl bromide, and this substance is changed to the second type by treating it with bromine in chloroform solution, the halogen replacing one of the ethyl groups. Both compounds precipitate silver bromide from solutions of silver salts, and the diethylauric bromide forms an addition compound with ammonia, when warmed with its aqueous solution. No aryl derivatives of gold have yet been obtained, although when isolated they will be found to be quite stable, and probably have no melting-point below  $300^\circ\text{C}$ ., like the corresponding thallium compounds," p. 3.

"Unlike the preceding compounds, sodium benzyl is isolated as an intense red, crystalline powder, insoluble in benzene or ligroin, but fairly soluble in ether, to which it imparts a deep, reddish-yellow colour. The ethereal solution will conduct the electric current, showing that the metallic atom is linked by a carbonium valence. It inflames in air, but if the oxidation is slow, much stilbene is formed. Dry carbon dioxide converts it into sodium phenyl acetate," p. 6.

"Cuprous iodide is added to a cold solution of magnesium phenyl bromide in ether. Complete solution takes place, and after a time the cuprous phenyl separates out as a white powder. It decomposes at  $80^\circ\text{C}$ . and when warmed with benzene is converted quantitatively into diphenyl and metallic copper, the latter appearing as a mirror. With water, benzene and cuprous oxide are formed, and with dilute nitric acid it is changed to nitrobenzene, concentrated nitric acid causing the compound to explode. Cuprous phenyl blackens in a few days, even when kept in a vacuum," p. 9.

"Mercury diphenyl and magnesium powder are heated to  $200^\circ\text{C}$ . in an atmosphere of nitrogen, when the magnesium compound is isolated as a white powder. It is insoluble in carbon disulphide or benzene, but soluble in absolute ether, and when boiled in the latter solvent in a stream of hydrogen, filtered and evaporated under  $5^\circ\text{C}$ ., the compound crystallises in transparent feathery needles. These contain ether of crystallization which may be removed by the heat of the hand, an amorphous product resulting. It burns in air, forming magnesium oxide, and by slow oxidation gives  $\text{Mg}(\text{OPh})_2$ . Water decomposes magnesium diphenyl with the formation of benzene and magnesium hydroxide. Bromine in ethereal solution forms bromobenzene and magnesium bromide, no magnesium phenyl bromide being isolated. With phosphorus trichloride only traces of diphenyl phosphorus chloride are formed. Benzal chloride reacts with the compound when heated for three hours in a sealed tube at  $100^\circ\text{C}$ ., giving triphenyl methane and magnesium chloride. When magnesium diphenyl is heated in a sealed tube at  $280^\circ\text{C}$ . until it decomposes, the principal product obtained by extraction of the product with benzene is diphenyl."

It is not clear, pp. 287-289, what the composition of the dark-blue silicon compound is. On pp. 291-298 the germanium compounds were, most of them, prepared in the Cornell laboratory. On p. 333 the authors say that lead tetra-ethyl "is now used industrially for mixing with the fuel of explosion motors, as it allows greater compression without the dangers of self-ignition." The authority for this remarkable statement is Jolibois and Normand. Midgley's name does not appear in the index.

*Wilder D. Bancroft*



**Fluorescenz und Phosphorescenz. Struktur der Materie. By Peter Pringsheim. Volume VI. Third edition. 22 × 14 cm; pp. 357. Berlin: Julius Springer, 1928. Price: 24 marks; bound 25.20 marks.** The third edition of this well-known work is especially welcome in view of the prominence of the phenomena of fluorescence in modern physics and chemistry. In reading the pages dealing with the fluorescence of organic compounds it is at first sight peculiar to find that there is no reference to the work of Raman, but when it is remembered that this book deals only with investigations up to August 1927, the omission is readily understood. It may be stated at once that the volume loses little by this, for it deals with those conditions of the absorption and emission of radiation which depend to a large extent on the natural frequency of the medium and the emitted radiation resulting from the return of the medium to the normal state, and with the conditions governing resonance effects. The relation of the scattered radiation to the infra-red frequency of the molecules is not here in discussion, so that the volume may be considered to concern those phenomena of light absorption and scattering which are not considered in the "Raman" effect.

The introduction deals with the distinction between fluorescence, phosphorescence and photoluminescence, distinguishing in the latter case between the pure resonance of gases and the phosphorescence of solids and liquids. A sufficient general account of experimental methods is furnished and the author rightly leaves details to be dealt with in their proper places as the necessity for them arises. A short account of the nomenclature of line spectra is given with some examples. This account is naturally short and should be read in conjunction with the schemes formulated in other volumes of this series. In the third chapter the simple elementary theory of resonance and band spectra is outlined insofar as it may be applied to diatomic molecules. It is considered in some detail for iodine vapour, and for some other cases of homopolar and heteropolar gases and vapours. The discussion of the resonance and metallic vapours is largely descriptive, as would be expected from the character of the data available.

A very important chapter is that dealing with the persistence of fluorescent radiation of gases and with the effect of magnetic and electric fields. The important work of Gaviola here comes into consideration and naturally leads up to questions of polarisation of resonance radiation in the magnetic field and to the Stark effect. Hanle's work in this connection receives full recognition. A most important section is that dealing with the alteration of resonance radiation by collision, the different possibilities being discussed from various aspects such as metastable states, change in intensities of fluorescent lines on addition of various foreign gases, possible suppression or weakening of fluorescence by collision, the effective cross-sections of molecules and extinction of fluorescence bands, effects of pressure on the polarisation of resonance radiation, and on the duration of fluorescence. While one would have liked a little digression at this place on the Ramsauer effect in general, it was perhaps scarcely the function of the author to deal with the subject in this particular volume.

"The transference of the energy of excitation to another atom by collision can be clearly followed up, if the atom collided with is thereby transposed into an excited state from which it can emit the energy received in the form of radiation of its characteristic frequency." This free translation of a sentence on page 136 gives the essence of the effect called "sensitised fluorescence" by Cario and Franck, the prime investigators of the process; and as Pringsheim points out the term is quite as good as any of the alternatives proposed for the process in question. The effect of the Hg resonance line 2537 Å on various gaseous substances is described and an excellent reproduction of the "sensitised fluorescence" of Indium vapour is shown.

The distinction between fluorescence and phosphorescence of liquids and solids is given in great detail in Chapter 6. The investigations of the polarisation of fluorescent radiation is treated here and in many other places in the volume. The importance of this phenomenon in considerations of anisotropy of molecules is fundamental and needs no further stressing. Lenard's work on phosphores, as well as the older work on uranium solutions, receives the attention it is entitled to in any work on this subject. Various kinds of sul-

phide phosphores, and the photoelectric conductivity of crystals are discussed, as well as the quenching of phosphorescence by infra-red radiation. Photochemical theories are dealt with very briefly, as one expects from a cautious experimenter.

Chemists will turn to the chapter on fluorescence of organic substances and will find here much information on the fluorescence of benzol at various temperatures. The treatment follows to some extent that of Henri's well-known investigations, the work of Stewart and Marsh on luminescence spectra being considered briefly. A good deal of space is usefully devoted to dyestuffs and to the effects of concentration and solvents. This section has some discussion on the subject of production of fluorescence as a result of chemical change and many examples are quoted to show that in certain cases the evidence is in favour of such a view. On the other hand there are numerous examples where the addition of neutral substances may induce fluorescence. The constitution of the fluorescing molecules is unquestionably involved in these cases, but apart from the effects of certain types of ring structure, the processes involved are too complicated to permit of any far reaching generalisation.

Chapter 8 is an account of the luminescence of complex inorganic salts, largely uranium salts. Despite the numerous investigations undertaken on uranium salts, perusal of current literature shows that the subject is still in an active state and the 17 pages or so devoted to the matter here are indispensable as an introduction to this study. The difficulty of this study may be indicated in the sentence at top of page 249, which points out that despite the close connection between phosphorescence and spectral absorption, the distribution of radiation producing luminescence even in uranium salts is not limited to those frequencies which correspond with the selective absorption.

The subject of solid phosphorus is considered in Chapter 9 and the classical work of Lenard receives full attention. This chapter repays close study. It is full of interesting observations and discussions, and describes the application of X-ray methods of study directed towards the elucidation of differences between phosphorescent and non-phosphorescent crystals. The phosphor, ruby ( $\text{Al}_2\text{O}_3$ ), is now one of the older cases of the effect of impurities. It is a most striking fact that as little as 0.003% of chromium oxide is effective in producing the strong ruby fluorescence in colourless alumina.

The volume ends with a list of over 600 references to the literature of the subject up to August 1927. Since that time the investigation of fluorescence, its polarisation, duration, incidence and so on have received intensive study everywhere. It may fairly be stated that this volume is now indispensable to students of physics and chemistry and to investigators generally, for it is from this study of fluorescence that the reader is enabled to proceed to the closely allied subject of absorption and scattering—the Raman effect.

*J. J. Fox*

*Proceedings of the Seventh International Congress of Photography. London, 1928. 25 × 15 cm; pp. xiv + 571. Cambridge: W. Heffer and Sons, 1929. Price: 25 shillings. About seventy papers were communicated to the Congress. These are printed in full together with the discussions.*

Much time and energy was spent in dealing with the problems of sensitometry. Substantial agreement was reached concerning proposals for an international standard light source for the testing of negative materials. The source is to consist of a lamp, burning at a colour temperature of  $2360^\circ\text{K}$  and screened by means of a two-cell filter by which the quality of the light is corrected to resemble approximately that of Abbott's values for mean noon sunlight. This proposal is based on work carried out by R. Davis and K. S. Gibson of the Bureau of Standards who worked in collaboration with a Committee appointed by the Optical Society of America. It remains for this to be ratified by the National Committees concerned before its final acceptance by the next International Congress of Photography to be held at Dresden in 1931. No developer for sensitometry has yet been accepted as a standard but S. E. Sheppard and A. P. H. Trivelli describe an experimental comparison of some developers for sensitometric standards. Other problems of sensi-

tometry, both theoretical and practical, are dealt with in a series of no less than six papers from the Kodak laboratory and in another paper by R. Luther, W. Seifert and W. Forstmann. L. A. Jones and V. C. Hall describe the general results of work "On the Relation between time and intensity in Photographic Exposure." O. Sandvik gives a paper "On the measurement of resolving power in photographic materials."

Several papers describe important original investigations having rather more general scientific interest. Two of these may be mentioned. F. C. Toy describes experiments which go far towards proving that the first action of light in forming the latent image in silver emulsions is the same as that which produces changes of electrical conductance in silver halides on illumination. For this reason a study of the photo-conductance effect in silver halides will probably clear up many of the mysteries about photographic sensitivity. Chemical analysis has not yet been made delicate enough to deal with the latent image and therefore the opening of a new avenue of attack creates a lively feeling of expectation in those engaged in this field of research.

The optical properties of disperse systems are extremely complicated. Any attempt at bringing order amongst the somewhat chaotic ideas existing about this subject is therefore to be welcomed. B. H. Crawford, E. R. Davies, B. Farrow and F. C. Toy have made an excellent beginning in this subject with the work described in a "Report on Turbidity with special Reference to its Application in the Photographic Industry." One of the main applications is the determination of average particle size in suspensions by a simple and rapid optical method involving the measurement of the scattering of light. It may be noted that the full understanding of the problems discussed in this paper must be of great importance for the paints and pigments industry.

Several summaries of great value in various scientific fields of work are given. H. N. Ridyard contributes a great deal of exact information about light sources and energy measurements. This will be appreciated by those who are working on problems of photochemistry because the paper indicates many of the errors of experiment which tend to pass unnoticed and so vitiate much work which is otherwise good. A few other papers may be mentioned: "The testing of photographic Shutters" by J. S. Anderson; "A photographic Method of investigating the Colour of light sources and the reflecting power of coloured fabrics and other substances" by P. W. Cunliffe and F. D. Farrow; "Modern Spectrography" by L. J. Freeman; "Fine grain developers and their application to Spectrography" by E. Viterbi. In the last mentioned paper a photograph is reproduced which shows at a magnification of 95 diameters a clear separation between the images of the lines 2625.79 and 2625.60 Å.

In the colour photography section two papers call for special notice: "A new colorimeter of the subtractive type" by R. A. Houston and "The determination of the colour sensitivity of Photographic plates" by A. Hübl.

A series of papers by D. A. Spencer describes the way in which diazo compounds are used in the preparation of new sensitive papers which are said to be better than the well-known "blue-print" papers commonly used for the reproduction of plans, drawings, etc.

*S. O. Rawling*

**Photo-Processes in Gaseous and Liquid Systems.** By R. O. Griffith and A. McKeown. 22 × 14 cm; pp. viii + 691. London: Longmans, Green and Company, 1929. Price: 25 shillings. The authors of this book are already known favourably to workers in the fields of photochemistry and chemical kinetics by their researches on certain of the reactions of ozone, work characterised by a just perception of the real points at issue and by an unhurried and thorough experimental treatment. They have now put us under a very real obligation by the writing of a book which gives evidence throughout of the same or similar qualities; to wit, great but discriminating industry, a nice comprehension of essentials, a critical acumen above the ordinary, and unlaboured and clear expository style.

The book essentially falls into two parts. The first, slightly smaller, half deals with the physical bases of the subject, viz. the quantum theory; atomic structure; the production

and nature of "excited" atoms; molecular spectra and their significance; fluorescent phenomena. A chapter on chemiluminescence serves as approach to the chemical aspects of the subject. Here we first have an introductory chapter dealing with the main facts from a general and experimental point of view. There follows a full treatment of reaction mechanism regarded in the light of the Stark-Einstein photochemical equivalent relation. The hydrogen-chlorine and carbon monoxide-chlorine reactions are then fully discussed (the literature is quoted up to a late date in 1928, with occasional references to the early months of 1929) and finally we have a chapter on Photosensitization, and one dealing with such subjects as catalysis, Inhibitors, Temperature Coefficients and After Effects. There is a short appendix on the chemical effects of X-rays,  $\alpha$ -particles and electrons, and there are full subject and author indexes.

At the moment, Photochemistry is in a state of rapid development. Experimental methods have been much refined in the course of the last few years. Our knowledge of the actual facts is fast becoming more precise, as well as more extensive, and many of our ideas on the experimental characteristics of photochemical phenomena have had to undergo modification. Still more important has been, and continues to be, the profound influence on the whole point of view of photochemical theory exerted by certain recent and current advances in optics and in atomic and molecular physics—more particularly by work on the analysis and interpretation of spectra and on the excitation and de-excitation of atoms and of molecules. The papers read at the recent Faraday Society symposium on Molecular Spectra make it abundantly clear that this influence will continue to be felt during the coming years.

This being the case, it follows that a book of the present dimensions and scope is only justified if quite exceptionally well done. The volume under discussion can make this claim. The reviewer cannot remember reading a clearer presentation of the recent advances in physics just referred to than is contained in the first half of this book, all of which is of vital interest to the photochemist. The treatment accorded in the second part to the vast mass of available experimental data—data of every degree of value and significance is equally admirable in its discretion and judgment. And the present writer finds himself in continual agreement with particular conclusions of the authors; for example, the urgent need of intensive work on the interpretation of the absorption spectra of liquid solutions, the growing necessity of a fully developed micro-analytical technique and so forth.

The only drawback the book suffers from is one already hinted at, and inherent in the present state of the subject. Certain very recent discoveries which have already proved their importance are perforce unnoticed. For example, there is no mention of the Raman effect. Again, the absence of a reference to the work published during the last twelve months from the laboratories of Bodenstein, Chapman, and Semenov on the effects of the vessel wall in such reactions as the combination of hydrogen with chlorine and with bromine, definitely "dates" much of Chapter X. The experiments of Norrish on the mechanism of the decomposition of nitrogen peroxide are also, necessarily, unmentioned.

But the fact remains that this volume should be bought and read—the sooner, the better—by all research workers and others interested in Photochemistry.

A. J. Allmand

## PHASE RULE STUDIES ON THE PROTEINS. I\*

BY WILDER D. BANCROFT AND C. E. BARNETT

### Determination of Solid Compounds with Hydrogen Chloride or Ammonia

#### I. Introduction

In 1912 T. Brailsford Robertson<sup>1</sup> took the definite stand that proteins form true and not colloidal solutions with water and that the proteins react with acids and bases in stoichiometrical proportions with the formation of definite chemical compounds. A review of the book<sup>2</sup> gives a criticism of the author's viewpoint. "In the preface the author says: The investigations of recent years on the behavior of proteins and of colloids in general have resulted in building up two schools having markedly different views. Except where prevented by technical difficulties, one school tries to apply the well-known laws of what may be called molecular-physical chemistry direct to proteins and to other colloids, while the other school objects to doing this. So far as the proteins are concerned, it seems to me that the important point at issue between the two schools is whether we are or are not justified in assuming that Avogadro's law applies to solutions of proteins. In other words, are protein solutions molecular-disperse systems or are they suspensions or emulsions? The second of the two schools, as a result wholly or in part of a priori conclusions, believes that Avogadro's law cannot be applied to protein solutions, or at least that its validity should be shown before we attempt to apply it. The first of the two schools believes in assuming that Avogadro's law is applicable until direct proof to the contrary is shown." The author has therefore presented the subject of the proteins on the basis that we are dealing throughout with true solutions. It is a very clever piece of work and one must regret that so much ability has been wasted on a false thesis. The author might have written a book which would have been a standard for all time. In the opinion of the reviewer, the author has merely shown how easy it is to prove that black is white. The reviewer owns up to having been carried off his feet once or twice. . . .

"The reviewer would like to see the author display his versatility by re-writing the book from the other point of view. No one else could do it so well, just as no one else could have written the present work so well. Granted the point of view and the book is a masterly presentation. The subject has been treated so well and so consistently that the burden of proof is on the man who says the point of view is wrong—in other words on the reviewer. He expects some day to make his position good."

\*This work is part of the programme now being carried out at Cornell University under a grant from the Heckscher Foundation for the Advancement of Research established by August Heckscher at Cornell University.

<sup>1</sup> "Die physikalische Chemie der Proteine" (1912).

<sup>2</sup> Bancroft: J. Phys. Chem., 16, 704 (1912).

In the preface to the English edition, Robertson<sup>1</sup> repeats the remarks quoted from the German edition and amplifies them as follows: "The colloids are therefore an exceedingly heterogeneous group, the only common distinguishing characteristic being the relatively enormous mass and volume of the molecules of the most 'typical' representatives of the class, and of course as many gradations of behavior exist as there are gradations in mass and volume of molecules. Nothing is to be gained, therefore, by trying to force the various members of the colloid group into artificial conformity with definitions, which are designed to separate them, as if they were a homogeneous group, from other classes of chemical substances. To describe a particular property or mode of behavior as a 'colloidal phenomenon' neither defines nor interprets it and furthermore fails even to describe it, since there are no phenomena which are distinctively 'colloidal' and displayed by every member of the colloid group, saving only these phenomena which depend primarily on the simple factor of the mass or volume of the molecules, and which are therefore predictable from and implied in the properties or behavior of the smaller molecules of the non-colloidal substances."

"Similarly the use of the term 'adsorption' to describe the union between colloids and other substances implies a uniformity where no uniformity exists and is, moreover, devoid of utility or meaning unless we attach to the definition some distinct idea of the nature of the underlying forces which condition the union, whether the forces be regarded as consisting of chemical (i.e., atomic) attractions or of capillary (i.e., molecular) attractions. But in forming such concrete ideas we are simply returning to conceptions which are already familiar to us in the 'crystalloid' field of chemistry and which call for no definitions which we do not already possess as the result of our general acquaintance with the physical and chemical phenomena which are displayed by simpler and hitherto more familiar substances."

Loeb followed the lead of Robertson. In the preface of his book<sup>2</sup>, he says that "colloid chemistry has been developed on the assumption that the ultimate unit in colloidal solutions is not the isolated molecule or ion but an aggregate of molecules or ions, the so-called micella of Naegeli. Since it seemed improbable that such aggregates could combine in stoichiometrical proportions with acids, alkalies, or salts, the conclusion was drawn that electrolytes were adsorbed on the surface of colloidal particles according to a purely empirical formula, Freundlich's adsorption formula."

This position was challenged at the time<sup>3</sup> in a review of the book. "From the reviewer's standpoint this brief paragraph contains at least three fundamental errors. Colloid chemistry has been developed on the assumption that colloid solutions are suspensions and not solutions. Of course the suspended particles are not isolated molecules; but that is absolutely a side issue. It is perhaps because of this initial error that Loeb fails to grasp the important

<sup>1</sup> "The Physical Chemistry of the Proteins" (1918).

<sup>2</sup> "Proteins and the Theory of Colloidal Behavior" (1922).

<sup>3</sup> "Bancroft: J. Phys. Chem., 26, 687 (1922).

difference between a solution and a suspension. Adsorption was not postulated because of the improbability of aggregates combining in stoichiometric proportions with acids, alkalies, or salts, and it was not deduced from the behavior of colloidal solutions. The idea of adsorption came from the fact that a second phase, charcoal, silica, etc., took material out of solution in a manner which did not correspond to stoichiometric relations. The application of this to adsorption in a colloidal solution, by proteins for instance, was a secondary step and again had nothing to do with any question of improbability. Loeb has overlooked the fact that solid calcium sulphate presumably does not consist of isolated molecules and yet will take up water in stoichiometric proportions. If one is not willing to accept water as typical, it would undoubtedly be a simple matter to find a sparingly soluble salt which would take another salt out of solution to form a double salt. Loeb is ascribing to the chemists emotions and beliefs which are quite foreign to them. It is also a mistake to lay stress on Freundlich's adsorption formula. The important point is that the concentrations in the solution and in the adsorbent vary continuously. Whether the change of concentrations can be expressed by any single formula is of no importance whatsoever. It is quite true that many articles are written in such a way as to imply that the quantitative agreement of the results with the formula is essential; but a man like Loeb cannot base his argument on carelessly expressed articles without throwing himself open to the charge of special pleading".

This criticism had no effect. The preface to the first edition was reprinted in the second edition of (1924). In order that there shall be no misunderstanding as to his position, Loeb<sup>1</sup> says in the text: "If the methods of measuring the hydrogen ion concentration of protein solutions had been introduced before the colloidal speculations had been developed, nobody would have thought that proteins do not combine stoichiometrically with acids and alkalies. Scientists would have realized from the first that since proteins are built from amino-acids, they should be expected to react with acid and alkalies in the same stoichiometrical way as do amino-acids or dipeptides. It is always a misfortune for the development of science if problems are taken up before the proper methods for their solution exist, because it is a part of human nature that the authors of premature speculations based upon faulty or inadequate methods try to defend their erroneous views, in preference to learning and applying the new methods".

Loeb did drop out in the second edition, p. 170, a paragraph which appeared in the first edition, p. 119: "As long as chemists continue to believe in the applicability of the adsorption formula to the behavior of proteins, no scientific theory of colloidal behavior will be possible. We intend to show in the second part of the book that such a theory can be given on the basis of the stoichiometrical proof that proteins form true salts with acids and alkalies, and that the salts lead to the formation of protein ions. Colloidal behavior is due to the fact that these protein ions cannot diffuse through

<sup>1</sup> 'Proteins and the Theory of Colloidal Behavior', 73 (1924).

many membranes, which are permeable to the majority of crystalloidal ions, or that protein ions form solid gels in which cohesive forces prevent their diffusion, while such gels are permeable to crystalloidal ions. The theory of the equilibrium conditions resulting from this difference in the diffusibility of the two opposite ions of an electrolyte was developed by Donnan. These equilibrium conditions give rise to forces such as potential difference, osmotic pressure, etc., which are the only cause of colloid behavior. It will be shown that Donnan's theory gives not only a qualitative but a quantitative and mathematical explanation of colloidal behavior."

In the second edition, p. 170, the preceding paragraph was apparently condensed to about four lines: "A mathematical and quantitative explanation of the influence of electrolytes on the colloidal behavior of protein solutions can be given on the basis of Donnan's equilibrium. The proof of this statement will be given in the second part of this book".

The same general viewpoint is still held by Wilson<sup>1</sup> and others. "The physical chemistry of the proteins is one of the foundations upon which leather chemistry is built, but, until comparatively recently, our knowledge of the chemical reactions of the protein was hardly sufficient to permit of quantitative treatment. Proteins did not seem to show the stoichiometrical relations of orthodox physical chemistry to earlier investigators because they failed to recognize the full number of phases<sup>2</sup> existing in a given system and the necessity for making measurements at definite hydrogen ion concentrations."

"The way for the quantitative development of the physical chemistry of the proteins was paved by the appearance of Donnan's theory<sup>3</sup> of membrane equilibria, which was applied by Procter<sup>4</sup> to the swelling of gelatin and further developed by Procter and Wilson<sup>5</sup> into a quantitative theory of the swelling of protein jellies."

"In an extensive series of researches, Loeb<sup>6</sup> has extended this work to include also the osmotic pressures, viscosity, stability, and electrical potential differences of protein solutions as well as a general theory of colloidal behavior.

"It will be shown in this chapter that proteins conform to the classical laws of physical chemistry and that their reactions are indicated by well-established principles. Donnan's theory forms the logical starting point for this presentation."

In the second edition the preceding paragraph was expanded and weakened.<sup>7</sup> "Because of the very great importance of the Donnan theory it will be discussed in this chapter in detail. It does not explain all of the important reactions of the proteins, but it is necessary to an understanding of certain

<sup>1</sup> "The Chemistry of Leather Manufacture", 94 (1923).

<sup>2</sup> [There is nothing to show what this means].

<sup>3</sup> Z. Elektrochemie, 17, 572 (1911).

<sup>4</sup> J. Chem. Soc. 105, 313 (1914).

<sup>5</sup> J. Chem. Soc. 109, 307 (1916).

<sup>6</sup> J. Gen. Physiol. (1918-1922).

<sup>7</sup> Wilson: "The Chemistry of Leather Manufacture", 129 (1928).



phenomena shown by the proteins. It has made possible quantitative explanations of the swelling of jellies, of variations in viscosity of gelatin dispersions, of the osmotic pressures developed by certain protein systems, of the electrical potential differences observed between the different phases in a protein system, and of the stability of certain dispersions. In the enthusiasm naturally aroused by the development of a theory so important, false impressions were spread as to the scope of the Donnan theory and chemists began to point out protein reactions that could not be explained by it. They showed that in many reactions different ions of the same valency had very different effects upon proteins, whereas there are no specific effects of ions of the same valency involved in the phenomena explained by the Donnan theory. The theory does not attempt to explain why the bromide ion is so much more effective in dispersing collagen than the chloride ion or any other reaction not clearly defined by the theory."

Wilson<sup>1</sup> points out that "Procter recognized that gelatin combines with hydrochloric acid forming a highly ionizable chloride and that the resulting equilibrium is a special case of the membrane equilibria described by Donnan. Instead of tracing the development of the theory of swelling from Procter's earliest work to its present status, it will simplify matters to present the theory from the deductive reasoning furnished later by Wilson and Wilson.<sup>2</sup> They set out to prove that the entire equilibria can be determined quantitatively on the simple assumption that gelatin, or any other protein, combines with hydrochloric acid to form a highly ionizable chloride. It seemed that success in this would furnish substantial proof of the theory."

Donnan<sup>3</sup> himself, has pointed out that the Donnan principle applies equally well to either chemical combination or adsorption. "Very many interesting investigations based on this simple theory have been made by Jacques Loeb and his collaborators. In this work, among other things, the effect of acids, alkalies, and salts on the osmotic pressures and membrane potentials of the amphoteric proteins have been studied. Loeb has shown that the simple theory of membrane equilibria is capable of accounting fairly quantitatively for a great many of his experimental results, and regards this as a proof that the phenomena exhibited by the protein ampholytes are due to simple chemical reactions and not to the adsorption of ions by colloid aggregates or micells. While this view may be correct in many instances, it is necessary to remember that the theory of membrane equilibria depends simply on two assumptions:

(a) The existence of equilibrium.

(b) The existence of certain constraints which restrict the free diffusion of one or more electrically charged or ionized constituents.

and that the equations hold equally well whether we have to deal with 'colloid units', which have acquired an ionic character (electrical charge) by

<sup>1</sup> "The Chemistry of Leather Manufacture", 136 (1928).

<sup>2</sup> J. Am. Chem. Soc., 40, 886 (1918).

<sup>3</sup> Chemical Reviews, 1, 87 (1924).

adsorption of ions, or with simple molecules which have been ionized by the loss or gain of electrons. All that is necessary for the theory is that the simple ionized molecules or the ionic micells be subject to the same constraint, namely inability to diffuse freely through the membrane."

The reason for the assumption of Wilson and Wilson cited above is to be found in the statement<sup>1</sup> that "proteins are amphoteric substances, reacting both as weak acids and as weak bases. In this respect they retain the properties of the amino acids from which they are formed."

It is not safe to push the analogy between the proteins and the constituent amino acids too far. Robertson<sup>2</sup> says: "Reverting to the purely chemical hypotheses which profess to interpret the neutralization of acids and bases by proteins, these are of two kinds. The earliest and simplest view and that which is still upheld by very many who have not yet encountered or devoted sufficient thought to the facts which render it untenable, is that the neutralization is accomplished exclusively by the terminal carboxyl and amino group of protein molecule. Thus it is common knowledge that the various amino acids are capable of neutralizing either acids or bases in apparent accordance with the equations:

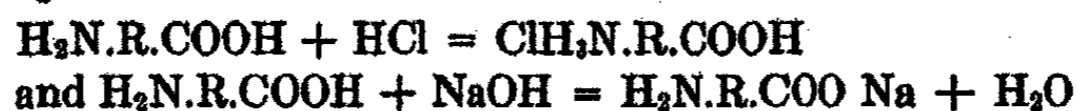

Now the proteins are generally regarded as polyamino acids built up, as Hofmeister<sup>1</sup> originally suggested, by a series of reactions of the type:



the resulting compound being still an amino acid. This theory is frequently considered to have been substantiated by the synthesis of the polypeptides by Emil Fischer,<sup>4</sup> since syntheses admit of representation by formulas of the above type, although, of course, the equations which represent a synthesis do not necessarily define the internal structure of the resultant molecule. The presence of the terminal amino and carboxyl groups in the molecule is thought to account for the amphoteric properties of the proteins, while the multiple combining capacities of proteins are referred to the presence of diamino or dicarboxyl radicals or of branches in the polyamino acid chain, leading to the presence of a number of terminal amino and carboxyl groups."

"To this view which is still held by very many, the author<sup>5</sup> also formerly inclined; but subsequent fuller<sup>6</sup> acquaintance with the quantitative aspects of the neutralization of acids and bases by proteins compelled its abandonment."

By the diazo reaction it has been shown that the following percentages of total nitrogen are present as free amino groups: hemoglobin, 6.0; casein, 5.5;

<sup>1</sup> Wilson: "The Chemistry of Leather Manufacture", 147 (1928).

<sup>2</sup> Alexander: "Colloid Chemistry", 256 (1928).

<sup>3</sup> Ergebnisse Physiol., 1, 787 (1902).

<sup>4</sup> "Untersuchungen über Aminosäuren, Polypeptide, und Proteine" (1899-1906).

<sup>5</sup> T. Brailsford Robertson: "The Proteins", Univ. of California Publ. in Physiology (1909)

<sup>6</sup> T. Brailsford Robertson: J. Phys. Chem., 15, 521 (1911).

hemocyanin, 4.3; gelatin, 3.1; edestin, 1.8; gliadin, 1.1; zein, 0.0; heteroalbuminose, 8.1; protoalbuminose, 9.9. Osborne finds that the amount of hydrochloric acid bound by edestin, if calculated to free amino groups corresponds roughly to five times as many amino groups as there are. With gelatin there should be three times as many amino groups as there are, if we adopt Hitchcock's estimate of 1120 as the combining weight of gelatin, and about twice as many if we take Procter and Wilson's figure of 768. Sturin neutralizes about eight times as much acid as can be accounted for by the free amino groups.<sup>1</sup>

"The number of carboxyl groups in any protein cannot be much in excess of the number of amino groups, for otherwise the proteins would be overwhelmingly acid in character and, besides, since relatively few of the amino acid radicals in most proteins are dicarboxylic acid radicals, if a great excess of free carboxyl groups were present in the molecule, the combined amino groups could not be attached to carboxyl groups, as they are in the polypeptides, and the splitting of proteins into their constituent amino acids by hydrolysis could not occur. As a rule, therefore, free carboxyl groups in proteins must be derived from dicarboxylic acids. Now gelatin according to the analysis of Dakin,<sup>2</sup> contains 0.907 percent of nitrogen in the form of the dicarboxylic acids, aspartic acid and glutamic acid. To neutralize the free carboxyls of these acids, assuming, in each case only one carboxyl binds the amino acid to the protein molecules, would require  $64.10^{-5}$  equivalents of base per gram of gelatin. This allows nothing for internal neutralization of dicarboxylic acids by diamino acids which, leaving lysine out of consideration, furnish 16 percent of the total nitrogen in gelatin, nor have we made allowance for the neutralization of 'amid' nitrogen in gelatin. Yet the actual neutralizing capacity of gelatin for bases, as Loeb<sup>3</sup> has shown equals or exceeds  $100 \times 15^{-5}$  equivalents of base per gram (at pH 11.5)."

The probable number of carboxyl groups in casein will only account for about half of the maximum amount of alkali fixed by casein or by fibrin.<sup>4</sup> "From all these results, and others of like nature which might be cited, we must certainly infer that the capacity of proteins to neutralize acids and bases cannot be attributed wholly to the terminal amino or carboxyl groups. We are unable, it is true, to state that these play no part whatever in the neutralization of acids and bases; on the contrary many proteins demonstrably possess free amino groups and these must doubtless exercise their basic function in the presence of sufficient excess of acid. We lack information concerning the existence or otherwise of free carboxyl groups in the protein molecule; but, if they are present, they, too, must doubtless contribute their share towards the total neutralizing capacity of the proteins in solutions which contain a sufficient excess of free base. But in each case the number of

<sup>1</sup> Robertson in Alexander: "Colloid Chemistry," 260 (1928).

<sup>2</sup> J. Biol. Chem., 44, 499 (1920).

<sup>3</sup> "Proteins and the Theory of Colloidal Behavior" (1922).

<sup>4</sup> Robertson in Alexander: "Colloid Chemistry", 263 (1928).

these groups is demonstrably insufficient to account for the total neutralizing capacity of the proteins.

"Since we cannot attribute the residual combining capacity of the proteins for bases to carboxyl groups, its origin at first sight seems difficult to perceive; but the investigations of Osborne and Leavenworth<sup>1</sup> enable us to assign its origin to COHN groups in the interior of the protein molecules. It has been shown by Kober<sup>2</sup> that the copper salts of amino acids in alkaline solution yield their copper quantitatively in the form of a precipitate of cupric hydrate on heating the solution or on addition of an excess of alkali. Under similar conditions the copper compounds of peptones and peptides yield little or no precipitate. Osborne and Leavenworth have shown that the maximum amount of cupric hydrate which edestin or gliadin will hold in solution corresponds exactly with the number of COHN groups in the molecules of these proteins, assuming that one atom of copper combines with each atom of nitrogen. In the case of the union of copper hydroxide with proteins, therefore, the combination is effected by means of the COHN groups within the body of the protein molecule, and the supposition may therefore be entertained that the combination of proteins with other bases is effected in a like manner."

"That the neutralization of acids may similarly be effected by -COHN-groups is shown by the observations of Siegfried<sup>3</sup> upon the barium salts of carbamino acids which are formed when carbon dioxide is passed into solution of amino acids in dilute barium hydroxide. Direct analysis of the products obtained when barium carbonate or calcium carbonate act upon glycocoll and other amino acids showed that these compounds can be represented by the general formula:

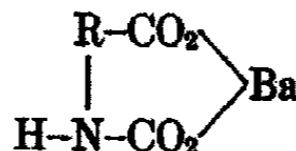

being the barium or calcium salts of carbamino acids. On standing, barium carbonate or calcium carbonate, as the case may be, is liberated slowly, and this process is accelerated by heating."

Loeb<sup>4</sup> knew that the number of free amino groups did not correspond with the number of molecules of hydrochloric acid fixed, though he did not stress the fact as Robertson does. Wilson<sup>5</sup> also knows it but uses the facts to emphasize a different view-point.

"Hitchcock prepared deaminized gelatin without heating and found the product to contain less nitrogen than the original gelatin by an amount equal to 0.00040 gram equivalents per gram of protein. He then proceeded to

<sup>1</sup> J. Biol. Chem., 28, 109 (1916).

<sup>2</sup> J. Biol. Chem., 10, 9 (1911); 13, 1 (1912); Am. Chem. J., 48, 383 (1912); J. Am. Chem. Soc., 35, 1546 (1913).

<sup>3</sup> Ergebnisse Physiol., 9, 334 (1910).

<sup>4</sup> "Proteins and the Theory of Colloidal Behavior."

<sup>5</sup> "The Chemistry of Leather Manufacture," 143 (1928).

measure the acid-binding power of the deaminized gelatin as he had for the original gelatin by the method just described. The maximum combining capacity of gelatin for HCl was found to be 0.00089 gram equivalents per gram of gelatin and of deaminized gelatin only 0.00044 gram equivalents. The difference between the maximum combining capacities, 0.00045, is practically the same as the loss in nitrogen occurring in the deaminizing reaction. Since any error that may be involved in the determination of acid-combining capacities is present in both determinations, it is at least partly removed in the subtraction, making the difference correspondingly more accurate. Apparently for each atom of nitrogen lost in the deaminizing reaction, the protein loses the capacity to combine with one hydrogen ion. This constitutes a strong confirmation of the theory that the combination of protein with acid is chemical combination. The combining capacity for HCl still retained by deaminized gelatin is presumably to be ascribed to the NH groups which are not attacked by the nitrous acid."

Robertson<sup>1</sup> finds these results "somewhat surprising": "Shortly after the author first advanced the view that a considerable portion of the combining capacity of proteins for acids is not attributable to free amino groups,<sup>2</sup> Blasel and Matula<sup>3</sup> investigated the acid-binding capacity of deaminized gelatin: their results indicated that gelatin which has been deaminized by treatment with nitrous acid retains to the full the acid-combining capacity of untreated gelatin; a result which was somewhat surprising, since it could hardly have been expected that the terminal amino groups which are known to be present in gelatin would play no part whatever in determining its maximal combining capacity. Hitchcock, however, employing an improved method of deaminization, finds that the maximal combining capacity of gelatin for acids is reduced to one-half by deaminization and that the loss of combining capacity is exactly equivalent to the amino groups which have been destroyed,<sup>4</sup> a result which, again, is somewhat surprising because one would have expected the loss of combining capacity to be considerably less than equivalent to the loss of amino groups, on account of the hydrolytic dissociation which the compounds of these amino groups with acids might be expected to undergo, even in solution, which contain an excess of acid. Thus, according to Hitchcock, the maximum combining capacity of gelatin is attained at pH 1.8, whereas lysine dichloride is 30 percent dissociated at this pH even in twentieth molecular concentration and must be considerably more dissociated in 1/250th molecular concentration (one percent gelatin) even if the pH is maintained unaltered. It is impossible at present, however, to be sure that no changes other than deaminization are brought about in proteins by treatment with nitrous acid in acid solution and quantitative comparisons of this kind are therefore subject to this measure of uncertainty."

<sup>1</sup> Robertson in Alexander: "Colloid Chemistry", 269 (1928).

<sup>2</sup> Robertson: "Die physikalische Chemie der Proteine" (1912).

<sup>3</sup> Biochem. Z., 38, 417 (1914).

<sup>4</sup> J. Gen. Physiol., 6, 95 (1923).

If these measurements are accurate, the equivalence of the decrease in amino groups and in acid-combining power can, of course, be accounted for most simply by assuming chemical combination, as Wilson has done. This is not the only possible hypothesis, however. Localized adsorption by the  $\text{NH}_2$  group with a maximum of one  $\text{HCl}$  would give the same result. It probably seems the height of foolishness to postulate the formation of para-toluidine hydrochloride as being possibly the maximum composition of an adsorption complex, instead of being a definite chemical compound; but one could differentiate between the two. If a definite chemical compound were formed, we should have two solid phases so long as there exists some free para-toluidine, and consequently a constant pressure so long as the temperature is kept constant. With an adsorption complex the pressure will rise gradually and the system will behave as though there were only one solid phase. Also, the compound may still exist in solution, whereas, the adsorption complex cannot, so far as we now know. That is why the question whether gelatin is in true solution or not is so important.

A compromise viewpoint which has recently been proposed by Gortner<sup>1</sup> is that both chemical combination and adsorption occur when an acid or a base is bound by a protein. In his belief stoichiometrical combination holds for the hydrogen ion concentrations between pH 2.5 and pH 10.5, while combination takes place by adsorption at all other hydrogen ion concentrations. Gortner's results are not conclusive. Many of his curves might just as well have been used to prove that adsorption was taking place over the entire range of hydrogen ion concentrations. There is no theoretical reason why the initial adsorption cannot be practically 100 percent. The article has already been discussed in a criticism from Bancroft.<sup>2</sup> "Gortner's results are very important; but they are presented in such a curious way that they are not convincing. Gortner does not plot acid or base taken up against final concentration of acid or base which he should do. He does not draw any curves to show what the values would be in case of no adsorption. He works with one gram per 100 cc which seems inadequate. He assumes that there is no protein error and he apparently ignores hydrolysis."

We have, then, three viewpoints. Robertson, Loeb, and others claim that all proteins form true solutions in water and that they combine with acids and bases in stoichiometrical proportions. Some colloid chemists dispute both contentions as general statements and specifically for gelatin and casein, while Gortner and a large number of others believe that both chemical combination and adsorption occur but are unwilling to state whether or not the "caseinate" ion is in true solution or in suspension.

Everybody admits that carbon black does not form true solutions with water and that sugar and sodium chloride do; but there is no agreement as to where to draw the line even qualitatively between a true solution and a suspension or emulsion. Loeb and his followers have always refused to give

<sup>1</sup> Colloid Symposium Monograph (1925).

<sup>2</sup> J. Phys. Chem., 29, 1482 (1925).

any criterion of what constitutes a true solution or suspension; but they are quite sure that the alleged gelatin hydrochloride and sodium gelatinate are on the true-solution side of the undrawn line. On the other side we have the definite formulation<sup>1</sup> that any substance which can be removed by filtration through an ultra-filter—not a semipermeable membrane—is suspended and not in true solution. The converse is not necessarily true, because we may make better ultra-filters in the future. Under this definition, gelatin and casein are not in true solution because they can be filtered out easily. It is probable that the true solubility of gelatin in water is not more than one gram per liter. Since no agreement can be reached on this point at present, the next question is whether all proteins combine with acids and bases in stoichiometrical proportions.

In the review of the first edition of Loeb's book is the statement<sup>2</sup> that "the reviewer would have been interested in some phase rule proof of the existence of gelatin hydrochloride for instance. If the chemistry of protein solutions is merely the orthodox chemistry of hydrolyzed salts, it is a pity not to have shown the existence of these salts by the orthodox methods, merely as a guarantee of good faith."

Neither Loeb or any of his followers has given any phase rule proof of the existence or non-existence of the compounds of the proteins with acids or bases.

It is a comparatively simple matter to tell whether an acid or base as a dye is adsorbed by charcoal, sand, silk, wool, cotton, paper, rayon, or celanese. One can treat the solid with solutions of varying concentrations and determine the nature of the curve when the amount taken up is plotted against the final concentration in the solution. If a smooth curve is obtained, it means that there is apparently only one solid phase, whereas a flat indicates two solid phases.<sup>3</sup> This can be done, because the solid phase does not go into true solution and can be analyzed with some degree of accuracy. This cannot be done with the proteins, because they go into apparent solution in the presence of acids or bases. It is difficult to separate and analyze the two phases and the school of Robertson and Loeb denies that there are two phases, preferring to believe that the protein has gone into true solution.

It seemed desirable therefore to eliminate the solution phase and to treat the powdered protein with ammonia or hydrogen chloride gas, noting the amounts taken up at equilibrium and the corresponding pressures. If there is a solid ammonium caseinate or ammonium gelatinate, the pressure must remain constant until all the protein has been converted into the ammonium compound. If ammonia is adsorbed by the protein, there will be a smooth curve characteristic of adsorption.

Applying the phase rule,  $F = C - p + 2$ , to this system of protein and vapor; it is apparent that when we have three phases (protein, ammonium proteinate,

<sup>1</sup> Bancroft: *J. Phys. Chem.*, 29, 966 (1925).

<sup>2</sup> Bancroft: *J. Phys. Chem.* 26, 692 (1922).

<sup>3</sup> Bancroft: "The Phase Rule", 59 (1897).

ammonia) there is one degree of freedom. Since the experiments are carried out at constant temperature that degree of freedom is removed and the system becomes invariant. In other words the pressure must remain constant irrespective of the amount of the gaseous component in the two solid phases, i.e. until all the protein has been converted into the compound. When this has happened, we have only two phases present and two degrees of freedom so that the pressure is free to change even though the temperature is kept constant. If adsorption of the gas by the protein takes place, then, since the system consists of only two phases, it is bivariant. At constant temperature, therefore, the pressure will vary continuously with the concentration of the gas in the solid phase.

While this method of treating a solid with a gas or vapor and noting the pressure changes at constant temperature, has been used for years, for water of crystallization,<sup>1</sup> for ammonia of crystallization,<sup>2</sup> for oxides,<sup>3</sup> and in other cases, it seems not to have been used systematically for the neutralization of acids and bases by ammonia and hydrogen chloride. When a preliminary report of Tsunajima's experiments on casein was made at the Detroit meeting of the American Chemical Society, many of the members present felt that the method had not been tested sufficiently in known cases to warrant the acceptance of the evidence that ammonia is adsorbed by casein and does not form a definite chemical compound according to stoichiometric relations. Although Tsunajima's experiments were conclusive that ammonium caseinate and casein did not occur at any time as two solid phases, there was a general feeling that perhaps the amino acids might be abnormal in some way.

Since the phase rule is general, of course this could not be so. On the other hand, it seemed simpler to get the data in question than to try to convince people that the data were unnecessary.

## II. Experimental Study

### 1. Introduction.

A weighed amount of powdered base or acid is placed in a vessel of known volume, and a known amount of hydrogen chloride or ammonia is run in. From the pressure at equilibrium the volume of gas remaining in the flask is calculated and the volume removed by the solid found by difference. Since the temperature is kept constant, there can be only one pressure when we have two solids and vapor. A flat in the pressure curve followed by a theoretically perpendicular branch means a compound having the composition represented by the reading on the abscissas of the point at which the nearly vertical branch of the curve starts.

Under the circumstances, it is quite immaterial whether our substance is pure or not, provided all we wish to determine is whether we are forming chemical compounds or adsorption complexes. Suppose that what we called

<sup>1</sup> Lescoeur: *Am. Chim. Phys.*, (6) 19, 35, 533 (1890).

<sup>2</sup> Browne and Houlehan: *J. Am. Chem. Soc.*, 35, 649 (1913).

<sup>3</sup> Meyer and Rötgers: *Z. anorg. Chem.*, 57, 104 (1908).



gelatin was really a mixture of ten different acids—or more. There would be ten—or more—flats with a nearly perpendicular rise after the last one. If the ten or more flats are bunched within 5 mm. they will not mislead anybody into thinking that the steps constitute a curved ramp.

Suppose we start with a dibasic acid, tartaric or succinic acid for instance. On adding ammonia at constant temperature we shall get a constant pressure, the dissociation pressure of the acid ammonium salt, until the whole of the free acid has been converted into the acid ammonium salt. The pressure will then rise until the neutral ammonium salt begins to be formed, after which the pressure will remain constant until the whole of the acid ammonium salt is converted into the neutral ammonium salt. Theoretically then, there will be two flats in the curve and this has been realized at room temperature with tartaric acid.

If the two dissociation pressures differ by less than the experimental error, there will be one long flat covering the whole range from the free acid to the neutral ammonium salt. The only way one would recognize such a dibasic acid would be by the amount of ammonia taken up. This case has been realized experimentally with succinic acid. At higher temperatures it is possible to increase the difference between the two dissociation pressures and to make succinic acid behave like tartaric acid. This has been done at  $107^{\circ}$ .

The other extreme would be that the dissociation pressure of the neutral ammonium salt exceeds the highest pressure obtainable under the conditions of the experiment, say atmospheric pressure. In that case there will be only one flat and only the acid ammonium salt will be formed. This case has been realized experimentally with glutamic acid, which is a dibasic acid, so far as its formula goes; but which forms only an acid ammonium glutamate under the conditions of the experiment.

Suppose we have a mixture of two monobasic acids in any proportions one pleases, known or unknown, and let us suppose that the dissociation pressure of the ammonium salt of acid A is 3 mm. of mercury, and that of the ammonium salt of acid B is 5 mm. of mercury. On adding ammonia at constant temperature to the mixture of acids we shall get a flat at 3 mm. until the whole of acid A has been converted into its ammonium salt, and then a flat at 5 mm. until the whole of acid B has been converted into its ammonium salt. If the difference between 3 and 5 mm. is outside the limits of experimental error, we shall have two flats, we can recognize the presence of two acids, and we can determine the amount of each. If the difference between 3 and 5 mm. is within the limits of experimental error, as it usually will be, there will be apparently only one flat and one cannot tell either that there are two acids or how much there is of each. One can, however, determine the number of formula weights of the mixed acids. This case has been realized experimentally with para-aminobenzoic acid and aminosulphonic acid.

If the dissociation pressure of the ammonium salt of one of the acids is greater than that in use in the experiments, that compound will not form and the presence of that acid in the mixture will not appear. Since amino acetic does not form a compound with ammonia, a mixture of para-aminobenzoic

acid and amino acetic acid will behave as though only the para-aminobenzoic acid were present. This is so obvious that the experiment was not tried.

The presence of moisture in the acid or base merely displaces the curve without changing its general nature. If we add ammonia to a saturated solution of oxalic acid, for instance, there will be no flat until the solution is saturated with respect both to oxalic acid and ammonium oxalate. The pressure measured along the flat will be the dissociation pressure of the acid ammonium oxalate plus the partial pressure of the water vapor in equilibrium with the saturated solution. The essential thing is that there is a flat in the curve. The ammonia composition at which the flat ends is no longer the composition of the compound. It is the amount of ammonia in the compound plus that in the solution at which there is no longer any oxalic acid as a solid phase. This, of course, will vary with the relative amounts of water vapor and oxalic acid; but it will not affect the conclusions to be drawn from the diagram. This is important because the believers in ammonium gelatinate would undoubtedly have raised the point, which is well taken, that drying gelatin changes it completely. The presence of varying amounts of water vapor in gelatin does not in any way enter into the proof that ammonium gelatinate is not formed at ordinary temperatures.

The experimental work which will be introduced in this paper may, then, be summarized as follows:

1. It will be shown that the phase rule method is suitable for determining the nature of combination occurring between a solid and a gas.
2. Small amounts of impurities in the solid will not affect the general nature of the curves obtained.
3. In the presence of small amounts of water vapor a compound may be detected practically as sharply as with the dry solid. Furthermore equilibrium is reached more quickly.
4. After establishing the above points, evidence will be offered concerning the type of combination existing between proteins and ammonia or hydrogen chloride.

## 2. Apparatus.

The apparatus is as shown in the accompanying diagram. A weighed sample of the solid acid or base is placed in the reaction vessel 2. The entire system is then evacuated. A known volume of dried HCl or NH<sub>3</sub> is run in from the Hempel burette, stopcock A being closed. The system is allowed to stand until the pressure as indicated on the manometer becomes constant. The reaction flask is calibrated so that for any pressure the volume of vapor remaining in the flask may be read from a curve. The difference between the volume of gas added and that left in the flask at equilibrium gives the volume taken up and from this the weight of HCl or NH<sub>3</sub> removed by the solid may be calculated. This procedure is repeated until the entire curve has been obtained, the pressures at equilibrium being plotted as ordinates,

the weights of the gas taken up by one gram of the solid as abscissas. Flask 1 is calibrated in the same manner as the reaction vessel: it is a one-liter flask, introduced merely to increase the volume of the system and thus facilitate work at low pressures. In the case of experiments performed in the presence of added water, water as vapor was introduced through the stopcock D.

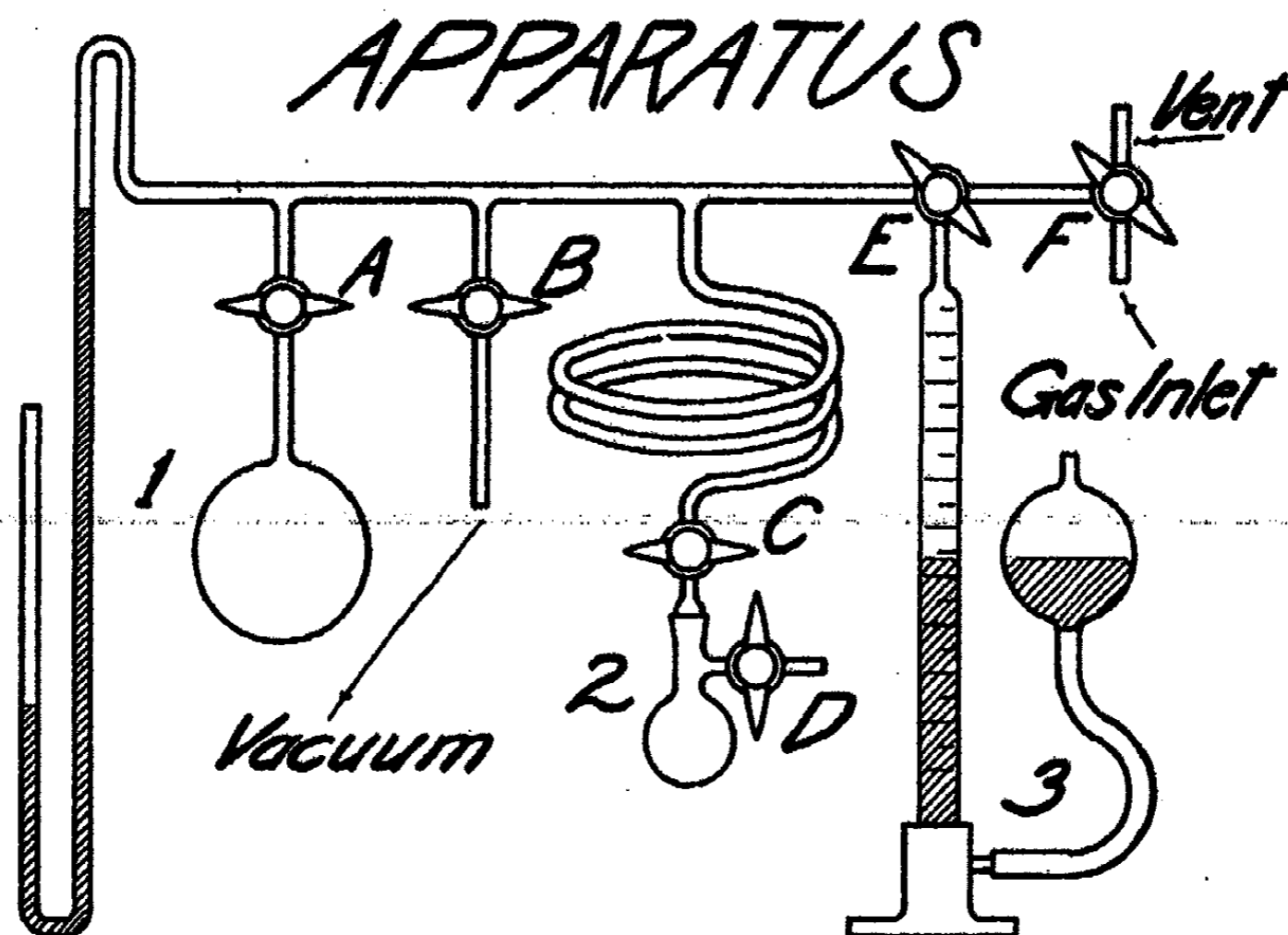

### 3. Experimental Results.

1. Table I gives the data for stearic acid and Fig. 1 shows the curve obtained by plotting milligrams of ammonia taken up by one gram of stearic acid (abscissa) against the equilibrium pressure expressed in millimeters.

For the formation of ammonium stearate one gram of stearic acid would require 59.8 milligrams of ammonia. The end of the flat in this curve comes at about 61.0 milligrams of ammonia per gram of stearic acid. The error between the calculated results and those found is about two percent.

2. In Table II we have the data for succinic acid and ammonia. At room temperatures it is impossible to detect the difference between the first and second mols of ammonia added to succinic acid. At about 80° some difference is evident, while at 107° the decomposition pressure of the ammonium succinate is twenty millimeters and that of the acid ammonium succinate has remained constant at two millimeters. These data are shown in Fig. 2.

One gram of succinic acid should take up 288 milligrams of ammonia for the formation of the neutral ammonium succinate. In the experiment at room temperature the end of the flat in the curve is at 270 mg. of ammonia, an error of 6.25 per cent, while in the experiment at 107° the rise begins at 293 mg. of ammonia per gram of acid, an error of 1.7 per cent.

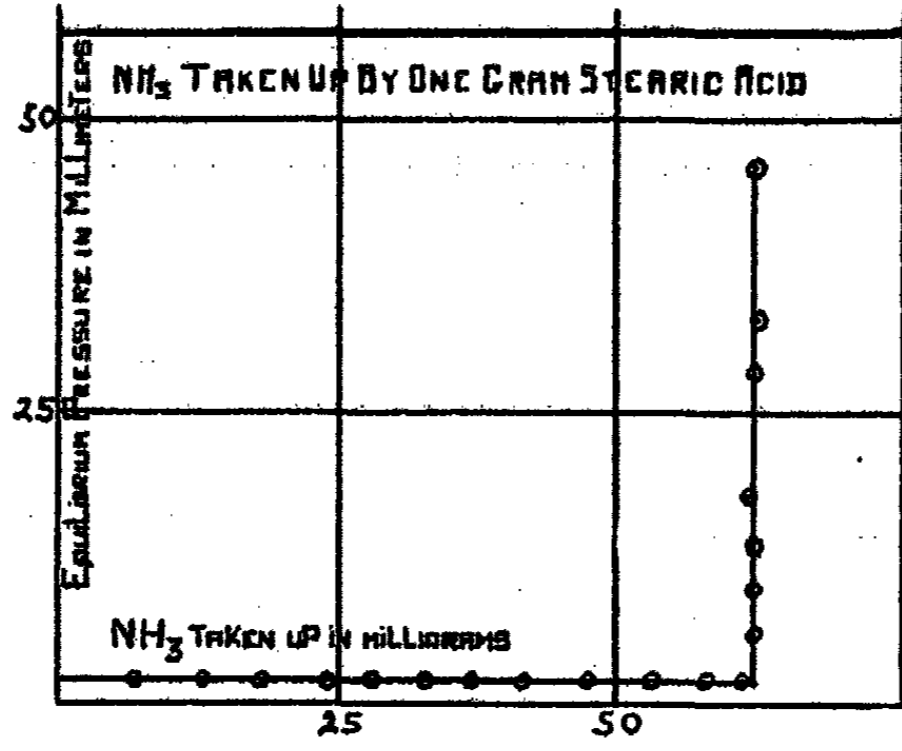

FIG. 1

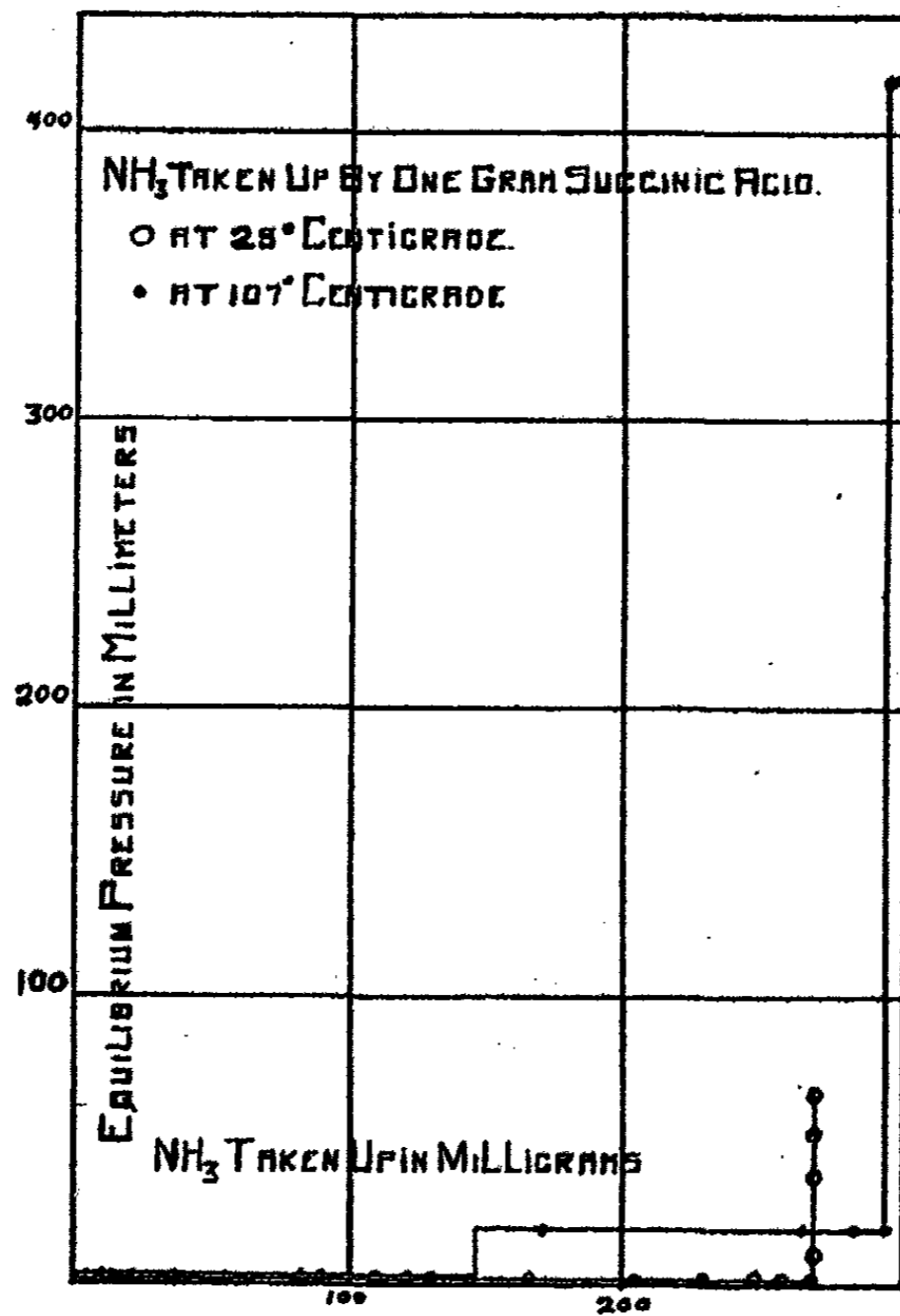

FIG. 2

TABLE I  
Stearic Acid and Ammonia

	Vol. NH <sub>3</sub> added cc	Vol. NH <sub>3</sub> removed cc	Total Vol. Std. Cond. cc	P <sub>2</sub> mm.	Volume remaining cc	Volume taken up cc	Vol. taken up per gm. cc	Wt. taken up per gm. mgm.
1.	26		26	2.0	0.7	25.3	8.4	6.5
2.	25.5		51.5	1.8	.7	50.8	16.9	13.0
3.	20.0		71.5	2.2	.8	70.7	23.5	18.1
4.	22.3		93.8	2.0	.6	93.2	31.1	24.0
5.	16.7		110.5	2.1	.7	109.8	36.6	28.2
6.	18.2		128.7	1.8	.6	128.1	42.7	32.9
7.	14.6		143.3	2.0	.6	142.7	47.6	36.7
8.	20.2		163.5	2.0	.6	162.9	54.3	41.8
9.	22.4		185.9	2.3	.6	185.3	61.8	47.6
10.	20.6		206.5	2.1	.7	205.8	68.9	53.1
11.	20.1		226.6	2.2	.7	225.9	75.3	58.0
12.	10.2		236.8	2.2	.7	236.1	78.7	60.7
13.	10.5		247.3	13.7	5.0	242.3	80.8	62.2
14.	6.3		253.6	28.5	10.4	242.6	80.8	62.2
15.	7.2		260.8	46.0	16.4	244.0	81.0	62.4
16.		4.5	256.3	33.0	12.0	244.3	81.4	62.6
17.		9.0	247.3	18.0	7.2	240.1	80.0	61.6
18.		2.9	244.4	10.0	3.6	240.8	80.2	61.8
19.		1.5	242.9	6.0	2.2	240.7	80.2	61.8
20.								

TABLE II

Succinic Acid and Ammonia

	Total volume NH <sub>3</sub> added cc	Volume removed cc	P <sub>2</sub> mm.	Total vol. taken up cc	Weight taken up per gram mgm.
1	10.8		2	10.8	5.0
2	21		2	21	2.5
3	30		2	30	14
4	47		2	47	21
5	79		2	79	36
6	125		2	125	56
7	180		2	180	82
8	196		2	196	89
9	244		2	244	110
10	267		2	267	121
11	286		2	286	130
12	365		2	365	166
13	452		2	452	205
14	504		2	504	230
15	545		2	545	247
16	566		2	566	257

TABLE II (Continued)

Succinic Acid and Ammonia				
Total volume NH <sub>3</sub> added cc	Volume removed cc	P <sub>2</sub> mm.	Total vol. taken up cc	Weight taken up per gram mgm.
17 614		53	593	269
18 620		67	594	269
19 609	10.8	38	593	269
20 605	3.5	28	593	269
21 598	7.0	10	594	269
22 594	4.0	2	592	268

## Succinic Acid and Ammonia

107°C

Vol. NH <sub>3</sub> added	Volume removed	Net volume	P <sub>2</sub>	Volume remaining	Volume taken up	Wt. taken up in mgms.	Wt. taken mgms. per gm. acid
995		995	2	1.5	994	767	113
900		1895	20	4.0	1891	1460	172
411		2306	20	4.0	2302	1770	265
160		2466	20	4.0	2462	1900	283
246		2712	418	125	2587	1994	293
	80	2632	80	47	2585	1994	293
	20	2612	20	4	2608	2010	300
	4	2608	20	4	2604	2007	299

In Fig. 3 are given curves for the data found in Table III for two experiments on tartaric acid with ammonia. In the case of this acid the difference in the decomposition pressures of the neutral ammonium tartrate and the acid ammonium tartrate is detectable at room temperature. For the curve marked by the triangles, water vapor was added to a pressure of twenty mm. before starting the experiment. This obscures the transition from the acid ammonium tartrate to the neutral salt; but the break in the curve at the completion of the formation of the neutral ammonium tartrate is almost as sharp as with the dry acid. Furthermore, equilibrium is reached more quickly in the presence of water vapor.

The theoretical amount of ammonia in one gram of the neutral ammonium tartrate is 226.7 mg. In the experiment in absence of any added water vapor, we find that the break in the curve corresponds to 229 mg. of ammonia, an error of 1.0 per cent. This was not calculated for the experiment in which water vapor was added since some of the ammonia must be taken up by the water vapor.

When we plot as abscissas, mols of ammonia taken up per mol of acid as in Fig. 4, the two dibasic acids, tartaric and succinic, come practically together and the stearic acid appears as a monobasic acid.

4. In Table IV are the data for aniline and hydrogen chloride. These are plotted in Fig. 5. Aniline is a liquid with a negligible vapor pressure

under the conditions of the experiment. As soon as aniline hydrochloride begins to crystallize we have three phases, solid aniline hydrochloride, liquid aniline, and vapor. Consequently the pressure must remain constant, so long as the temperature does, until all of the aniline is converted to the hydro-

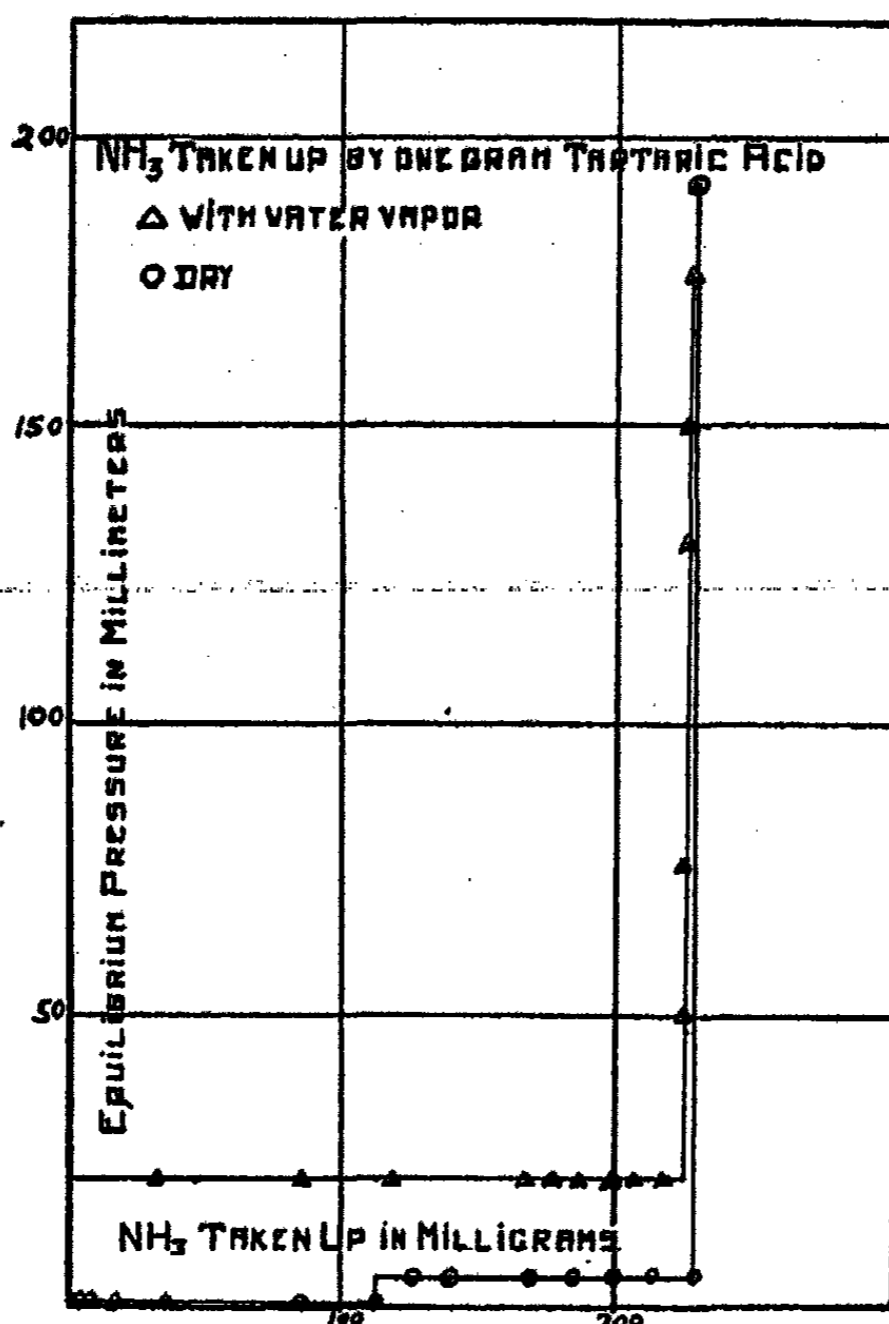

FIG. 3

chloride. The break comes at 377 mg. of HCl per gram of aniline as against a theoretical value of 392 mg. of hydrogen chloride. The error is 3.8 per cent and impurities in the aniline could easily account for it.

In Table V we have the data for two experiments with tribromaniline and one with benzoquinone. Both these compounds form hydrochlorides by taking up one mol of hydrogen chloride under the conditions of the experiment. These data are plotted in Figs. 6 and 7; the circles are for the tribromaniline dry, the triangles give the curve for the same compound when water vapor is added. Benzoquinone reacts very rapidly while the tribromaniline is very slow to react with hydrogen chloride; in fact there was some question as to whether this compound would form a hydrochloride at all or not under these conditions. The compound is very unstable, giving up hydrogen chloride when allowed to stand in the air or in water. Tribrom-

TABLE III  
Tartaric Acid and Ammonia  
Sample = 5.4 gms. Aq. V.P. = 20 mm.

	Vol. NH <sub>3</sub> added cc	Vol. NH <sub>3</sub> removed cc	Net volume cc	P <sub>2</sub> mm.	Vol. NH <sub>3</sub> remaining cc	Vol. NH <sub>3</sub> taken up cc	Wt. NH <sub>3</sub> taken up by 5.4 gms acid mgm.	Wt. NH <sub>3</sub> taken up per gm. acid mgm.
1	256.8		228.5	22	1	227.5	175	32.4
2	420.2		602.9	27	2.5	600	463	85.7
3	263		837.2	22	1	836	645	119
4	361.7		1163.0	24	2	1161	895	168
5	90		1244.0	30	5	1239	955	177
6	87.4		1322	45	12	1310	1010	187
7	94		1407	54	15	1392	1073	199
8	89.6		1487	95	35	1452	1120	207
9	95		1571	122	42	1529	1179	218
10	88		1650	232	87	1562	1205	223
11	96		1734	293	112	1622	1250	231
12	98		1820	461	182	1638	1263	234
13	92		1900	612	245	1655	1275	236
14	93		1982	771	312	1655	1275	236
15		136	1861	544	250	1611	1240	230
16		101	1771	367	157	1614	1244	230
17		67	1711	252	105	1606	1238	229
18		44	1672	177	72	1600	1233	228
19		16	1658	151	67	1591	1225	227
20		13	1645	131	55	1590	1225	227
21		32	1613	77	32	1581	1219	225
22		19	1594	50	22	1572	1214	225
23		52	1547	10	4	1543	1189	220

TABLE III (Continued)  
Tartaric Acid and Ammonia  
Sample = 4.59 gms. Dry

	Vol. NH <sub>3</sub> (Total) added cc	Vol. NH <sub>3</sub> removed cc	P <sub>2</sub> mm.	Vol. NH <sub>3</sub> remaining cc	Vol. NH <sub>3</sub> taken up cc	Wt. NH <sub>3</sub> taken up mgm.	Wt. NH <sub>3</sub> taken up per gm. mgm.
1	22		—	—	22	17	3.8
2	49		—	—	49	38	8.4
3	102		—	—	102	78	17
4	329	130	—	—	199	153	35
5	199		—	—	199	153	35
6	492		—	—	492	379	85
7	663		—	—	663	511	113
8	742		5	2	740	570	127



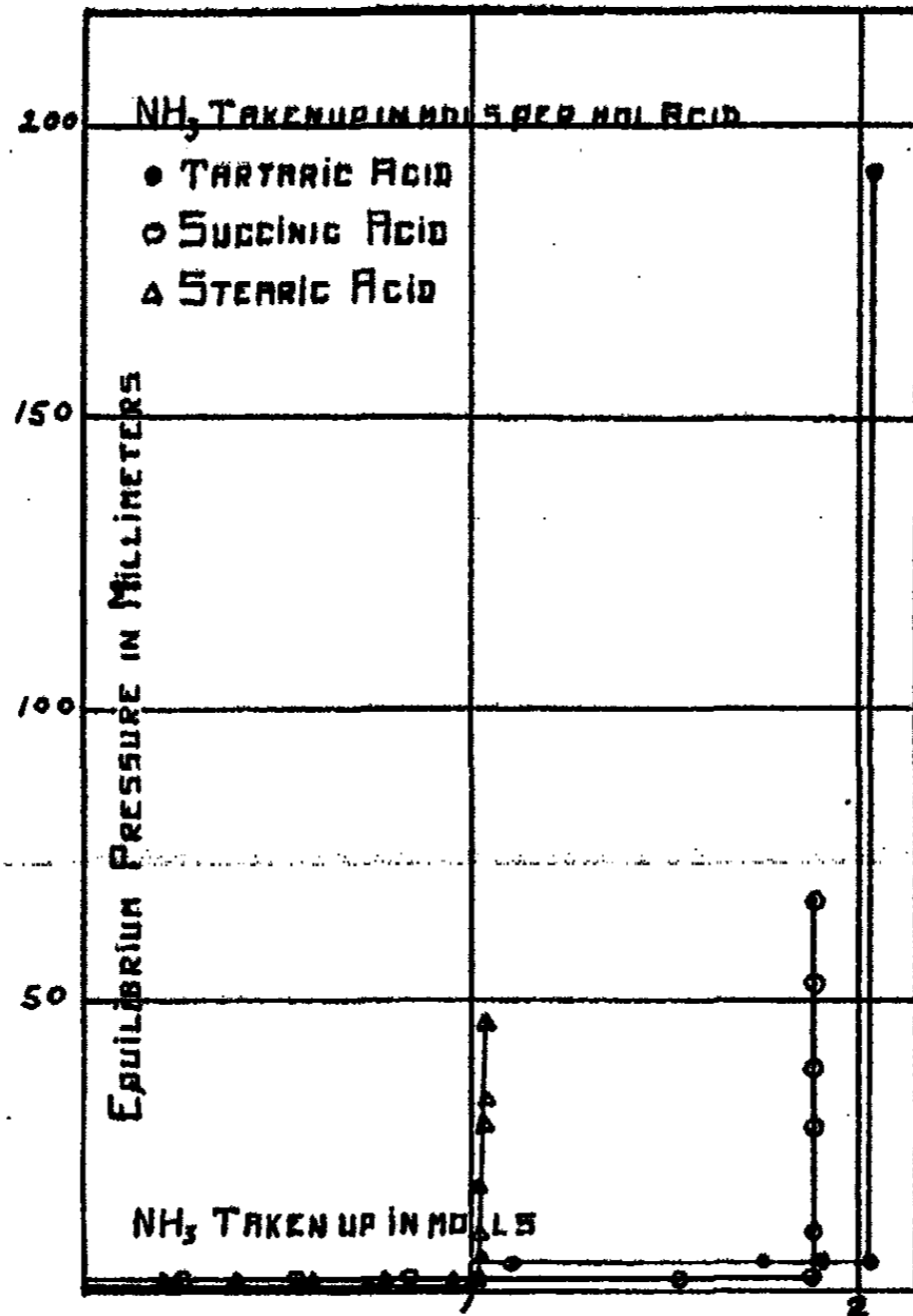

FIG. 4

TABLE III (Continued)  
Tartaric Acid and Ammonia  
Sample = 4.59 gms. Dry

	Vol. NH <sub>3</sub> (Total) added cc.	Vol. NH <sub>3</sub> removed cc.	P <sub>2</sub> mm.	Vol. NH <sub>3</sub> remain- ing cc.	Vol. NH <sub>3</sub> taken up cc.	Wt. NH <sub>3</sub> taken up mgm.	Wt. NH <sub>3</sub> taken up per gm. mgm.
9	831		5	2	829	639	142
10	996		6	2	994	766	170
11	1081		5	2	1079	832	185
12	1167		5	2	1165	898	199
13	1251		5	2	1249	963	214
14	1337		5	2	1335	1029	229
15	1419		192	80	1339	1032	230
16	1527		442	185	1342	1034	230
17	1623		670	277	1346	1037	231

TABLE IV  
Aniline and Hydrogen Chloride  
Sample = 5.0 gms.

Vol. HCl HCl added cc	Total volume cc	P <sub>2</sub> cc	Volume remaining cc	Volume taken up mgm.	Wt. HCl taken up mgm.	Wt. HCl taken up per gm. mgm.
52	52	2.5		52	85	17
48	100	2.5		100	164	33
55	155	2.5		155	254	51
51	206	2.5		206	338	68
42	248	2.5		248	406	81
53	301	2.5		301	493	99
44	345	2.5		345	566	113
30	375	2.5		375	615	123
19	394	2.5		394	646	129
17	411	2.5		411	674	135
28	439	2.5		439	720	144
93	532	2.5		532	872	174
14	546	2.5		546	895	179
19	565	2.5		565	926	185
30	595	2.5		595	975	195
29	624	2.5		624	1023	205
66	690	2.5		690	1131	226
27	717	2.5		717	1175	235
100	817	2.5		817	1339	268
32	849	3.0		849	1359	272
31	880	3.0		880	1442	289
30	910	3.0		910	1492	298
35	945	2.5		945	1549	310
38	983	3.0		983	1611	322
33	1016	3.0		1016	1665	333
25	1041	3.0		1041	1706	341
25	1066	3.0		1066	1747	349
8	1074	3.0		1074	1758	351
38	1112	3.0		1112	1822	364
44	1156	20	8.0	1148	1881	376
48	1203	120	52	1151	1886	377
34	1237	198	86	1151	1886	377
19	1256	248	106	1150	1886	377

aniline hydrochloride was prepared by Gattermann.<sup>1</sup> He dissolved tribromaniline in benzol and on adding hydrochloric acid the hydrochloride precipitated in small white needles. The results of his analysis gave 10.07 per cent for hydrochloric acid against a theoretical of 9.96 per cent and 89.95 per cent for tribromaniline against a theoretical of 90.04 per cent.

<sup>1</sup> Gattermann: Ber., 16, 634 (1883).

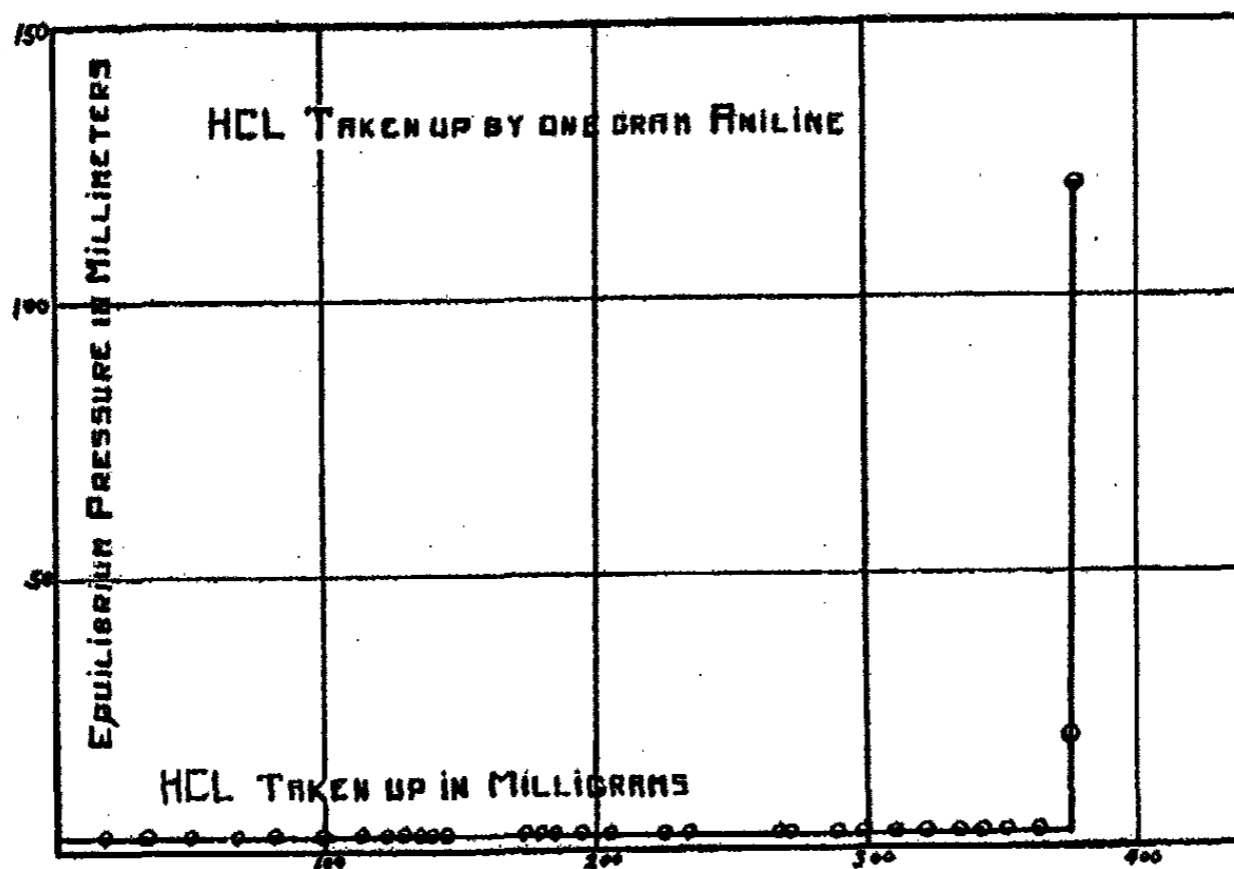

FIG. 5

TABLE V  
Tribromaniline and Hydrogen Chloride

Sample = 1.3 gms. Dry							
Volume HCl added cc	Volume HCl removed cc	Net volume cc	P <sub>2</sub> mm	Volume remaining cc	Volume taken up cc	Wt. HCl taken up mgm	Wt. HCl taken up per gm mgm
346	47	346	518	216	130	213	104
	47	300	424	178	122	200	154
	40	260	341	143	117	192	148
	33	227	274	115	112	184	141
	27	200	220	92	108	177	136
	84	116	59	25	91	149	115
	20	96	14	5	91	149	115
	6	90	4	1	89	146	112
Sample = 4.9 gms. Aq. V.P. = 19 mm.							
582		582	438	175	407	667	152
	174	408	121	50	358	587	133
	48	360	33	12	348	570	130
	20	340	14	6	334	547	124
	14	326	10	5	321	526	120
	14	312	10	5	307	509	114

## Benzoquinone-Hydrogen Chloride

Sample = 1.7 gms.

163	163	3	1	162	266	156
250	413	453	93	320	525	309
	84	329	0	—	329	539
86		415	413	85	330	541
68		483	736	150	333	546
	128	355	120	36	319	511
	30	325	28	6	319	511
	4	321	5	1	320	524

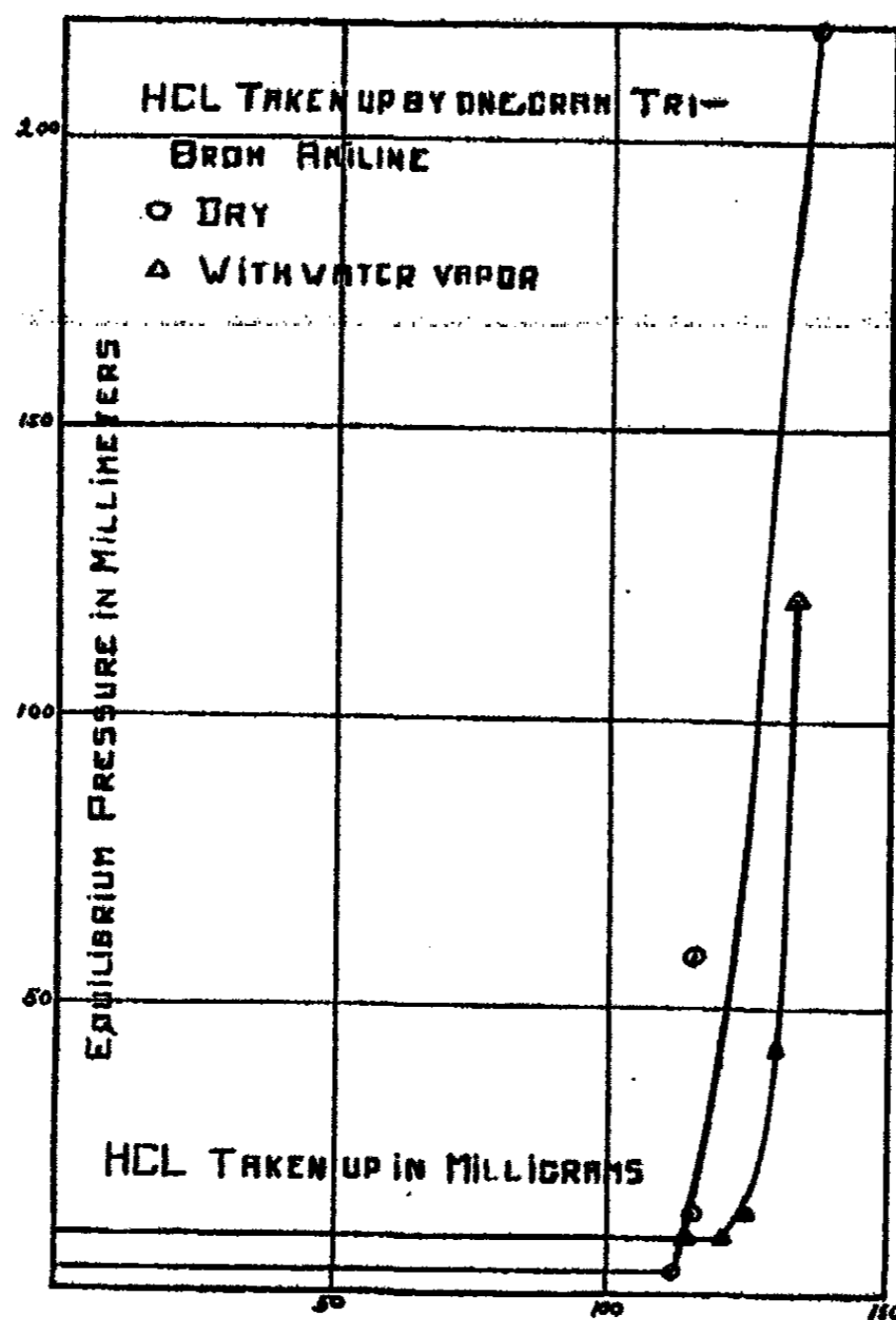

FIG. 6

If these experiments are correct, tribromaniline hydrochloride must be formed in aqueous solution if the partial pressure of the hydrogen chloride is greater than the dissociation pressure of the compound. Three experiments were run to show this. The data are given below in Table VI are plotted on the triangular diagram in Fig. 8. The data were obtained in the following manner:

(1). The hydrogen chloride solution was weighed and titrated. The tribromaniline was weighed out and these values plotted for one point.

(2). After allowing to stand over night some of the solution was removed with a pipette weighed and titrated. This solution was diluted with water to precipitate any tribromaniline dissolved. This tribromaniline was weighed and the data plotted to give a second point.

(3). The remainder of the solution was filtered off on a Buchner funnel; the wet precipitate was weighed out and titrated and the tribromaniline determined for the third point.

TABLE VI

	1	2	3
1. Acid	6.035 N		11.02 N
Wt. of solution	55 gm = 5000		
Wt. of tribromaniline	10.09 gms.		
T.B.A. =	15.4% = 10 gms.	16.4% = 10.0 gm.	14.58% = 10 gm.
H <sub>2</sub> O =	67.63% = 43.96 gms.	61.7% = 42 gm.	56.17% = 38.53%
HCl =	16.95% = 11.04 gms.	23.5% = 16 gm.	27.26% = 20.07%
2. Wt. of 1000 solution	11 gms.	11.5 gm.	10.7 gm.
HCl =	19.8% = 2.18 gms.	26.7% = 3.1 gm.	35.5% = 3.8 gm.
H <sub>2</sub> O =	80%	72.6% = 8.35 gm.	63.5% = 6.8 gm.
T.B.A. =		0.5% = .06 gm.	1.0% = 0.1 gm.
3. Wt. of wet precipitate	12.2 gms.	14.0 gm.	14.7 gm.
T.B.A. =	82% = 10 gms.	67.8% = 9.5 gm.	64.1% = 9.4 gm.
HCl =	4.1% = 0.49 gms.	14.4% = 2.01 gm.	15.8% = 2.32 gm.
H <sub>2</sub> O =	13.9% = 1.7 gm.	17.8% = 2.5 gm.	20.4% = 3.0 gm.

When a line is drawn through the three points obtained in this way we can tell the composition of the solid phase. If the line cuts the diagram at the corner, pure tribromaniline is the solid phase; this was the case in one experiment. In the other two cases the line cuts the diagram on the line representing HCl-T.B.A. as the solid phase at about 9.0 percent hydrochloric acid or 91 per cent tribromaniline. This is close enough to the theoretical of 90 per cent tribromaniline to justify the conclusion that tribromaniline hydrochloride is formed from aqueous solution by adding hydrochloric acid to tribromaniline if the solution is concentrated enough.

In the experiments with hydrogen chloride the tribromaniline took up 112 mgms. of hydrogen chloride against a theoretical of 111 mgms. for an error of 0.9 percent. The benzoquinone took up 309 mgms. of the gas against a theoretical of 338 mgms. for an error of 8.5 percent.

(6). Hexamethylene tetramine, a condensation product of formaldehyde and ammonia, was next tried with hydrogen chloride. According to the literature this compound reacts with only one or two molecules of hydrogen chloride while under the conditions of our experiment it reacts with four molecules of hydrogen chloride to give a curve with four distinct flat portions, a vertical rise between each and a nearly vertical portion after the completion

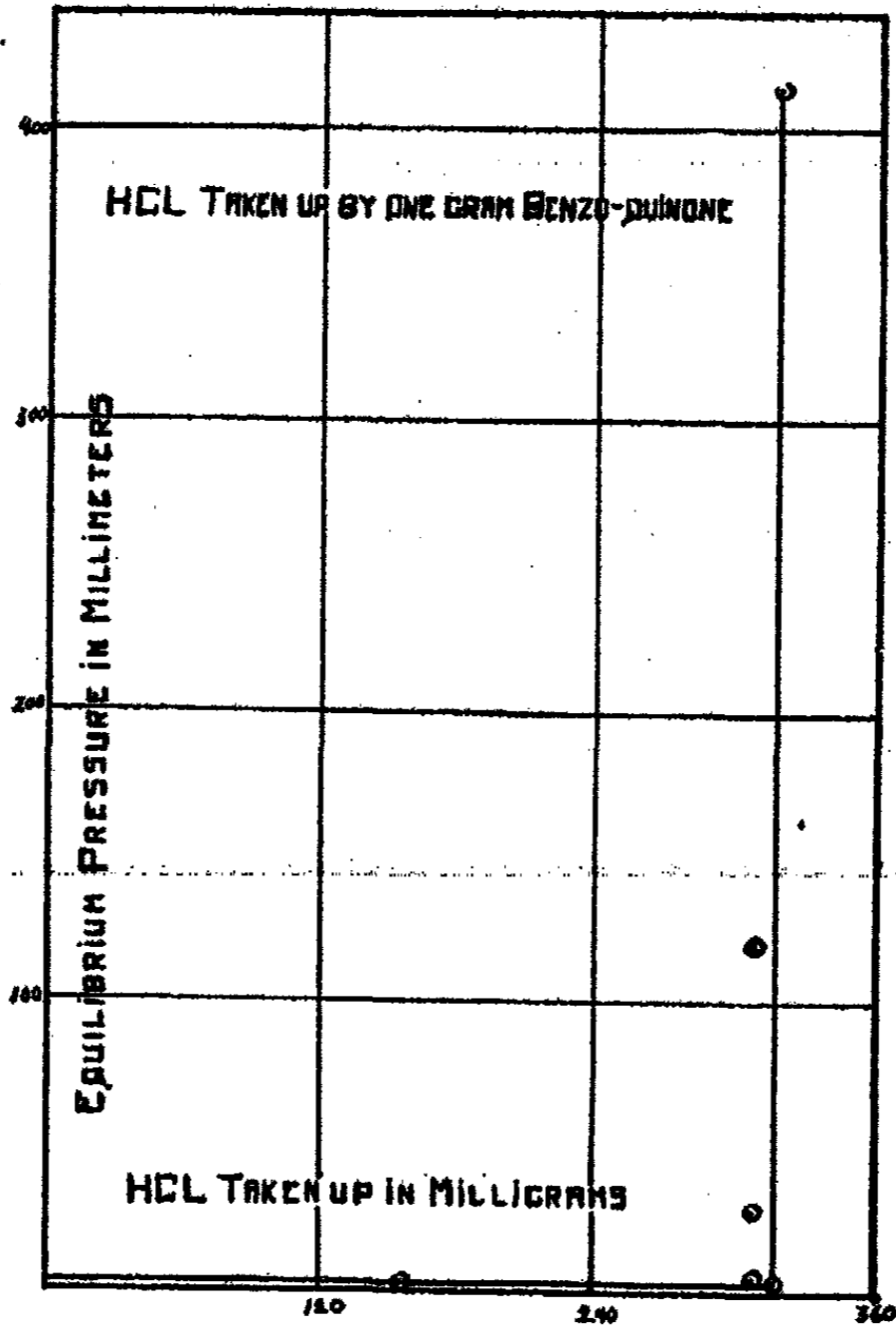

FIG. 7

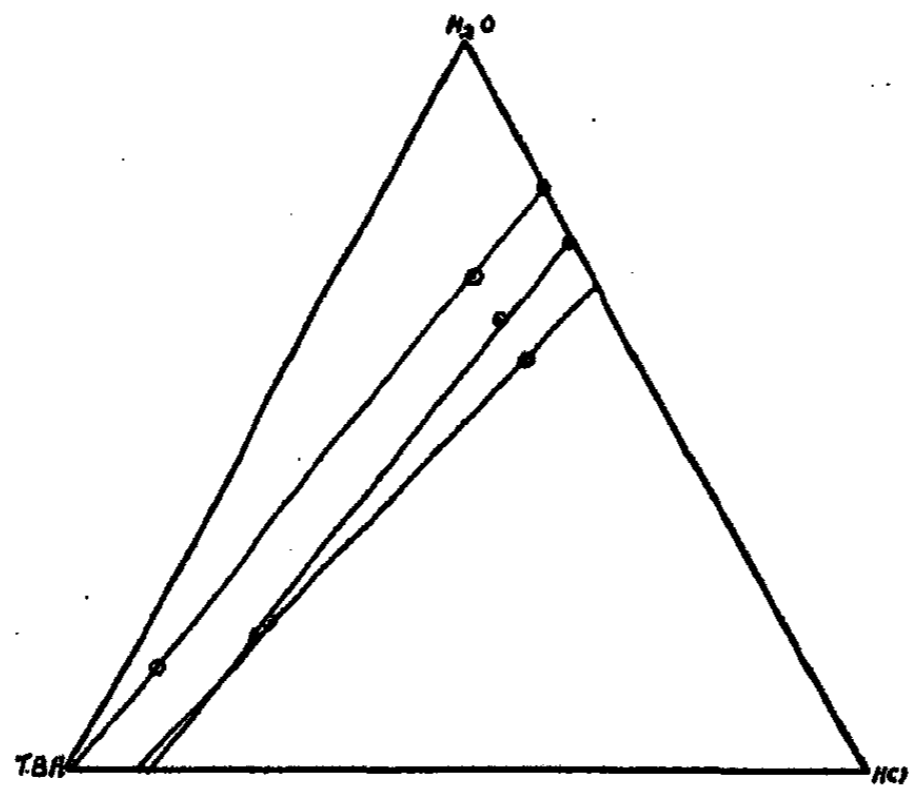
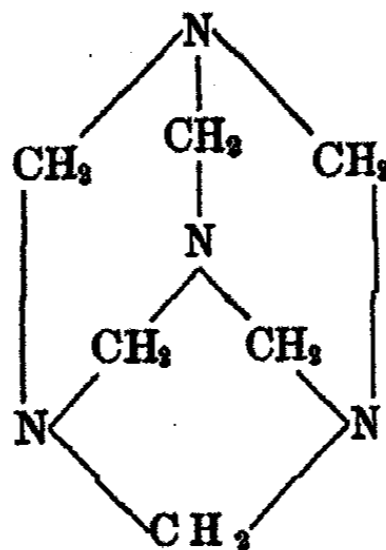

FIG. 8

of the final step. Hexamethylene tetramine may be represented by the following formula with each nitrogen atom attached to three CH<sub>2</sub> groups:



These data are given in Table VII and shown graphically in Fig. 9.

(7). The simplest of the amino acids, amino acetic acid, was tried next.

To our surprise it took up practically no ammonia  $\begin{matrix} \text{H} & \text{H} \\ | & | \\ \text{N}-\text{C} & \text{COOH} \\ | & | \\ \text{H} & \text{H} \end{matrix}$  at all. No

TABLE VII  
Hexamethylene Tetramine and Hydrogen Chloride  
Sample = 2.39 grams.

Vol. HCl added	Volume removed	Net volume	P <sub>2</sub>	Volume remaining	Vol. taken up	Wt. HCl taken up	Wt. HCl taken up per gm.
cc	cc	cc	mm.	cc	cc	mgm.	mgm.
68	26	42	2	—	42	61	41
391	40	393	12	4	389	637	277
294		687	12	4	683	1119	486
126	30	783	20	8	775	1270	552
	32	751	21	8	743	1218	530
498	114	1145	79	32	1113	1824	793
	40	1105	25	10	1095	1795	780
	42	1063	27	10	1053	1726	750
	45	1018	29	11	1507	1651	718
	18	1000	18	7	993	1628	708
171		1171	177	70	1101	1805	787
337	104	1404	67	26	1378	2260	982
	42	1362	27	10	1352	2216	964
170		1532	159	63	1469	2408	1047
	100	1432	64	25	1407	2306	1003
	44	1388	28	11	1377	2257	981
	88	1300	28	11	1289	2113	919

Sample = 3.46 grams.

316	47	269	2	1	268	439	127
338	161	446	2	2	444	728	210

one else has found a compound in this case and the acid may be obtained by crystallization from about concentrated ammonia solution. This may be explained by assuming that the  $\text{NH}_2$  group and the  $\text{COOH}$  group neutralize one another internally. If one takes a stronger amino acid it is possible to obtain compounds with ammonia. Glutamic acid, for example, which may be represented by the formula:

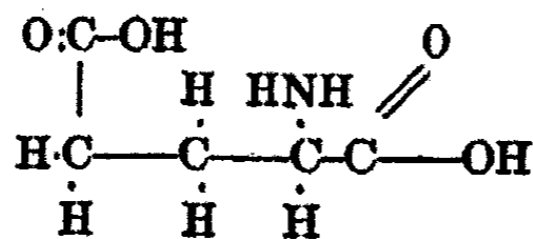

reacts with one mol of ammonia. The data for amino acetic acid and for glutamic acid, both purified and "technical," are given in Table VIII and plotted in Fig. 10. The difference between the pure and "technical" glutamic acid is negligible so far as the principle goes.

8. In Fig. 11 are shown the data for p-aminobenzoic acid and a mixture of aminobenzoic acid and aminosulfonic acid. The data are given in Table IX.

TABLE VIII

## Amino Acetic Acid and Ammonia

Sample = 0.318 gms. Dry

Vol. $\text{NH}_3$ added cc	Vol. $\text{NH}_3$ removed cc	Total Vol. Std. Cond. cc	$\text{P}_2$ mm.	Volume remaining cc	Total Vol. taken up cc	Total Wt. taken up mgm	Wt. $\text{NH}_3$ taken up per gm. mgm
16		14.2	34	14	—	—	—
56.4		64.6	155	65	—	—	—
74.4		131	318	132	—	—	—
193.8		303	749	305	—	—	—
67.6		363	884	365	—	—	—
68.6		424	1024	425	—	—	—

## Glutamic Acid (Purified) and Ammonia

Sample = 3.612 gms.

655		585	—	288	296	228	63.4
	288	296	2	—	296	228	63.4
470		718	350	153	565	435	121
86		793	517	220	573	442	122
90		823	675	290	583	449	125
85		949	858	368	581	488	124
	90	870	685	294	576	444	123
	71	807	544	234	573	442	122
	59	755	426	184	571	440	122
	50	711	325	140	570	440	122
	80	676	245	106	570	439	121
	30	649	184	80	569	438	121
	92	568	1 mm.	0.5	567	437	121



TABLE VIII (Continued)  
Glutamic Acid (Technical) and Ammonia  
Sample = 3.6 grams.

Vol. NH <sub>3</sub> added cc	Vol. NH <sub>3</sub> removed cc	Total Vol. Std. Cond. cc	P <sub>2</sub> mm.	Volume remaining cc	Total Vol. taken up cc	Total Wt. taken up mgm	Wt. NH <sub>3</sub> taken up per gm. mgm
87		78	5	—	78	60	16.4
182		240	5	—	240	185	51
192		411	5	—	411	317	87
187		581	6	—	581	448	123
92		663	150	65	598	461	126
96		749	312	135	614	473	129
87		826	465	200	626	482	132
82		897	608	262	635	489	134
78		966	752	324	642	495	135
	77	899	607	260	639	492	135
	66	841	489	212	629	484	133
	51	797	392	170	627	482	132
	47	756	314	136	620	477	131
	36	724	247	106	618	475	130
	52	678	164	70	608	468	128
	34	648	118	50	598	460	126
	55	599	20	9	590	454	124
	10	590	5	0.4	590	454	124

TABLE IX  
p-Aminobenzoic Acid and Ammonia  
Sample = 0.7 grams.

Vol. NH <sub>3</sub> added cc	Vol. NH <sub>3</sub> removed cc	Net volume cc	P <sub>2</sub> mm	Volume remaining cc	Volume taken up cc	Wt. NH <sub>3</sub> taken up mgm	Wt. NH <sub>3</sub> taken up per gm. mgm
17		15	—	—	50	39	16.4
39		50	—	—	50	39	54
23		71	—	—	71	55	77
29		97	—	—	97	73	103
17		112	—	—	112	87	122
7		118	10	6.1	112	87	122
7		125	32	12.5	112	87	122
45		165	118	50	114	88	124
32		193	178	75	118	91	128
21		211	222	91	120	93	130
	19	195	204	85	110	85	121
	18	178	169	74	104	80	115
	14	165	144	62	103	79	113
	14	152	110	48	104	80	115

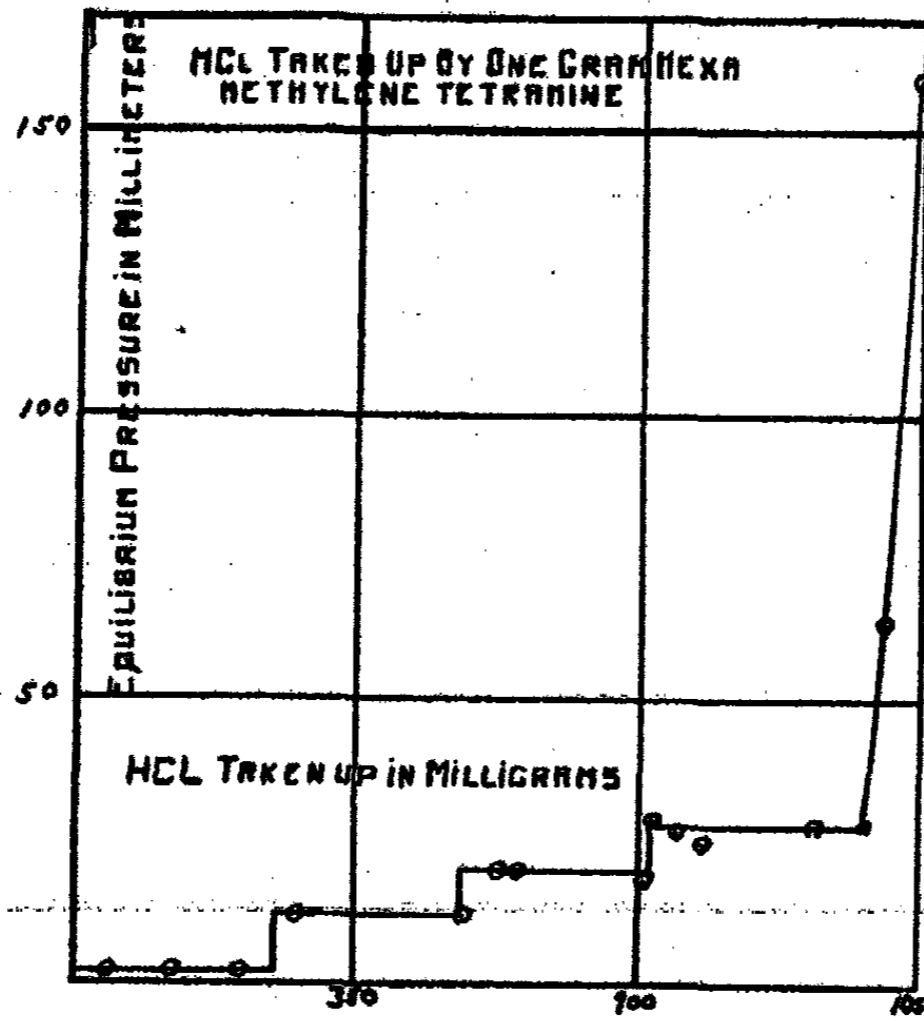

FIG. 9

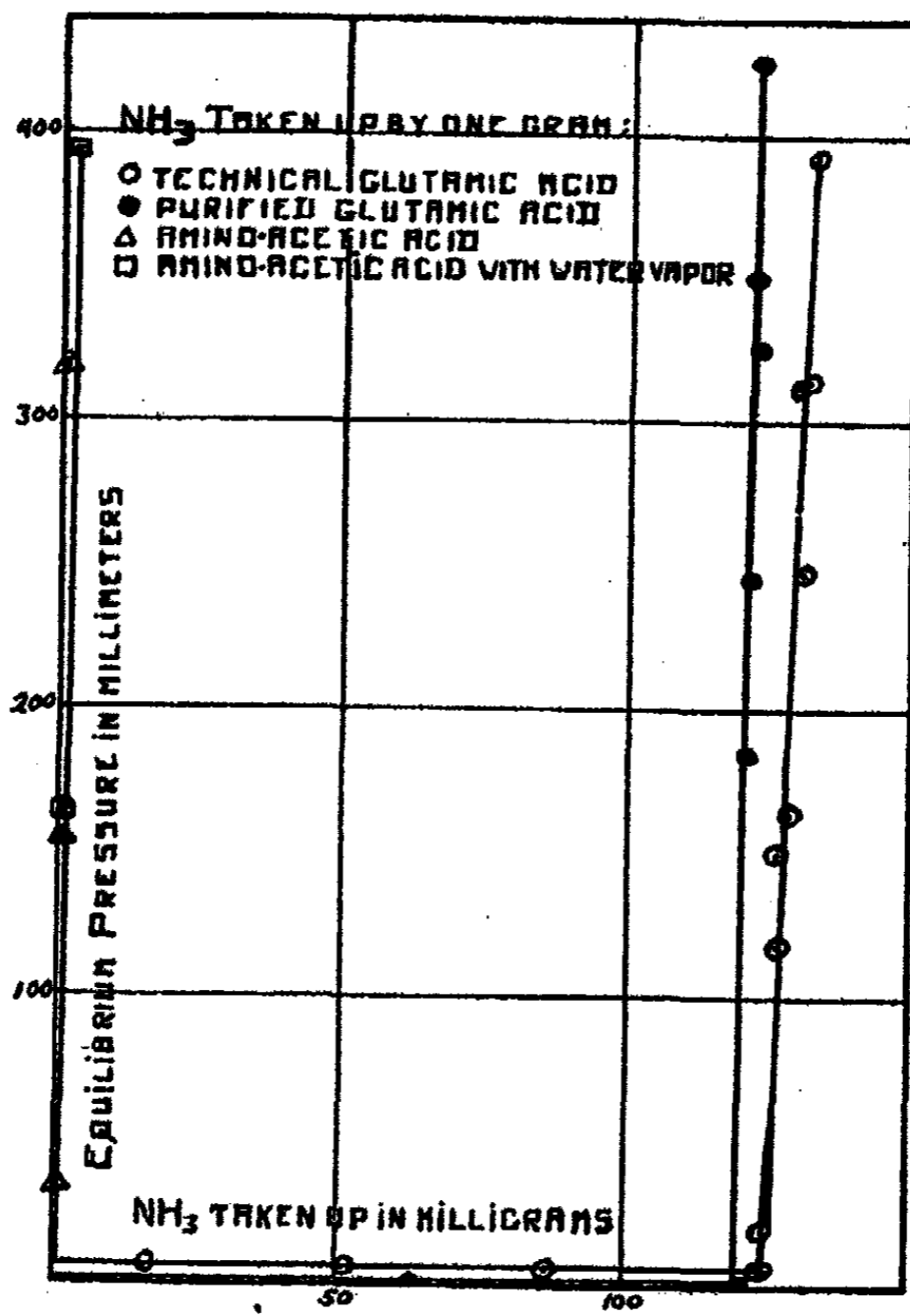

FIG. 10

TABLE IX (Continued)

p-Aminobenzoic Acid and Ammonia							
Vol. NH <sub>3</sub> added	Vol. NH <sub>3</sub> removed	Net volume	P <sub>1</sub>	Volume remaining	Volume taken up	Wt. NH <sub>3</sub> taken up	Wt. NH <sub>3</sub> taken up per gm.
cc	cc	cc	mm	cc	cc	mgm	mgm
	11	141	92	40	101	78	111
	9	132	74	32	100	77	110
	18	120	43	18	102	79	112
	11	110	20	8	102	79	112
Aminobenzoic Acid 7 grams + 3.0 grams Aminosulfonic Acid and Ammonia							
1218		1070	2	—	1070	825	80
91		1150	2	—	1150	886	86
31		1178	2	—	1178	908	90
24		1871	75	32	1839	1418	142
	35	1836	2	—	1836	1415	143
99		1925	220	96	1829	1410	141
90		2006	411	178	1828	1409	141
89		2086	595	256	1830	1411	141
91		2168	786	336	1832	1412	141
	76	2092	620	267	1825	1408	141
	72	2020	472	204	1816	1400	140
	55	1965	352	152	1813	1398	140
	136	1824	72	32	1787	1385	139

All the acids in Figs. 10 and 11 except amino-acetic acid, form definite chemical compounds with ammonia. By working with different temperatures and with different aminobenzoic acids, it would be easy to get plenty of data in regard to the free energy of substituted ammonium benzoates. The presence of aminosulfonic acid as an added impurity in the aminobenzoic acid does not change the curve appreciably.

9. In Fig. 12 are shown the data for p-aminobenzoic acid and for the two samples of glutamic acid when the abscissas are mols of ammonia taken up per mol of solid acid. While the curves do not coincide absolutely; they come pretty close together and show distinctly that glutamic acid is functioning as a monobasic acid under these conditions. Comparison of these curves with those for tartaric, succinic and stearic acids found in Fig. 4 should dispel the idea that there is anything abnormal about the amino acids.

10. While amino acetic acid is not a strong enough acid to form a compound with ammonia, it does form a definite compound with HCl, as may be seen from Fig. 13. In the curve labeled, "amino acetic acid and water," (triangles) the flat portion of the curve is raised because of the partial pressure of the water vapor. The difference in the upright portion of the curve may be due to some adsorption of water vapor causing a slight adsorption of ammonia. These data are given in Table X. They show that amino acetic

TABLE X  
Amino Acetic Acid and Hydrogen Chloride  
Sample = 0.72 gms. Dry

Vol. HCl added cc	Vol. HCl removed cc	Net volume cc	P <sub>2</sub> mm.	Volume remaining cc	Volume taken up cc	Wt. HCl taken up mgm.	Wt. HCl taken up per gm. mgm.
8		7.2	2	—	7	12	16.4
17		22.4	2	—	22	37	53
25		45	2	—	45	74	105
24		67	2	—	67	110	157
71	55	74	2	—	74	121	173
31		102	2	—	102	167	239
57		159	2	—	159	261	372
230		360	273	150	210	344	491
	150	210	2	—	210	344	491

Sample = 3.0 gms. Aq. V.P. = 22 mm.

89		79	22	—	78	127	42
89		156	22	—	155	255	85
86		232	20	—	232	381	127
94		315	20	—	315	516	172
283		563	18	—	563	924	308
284		818	20	—	818	1313	458
90		898	20	—	898	1473	491
77		967	92	30	937	1537	512
19		984	130	48	936	1536	512
92		1067	294	120	947	1553	518
90		1148	465	192	956	1567	522
88		1227	634	264	963	1577	525
	351	913	23	10	903	1480	494

acid under these conditions functions as a univalent base. In Fig. 14 are shown the data for aniline, amino acetic acid, benzoquinone, and tribromaniline.

11. In Fig. 15 and Table XI are the data for two experiments with iso-electric casein, prepared by the method of Van Slyke, and ammonia. These curves are entirely different and show no sign of the formation of a compound. As is so generally the case with adsorption, there is a certain amount of hysteresis, the curve on addition of ammonia (circles) differing a little from that on removal of ammonia (dots). This is the same type of curve as was obtained by Mr. Tsunajima. Casein will adsorb about 60 mg. of ammonia per gram of casein at 800 mm. pressure without showing any sign of compound formation.

12. In Table XII and Fig. 16 are given the data for experiments on gliadin from wheat and fibrin from blood with ammonia. Table XIII and Fig. 17 show the same type of experiments with arachin from peanuts and with zein from corn. All the curves are of the same general nature and show conclusively that there is no formation of stoichiometric chemical compounds between any of the proteins studied and ammonia. The samples of gliadin,

fibrin, arachin zein, and edestin were very pure preparations presented by Professor R. A. Gortner. Without this co-operation on his part, it would have taken very much longer to have got the data for this paper.

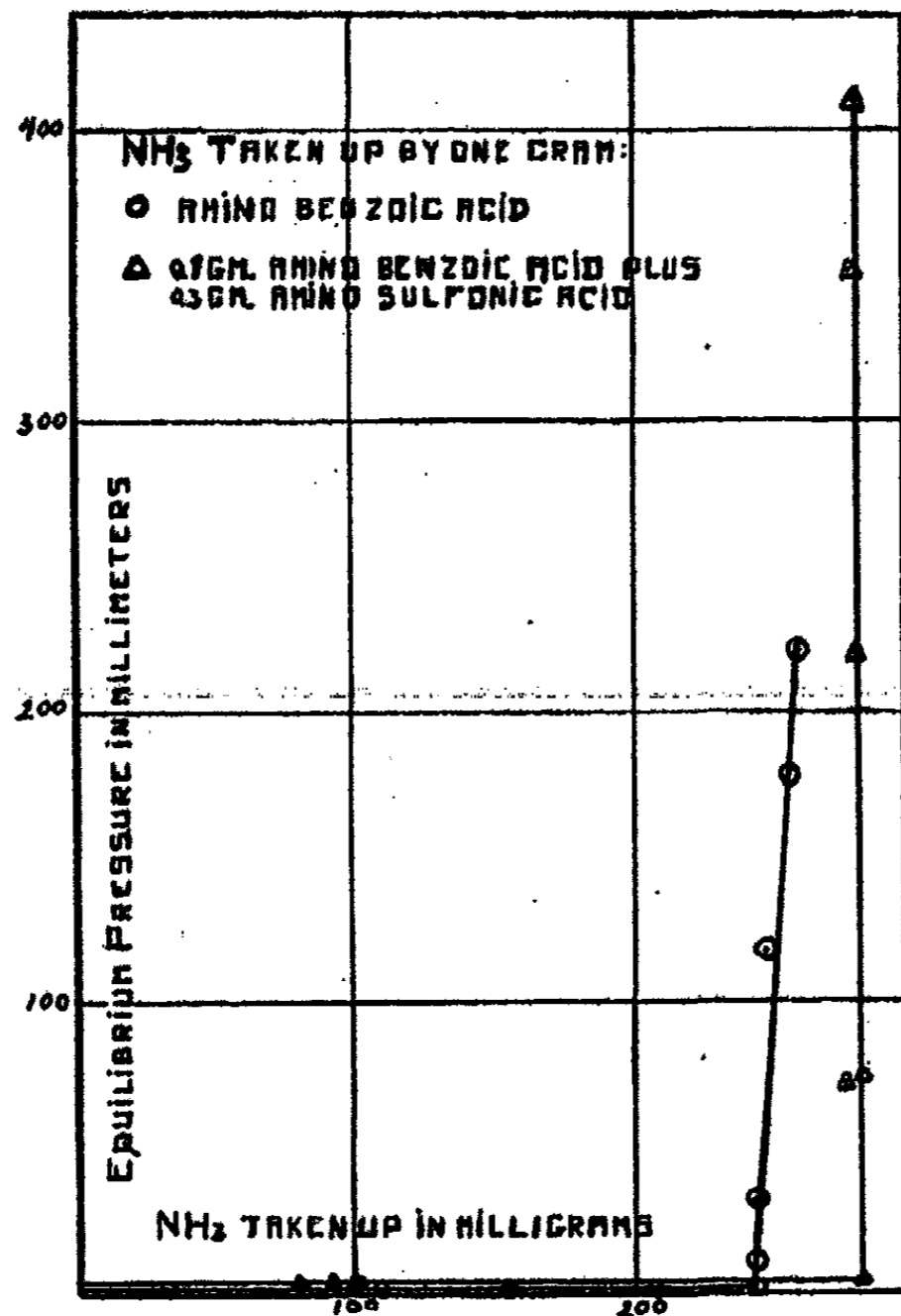

FIG. 11

13. With HCl the story is quite different. Edestin from hemp seed, which was the first protein tried, shows an initial adsorption followed by a flat in the curve. The flat portion persists until about 110 mg. of HCl are taken up by one gram of edestin. A sharp break in the curve occurs here and a rapid rise follows which however shows some adsorption. The data are given in Table XIV and are plotted in Fig. 18. The equivalent weight of edestin calculated from the above value of 100 mg. for the HCl taken up by one gram of the protein is about 330. This is not in agreement with the values of other observers. If one subtracts the 20 mg. of HCl which are involved in the initial adsorption, the equivalent weight of edestin is 405 or about one-half of Hitchcock's figure—820. This procedure would only be justified in case the compound formed adsorbed HCl in the same amount as the protein itself, a condition which one must admit is extremely improbable.

15. In Figs. 19-22 are plotted the data for arachin, fibrin, gliadin, and casein with HCl. These data are given in Tables XV-XVII. All four of the

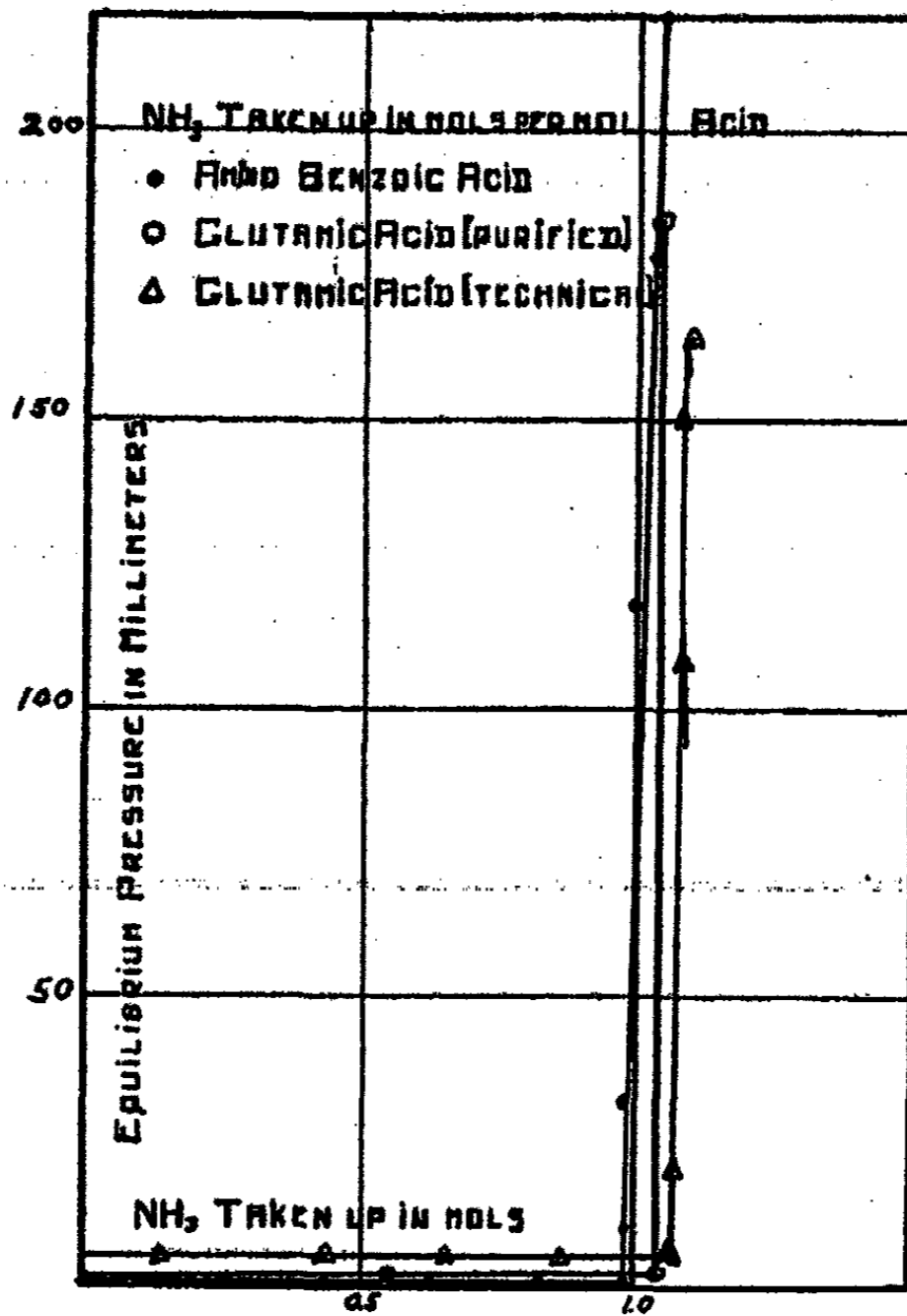

FIG. 12

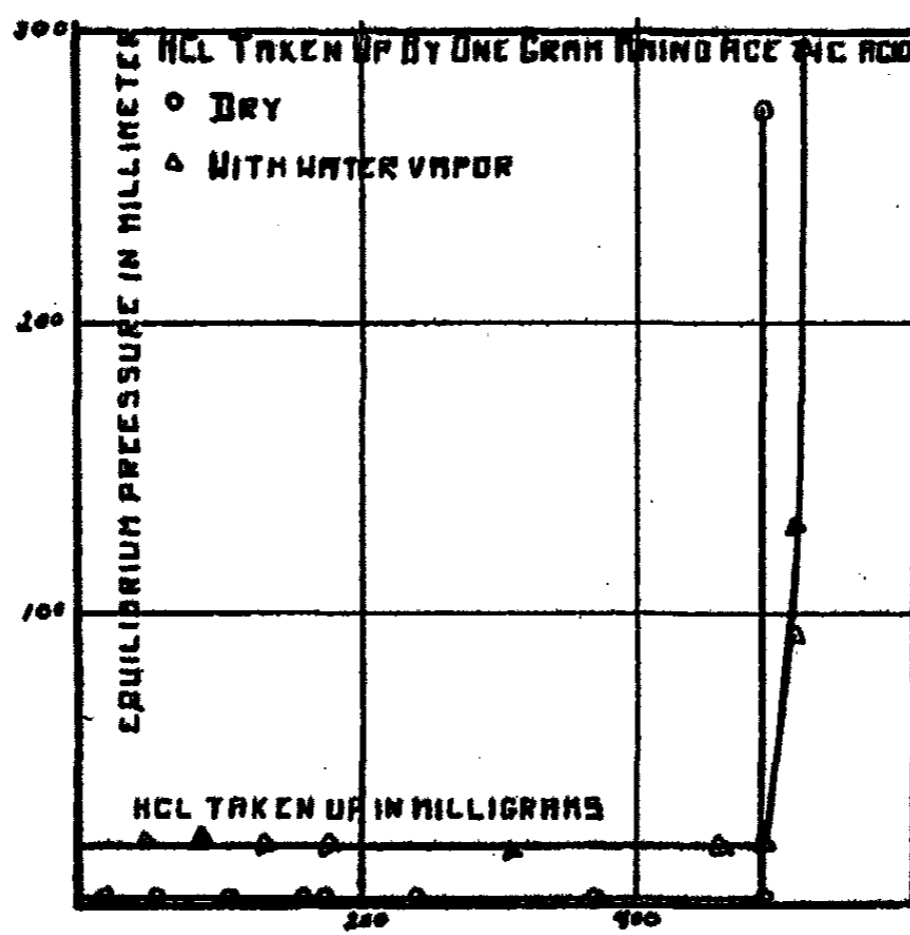

FIG. 13

TABLE XI  
Casein and Ammonia  
Sample 8.5 grams. Dry

Vol. NH <sub>3</sub> added cc	Vol. NH <sub>3</sub> removed cc	Net volume cc	P <sub>2</sub> mm.	Volume remaining cc	Volume taken up cc	NH <sub>3</sub> Wt. taken up mgm.	NH <sub>3</sub> Wt. taken up per gm. mgm.
28		25	4	1	24	19	2
30		52	12	4	48	37	4
24		74	16	6	68	52	6
23		95	19	8	87	67	8
68		157	32	14	143	110	13
86		235	58	25	210	162	19
36		267	122	52	215	166	20
	11	257	102	44	213	164	19
95		342	141	61	281	216	26
91		424	204	89	335	258	30
89		504	280	121	383	295	35
89		584	333	144	440	339	40
92		667	431	186	481	370	44
93		751	500	216	535	412	49
86		829	610	262	567	438	51
92		912	690	296	616	474	56
94		997	799	343	654	504	59
	77	927	685	294	633	488	57
	64	870	605	260	610	470	55
	197	694	382	166	528	406	48
	126	581	256	111	470	363	43
	153	442	146	64	378	291	34
	24	420	131	57	363	279	33
	72	356	87	40	316	243	29
	43	318	65	28	290	223	26
	37	285	45	20	265	204	24
	9	277	37	18	259	199	23
	12	266	35	16	250	192	22
	30	236	36	16	220	169	20
	16	220	36	16	204	157	18
	18	202	28	12	190	146	17
	82	120	16	8	112	84	10
	30	90	12	4	85	65	8
32		31	16	1	30	23	1
39		69	19	2	67	51	3
81		147	24	5	142	109	5
98			38	10	—	—	—
91			54	—	—	—	—
93	42	357	48	18	340	262	13

TABLE XI (continued)

## Casein and Ammonia

Sample = 2.0 grams Aq. V.P. = 14 mm.

Vol. NH <sub>3</sub> added cc	Vol. NH <sub>3</sub> removed cc	Net volume cc	P <sub>2</sub> mm.	Volume remaining cc	Vol. taken up cc	Wt. NH <sub>3</sub> taken up mgm.	Wt. NH <sub>3</sub> taken up per gm. mgm.
98	18	426	75	25	400	308	15
98		513	49	—	—	—	—
85		589	97	40	550	423	21
90	6	664	127	48	616	474	24
293		926	227	90	836	644	32
287	7	1185	341	137	1048	807	40
282	11	1427	440	177	1250	1040	52
285		1681	451	226	1455	1121	56
190		1850	586	250	1600	1233	61
	311	1539	412	175	1364	1051	52
	354	1185	247	105	1080	732	36
	272	913	188	80	833	639	31
	202	711	118	50	661	508	25
	120	590	84	37	554	424	21
	110	480	75	33	445	343	17
	80	400	52	23	377	290	15
	90	310	63	25	285	219	11
	62	250	50	20	230	177	9
	60	190	18	7	183	138	7
	109	81	16	6	75	58	3

proteins show curves with a flat portion which is followed by a sharp break and a smooth rising curve. This type of curve indicates the formation of a compound which then adsorbs HCl. All the curves except that for gliadin, show only one step. In the case of gliadin we have three well-defined flat portions in the curve with a sharp rise between each and with adsorption being indicated after the last step. Since the lengths of the three flats in the diagram for gliadin are in the ratio 2:3:4, it follows that the numbers of nitrogens reacting stoichiometrically with hydrogen chloride along three flats are also in the ratio 2:3:4, and that the total number of nitrogen atoms per molecule which react stoichiometrically with hydrogen chloride is some multiple of nine.

16. Zein, when tried with HCl, gave no indication of the formation of a chemical compound. These data are plotted in Fig. 23 and are given in Table XVIII. The curve is a characteristic adsorption curve throughout the entire range. This might be expected from the rather unusual composition of the protein.

Cohn<sup>1</sup> estimates that zein contains three mols of aspartic acid, three mols of  $\beta$  hydroxyglutamic acid, and forty-one mols of glutamic acid—a total

<sup>1</sup> E. J. Cohn: J. Gen. Physiol., 7, 45 (1924).



of 47 mols of di-carboxylic acids. Assuming 41 mols of NH<sub>3</sub> which represent amide bound carboxyl groups there would be six free carboxyl groups. He calculates the equivalent weight of zein against NaOH as 3400.

TABLE XII  
Gliadin and Ammonia  
Sample = 10.5 grams

Vol. NH <sub>3</sub> added cc	Vol. NH <sub>3</sub> removed cc	Net volume cc	P <sub>2</sub> mm.	Volume remaining cc	Volume taken up cc	Wt. NH <sub>3</sub> taken up mgm.	Wt. NH <sub>3</sub> taken up per gm. mgm.
30		30	22	10	20	15.4	1.5
18		48	34	15	33	25.4	2.4
76		124	82	35	89	76.3	7.3
84		208	154	65	143	110	10.5
82		290	225	95	195	150	14.3
	154	136	106	45	91	70	6.7
	80	56	55	22	34	26	2.5
	48	8	33	15	—	—	—
27	20	7	11	5	2	1.5	0.15
46		53	34	15	38	29	2.8
34		87	55	22	65	50	4.8
74		161	111	47	114	88	8.4
13		174	122	60	114	88	8.4
74		248	175	73	175	134	12.8
	86	162	119	50	112	86	8.2
	84	78	59	24	54	54	4
	38	40	43	17	23	17.7	1.7
	18	22	33	13	9	6.9	0.7
	28	—	31	10	—	—	—

Fibrin and Ammonia  
Sample = 7.5 grams

87		77	25	11	66	51	6.8
93		159	73	32	127	78	10.4
100		248	128	55	193	149	19.8
94		330	205	85	245	189	25.2
49		374	250	105	269	207	27.6
	156	218	108	45	173	133	17.7
	83	135	58	25	110	85	11.3
	40	95	28	12	83	64	8.5
	22	73	15	7	66	51	6.7
	15	58	9	5	53	41	5.4
	11	47	8	4	43	33	4.4
	10	37	7	3	34	26	3.5
	6	31	5	2	29	22	2.9
	6	25	4	2	23	18	2.3
	10	15	3	1	14	11	1.4

TABLE XIII  
Arachin and Ammonia  
Sample = 5 grams

Vol. NH <sub>3</sub> added cc	Vol. NH <sub>3</sub> removed cc	Total volume cc	Equilibrium pressure mm.	Volume remaining cc	Volume taken up cc	Wt. NH <sub>3</sub> taken up mgm.	Wt. NH <sub>3</sub> taken up per gm mgm.
36		32	10	4	28	22	4
61		86	22	9	77	59	11
96		172	82	35	137	106	21
98		258	158	65	193	148	30
95		343	276	115	228	175	35
187		511	483	203	308	237	48
	252	259	175	75	184	142	28
	98	161	68	30	131	100	20
	56	105	38	17	88	67	14
	28	77	19	8	69	53	11
	36	41	10	5	36	27	5.6
	12	29	8	4	25	19	4
	10	19	6	3	16	12	2.4
	7	12	5	2	10	8	1.5
	5	7	4	1	6	5	1.

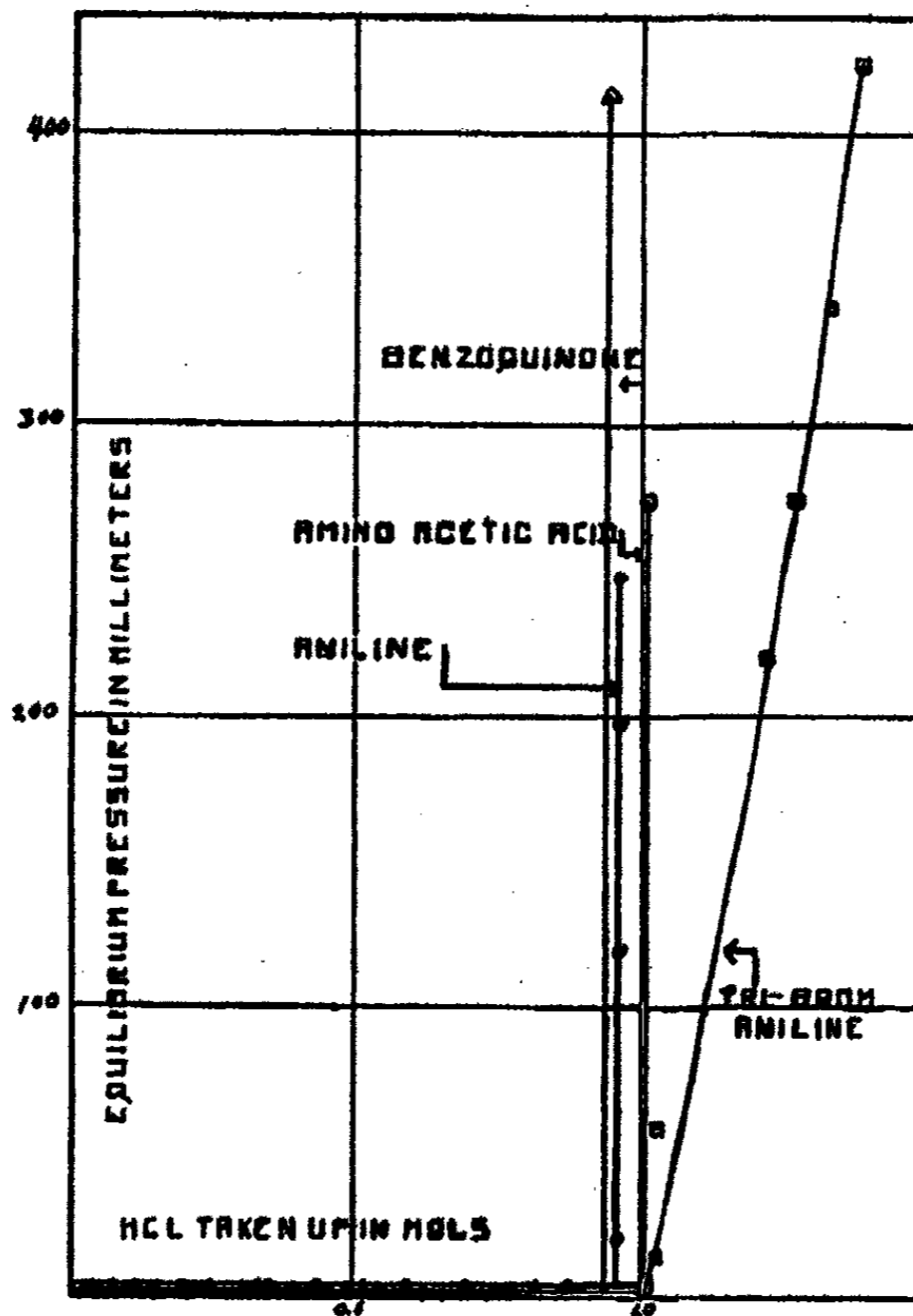

FIG. 14

TABLE XIII (Continued)

Vol. NH <sub>3</sub> added cc	Volume NH <sub>3</sub> removed cc	Total volume cc	Equilibrium pressure mm.	Volume remaining cc	Volume taken up cc	Wt. NH <sub>3</sub> taken up mgm.	Wt. NH <sub>3</sub> taken up per gm. mgm.
Zein and Ammonia Sample = 8.4 grams							
38	14	20	12	5	15	11	1
39	—	55	24	10	45	35	4
72	10	109	67	26	83	64	8
95	26	168	120	50	118	91	11
96	—	253	190	80	173	133	16
94	—	337	222	93	244	188	22
98	46	378	286	124	254	195	23
93	—	461	362	150	311	239	29
95	—	546	440	185	361	278	33
	247	299	166	65	234	180	21
	110	189	75	32	157	120	14
	62	127	42	20	107	82	10
	38	89	25	12	77	59	7
	30	59	19	8	51	39	5
	22	37	16	7	30	23	3
	18	19	12	5	14	11	1
	10	9	8	3	6	5	0.5

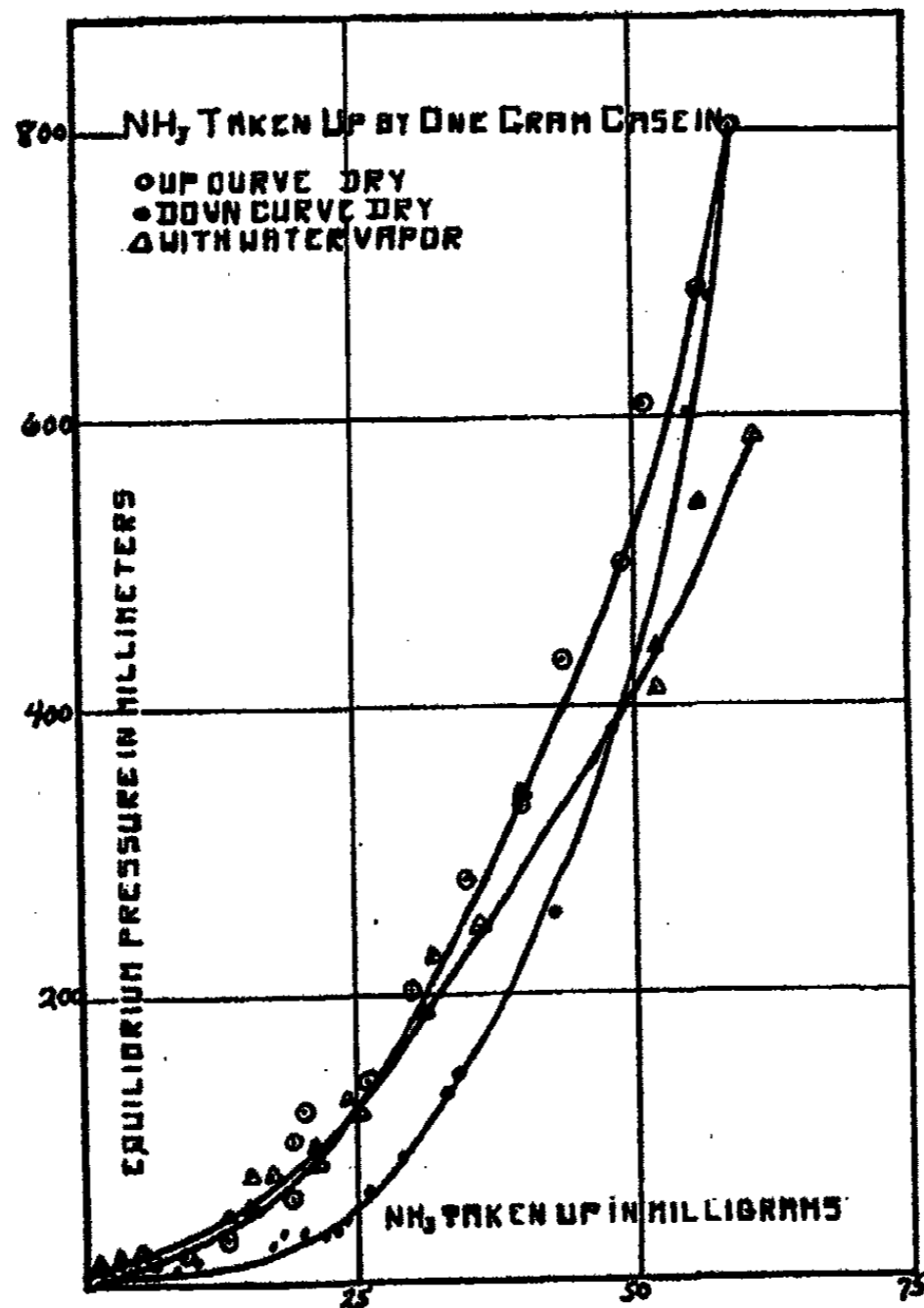

FIG. 15

In these experiments it is necessary to keep the HCl pressure at a low value to prevent discoloration and decomposition of the proteins. In spite of all precautions arachin was turned quite pink by the acid; casein, edestin, fibrin, and gliadin were colored slightly. Zein was apparently unattacked by the acid.

The equivalent weights of the various proteins may be determined from the point at which the final break occurs in the curves which show compound formation. When this is done we get 300 or 405 for edestin, 450 for casein,

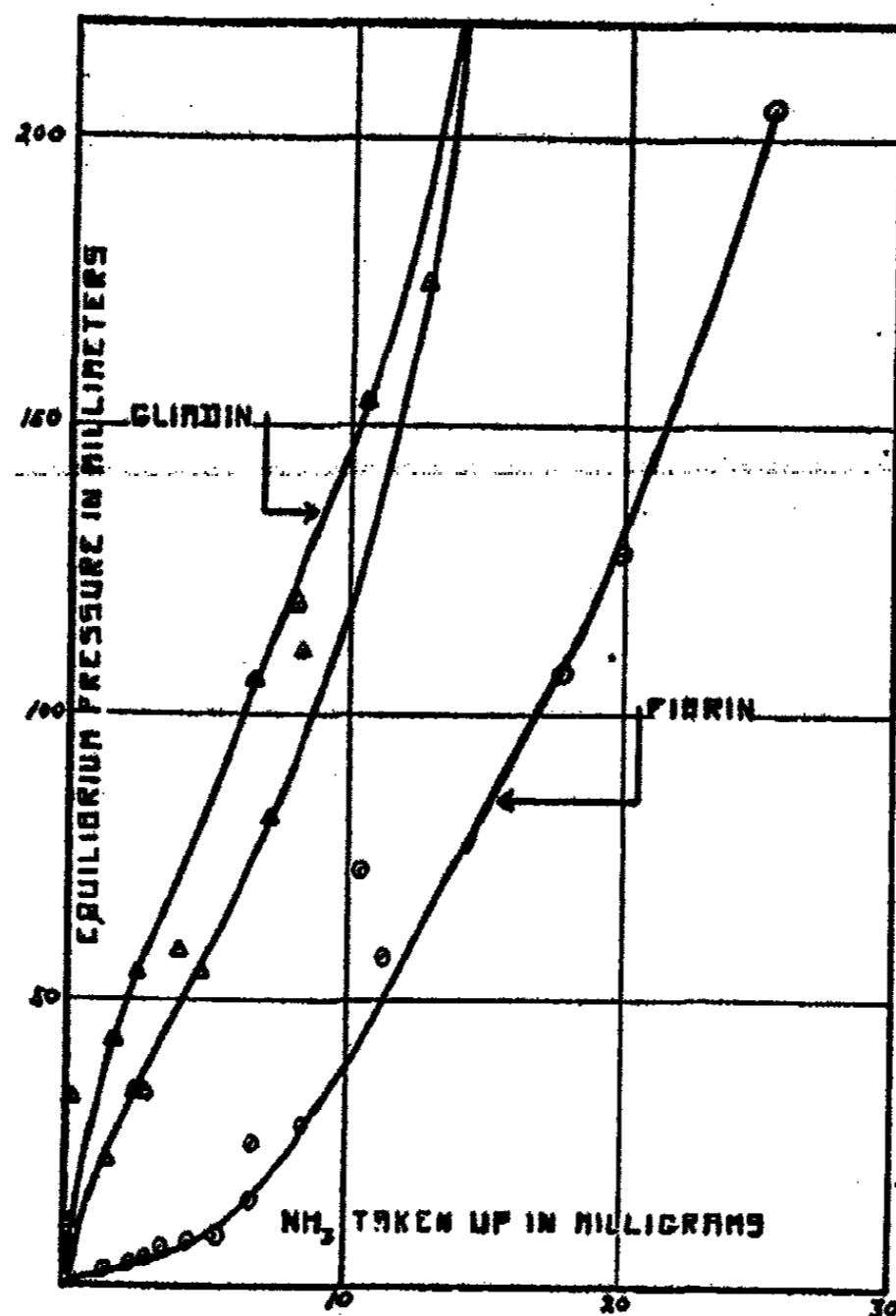

FIG. 16

365 for fibrin, 280 for arachin, and 250 for gliadin. Since there must be at least nine active nitrogens in gliadin, the molecular weight of gliadin must be some multiple of 2250 in round numbers.

These values are uniformly lower than those obtained by any other method. In the case of edestin if we take the larger figure we come close to one half of Hitchcock's value of 820. For casein the equivalent weight cited above is in good agreement with a recorded value of 440 but is much lower than those generally given.

17. Finally, as a check upon the apparatus and in order to show what kind of curve would be obtained when there was no question as to the interpretation of the results, we have run the adsorption curve for HCl on charcoal. The data are given in Table XVIII and plotted in Fig. 24.

TABLE XIV

Edestin and Hydrogen Chloride

Vol. HCl added cc	Vol. HCl removed cc	Total Vol. HCl cc	Equilibrium pressure cc	Vol. HCl remaining mm.	Total Vol. HCl taken up cc	Wt. HCl taken up mgm.	Wt. HCl taken up per gm. mgm.
10		9	4.5	0.9	7.9	12.7	2.15
12		19	5.0	1	18.4	30.2	5.03
8		26	5.5	1.1	25.3	41.5	6.9
21		45	7.0	1.4	43.5	71.3	11.9
15		59	8.0	1.6	56.9	93.3	15.5
19		16	9.0	1.8	73.7	121	20.1
15	15	89	9.0	1.8	87.2	136	22.7
92		171	9.0	1.8	169.2	277	46
59		224	9.0	1.8	222.2	364	60.7
89		303	18	2.7	300	492	82
89		381	16	3.6	377	618	103
83		456	48	9	447	733	122
99		544	116	23	521	854	142
99		632	168	33	599	982	164
98		719	276	55	664	1090	181
	27	695	238	47	648	1062	177
	24	673	204	40	633	1037	173
	69	613	97	20	593	972	162
	41	576	59	12	564	924	154
	44	536	35	7	529	867	144
	30	510	25	5	505	828	138
	14	498	22	4	494	810	135
	16	484	20	4	480	787	131
	12	474	18	3	471	772	128
	12	464	18	3	461	755	126
	3	461	16	3	458	750	125
	24	437	13	7	432	708	118
	14	423	11	6	418	688	115
	14	409	9	5	404	622	110
	14	395	9	5	390	639	106
	14	381	9	5	376	616	103
	14	367	9	5	362	593	99
98		454	107	22	432	708	118
	66	388	52	11	377	618	103
	16	372	13	3	370	606	101
	10	362	8	2	360	590	99
	11	351	9	2	349	572	95

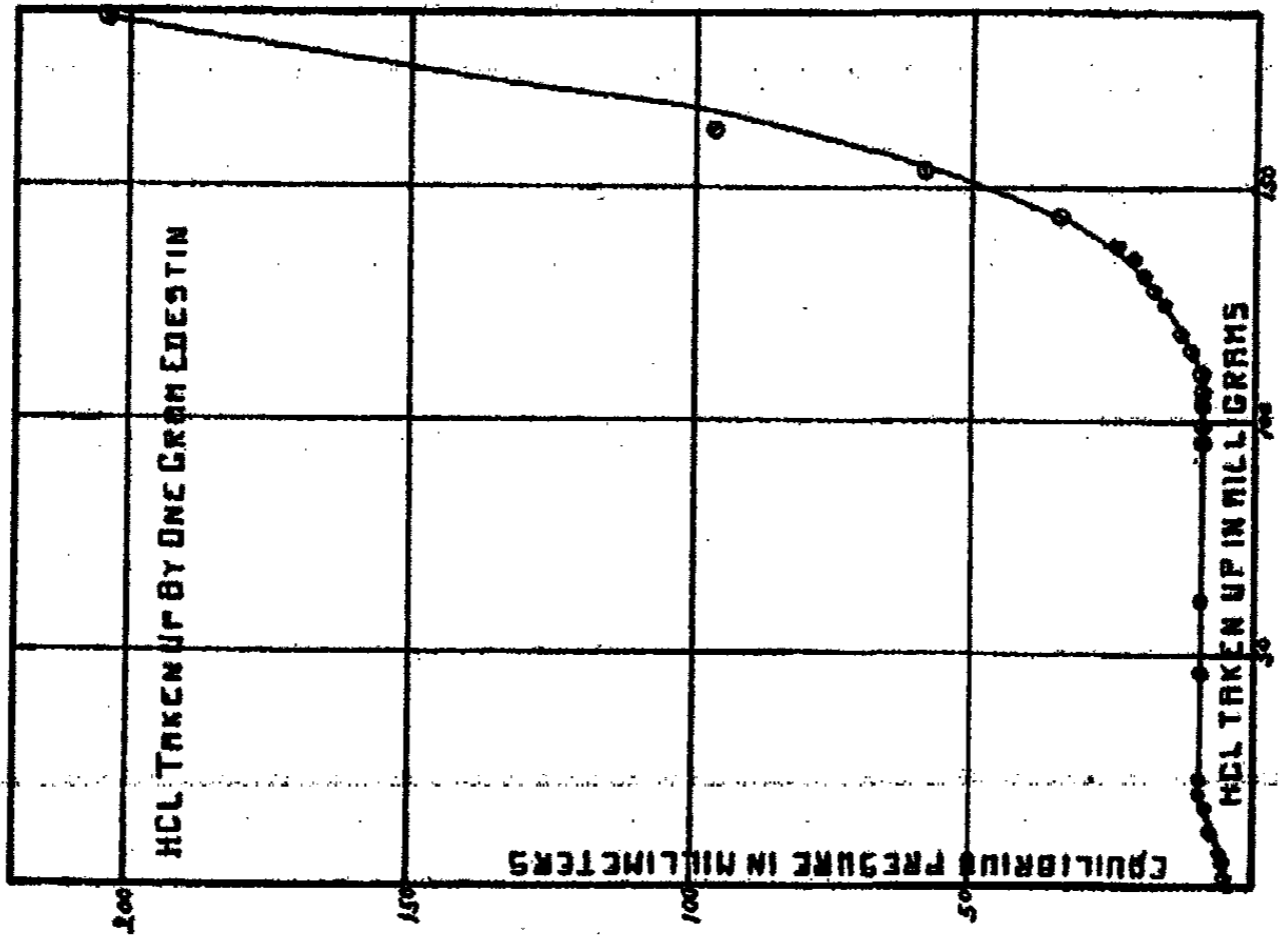

FIG. 18

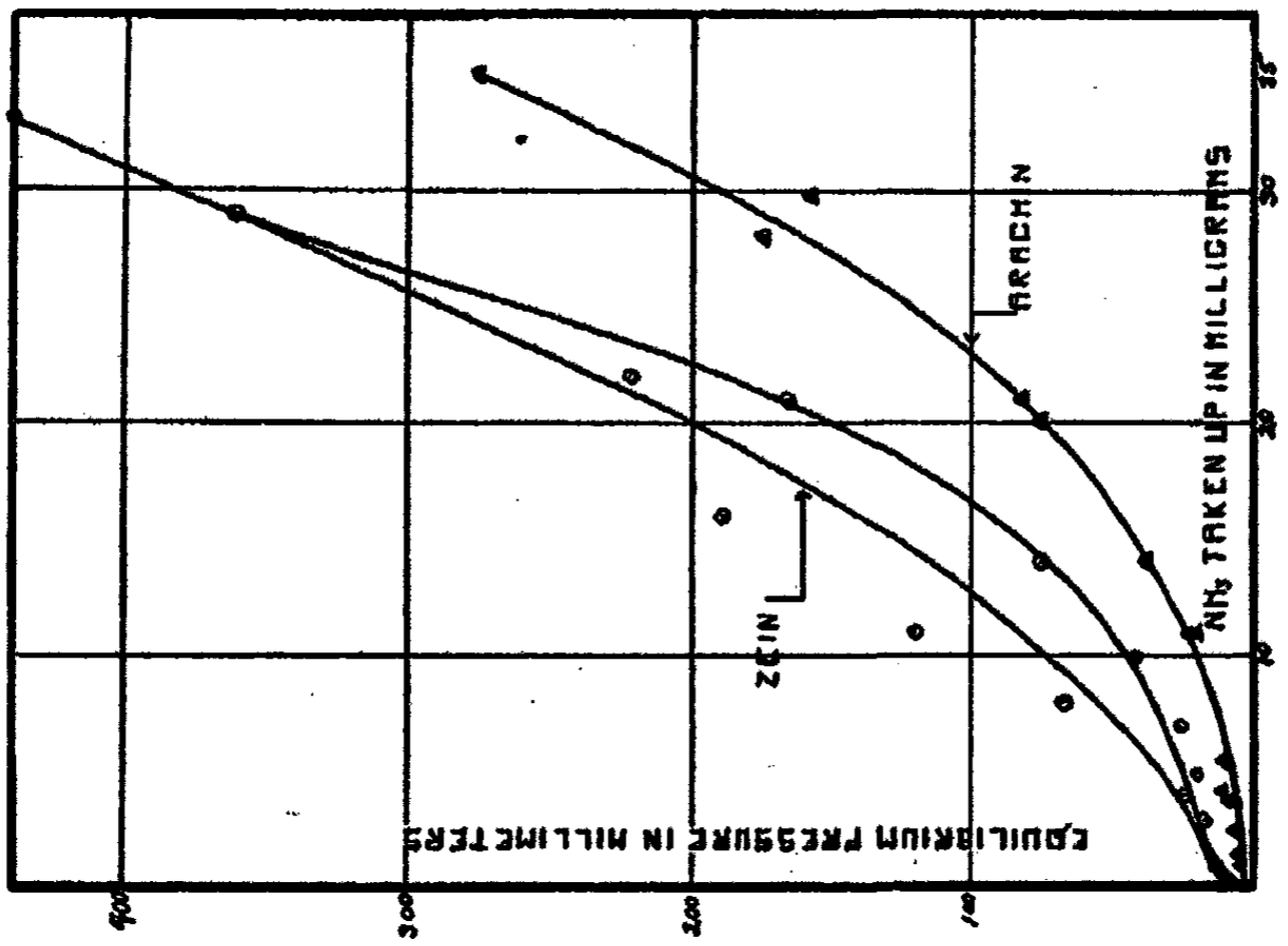

FIG. 17

4. *Conclusions.*

The general conclusions to be drawn from this paper are:

1. The pressure-concentration curves for ammonia or hydrogen chloride with solid acids or bases show clearly whether a definite chemical compound is or is not formed.
2. Presence of moderate amounts of water or other impurities displaces the curve but does not change its type.
3. With tartaric acid measurably different dissociation pressures are obtained for the two ammonium salts; but this is not the case for succinic acid at room temperature. At higher temperatures it is possible to differentiate the two ammonium salts of succinic acid.

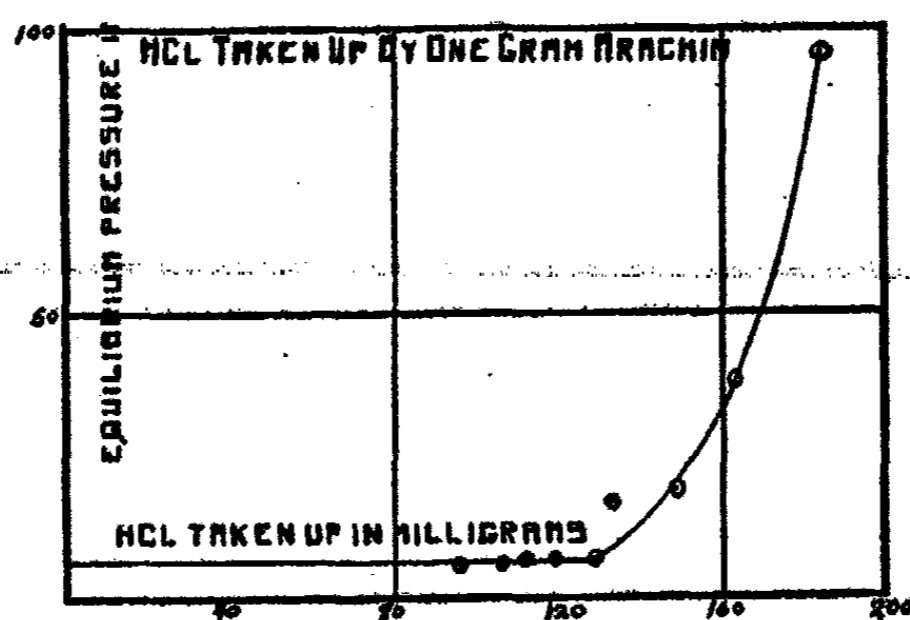

FIG. 19

4. Owing to the slight solubility of aniline hydrochloride in aniline, it is possible to apply the method even though aniline is a liquid at room temperature.
5. Tribromaniline forms a definite chemical compound with hydrogen chloride. The same compound is formed in aqueous solution if the acid is concentrated enough.
6. Hexamethylene tetramine reacts with four mols of hydrogen chloride to give a curve with four distinct steps.
7. Amino acetic acid takes up practically no ammonia at all. This is in line with the known fact that the free acid will crystallize from a concentrated solution of ammonia in water.
8. Aminobenzoic and glutamic acids form definite chemical compounds with ammonia, the glutamic acid behaving as a monobasic acid.
9. Amino acetic acid forms a definite chemical compound with hydrogen chloride.
10. Casein, zein, arachin, fibrin, and gliadin adsorb ammonia readily with no evidence of any formation of any chemical compound.
11. Casein, arachin, fibrin, gliadin, and edestin do form definite compounds with hydrogen chloride. The equivalent weights of these proteins calculated from the acid-binding power here presented are not in agreement with those of any other observer.

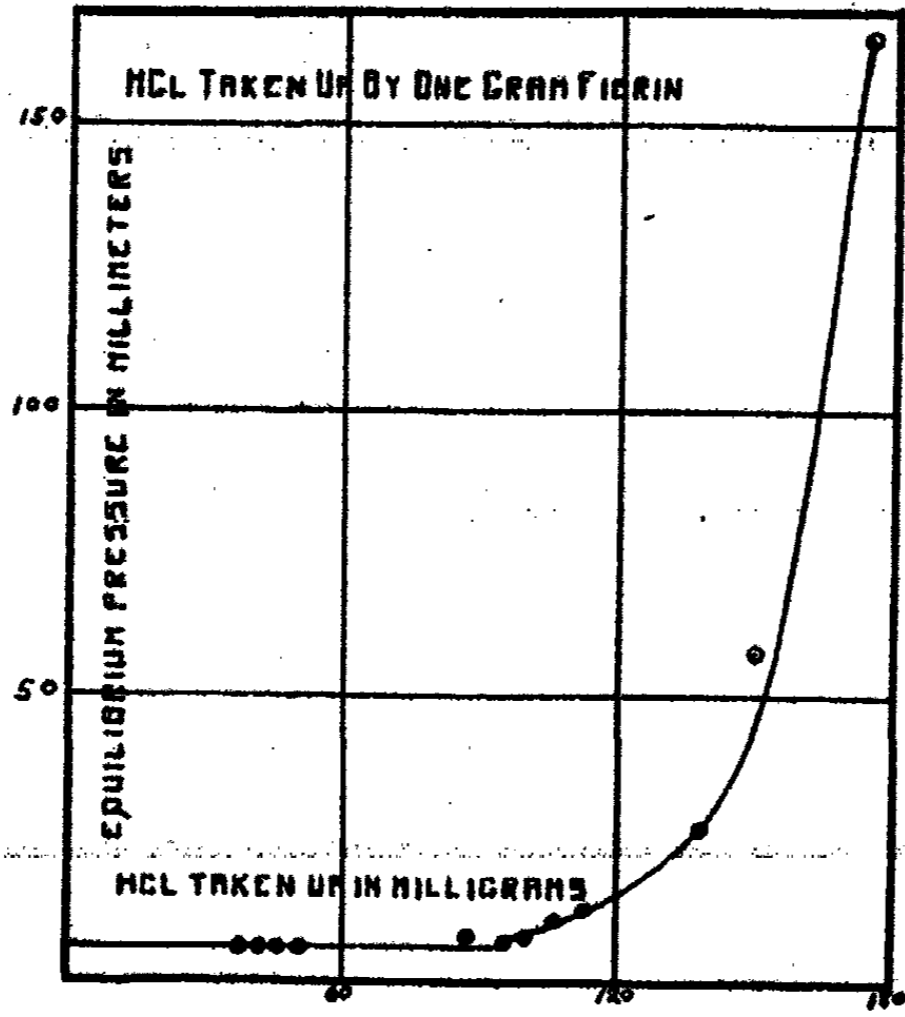

FIG. 20

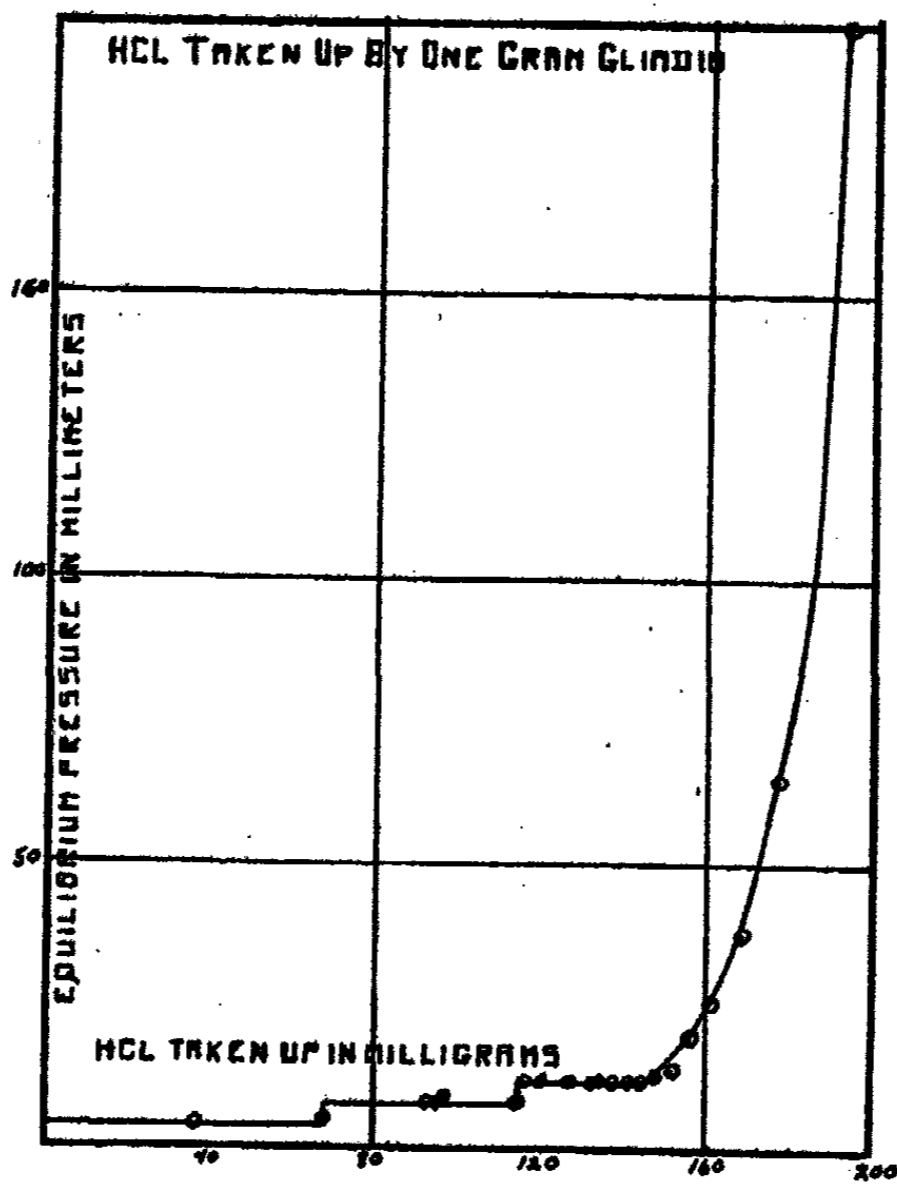

FIG. 21



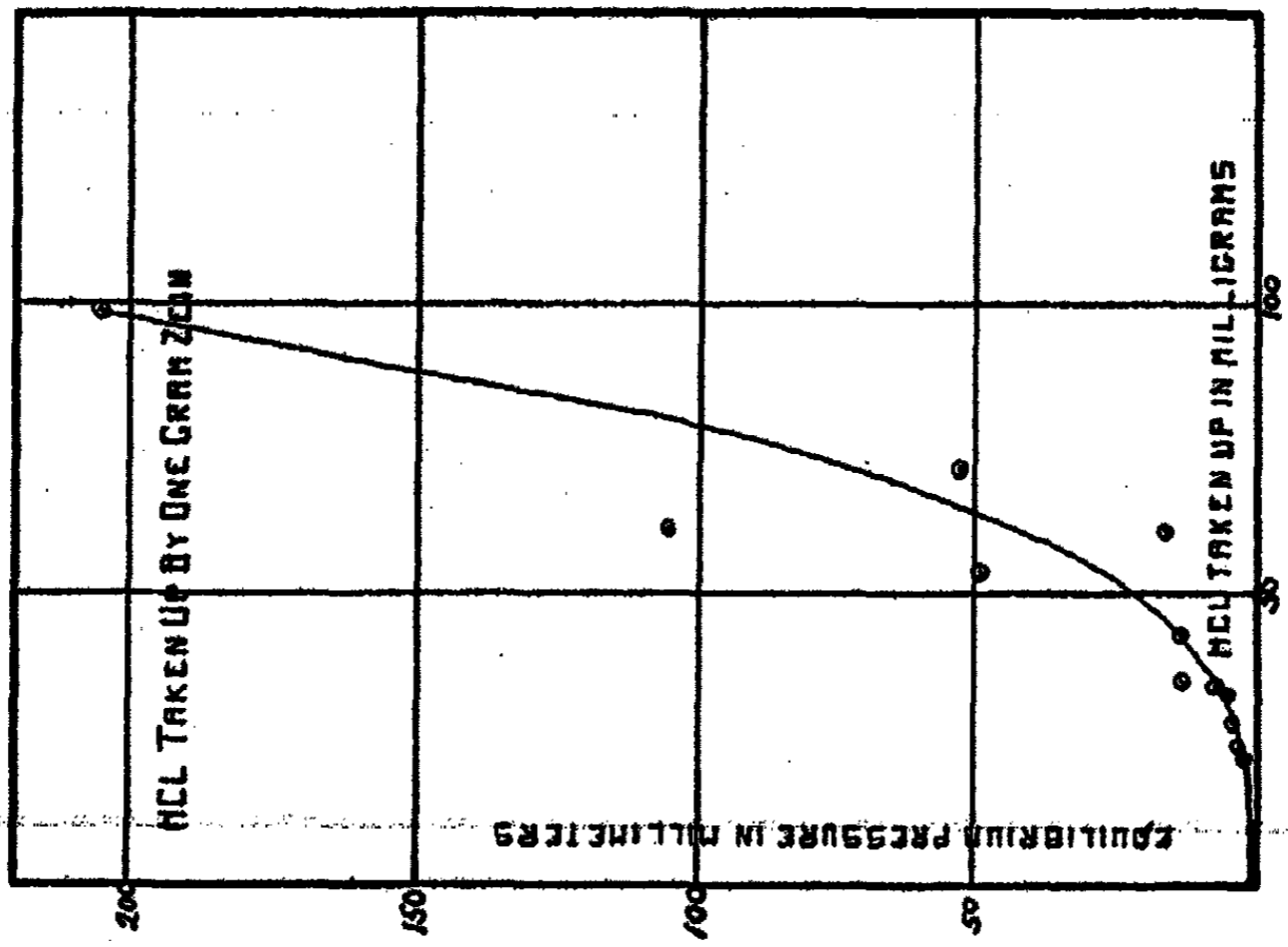

FIG. 23

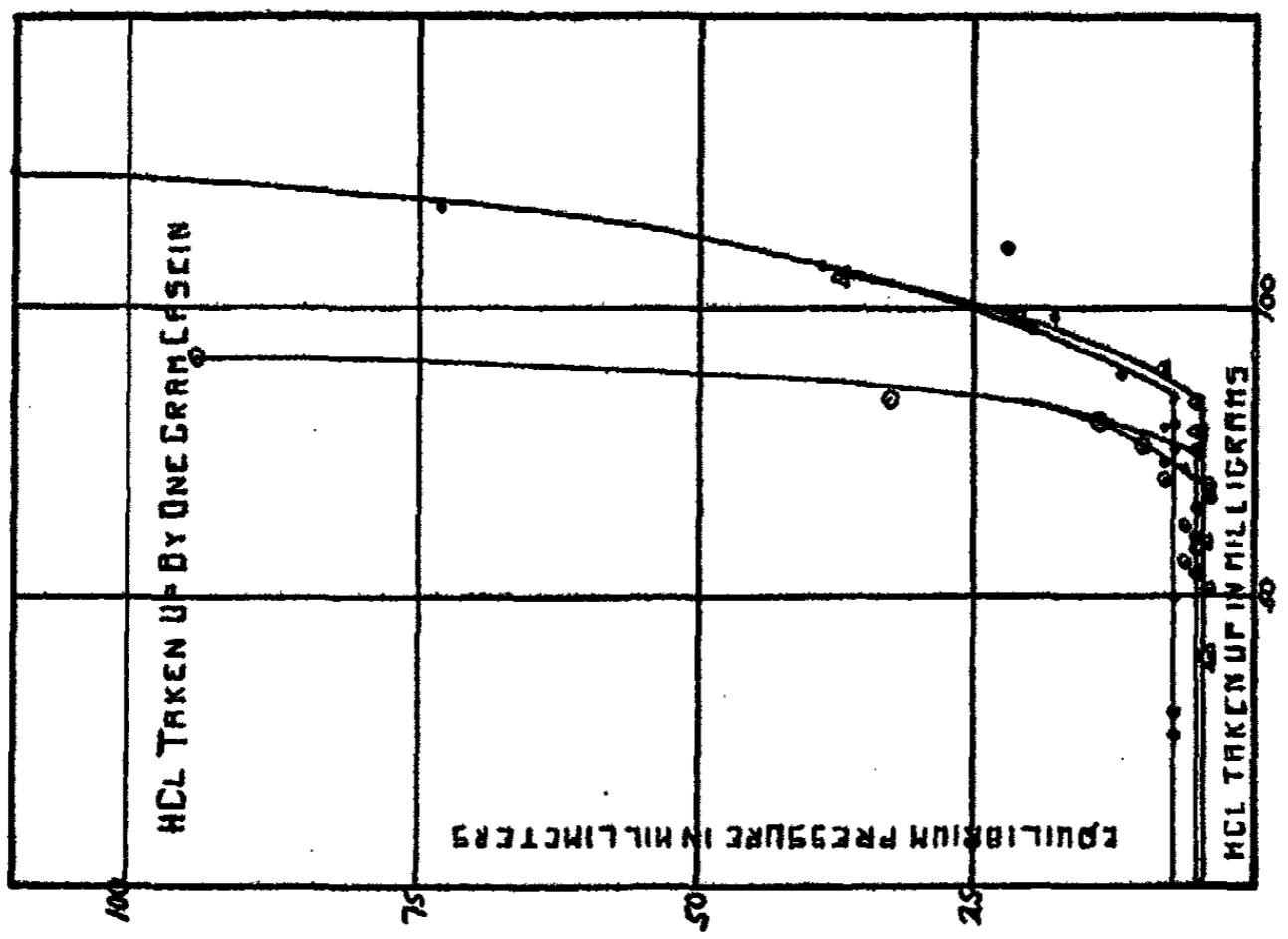

FIG. 22

TABLE XV  
Arachin and Hydrogen Chloride  
Sample = 1.2 grams

Vol. HCl added cc.	Vol. HCl removed cc	Net volume cc	Volume remaining cc	P <sub>2</sub> mm.	Volume taken up cc	Wt. HCl taken up mgm.	Wt. HCl taken up per gm. mgm.
71		71	1	6	70	115	96
84		155	20	96	135	221	184
	28	127	8	38	119	195	163
	14	113	4	19	109	179	149
	12	101	7	17	97	159	132
	6	95	2	7	93	152	127
	6	89	2	7	87	143	119
	6	83	2	7	81	133	111
	4	79	1.5	6	77.5	127	106

Fibrin and Hydrogen Chloride  
Sample = 1.56 grams

49		49	1.5	6	47.5	77.9	49.9
72		121	11	50	110	180	116
81		201.5	35	165	166.5	273	175
	44	157.5	14.5	58	143	234	150
	20	137.5	6	27	131.5	216	138
	12	125.5	3.5	16	122	200	128
	14	111.5	4	18	107.5	176	113
	8	103.5	2.5	11	101	166	106
	6	97.5	2	8	95	156	100
	5	92.5	1.5	7	91	149	95.6
	6	86.5	2	8	84	138	88

TABLE XVI  
Gliadin and HCl  
Sample = 3.99 grams

Vol. HCl added cc	Vol. HCl removed cc	Net volume cc	P <sub>2</sub> mm.	Volume remaining cc	Volume taken up cc	Wt. HCl taken up mgm.	Wt. HCl taken up per gm. mgm.
86	2	84	4		84	138	35
82	7	159	5	1	158	261	67
80	6	233	9	2	231	379	97
	5	228	8	2	226	370	95
	5	223	8	2	221	362	93
87	22	288	12	3	285	467	120
	8	280	12	3	277	454	116
	5	275	8	2	273	447	115
55	8	322	12	3	319	522	134
	18	304	12	3	301	493	127

TABLE XVI (Continued)

Vol. HCl added cc	Vol. HCl removed cc	Net volume cc	P <sub>1</sub> mm.	Volume remaining cc	Volume taken up cc	Wt. HCl taken up mgm.	Wt. HCl taken up per gm. mgm.
62	38	328	12	3	325	533	137
	8	320	12	3	317	520	133
167		487	127	27	460	754	193
	50	437	65	14	423	693	178
	28	409	38	8	401	657	169
	20	389	26	6	383	628	161
	14	375	20	4	371	608	156
	10	365	14	3	362	593	152
	9	356	13	3	353	579	147
	8	348	12	3	345	565	141
	8	340	12	3	337	552	141

TABLE XVII

Casein and Hydrogen Chloride

Sample = 3.5 grams

Vol. HCl added cc	Vol. HCl removed cc	Total Vol. HCl cc	P <sub>1</sub> mm.	Vol. HCl remaining cc	Vol. HCl taken up cc	Wt. HCl taken up mgm.	Wt. HCl taken up per gm. mgm.
79			25	10	69		
	10	69	7	3	65	106	30
	10	59	7	3	55	90	26
83		142	28	11	131	215	75
	20	122	12	5	113	185	53
	10	112	7	4	108	177	50
88		183	11	8	175	287	82
	12	171	8	3	168	275	79
	12	159	8	3	156	256	73
84		243	39	15	228	374	107
	31	212	20	8	204	334	96
	19	193	12	5	188	308	88
	10	183	7	3	180	295	84
	10	173	7	3	170	278	79.6
	10	163	7	3	160	262	75
	8	155	6	2	153	251	71.6
76		231	47	19	212	347	99
77		308	110	44	262	429	123
84		392	239	104	288	472	135
	114	278	73	29	249	408	117
	34	244	22	9	235	385	110
	28	216	18	7	209	343	98
	24	192	17	6	186	305	87
	10	182	7	3	179	293	84
	10	172	7	3	169	277	79

TABLE XVII (Continued)  
Casein and Hydrogen Chloride  
Sample = 5.0 gms. Dried at 100°

Vol. HCl added cc	Vol. HCl removed cc	Net volume cc	P <sub>2</sub> mm.	Volume remaining mm.	Volume taken up cc	Wt. HCl taken up mgm.	Wt. HCl taken up per gm. mgm.
86	50	36	8	4	32		
416		452	300	125	327	506	107
	134	318	94	40	278	456	91
	48	270	33	13	257	421	84
	20	250	14	6	244	400	80
	14	236	10	5	231	379	76
	6	230	5	2	228	374	75
	11	219	8	4	215	352	70
	6	213	4	2	211	346	69
	6	207	4	2	205	336	67
	6	201	5	2	199	326	65
	8	193	6	3	190	311	62
	6	187	5	2	185	303	60
	6	181	5	2	179	293	58
	8	173	6	3	170	279	56

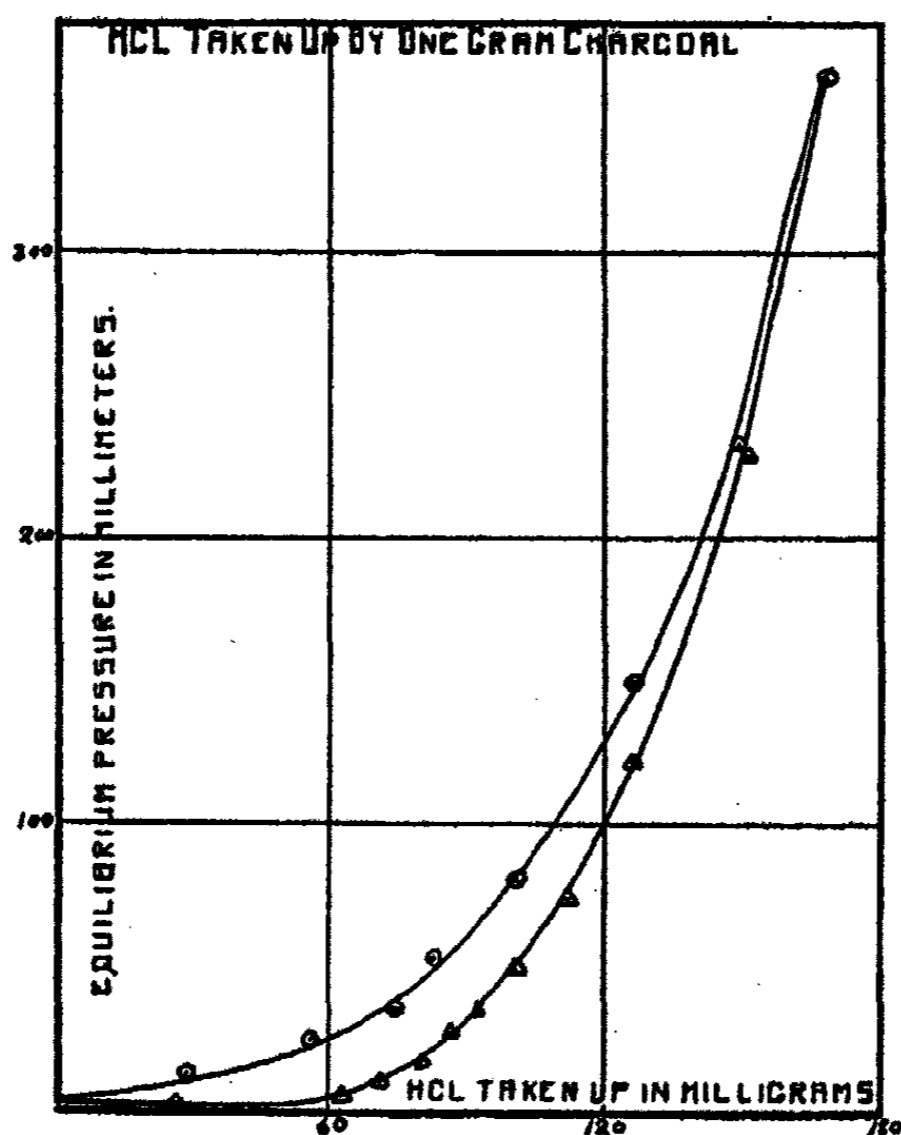

FIG. 24

TABLE XVII (Continued)  
Casein and Hydrogen Chloride  
Sample = 3.0 gms.

Vol. HCl added cc	Vol. HCl removed cc	Net volume cc	P <sub>2</sub> mm.	Volume remaining mm.	Volume taken up cc	Wt. HCl taken up mgm.	Wt. HCl taken up per gm. mgm.
77.5	2	75	4	1	74	121	40
	2	73	4	1	72	115	39
	2	71	4	1	70	115	38
82.3	48	106	5	1	105	174	58
	7	99	5	1	98	161	54
	5	94	4	1	93	153	51
84	12	166	8	2	164	269	89
	14	152	5	1	151	248	83
	9	143	5	1	142	233	78

TABLE XVIII  
Charcoal and Hydrogen Chloride  
Sample =

Vol. HCl added cc	Vol. HCl removed cc	Net volume cc	P <sub>2</sub> mm.	Volume remaining cc	Volume taken up cc	Wt. HCl taken up mgm.	Wt. HCl taken up per gm mgm.
88		88	12	3	85	139	28
90		178	24	6	172	282	56
87		265	53	11	254	416	83
	26	239	35	8	231	378	75.6
87		326	80	17	309	506	101
89		415	150	32	383	628	126
87		502	233	49	453	742	148
87		589	361	75	514	842	168
89		678	471	97	581	952	190
	174	504	229	48	456	747	149
	92	412	122	28	386	633	126
	56	356	74	16	340	557	112
	38	318	50	11	307	503	101
	26	292	35	8	284	465	93
	20	272	27	6	266	436	87
	26	246	17	4	242	397	79
	25	221	10	2	219	359	72
	28	193	5	1	192	315	63
	113	80	0.5	—	80	131	26

TABLE XVIII (Continued)  
Zein and Hydrogen Chloride  
Sample = 1.3980 grams

Vol. HCl added cc	Vol. HCl removed cc	Net volume cc	P <sub>2</sub> mm.	Volume remaining cc	Volume taken up cc	Wt. HCl taken up mgm.	Wt. HCl taken up per gm. mgm.
65		65	49	19	46	75	54
	22	43	13	6	37	61	43
	11	32	7	3	29	48	34
	6	26	4	2	24	39	28
	4	22	3	1	21	33	24
	2	20	2	1	19	31	22
74		94	106	42	52	85	61
72		166	205	82	84	138	98.5
	84	82	53	21	61	100	71.5
	24	58	16	6	52	85	61
	28	30	5	2	28	46	32.8

Sample = 3.089 grams

70		70	13	5	65	107	35
----	--	----	----	---	----	-----	----

12. The number of nitrogen atoms in the gliadin molecule which react stoichiometrically with hydrogen chloride is a multiple of nine.

13. Zein does not form a chemical compound with hydrogen chloride. It is also unaffected by contact with hydrogen chloride.

14. The other proteins are discolored by the hydrogen chloride. The amount of discoloration seems to depend on the partial pressure of the hydrogen chloride, the length of time which the protein is in contact with the gas, and the nature of the protein itself.

Our heartiest thanks are given to Professor P. A. Gortner of the University of Minnesota for his helpful courtesy in furnishing samples of highly-purified arachin, edestin, fibrin, gliadin, and zein.

*Cornell University.*

# VAPOR PRESSURES OF SOLUTIONS AND THE RAMSAY-YOUNG RULE. APPLICATION TO THE COMPLETE SYSTEM WATER-AMMONIA

BY F. C. KRACEK

Aside from approximation methods based on the laws of dilute solutions, there exists no method that will deal comprehensively with the relation between the vapor pressure and composition for concentrated solutions, whether they be saturated, unsaturated in the ordinary sense, or liquid mixtures, i.e., solutions at temperatures above the highest melting point in the system. It has early been recognized that the laws of ideal or dilute solutions do not apply to concentrated solutions. Repeated attempts to derive a satisfactory expression for their behavior by modifying the dilute solution laws have to date resulted in failure; in other directions, attempts to account for the abnormal behavior of concentrated solutions on the basis of association or of compound formation in solution have likewise added little that is useful. In view of these facts it remains necessary to treat the effect of composition in an empirical manner, and to seek to eliminate the effect of temperature by evolving a rational method that will reduce all experimental data to a common basis (common isotherm or a common isobar) for which the empirical relation between composition and some thermodynamic function of vapor pressure can be established.

The method described in the following pages is based on the Ramsay-Young rule, and, as we shall see later, is thermodynamically sound. The method developed is not particularly simple, and while this may appear to be a serious objection, we may be reminded that no simple method will completely describe the behavior of solutions of all concentrations over a great range of temperature. It is presented in the hope that it may prove to be useful in dealing with the effect of temperature and composition on the vapor pressure of solutions.

The vapor pressure-temperature relationship at constant composition offers no theoretical difficulties. Two methods in general are available for this purpose. One is the usual logarithmic vapor pressure formula originally proposed in a simple form by Kirchhoff; the other, less well known, consists in comparing the temperatures at which the substance or solution under investigation and some other reference substance exert equal vapor pressures; as such, it is essentially a boiling point law.

The logarithmic vapor pressure formula

$$\log p = A/T + B \log T + \dots + I \quad (1)$$

does not lend itself particularly well to the study of vapor pressures of solutions of varying compositions, for while it is comparatively easy to determine its constants for any one given composition, the change of these con-

stants with composition leads to such cumbersome computation that a simpler method is preferable.

The simplest alternative is the boiling point relation proposed by Dühring,<sup>1</sup> which states that the difference between the temperatures at which a substance A exerts the vapor pressures  $p_1$  and  $p_2$  is a constant multiple of the difference between the temperatures at which a second substance B exerts the same vapor pressures, that is,

$$(t_2 - t_1)_A = m(t_2 - t_1)_B, \quad (2)$$

or, in absolute temperatures,

$$T_A = T_0 + mT_B. \quad (2')$$

The usefulness and some of the limitations of this rule have been discussed at length by von Rechenberg<sup>2</sup> (who, incidentally, has been led by its use to propose the somewhat questionable concept of the zero-point of vaporization). The application of this rule to solutions has been studied by Badger and co-workers,<sup>3</sup> Mollier,<sup>4</sup> Wilson,<sup>5</sup> and others. It is useful for small ranges of vapor pressure, particularly for chemically related substances. The linear relation of the Dühring rule fails to hold over extended ranges of vapor pressure; this shows that a higher power equation is needed. Such an equation is supplied by the Ramsay-Young rule.

The relation proposed by Ramsay and Young<sup>6</sup> states that the ratio of the absolute boiling points of two substances A and B at various vapor pressures varies linearly with temperature. This may be expressed by the equations

$$(T_A/T_B)_p = (T_A/T_B)_{p_0} + c(T - T_0)_B$$

or

$$R' = R'_0 + c(T - T_0)_B. \quad (3)$$

The thermodynamic basis of this generalization has been discussed among others by Porter<sup>7</sup> and Johnston,<sup>8</sup> the rule can easily be shown to follow directly from the logarithmic vapor pressure formula. It is essentially a power series boiling point equation, with all powers beyond the second neglected.

#### The Ramsay-Young Rule for Solutions

Consider a binary system composed of the substances A and B. To apply the Ramsay-Young rule, select one of these (B), as the reference substance. In the region of liquid mixtures, depending upon whether the boiling

<sup>1</sup> Dühring: "Neue Grundgesetze zur rationellen Physik und Chemie" (1878).

<sup>2</sup> von Rechenberg: several papers in *Z. physik. Chem.*, and the book, "Die einfache und fraktionierte Destillation in Theorie und Praxis," Leipzig (1923); this author has employed the Dühring rule exclusively in tabulating the vapor pressures of nearly 500 substances.

<sup>3</sup> Baker and Waite: *Chem. Met. Eng.*, 25, 1137, 1174 (1921); Badger: 27, 932 (1922); Carr, Townsend and Badger: *Ind. Eng. Chem.*, 17, 643; Leslie and Carr: 810 (1925).

<sup>4</sup> Mollier: *Forschungsarbeiten a. d. Geb. Ingenieurwesen*, 63, 85 (1909).

<sup>5</sup> Wilson: *Eng. Expt. Sta., Univ. Illinois, Bull.* 146 (1925).

<sup>6</sup> Ramsay and Young: *Phil. Mag.*, 20, 515 (1885); 21, 33, 135; 22, 32, 37 (1886).

<sup>7</sup> Porter: *Phil. Mag.*, 13, 724 (1907).

<sup>8</sup> Johnston: *Z. physik. Chem.*, 62, 330 (1908).



points of the solutions under a given standard pressure gradually increase, decrease, pass thru a maximum or a minimum on passage from the boiling point of the reference substance to the boiling point of the other component of the solution, the ratio of the two absolute boiling points will also correspondingly increase, decrease, or pass thru a maximum or a minimum. At other pressures the boiling point ratios of individual solutions of constant composition will alter by an amount dependent upon the slope  $c$  of each individual Ramsay-Young line for the particular composition. Hence the problem is resolved into the relatively simple procedure of determining (a) the value of the absolute boiling point ratio for some standard pressure at various compositions, and (b) the change in the slope of the boiling point ratios with changes of composition. The advantage of the use of the Ramsay-Young rule lies principally in the fact that as a two-constant formula it is capable of reproducing a much greater range of vapor pressure than any other equation of comparable simplicity.

#### Application to the System Water-Ammonia

To illustrate concretely the method briefly described above we have selected the system  $H_2O-NH_3$  as the most suitable. This system has been studied extensively from the experimental standpoint, in view of its undoubted theoretical as well as practical importance. The boiling points (or the vapor pressures) in the system vary gradually from one component to the other without passing thru either a maximum or a minimum, thus partly simplifying the calculations. Furthermore, the solubilities and vapor pressures of saturated solutions have been determined. These serve as a valuable check on the correctness of the values calculated for the liquid mixtures.

The total pressures of aqueous solutions of ammonia have been studied by Carius,<sup>1</sup> Roscoe and Dittmar,<sup>2</sup> Sims,<sup>3</sup> Watts,<sup>4</sup> Wachsmuth,<sup>5</sup> Raoult,<sup>6</sup> Doyer,<sup>7</sup> and Perman<sup>8</sup> at  $0^\circ C$  and higher temperatures. Mallet<sup>9</sup> made a few measurements between  $-3.9^\circ$  and  $-40^\circ C$ . More recently Smits and Postma<sup>10</sup> made an extensive study of the system at low temperatures, measuring vapor pressures up to approximately 1 atm., including those of saturated solutions. Mollier<sup>11</sup> made measurements up to about 10 atm. over an extended range of composition. Further recent measurements of the vapor pressures of liquid

<sup>1</sup> Carius: Ann., 99, 129 (1856).

<sup>2</sup> Roscoe and Dittmar: Ann., 110, 140 (1859); 112, 327 (1859).

<sup>3</sup> Sims: Ann. 118, 333 (1861).

<sup>4</sup> Watts: Ann. Suppl., 3, 227 (1864).

<sup>5</sup> Wachsmuth: Arch. Pharm., (3) 8, 510 (1878).

<sup>6</sup> Raoult: Ann. Chim. Phys. (5), 1, 262 (1874).

<sup>7</sup> Doyer: Z. physik. Chem., 6, 486 (1890).

<sup>8</sup> Perman: J. Chem. Soc., 79, 718 (1901); 83, 1168 (1903).

<sup>9</sup> Mallet: Ann. Chem. J., 19, 804 (1897).

<sup>10</sup> Smits and Postma: Proc. Acad. Sci. Amsterdam, 17, 187 (1914); Postma: Rec. Trav. chim., 39, 515 (1920).

<sup>11</sup> Mollier: Forschungsarbeiten a.d. Geb. Ingenieurwesen, 63, 85 (1909).

mixtures of water and ammonia are due to Wilson<sup>1</sup> whose data unfortunately do not agree at all well with those of other investigators, especially in the region of lower pressures. Mittasch, Kuss and Schlueter<sup>2</sup> have also made some measurements above 0°C., of indifferent accuracy. The principal series of data of good mutual agreement are those of Perman, Smits and Postma, and of Mollier. Our calculations are based mainly on the work of the latter investigators. The other data quoted were used as confirmatory checks rather than as fundamental data.

Beside the above-quoted series of measurements of total vapor pressures, partial vapor pressure data due to Gaus,<sup>3</sup> Abegg and Riesenfeld,<sup>4</sup> Locke and Forssall,<sup>5</sup> Perman,<sup>6</sup> Neuhausen and Patrick,<sup>7</sup> and Wilson are available.

Solubilities have been measured by Rüdorff,<sup>8</sup> Guthrie,<sup>9</sup> Pickering,<sup>10</sup> Rupert,<sup>11</sup> Smits and Postma,<sup>12</sup> and Elliot,<sup>13</sup> with the result that two compounds,  $2\text{NH}_3 \cdot \text{H}_2\text{O}$  and  $\text{NH}_3 \cdot \text{H}_2\text{O}$  have been found to exist in the solid state.

The vapor pressure curves for ammonia and water are known with great exactness.<sup>14</sup> This is of importance in that it lends security to the calculations on solutions.

The correlation of the above mass of data by means of the Ramsay-Young rule is given in the subsequent pages. A critical test for its accuracy is found in the agreement of the derived and observed vapor pressure curves for the saturated solutions.

It is necessary to adopt certain conventions in the numerical work to follow. These conventions are more or less arbitrary; they depend upon the nature and fundamental constants of the system under consideration.

Ammonia has been selected as the reference substance B in the equation of the Ramsay-Young rule (equation 3). Since  $\text{H}_2\text{O}$  exerts lower vapor pressures than  $\text{NH}_3$ , and the vapor pressures of the solutions are always intermediate between those of the two components, the value of the boiling point ratio  $R'$  in the above-mentioned equation, equal to one for pure  $\text{NH}_3$ , is always greater than one for the rest of the system.

Subtracting one from  $R'$  we have

$$R' - 1 = R = (T_A/T_B) - 1 = (T_A - T_B)/T_B, \quad (4)$$

<sup>1</sup> Wilson: Eng. Expt. Sta., Univ. Illinois, Bull. 146 (1925).

<sup>2</sup> Mittasch, Kuss and Schlueter: Z. anorg. allgem. Chem., 159, 1 (1926).

<sup>3</sup> Gaus: Z. anorg. Chem., 25, 236 (1900).

<sup>4</sup> Abegg and Riesenfeld: Z. physik. Chem., 40, 84 (1902); 45, 462 (1903).

<sup>5</sup> Locke and Forssall: Am. Chem. J., 31, 268 (1904).

<sup>6</sup> Perman: J. Chem. Soc., 83, 1168 (1903).

<sup>7</sup> Neuhausen and Patrick: J. Phys. Chem., 25, 693 (1921).

<sup>8</sup> Rüdorff: Pogg. Ann., 116, 55 (1862).

<sup>9</sup> Guthrie: Phil. Mag., 18, 22, 205 (1884).

<sup>10</sup> Pickering: J. Chem. Soc., 63, 141 (1891).

<sup>11</sup> Rupert: J. Am. Chem. Soc., 31, 866 (1909); 32, 748 (1910).

<sup>12</sup> Smits and Postma: op. cit.

<sup>13</sup> Elliot: J. Phys. Chem., 28, 887 (1924).

<sup>14</sup> Cragoe, Meyers and Taylor: Vapor Pressure of Ammonia, Bur. Standards Sci. Paper No. 369 (1920); J. Am. Chem. Soc., 42, 206 (1920). The vapor pressure data on water were taken from the 5th ed. of Landolt-Börnstein Tabellen; compare Washburn's tabulation in the 3rd volume of the International Critical Tables.

or, the symbol  $R$  has the significance of the relative boiling point elevation. As we shall see later, this is more useful for this particular case than the boiling point ratio.

$R_0$  has been selected as the value of  $R$  at the vapor pressure corresponding to that of pure  $\text{NH}_3$  at  $250^\circ\text{K}$  (1241 mm Hg). This value lies approximately

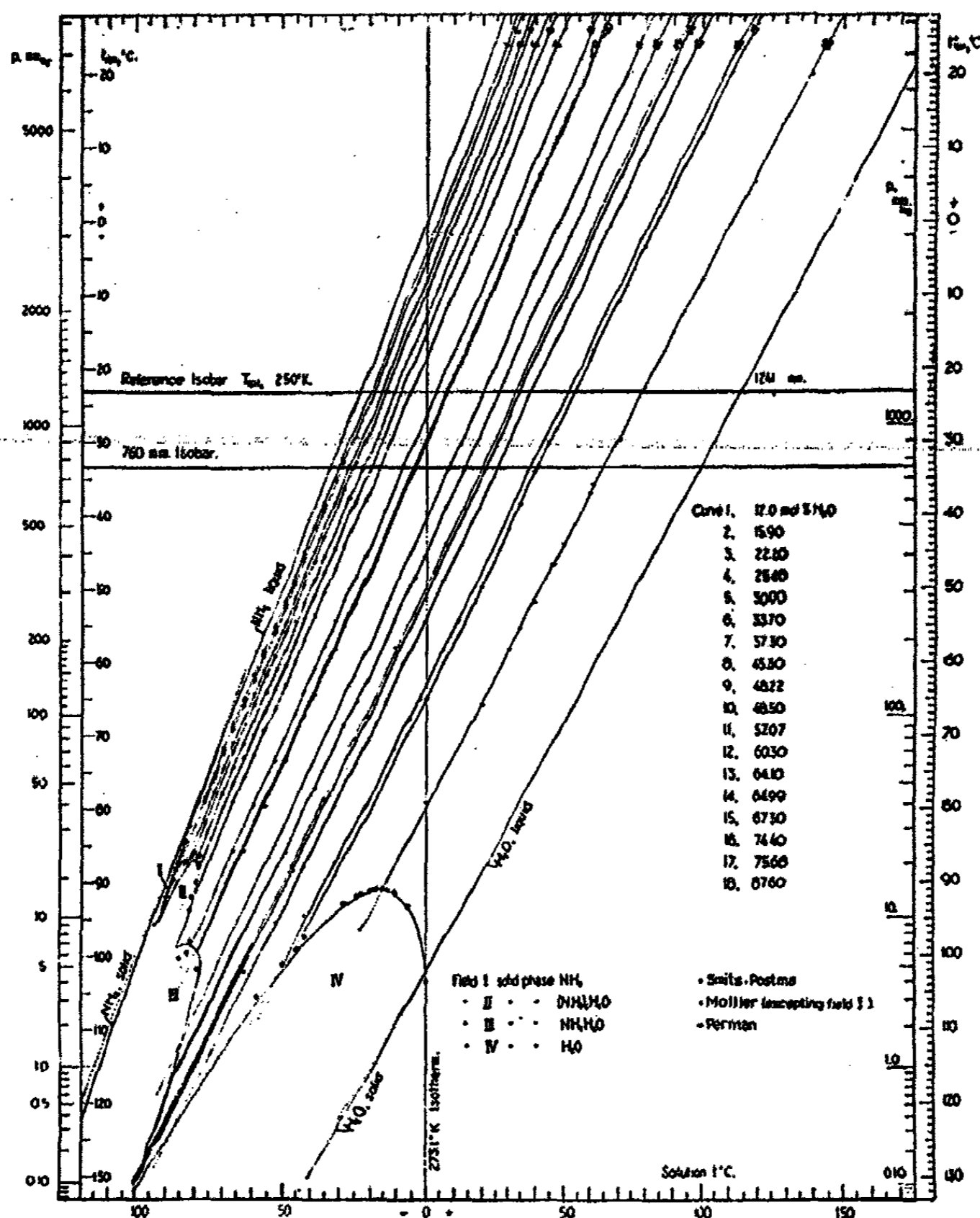

FIG. 1  
 Dühring type vapor pressure diagram for the system  $\text{NH}_3 - \text{H}_2\text{O}$

midway of the logarithmic range of the vapor pressures covered by the experimental data, and the temperature  $250^\circ\text{K}$  rather than that corresponding to 1 atm. pressure ( $239.75^\circ\text{K}$ ) has been selected purely for convenience in calculation.

Compositions are expressed in mol fraction or mol per cent of water for theoretical reasons. Since the molecular weights of  $\text{NH}_3$  and  $\text{H}_2\text{O}$  are not

greatly different, this convention does not impair the use of the results for practical purposes.<sup>1</sup>

Graphical representation of the system is given in Figs. 1 and 2, by means of the Dühring rule and the Ramsay-Young rule, respectively. The construction of the diagrams is obvious, but to remove all possibilities of am-

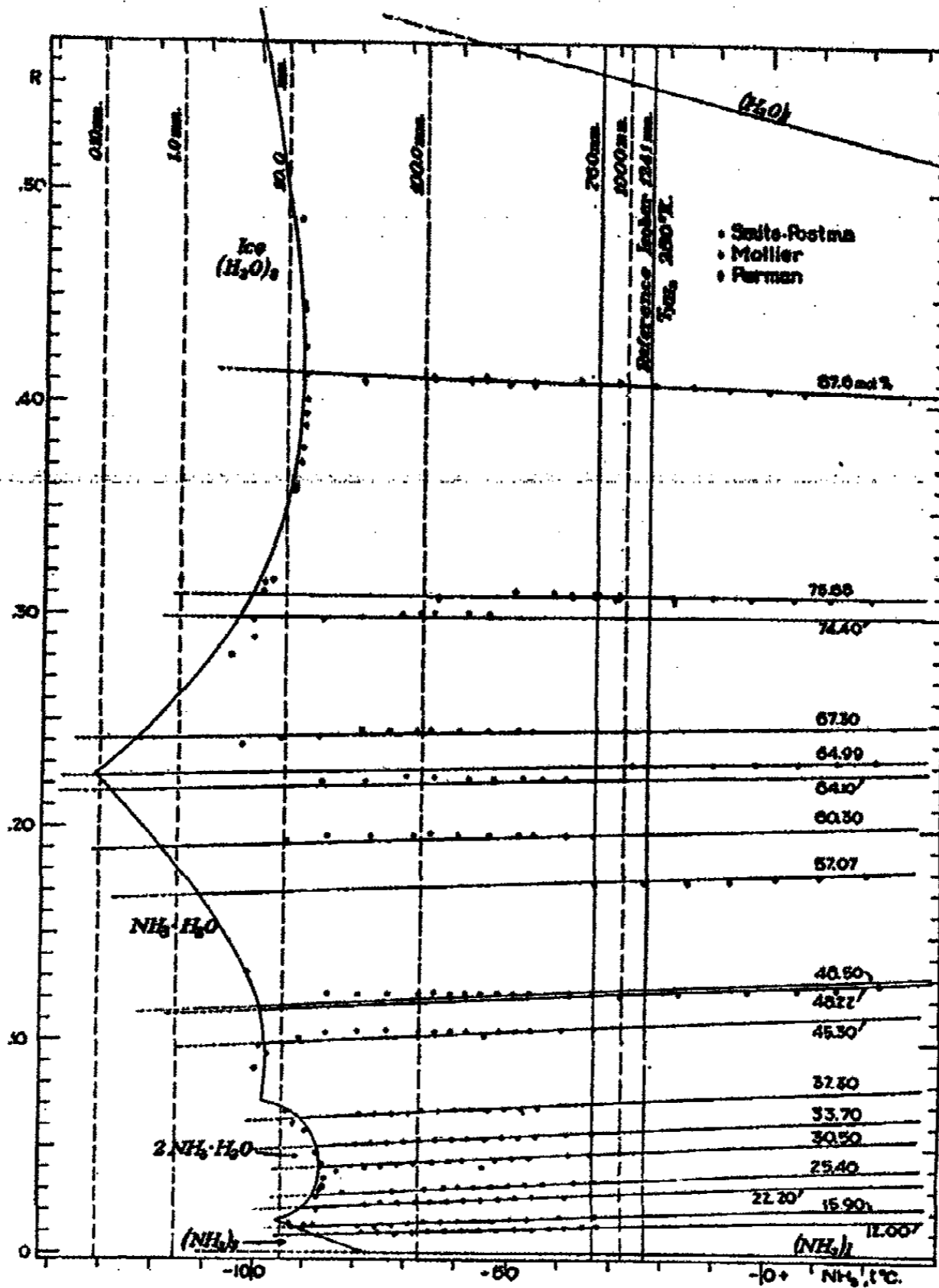

FIG. 2  
Ramsay-Young diagram for the system  $\text{NH}_3\text{-H}_2\text{O}$ .

<sup>1</sup> The conversion from mol to weight per cent in this case is greatly facilitated by constructing a plot of the difference between the two along the ordinate against mol per cent along the abscissa. This difference never exceeds 1.42 per cent. For convenience in constructing the plot use may be made of the equation

$$W_A - N_A = 0.05827 N_A - 0.05827 N_A^2 - 0.0034 N_A^3$$

$W_A$  and  $N_A$  signifying the weight and mol fraction of water in solution, respectively. This approximation equation can be readily derived from the relation between compositions expressed in weight and mol fractions.

biguity in interpretation, a brief description of the procedure may not be amiss. Suppose that a given solution exerts a vapor pressure  $p$  at the temperature  $t^{\circ}\text{C} = T^{\circ}\text{K}$ . Let the temperature at which pure  $\text{NH}_3$  exerts the same vapor pressure  $p$  be  $t_B^{\circ}\text{C} = T_B^{\circ}\text{K}$ . In the Dühring diagram we simply plot the two temperatures against each other, i.e.,  $t_s$  vs.  $t_B$ . To establish the same point in the Ramsay-Young diagram, the ratio  $T_s/T_B$  is calculated, and its value  $R'$ , or the corresponding value of  $R = R' - 1$  is plotted against either  $t_B$  or  $T_B$ . Repeating this procedure for various values of the vapor pressure of a given solution of constant composition, the constant composition Dühring or Ramsay-Young line is established. As will be seen from Fig. 2, the slopes of the Ramsay-Young lines vary with com-

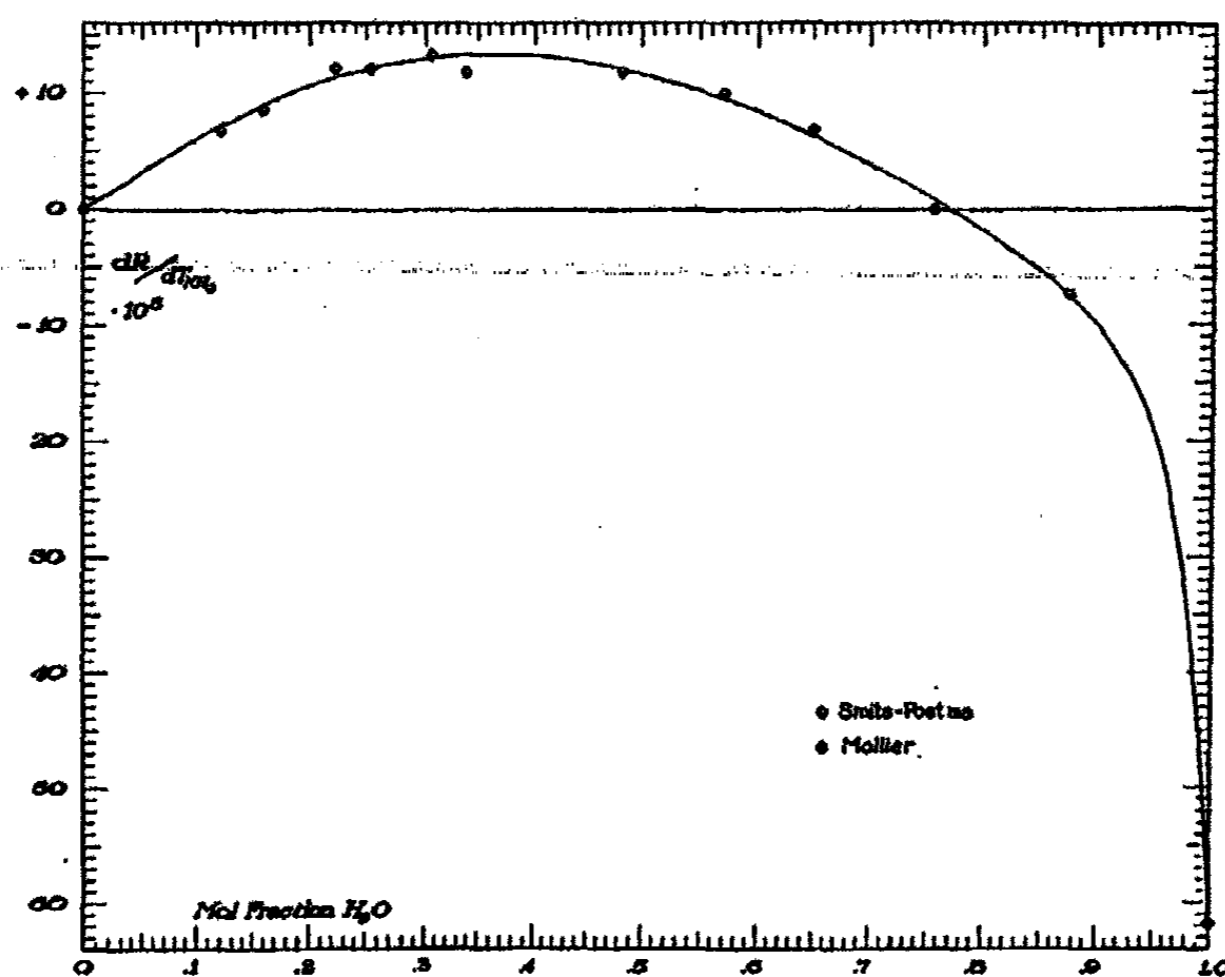

FIG. 3

Plot of the slopes of the Ramsay-Young lines for the system  $\text{NH}_3\text{-H}_2\text{O}$  vs. composition.

position; the same is true, of course, of the Dühring lines, the latter, however, are curved quite noticeably, whereas the former are straight lines within experimental error. In this system the Ramsay-Young line for  $\text{H}_2\text{O}$  exhibits the greatest slope; the slopes of the lines for solutions vary considerably, and differ greatly from the ideal slopes, which necessarily should be directly proportional to the composition expressed in mol fractions. This abnormality in the values of the slopes is to be expected from the nature of the system, which is far from being ideal. It is interesting to note in anticipation that the change of slope with composition,  $dc/dN$  is zero at about 36 mol per cent of  $\text{H}_2\text{O}$ , corresponding roughly to the composition  $2\text{NH}_3\cdot\text{H}_2\text{O}$  instead of to  $\text{NH}_3\cdot\text{H}_2\text{O}$ , the compound ordinarily assumed to exist in aqueous solutions of ammonia.



### Determination of the Slopes of the Ramsay-Young Lines

From the various series of experimental data on the vapor pressures of aqueous ammonia solutions, the values of  $R$  were calculated and tabulated for each well established constant composition. To save space these tabulations are not reproduced; the calculations were carried out with considerable

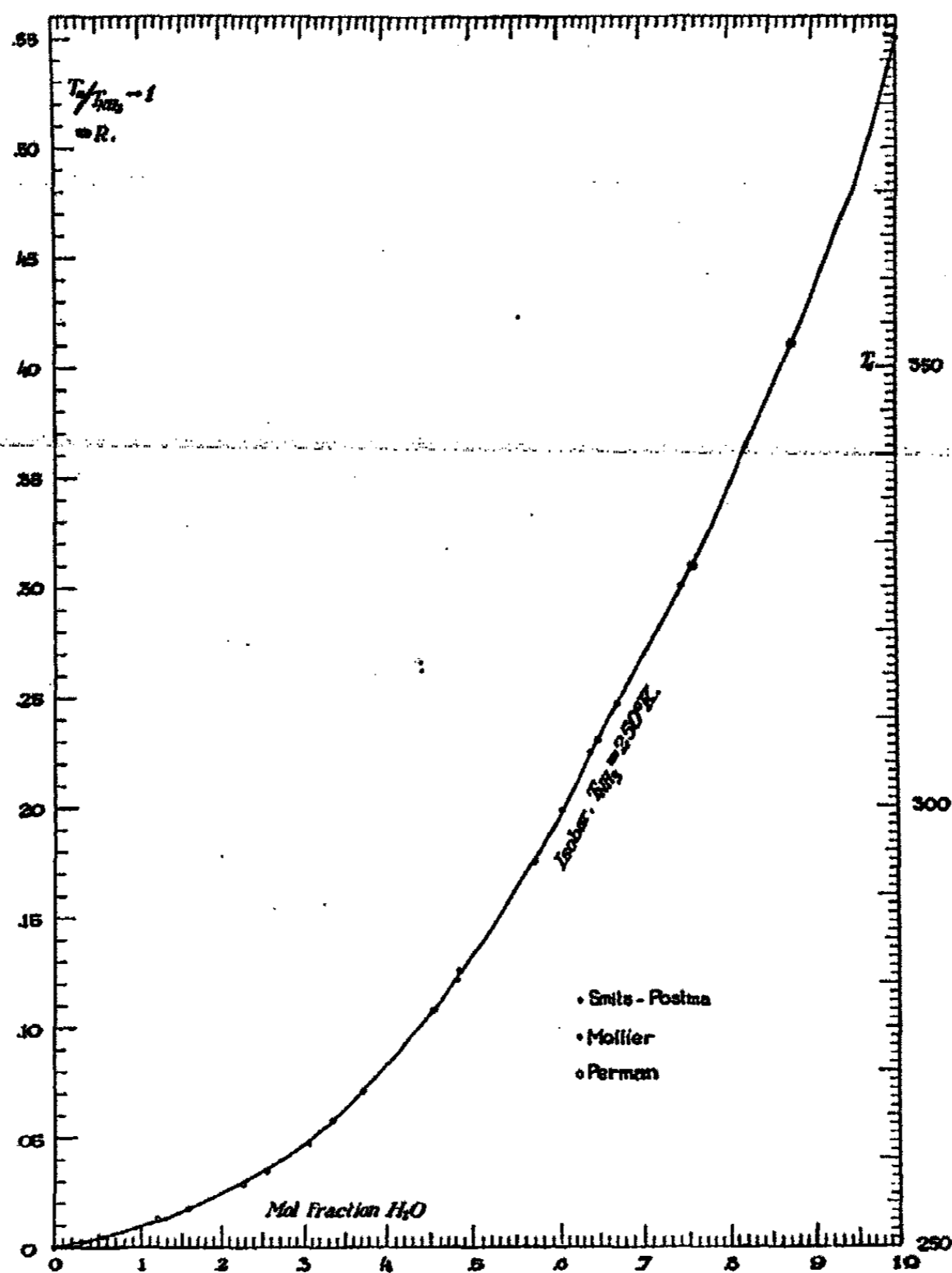

FIG. 4

The standard boiling point curve for the system  $\text{NH}_3\text{-H}_2\text{O}$  at 1241 mm. Hg ( $T_{\text{NH}_3} = 250^\circ\text{K}$ )

care, using the previously quoted Bureau of Standards vapor pressure data for  $\text{NH}_3$  as reference. The slope for each constant composition line was determined from a large scale graph of  $R$  against the temperature of  $\text{NH}_3$ , yielding the value of  $c$  in the formula of the Ramsay-Young rule for that composition of solution. The various values of  $c = dR/dT_B$  were then plotted against the composition expressed in mol fractions of  $\text{H}_2\text{O}$ , as shown

in Fig. 3. The resulting smooth curve can not be expressed conveniently by a simple algebraic expression; the values of the slope were therefore read off from the smooth curve and tabulated in Table I for convenient reference. The value of  $c$  for  $H_2O$  in terms of  $NH_3$  temperatures ( $dc/dT_B$ ) varies slightly, but not sufficiently to introduce an appreciable error if it is assumed to be constant over the range of pressures covered by the data. We have assumed therefore that the slope for each constant composition of solution is constant.

#### Variation of $R_0$ with Composition

As has already been mentioned, the standard reference pressure corresponding to the vapor pressure of  $NH_3$  at  $250^\circ K$  has been selected for the calculation of  $R_0$ . This gives us the expression for the Ramsay-Young rule in the form

$$R = R_0 + c(T - 250)_B \quad (5)$$

Knowing the value of  $c$  in the above equation from Table I, we can calculate the value of  $R_0$  for each experimental point. When this is done for the various solutions the result is a series of values of  $R_0$  which, when plotted against composition of the solutions, yields a curve reproduced in Fig. 4. Since  $T_s = R'T_B$ , and  $T_B = 250$  for  $R_0$ , this curve also represents the variation of the boiling points (at the standard reference pressure) of the solutions with composition; the curve may be termed the standard boiling point curve, or the standard isobar.

The standard isobar of Fig. 4 can be expressed with good approximation by means of a fourth degree equation; a more usable expression is obtained, however, if we employ the simple device of plotting the  $\log(R_0 \pm k)$  against  $\log N_A$  ( $N_A =$  mol fraction of  $H_2O$  in solution), as shown in Fig. 5. The equation of the straight line is

$$\log(R_0 - 0.0070)_{\text{calc.}} = 2.1394 \log N_A + 9.73465 - 10 \quad (6)$$

This equation brings out the advantage of using  $R$  instead of  $R'$  in the computations. Both  $R$  and  $N_A$  are zero for pure  $NH_3$ , hence the logarithmic plot can be used to obtain a straight line that will at least approximately represent the relation between these two quantities. The same result of course would be obtained by setting  $k = 1.0070$  and using  $R'_0$ , but the relationship then would not be quite so obvious.

Inspection of Figs. 4 and 5 shows that the values of  $R_0 - k$  for the experimental points equalized by equation (5) fall quite near the straight line in all cases; in order to prevent any actual departure from the straight line from being overlooked, a deviation curve of Fig. 6 has been obtained, and the values of the deviations tabulated in Table II. These deviations are to be added to the calculated values of  $R_0 - k$ , that is,

$$R_0 = (R_0 - k)_{\text{calc.}} + \text{deviation.} \quad (7)$$

#### The Complete Pressure-Temperature-Composition Diagram for the System

The combined results of the above considerations enable us to calculate the vapor pressure of a solution of any composition at any given temperature



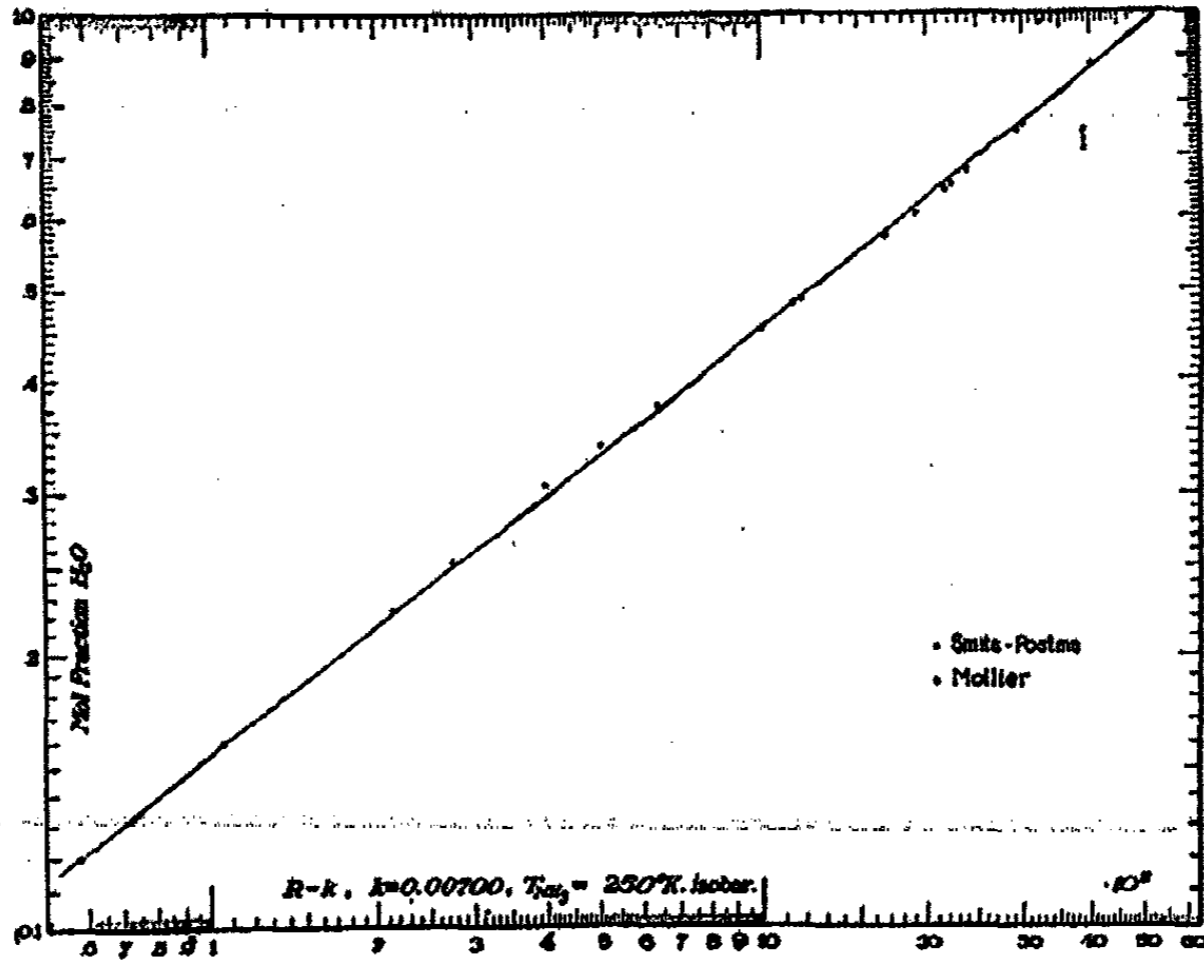

FIG. 5  
Logarithmic plot of the standard 1241 mm. Hg isobar

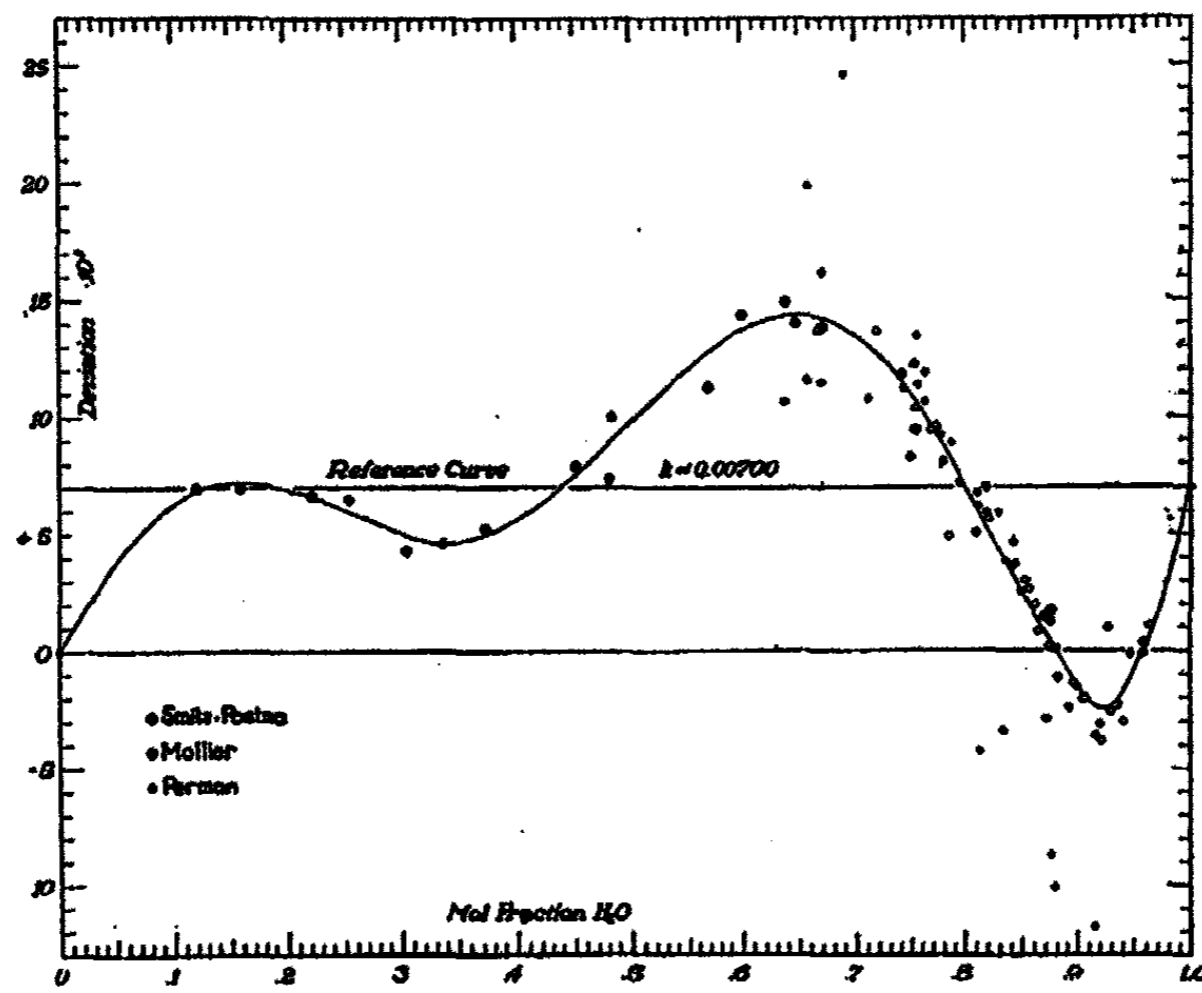

FIG. 6  
Deviation curve for  $R_0$  vs. composition (see equation 7).



within the range of the experimental results considered, namely, up to approximately 10,000 mm Hg. To be more exact, we should say that we calculate directly the boiling points of the solutions corresponding to any given pressure. For a solution whose composition is given by  $N_A$  we have:

$$\log (R_0 - k)_{\text{calc.}} = 2.1394 \log N_A + 9.73465 - 10 \quad (6)$$

$$R_0 = (R_0 - k)_{\text{calc.}} + \text{deviation (Table II)} \quad (7)$$

$$R = R_0 + c(T - 250)_B \text{ (Table I)} \quad (5)$$

$$R' = 1 + R \quad (4)$$

$$T_s = R' T_B \quad (3)$$

Since the value of the vapor pressure corresponding to  $T_s$  is the same as the vapor pressure of  $\text{NH}_3$  at  $T_B$ , it can be directly located by reference to the already quoted Bureau of Standards table of the values of the vapor pressure of  $\text{NH}_3$  upon which these calculations are based.

The complete results for the liquid mixtures of  $\text{H}_2\text{O}$  and  $\text{NH}_3$  have been calculated and arranged in Tables III and IV for vapor pressures up to the neighborhood of 10,000 mm Hg. For technical purposes extrapolation can safely be extended to higher pressures.

#### The Vapor Pressure Curve for Saturated Solutions

Since the vapor pressure of the saturated solution must be equal to the vapor pressure of a solution of the same composition at the same temperature even if the solid phase is not present (as in case of undercooling), the method outlined above must be able to yield the complete vapor pressure curve of saturated solutions of the system from a knowledge of the vapor pressures of the liquid mixtures and the temperatures and compositions along the solubility curve. This expectation is fulfilled with a good agreement between the calculated values and those obtained by Smits and Postma.<sup>1</sup>

The most reliable series of solubility data on this system are represented graphically in Fig. 7. The existence of two compounds in the solid state is indicated, namely,  $2\text{NH}_3 \cdot \text{H}_2\text{O}$  and  $\text{NH}_3 \cdot \text{H}_2\text{O}$ , whose melting points are  $-78.8$  and  $-79.2$  respectively. The melting point of pure  $\text{NH}_3$  is  $-77.6^\circ\text{C}$ . The eutectic between  $\text{NH}_3$  and  $2\text{NH}_3 \cdot \text{H}_2\text{O}$  is located at  $-93.0^\circ\text{C}$ , that between  $2\text{NH}_3 \cdot \text{H}_2\text{O}$  and  $\text{NH}_3 \cdot \text{H}_2\text{O}$  is at  $-86.4^\circ\text{C}$ . There is considerable uncertainty in the experimental results on the branch of the curve for the solubility of ice; the most probable temperature for the eutectic between  $\text{NH}_3 \cdot \text{H}_2\text{O}$  and ice appears to be that determined by Smits and Postma as  $-100.3^\circ\text{C}$ . Rupert states that this eutectic must lie below  $-120^\circ\text{C}$ ; the disagreement is most likely due to failure of the very viscous solutions to crystallize readily. The derived vapor pressure curve for the saturated solutions, together with the points directly determined by Smits and Postma will be found represented in Fig. 8, the lower left portion of Fig. 1, and in the left half of Fig. 2. The numerical values of the vapor pressures and compositions of the saturated solutions are given in Table V.

<sup>1</sup> Smits and Postma: *op. cit.*

TABLE III  
Boiling Points of  $\text{NH}_3\text{-H}_2\text{O}$  Solutions

mol % $\text{H}_2\text{O}$ mm Hg	Temperature °C.										
	0	5	10	15	20	25	30	35	40	45	50
10.0	-76.48	-75.89	-75.12	-74.13	-72.82	-71.06	-68.73	-65.67	-81.71	-77.47	-72.42
50.0	67.23	66.55	65.68	64.60	63.19	61.32	58.86	55.66	61.73	57.09	51.55
100.0	56.95	56.17	55.19	54.00	52.78	50.48	47.88	44.50	51.54	46.68	40.91
200.0	45.41	44.50	43.39	42.08	40.43	38.28	35.51	31.95	40.18	35.10	29.06
400.0	37.95	36.95	35.76	34.36	32.61	30.37	27.50	23.81	27.40	22.06	15.73
600.0	33.35	32.30	31.05	29.51	27.79	25.49	22.56	18.79	19.11	13.61	7.09
760.0	27.72	26.60	25.28	23.75	21.88	19.51	-16.49	-12.63	14.00	8.39	-1.75
1000.0	12.12	10.79	-9.28	-7.55	-5.48	-2.90	+0.35	+4.47	-7.73	-2.00	+4.77
2000.0	-1.89	-0.42	+1.23	+3.09	+5.31	+8.03	11.43	15.72	+9.68	+15.75	22.91
3000.0	+5.94	+7.52	9.29	11.26	13.57	16.41	19.92	24.35	21.13	27.42	34.84
4000.0	12.36	14.04	15.90	17.96	20.36	23.29	26.90	31.44	29.92	36.37	43.98
5000.0	17.86	19.62	21.57	23.70	26.19	29.20	32.89	37.52	37.13	43.73	51.49
6000.0	22.70	24.54	26.56	28.76	31.32	34.40	38.16	42.88	43.32	50.03	57.93
7000.0	27.02	28.93	31.01	33.28	35.90	39.04	42.88	47.67	48.77	55.59	63.60
8000.0	30.95	32.92	35.07	37.40	40.07	43.27	47.17	52.03	53.64	60.55	68.67
9000.0	34.58	36.61	38.82	41.20	43.93	47.19	51.14	56.06	58.08	65.07	73.28
10000.0									62.18	69.25	77.55

TABLE III (Continued)

mol % H <sub>2</sub> O p mm Hg	Temperature °C.										Calc.	Obs.				
	55	60	65	70	75	80	85	90	95	100						
0.10			-99.07													
1.0		-85.36	78.58	-73.48												
10.0	-67.46	60.82	54.37	47.57	-40.38	-33.06	-24.94									
50.0	46.14	38.89	31.86	24.46	14.62	-8.66	+0.15	+9.47	+20.79	+11.24						
100.0	35.27	27.71	20.39	-12.69	-4.53	+3.74	12.91	22.58	34.26	51.57						
200.0	23.17	15.27	-7.63	+0.40	+8.90	17.53	27.07	37.12	49.18	66.41						
400.0	9.56	-1.29	+6.71	15.11	23.99	33.00	42.43	53.43	65.88	82.92						
600.0	-0.74	+7.77	15.99	24.62	33.75	43.00	53.22	63.95	76.66	93.50						
760.0	+4.70	13.35	21.71	30.48	39.76	49.16	59.55	70.44	83.29	99.98						
1000.0	11.36	20.20	28.72	37.66	47.13	56.71	67.28	78.37	91.39	107.89						
2000.0	29.86	39.18	48.17	57.58	67.54	77.60	88.71	100.31	113.78	129.60						
3000.0	42.02	51.66	60.94	70.65	80.93	91.30	102.75	114.67	128.42	143.67						
4000.0	51.34	61.22	70.72	80.66	91.17	101.78	113.48	125.65	139.59	154.35						
5000.0	58.99	69.06	78.74	88.87	99.58	110.38	122.28	134.64	148.74	163.05						
6000.0	65.55	75.79	85.62	95.90	106.78	117.73	129.82	142.34	156.56	170.47						
7000.0	71.33	81.72	91.68	102.09	113.11	124.21	136.45	149.11	163.44	176.96						
8000.0	76.49	87.00	97.09	107.62	118.77	129.99	142.36	155.15	169.57	182.73						
9000.0	81.19	91.82	102.01	112.65	123.92	135.25	147.80	160.64	175.13	187.96						
10000.0	85.54	96.27	106.56	117.30	128.67	140.11	152.70	165.70	180.27	192.78						





The interesting feature of the saturated solution curve is the existence of several vapor pressure maxima in accordance with the thermodynamic theory of saturated solutions first outlined by van der Waals<sup>1</sup> and Roozeboom.<sup>2</sup> Three pressure maxima occur in this system, for solutions saturated with  $2\text{NH}_3\cdot\text{H}_2\text{O}$ ,  $\text{NH}_3\cdot\text{H}_2\text{O}$ , and ice (solid  $\text{H}_2\text{O}$ ) respectively, at temperatures

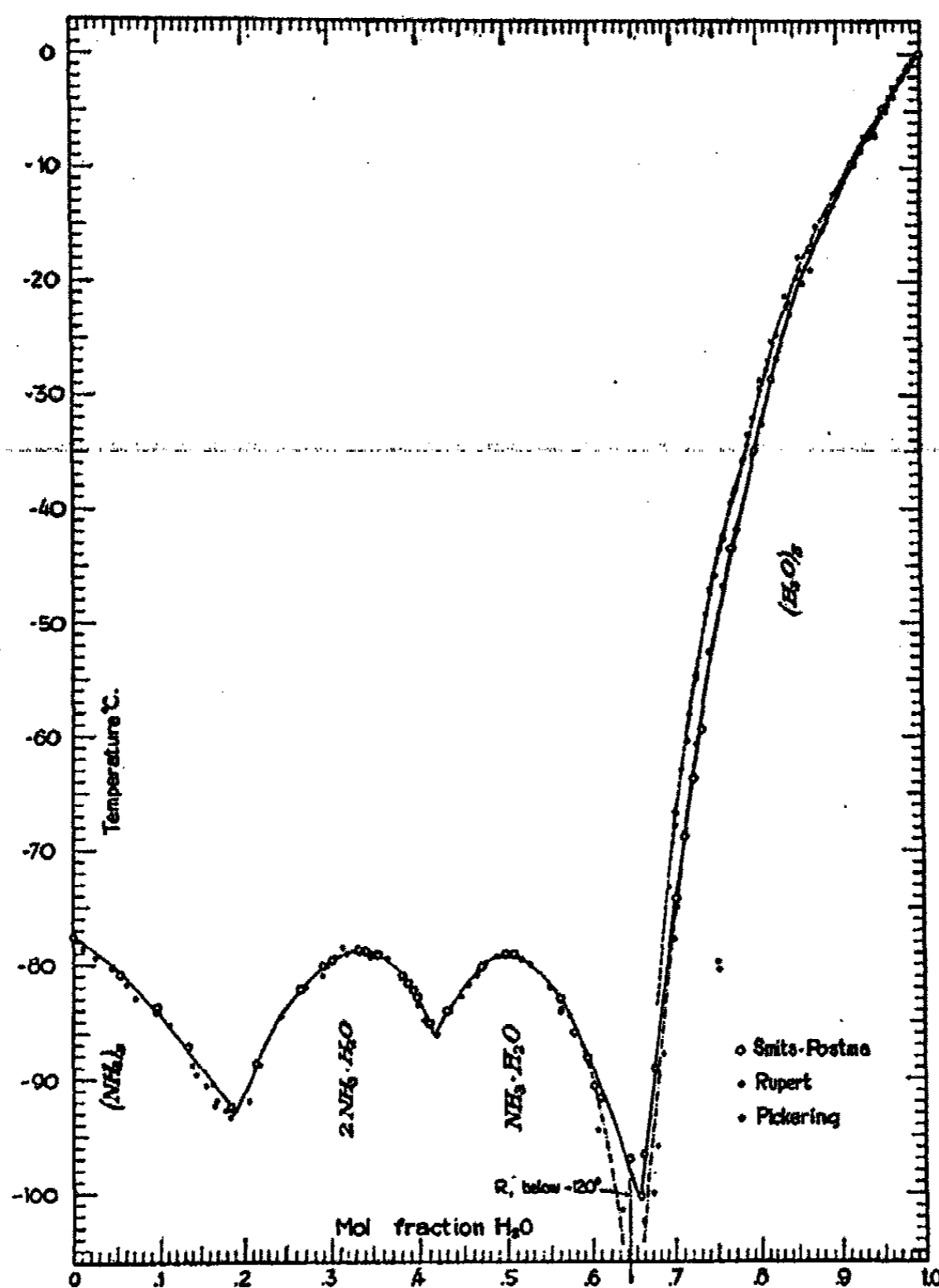

FIG. 7  
Solubility diagram for the system  $\text{NH}_3\text{-H}_2\text{O}$

some distance below the melting point of each pure solid phase. Each of the saturated solutions exhibiting the maximum vapor pressure is richer in  $\text{NH}_3$ , the more volatile component, than the corresponding solid phase with which it is in equilibrium, entirely in accord with the theory.

<sup>1</sup> Van der Waals: "Lehrbuch der Thermodynamik," 2 (1912).

<sup>2</sup> Roozeboom: "Die heterogenen Gleichgewichte," 2 (1904).



## Thermochemical Applications

The evaluation of the heat of vaporization from vapor pressure is at once a test for the accuracy of the data, as well as one of the important reasons for their experimental determination. The calculation is performed thru some modification of the Clapeyron-Clausius equation for the well-known thermodynamic relation between the temperature coefficient of vapor pressure and the volume coefficient of the entropy of vaporization.

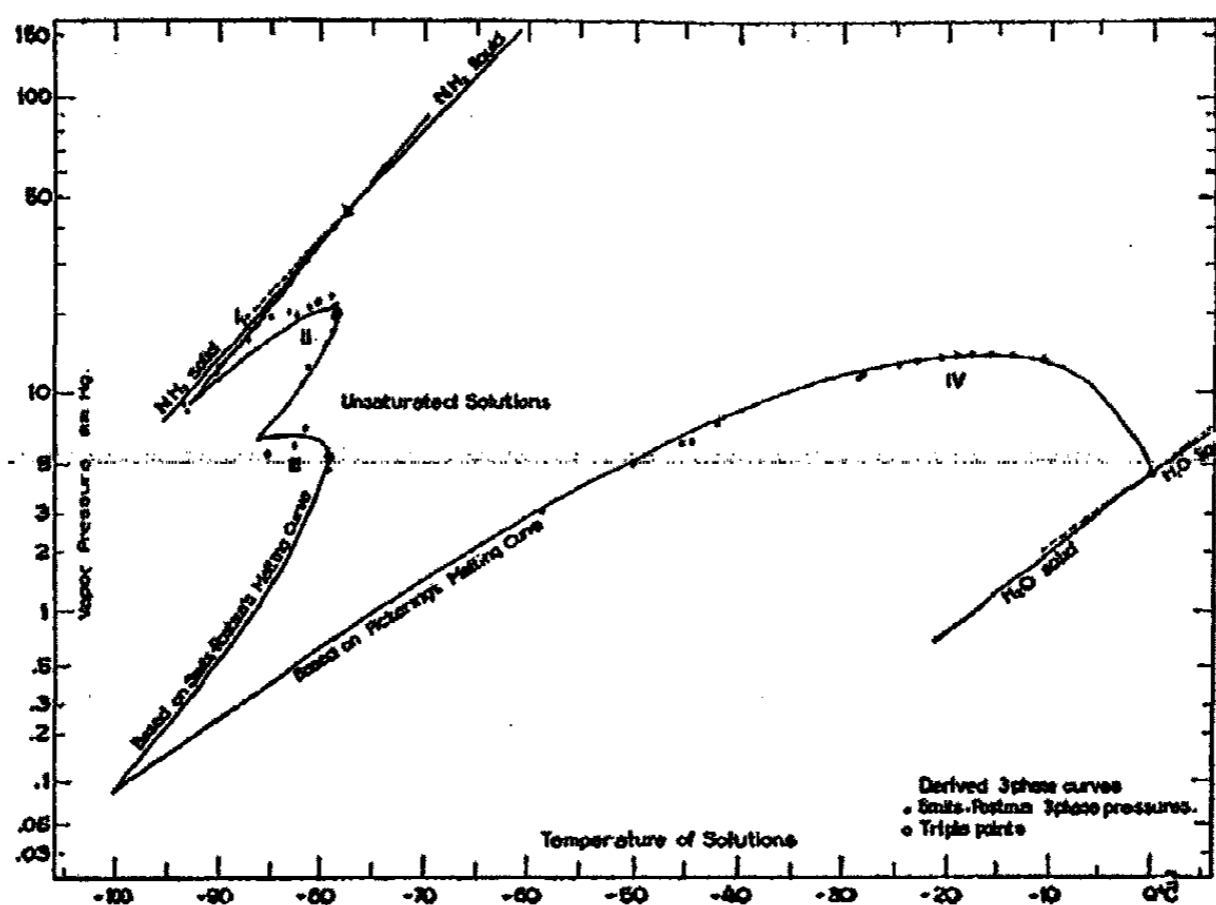

FIG. 8  
Vapor pressure curves for saturated solutions of  $\text{NH}_3\text{-H}_2\text{O}$

If it can be assumed that the heat of vaporization varies linearly over a small range of temperature, the Clapeyron-Clausius equation

$$dp/dT = H/(T\Delta V)$$

can be expressed by the very nearly exact integrated expression

$$\log p_2 - \log p_1 = \frac{H}{2.3026 R_g} \frac{T_2 - T_1}{T_2 T_1} \frac{V_1}{\Delta V} \quad (8)$$

where  $H$  and  $R_g$  are the heat of vaporization and the gas constant, both in cal/mol or in cal/g,  $p_2$  and  $p_1$  are the vapor pressures at the temperatures  $T_2$  and  $T_1$ , and  $V_1/\Delta V$  is the ratio of the ideal volume of vapor to the actual change of volume involved in the conversion of a unit mass of liquid into vapor at the mean temperature between  $T_1$  and  $T_2$ .

Equation (8) yields the heat of vaporization at the mean temperature  $(T_2 + T_1)/2$ ; it is exact in so far as the assumption of the linear variation of  $H$  with  $T$  is valid. If the temperature interval  $T_2 - T_1$  is taken small, the

validity of this assumption is within the experimental error of the measurement of the heat of vaporization.

An exactly similar expression for the heat involved in the formation of one mol of vapor from solution can be derived from Gibbs; since the vapor

TABLE V  
Saturated Solutions

mol % H <sub>2</sub> O	m.pt. °C	p mm Hg cal cd.	Solid Phase	
0.0	-77.60	45.8	NH <sub>3</sub>	(triple point)
5.0	-80.5	34.4	"	
10.0	-84.4	23.3	"	
15.0	-89.0	14.3	"	
18.80	-93.0	9.03	NH <sub>3</sub> + (NH <sub>3</sub> ) <sub>2</sub> H <sub>2</sub> O	(eutectic)
20.0	-91.2	10.5	"	
25.0	-83.85	17.7	"	
30.0	-79.7	20.9	"	
33.33	-78.8	20.2	"	(triple point)
35.0	-79.0	17.4	"	
40.0	-83.85	8.6	"	
41.45	-86.35	6.5	(NH <sub>3</sub> ) <sub>2</sub> H <sub>2</sub> O + (NH <sub>3</sub> ) <sub>2</sub> H <sub>2</sub> O	(eutectic)
45.0	-82.0	6.6	"	
50.0	-79.2	5.4	"	(triple point)
55.0	-81.85	2.7	"	
60.0	-89.0	0.67	"	
65.0	-99.9	0.09	"	
65.40	-100.3	0.083	(NH <sub>3</sub> ) <sub>2</sub> H <sub>2</sub> O + H <sub>2</sub> O	(eutectic)
70.0	-68.7	1.6	"	
75.0	-46.0	6.4	"	
80.0	-31.25	11.4	"	
85.0	-20.1	14.1	"	
90.0	-11.95	13.5	"	
95.0	-5.35	10.3	"	
100.0	0.00	4.579	"	(triple point)
Pressure Maxima				
31.0 ±	-79.0	21.1	(NH <sub>3</sub> ) <sub>2</sub> H <sub>2</sub> O	
43.5 ±	-83.0	6.7	(NH <sub>3</sub> ) <sub>2</sub> H <sub>2</sub> O	
87.0 ±	-17.0	14.3	H <sub>2</sub> O	

composition in general is not the same as the composition of the liquid from which it is formed, it is essential to remember that such an expression applies to the formation of one mol of vapor from an infinite quantity of solution of constant composition.

If the relation between the vapor pressure and temperature is expressed by means of the Ramsay-Young rule, and the heat of vaporization of the reference substance B is known at various temperatures, we have

$$\frac{d \ln p_s}{dT_s} = \frac{H_s}{T_s \Delta V_s} \cdot \frac{V_{1s}}{R_s T_s}$$

and

$$\frac{d \ln p_B}{dT_B} = \frac{H_B}{T_B \Delta V_B} \cdot \frac{V_{1B}}{R_s T_B}$$

Equating  $dp_s$  and  $dp_B$  at  $p_s = p_B$  it follows that

$$\frac{H_s}{R_s} \frac{dT_s}{T_s^2} \left( \frac{V_1}{\Delta V} \right)_s = \frac{H_B}{R_s} \frac{dT_B}{T_B^2} \left( \frac{V_1}{\Delta V} \right)_B$$

or

$$H_s = H_B \frac{T_s^2}{T_B^2} \left( \frac{V_1}{\Delta V} \right)_B \left( \frac{\Delta V}{V_1} \right)_s \frac{dT_B}{dT_s} \quad (9)$$

Further, since according to the Ramsay-Young expression for  $R'$ ,

$$\begin{aligned} T_s &= R' T_B \\ \frac{dT_s}{dT_B} &= R' + T_B \frac{dR'}{dT_B} \\ &= R' + cT_B \end{aligned}$$

so that on substitution,

$$H_s = H_B R' \frac{R'}{R' + cT_B} \left( \frac{V_1}{\Delta V} \right)_B \left( \frac{\Delta V}{V_1} \right)_s \quad (10)$$

It should be noted that the heat of vaporization  $H_s$  of the solution and the volume ratio of the vapor for the solution are taken at  $T_s$ , while the corresponding quantities for the reference substance B are taken at the temperature  $T_B$  at which B exerts the same vapor pressure as the solution at  $T_s$ . The only source of appreciable error in this equation lies in the estimation of the volume ratio for the vapor from solution, since no experimental data on this point are available. In the case of the system  $\text{NH}_3\text{-H}_2\text{O}$  the specific volumes of the liquid and vapor of the components are known accurately; the volume ratio for the solutions can be approximated from these and the composition of the solutions.

The expressions in equations (8) and (10) are accurate enough to be used with confidence. The calculated values of the heats of vaporization of  $\text{H}_2\text{O}$  and  $\text{NH}_3$  at  $25^\circ\text{C}$  are 10494 and 4750.6 cal/mol as compared with the experimental values 10490 and 4749.6, using equation (8) applied to the vapor pressure data of these substances over the temperature interval  $20^\circ$  to  $30^\circ\text{C}$ . Equation (10) yields 10490 cal/mol for the heat of vaporization of  $\text{H}_2\text{O}$  at  $25^\circ\text{C}$  in satisfactory agreement, taking the value of  $H_B$  for  $\text{NH}_3$  from Osborne and Van Dusen's work.<sup>1</sup>

<sup>1</sup>Osborne and Van Dusen: Bull. Bur. Standards, 14, 439 (1918); J. Am. Chem. Soc., 40, 14 (1918).

The heats of vaporization, or, better stated, the heats of formation of a mol of vapor from an infinite quantity of solution have not yet been measured. In Table VI we give values at 25°C calculated from the derived expressions for the Ramsay-Young rule by equation (10), and from the derived values of the vapor pressures in Table IV by equation (8). It will be observed that

TABLE VI  
Heats of vaporization of solutions of NH<sub>3</sub> and H<sub>2</sub>O at 25°C

N <sub>A</sub>	X <sub>A</sub>	H <sub>v</sub> equation (8)	H <sub>v</sub> equation (10)	X <sub>A</sub> H <sub>A</sub> +X <sub>B</sub> H <sub>B</sub>	ΔH <sub>f</sub> *	H <sub>theor.</sub>
0.	0	4750.6	4750.6	4750.6	—	4750.6
0.10	0.00035	4797	4798	4752	43	4795
.20	.0008	4888	4892	4755	172	4927
.30	.0014	5060	5065	4759	376	5135
.40	.0023	5337	5340	4764	688	5452
.50	.00415	5754	5750	4775	1070	5845
.60	.00895	6299	6300	4802	1545	6347
.70	.0238	6935	6949	4887	2055	6942
.80	.0670	7682	7692	5135	2570	7705
.90	.1854	8579	8585	5815	2750	8565
1.00	1.0000	10494	10490	10494	—	10494

\*  $-\Delta H_f$  = heat evolved when 1 mol of condensed vapor is dissolved in an infinite quantity of solution of equilibrium composition.

both methods yield substantially the same values, as they should. In these calculations we have made no assumption regarding the state of the vapor arising from the solutions other than that the volume ratio ( $V_1/\Delta V_v$ ) is directly proportional to concentration. Any further assumption does not enter, since obviously, if the vapor is associated to a certain extent, both  $V_1$  and  $\Delta V$  will be affected to the same extent.  $V_1$  is the ideal volume of unit mass of the vapor at pressure  $p$  and represents the sum of the ideal partial volumes of whatever compounds may occur in the vapor.

Theoretically, the heat of formation of one mol of vapor from a solution of a given composition is equivalent to the sum of the heat required to evaporate  $X_A$  mols of A plus  $1 - X_A$  mols of B, minus the heat evolved when one mol of solution of the composition of the vapor is dissolved in an infinite quantity of solution of the given composition, represented by  $N_A$  of A and  $1 - N_A$  of B.<sup>1</sup> The vapor compositions can be calculated from partial pressure data; the heat of solution referred to above can not be obtained directly, but a rough estimate can be derived for this system from the measurements of the heats of formation of aqueous ammonia solutions by Baud and Gay,<sup>2</sup> and Vrewsky and Sawaritzky.<sup>3</sup> The theoretical values of the heat of vapori-

<sup>1</sup>  $N$  and  $X$  are used in turn to represent the mol fraction of a given component in the liquid and vapor.

<sup>2</sup> Baud and Gay: Ann. Chim. Phys., 17, 398 (1909).

<sup>3</sup> Vrewsky and Sawaritzky: Z. physik. Chem., 112, 90 (1924).

zation of the various solutions are included in the last column of Table VI for comparison. In view of the largely hypothetical basis of the theoretical values the agreement between these and the values given in columns 3 and 4 of this table must be assumed to be somewhat fortuitous.

#### Conclusion

The detailed application of the Ramsay-Young rule to the system  $\text{NH}_3\text{-H}_2\text{O}$  given in the preceding pages is advanced in the hope of showing the comparative ease with which vapor pressure data can be correlated by means of this useful but almost forgotten device. The choice of the system has been fortunate in that experimental values for the entire system are available; when data are available for a portion of a system only, the correlation of the various interlocking relationships (such as the change in the slopes of the Ramsay-Young lines with composition, etc.) is less certain than in the case under consideration, but the same objection applies to any other comprehensive method. Particularly important is the fact that the method is theoretically sound from the standpoint of thermodynamics, as evidenced by the development of equation (10) for the heat of vaporization of solutions and the numerical check of this equation thru the calculation of the heat of vaporization of water from the value for ammonia. Of equal importance is the ability of the method to reproduce the vapor pressure curve for saturated solutions from data on unsaturated solutions and the melting point curve. Too often we find vapor pressures for saturated and unsaturated solutions treated as two distinct phenomena with no apparent connection between them.

Concerning the actual data on the system  $\text{NH}_3\text{-H}_2\text{O}$ , it is interesting to note that no conclusions can be drawn from them regarding the actual state of the solutions, that is, the method gives no information on the question whether compounds between the components occur in the solutions or not. This is evidenced by the apparent inconsistency between the occurrence of the maximum in the slope curve (p. 505) at approximately 36 mol per cent of water, and at 52.5 mol per cent in the heat of formation curve as given by Baud and Gay.<sup>1</sup>

#### Summary

A systematic method for the treatment of vapor pressure data on solutions by means of the Ramsay-Young rule has been developed and applied in detail to the complete system of aqueous ammonia solutions, over the whole range of compositions, and for vapor pressures up to 10,000 mm Hg.

The vapor pressure curve for saturated solutions has been calculated.

Thermodynamic expressions for the heat of vaporization in terms of the Ramsay-Young rule have been worked out for solutions and applied to the calculation of the heats of vaporization of solutions of water and ammonia at 25°C.

*Geophysical Laboratory,  
Carnegie Institution of Washington.*

<sup>1</sup> Baud and Gay: *op. cit.* Recalculation of their data, taking into account the more recent work of Vrewsky and Sawaritzky (*op. cit.*) makes it probable that the maximum in the heat of formation curve lies still further shifted toward the  $\text{NH}_3$  side of the system.

1726  
24A-59

## AN X-RAY INVESTIGATION OF THE STRUCTURE OF COPPER-ZINC OXIDE CATALYSTS\*

BY R. H. ABORN\*\* AND R. L. DAVIDSON\*\*\*

### Introduction

The recent rapid advance in the use of catalysts in chemical industry and its application to increasingly diverse processes has led to two fields of investigation: first, a more complete fundamental understanding of catalytic processes, and second, a knowledge of the structure and changes in the catalyst itself. This paper is concerned primarily with the latter field and secondarily with correlating these observations with the characteristics of the catalytic process itself.

### Preparation of Catalysts

The catalysts examined were specially prepared and tested by other members of the Laboratory staff. The chosen criterion was their effect on the decomposition of methanol.<sup>1</sup> The catalysts were prepared by a standard method of precipitation of  $\text{Cu}(\text{OH})_2$  and  $\text{Zn}(\text{OH})_2$  from varying proportions of their nitrates by means of  $\text{NH}_4\text{OH}$ .<sup>1</sup> The hydroxides were dried and heated in  $\text{N}_2$  at  $220^\circ\text{C}$  to convert them into the oxides. Partial reduction was obtained with methanol vapor at temperatures around  $200^\circ\text{C}$ . The activity test was a continuation of the reduction run and consisted of passing the methanol vapor over the catalyst slowly, at a pressure of one atmosphere and  $360^\circ\text{C}$ . Following this, the catalyst was subjected to X-ray analysis.

### Method of X-ray Analysis

The source of X-rays was a water-cooled molybdenum-target Coolidge tube mounted in a special housing designed in this laboratory,<sup>2</sup> and operating at 30,000 volts R.M.S. and 15 milliamperes. The beam was thoroughly filtered by zirconium oxide filters to make it essentially monochromatic. In all cases except with a pure copper catalyst the resolution of the  $K\alpha$  doublet was insufficient to calculate separately the diffraction line spacings due to the two components so an average value of  $0.710\text{\AA}$ . was used.

The cassette, or film holder, was a semicircular modified Hull type with the film held around the circumference of the 13 cm. radius semi-circle by a supporting strap. The specimens were loaded into thin-wall capillary glass

\* Contribution No. 249 from Dept. of Chemical Engineering, Massachusetts Institute of Technology, Cambridge, Mass.

\*\* Research Associate, Research Laboratory of Applied Chemistry, M. I. T. (Now Instructor in Metallurgy, Harvard University).

\*\*\* Research Assistant, Research Laboratory of Applied Chemistry, M. I. T. (Now with Research Dept., American Rolling Mill Co., Middletown, Ohio).

<sup>1</sup> For further details, see Frolich, Fenske and Quiggle: *Ind. Eng. Chem.*, 20, 694 (1928).

<sup>2</sup> *J. Opt. Soc. America R. & S. I.*, 12, 379 (1926).

tubes 5 cm. long and 0.25 mm. inside diameter and mounted at the center of the above semi-circle. The glass used is known as Corning G 702P and contains a maximum of elements of low atomic number. The required exposure time was approximately 45 hours using a  $\text{CaWO}_4$  intensifying screen behind each film.

TABLE I

Original Mixture Ratio in Catalyst  $\text{CuO}:\text{ZnO} = 48.52$

L = Distance on the film between corresponding lines on opposite sides of the zero beam.

$\theta$  = Angle between incident beam and given set of atomic planes.

Corrected  $\sin \theta$  = True  $\sin \theta$  value based on the rock salt calibration.

Planes are expressed as the Miller indices of the plane family producing the line.

L (cm.)	(degrees)	$\sin \theta$	Corrected $\sin \theta$	Source	Planes	Intensity
6.516	7.18	.1249	.1259	ZnO	(10 $\bar{1}$ 0)	M
7.060	7.78	.1354	.1364	"	(0002)	M
7.407	8.16	.1419	.1429	"	(10 $\bar{1}$ 1)	S
8.744	9.64	.1674	.1685	Cu	(111)	S
9.604	10.56	.1832	.1844	ZnO	(10 $\bar{1}$ 2)	W
10.119	11.14	.1931	.1943	Cu	(200)	M
11.342	12.50	.2164	.2177	ZnO	(11 $\bar{2}$ 0)	M
12.475	13.75	.2377	.2392	"	(10 $\bar{1}$ 3)	M
13.418	14.78	.2552	.2568	"	(11 $\bar{2}$ 2)	M
13.636	15.03	.2592	.2608	"	(20 $\bar{2}$ 1)	W
14.365	15.83	.2728	.2745	Cu	(220)	M
16.985	18.72	.3209	.3230	"	(311)	M
17.857	19.68	.3368	.3390	"	(222)	W

Intensities were estimated on the following basis:

S = Strong

M = Medium

W = Weak

#### Precision of Measurements

The films were measured on a comparator consisting of a vernier caliper mounted in a frame suitable for holding the film. The vernier caliper can be read to .002 cm. which was usually found to be within the accuracy of determining the line position by eye. The center of each line was measured 4 to 8 times approaching the line from opposite sides alternately. The precision of measurement has been calculated to be better than  $\pm 0.01$  cm. which gives the lattice spacing measurements a precision of 0.2% at small diffraction angles and .05% at large angles.

Whenever possible, several lines were used in the calculation of a given spacing, and an average taken. The unit cell dimensions of copper are believed to be correct to  $\pm 0.002$  Å. The accuracy of calculation of the unit

cell sizes of the catalysts is believed to be greater than the reproducibility of the treatment of the catalyst.

The cassette used throughout the series was calibrated with rock salt whose cube edge spacing of 2.813 Å. is very accurately known.

To avoid errors arising from film shrinkage, every film was developed and dried by a standard method and measured approximately two days after developing.

As a check on the general reproducibility of the work, catalysts of the same composition (CuO: ZnO = 48:52) but from two different methanol decomposition runs were compared as to copper lattice spacing. The resulting two points on Fig. 1 at that composition show how well the spacings agreed, the catalytic treatment accuracy equalling that of the X-ray work alone (i.e.  $\pm .002\text{Å}$ ).

#### Experimental Data

Measurements of a typical film are given in Table I.

The length of the edge ( $a_0$ ) of the cubic unit cell of copper in each composition studied was computed by taking the average of the corresponding values calculated from each line. These values are tabulated for the different compositions in Table II.

TABLE II

Dimensions expressed in Ångström Units ( $1\text{Å} = 10^{-8}\text{ cm.}$ )

Composition Original Catalyst in Mol% CuO:ZnO	$a_0$ (Cu)	$c$ (ZnO)	$a$ (ZnO)	$c/a$ (ZnO)
100 : 0	3.609	—	—	—
97 : 3	3.615	—	—	—
87 : 13	3.616	— *	—	—
77 : 23	3.619	5.240	3.263	1.6059
48 : 52	3.653**	5.234	3.261	1.6050
41 : 59	3.654	5.222	3.253	1.6054
33 : 67	3.638	5.217	3.251	1.6047
21 : 79	3.641	5.203	3.239	1.6063
10 : 90	3.657	5.201	3.242	1.6064
0 : 100	—	5.212	3.245	1.6061

\* Only one ZnO line was observed.

\*\* A check run with fresh catalyst of this composition gave  $a_0 = 3.651\text{Å}$ .

The size of the hexagonal zinc oxide lattice may be determined from two dimensions, the height ( $c$ ) of the hexagonal unit cell, and the horizontal spacing ( $a$ ) equal to half the distance between opposite corners of the base. Knowing the angle which a given set of atomic planes makes with  $c$  and  $a$ , these two values may be calculated from each diffraction line. When the angle is zero or  $90^\circ$  only one of the two has a significant value. The one assumption made in these calculations is that the above angle does not vary



with changing catalyst composition. That this is justified may be seen from Table II which shows that the axial ratio  $c/a$  is fairly constant (maximum observed variation within 0.11%). For each composition the values of  $c$  as well as those of  $a$  were averaged from all the lines. The average values are given in Table II.

"Extra" lines observed are shown in Table III.

TABLE III

Observed sine values Catalyst Composition CuO:ZnO		Sine values for Gamma Brass
77:23	21:79	
.1511		.1503
.1742		.1701
.2477		.2475
.2523	.2524	.2539
	.3011	.3008

### Discussion of Results

One of the most evident observations resulting from this investigation is the essential crystallinity of the catalyst structure at every composition. As to the phases present, the pure copper oxide catalyst has the same structure as that of ordinary metallic copper, indicating practically complete reduction. The pure zinc oxide catalyst structure is equivalent to the usual zinc oxide structure, while intermediate compositions show essentially only these two lattices though exhibiting varying dimensions.

The length of the edge of the cubic cell of copper in the catalyst of 100% copper oxide initial composition is  $3.609\text{\AA}$ . This value is only slightly higher than that given in the International Critical Tables ( $3.603\text{\AA}$ ) and lies well within the range ( $3.61 \pm .01\text{\AA}$ ) which is given in the Ewald-Hermann Strukturbericht (now being presented in the *Zeitschrift für Kristallographie*). Ewald, in discussing the range in the latter figure, states that it is probable that the smaller value corresponds to the purer material. Despite purification precautions, this reduced catalyst may contain traces of impurities, such as oxide or possibly hydrogen.

The plot in Fig. 1 of the unit cell dimensions of the copper lattice against total % of zinc in the catalyst shows an expansion (plotted downward for a reason to be explained later) as the zinc content is increased, passing through a maximum and then a secondary minimum. The maximum observed expansion is 1.3% at 90% zinc oxide.

Why should the copper lattice expand? While there may be several possible explanations, there are only two which need serious consideration. The first is solution of hydrogen in the copper lattice, which has been shown to occur in copper sputtered at a high temperature in the presence of hydrogen.<sup>1</sup> In the present case, however, the temperature was always much lower

<sup>1</sup> Bredig and Allolio: *Z. physik. Chem.*, 127, 41 (1927).

and the partial pressure of hydrogen in the gas during the reduction of the catalyst was never above a fraction of an atmosphere. Furthermore, there seems to be no logical reason for an increase in hydrogen solution due to increasing zinc oxide content.

The second possibility is an expansion due to the formation of a solid solution of reduced zinc in the copper lattice.<sup>1</sup> (a solid solution of zinc oxide in copper seems very unlikely). The observed loss in weight during reduction of each catalyst was always greater than could be accounted for on the basis of known changes such as reduction of some copper oxide to copper. Since no

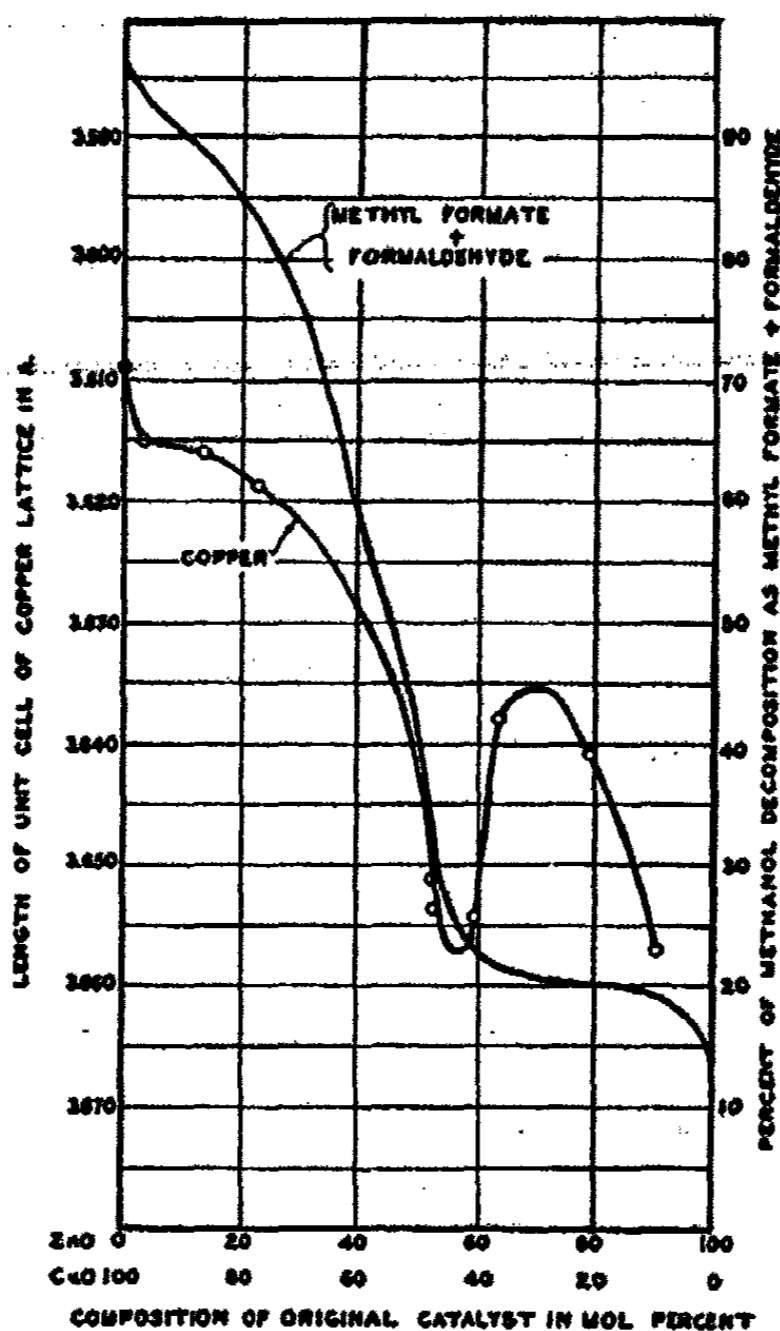

FIG. 1

diffraction lines due to zinc were found at any composition it is unlikely that any appreciable amount of free reduced zinc remained as such in the catalyst. A copper lattice expanded by the partial substitution of zinc for copper atoms is nothing more than alpha brass, a well-known stable alloy. In this alloy the expansion of the brass is a linear function of the amount of zinc present (up to nearly 40%). It is interesting to note as further evidence in favor of this solid solution that at every catalyst composition the amount of zinc

<sup>1</sup> Westgren and Phragmen: *Phil. Mag.*, 1, 311 (1925).

which would be necessary (based on the alpha brass expansion curve) to cause the observed expansion is no larger than the amount calculated to be present from the loss in weight data.

Thus, this solid solution of zinc in the copper lattice seems so reasonable, that further discussion will be based on this assumption.

The dimensions of the 100% zinc oxide catalyst ( $c = 5.212 \text{ \AA}$ .) and  $a = 3.245 \text{ \AA}$ .) lie between the International Critical Tables values ( $5.23 \text{ \AA}$ .) and

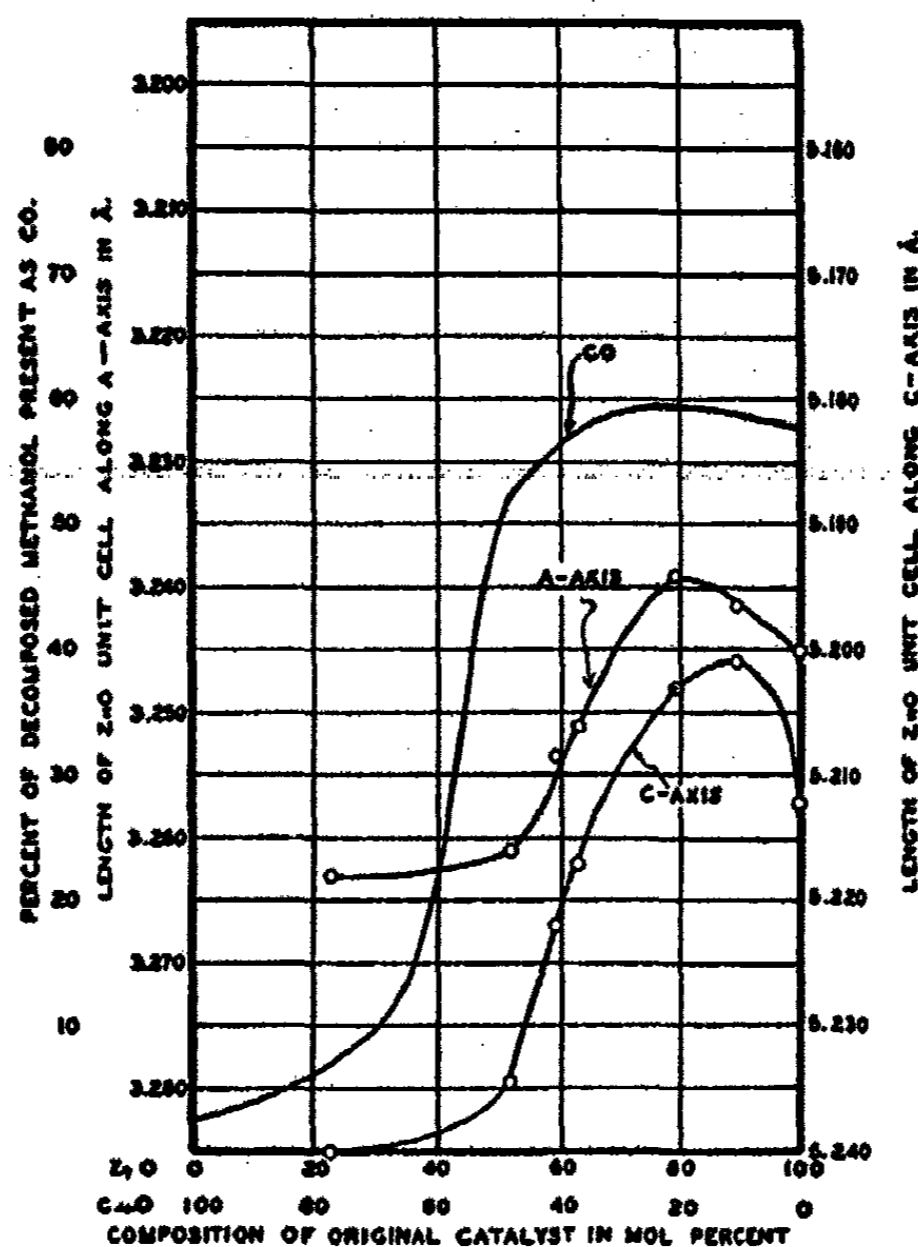

FIG. 2

$3.25 \text{ \AA}$ .), and the Strukturbericht values ( $5.18 \text{ \AA}$ .) and  $3.24 \text{ \AA}$ .). Analogous to the 100% copper oxide catalyst it seems that this may contain traces of impurities.

Plotting  $c$  and  $a$  separately against the total per cent of zinc in the catalyst (Fig. 2), with expansion again plotted downward, a contraction first occurs as copper oxide is added. This reaches a maximum, then decreases and subsequently is followed by an expansion for copper oxide contents greater than 35%.

From Table I it may be seen that the zinc oxide axial ratio  $c/a$  passes through a minimum at a composition approximately corresponding to the principal maximum expansion on the copper curve as well as the maximum contraction on the zinc oxide curves. The maximum change in the axial

ratio (0.11%) is small in comparison with the change in the axial lengths,  $c$  and  $a$ . As the curves indicate, it is due to the parallel tendencies in the latter changes.

The lattice dimension curves in Fig. 2 all stop at 23% zinc oxide content due to the fact that at the next composition (13%) only one ZnO line was observed and none at any concentrations below 13%. This in itself is further evidence of the formation of reduced zinc.

As to the cause of these observed changes in the zinc oxide cell dimensions two possible explanations seem worthy of consideration. These are a partial reduction presumably to a sub-oxide and the substitution of copper atoms in the zinc oxide lattice forming a solid solution. The existence of a true sub-oxide of zinc has never been proven. However, if partial reduction leads to a contraction, while the "dissolving" of copper atoms causes an expansion (as is often the case in a substituted type of solid solution), then it may be that the former action is effective at low copper concentrations, where the copper acts essentially as a promoter,<sup>1</sup> while the latter action is effective at higher copper concentrations.

The "extra" lines listed in Table III were those which could be identified neither with zinc oxide nor copper. Catalysts of several compositions gave faint indications of one or more of the tabulated lines, but in only two were they strong enough to measure.

The lines of the most probable substances,<sup>2</sup> Zn, CuO, and Cu<sub>2</sub>O, as calculated or observed on control films, in no case checked the extra lines. Since the formation of alpha brass has been assumed, the possibility of the formation of beta brass was next investigated. Again the result was the same. When, however, the same tests were applied to gamma brass a fair agreement was found as is indicated in the last column of Table III.

The strongest line of gamma brass has practically the same position as the strongest copper line so one could not expect to identify it in catalysts of this type. Since the agreement is only fair and since some of the "extra" lines correspond to gamma brass lines described by Westgren and Phragmen<sup>3</sup> as weak, these results are far from establishing the presence of gamma brass.

Gamma brass corresponds to a definite compound<sup>4</sup> Cu<sub>5</sub>Zn<sub>8</sub> capable, however, of forming solid solutions with either copper or zinc through a limited range.

Since the compositions at which the extra lines were most in evidence corresponded approximately to a mol ratio of copper to total zinc of 4:1 and 1:4, the "over-structure" lines predicted by Tammann<sup>5</sup> at simple atomic ratios and observed by several investigators<sup>6</sup> in alloy systems such as gold-

<sup>1</sup> Frohlich: Fenske and Quiggle: *Ind. Eng. Chem.*, 20, 694 (1928).

<sup>2</sup> Freeman, Sillers and Brandt: *Sci. Papers Bur. of Standards*, 20, 661 (1926); Niggli: *Z. Krist.*, 57, 253 (1922).

<sup>3</sup> Westgren and Phragmen: *Phil. Mag.*, 1, 311 (1925).

<sup>4</sup> Bradley and Thewlis: *Proc. Roy. Soc.*, 112A, 678 (1926).

<sup>5</sup> Tammann: "Lehrbuch der Metallographie", 3rd Ed., 450.

<sup>6</sup> Bain: *Chem. Met. Eng.*, 28, 21 (1923); Johannsson and Linde: *Ann. Physik*, (4) 82, 449 (1927).

copper and palladium-copper under special equilibrium conditions may possibly be given by these catalysts. The authors, however, did not succeed in correlating the observed "extra" lines with any definite type of "overstructure" and incline to the gamma brass explanation.

#### Relationship of the X-Ray Data to the Curves of Methanol Decomposition as a Function of Catalyst Composition

As this phase of the problem has been treated in detail in another paper<sup>1</sup> only a brief discussion will be allotted to it here. The analysis of the products resulting from the decomposition of methanol as a function of catalyst composition is given in Fig. 3.

Since methyl formate and formaldehyde are the primary products when the catalyst is 100% copper oxide while carbon monoxide is principally produced when the catalyst is 100% zinc oxide, it is logical to examine the relationship between the methyl formate-formaldehyde production and copper lattice dimension curves and likewise between the carbon monoxide and zinc lattice dimension curves. These comparisons are made in Figs. 1 and 2. The ordinates of the lattice dimensions are lengths plotted with increasing values downward in order to facilitate comparison with the activity curves. The similarities in shape are striking and though the agreement is only approximate it is enough to indicate an important relation between atomic spacings in a catalyst and its specific property of favoring a given reaction. It seems likely that the relation between atomic spacings in the surface regions of a catalyst and the size of the molecules of reaction products is one of the primary factors in determining the specific character of the catalyst. The evidence is still insufficient, however, to differentiate between a purely geometrical effect and one which is the result of a change in the distribution of residual forces or "valences" with changing inter-atomic distances.

The amount of methanol decomposed was found to be practically independent of the catalyst composition except for a slight "promotion" effect at the extreme ranges of composition. Thus, while changes in lattice dimensions of the catalyst components do not seem to be a factor in the per cent of methanol decomposed it may be that particle size, i.e. surface area of the catalyst is a factor. In this connection some preliminary work on the particle

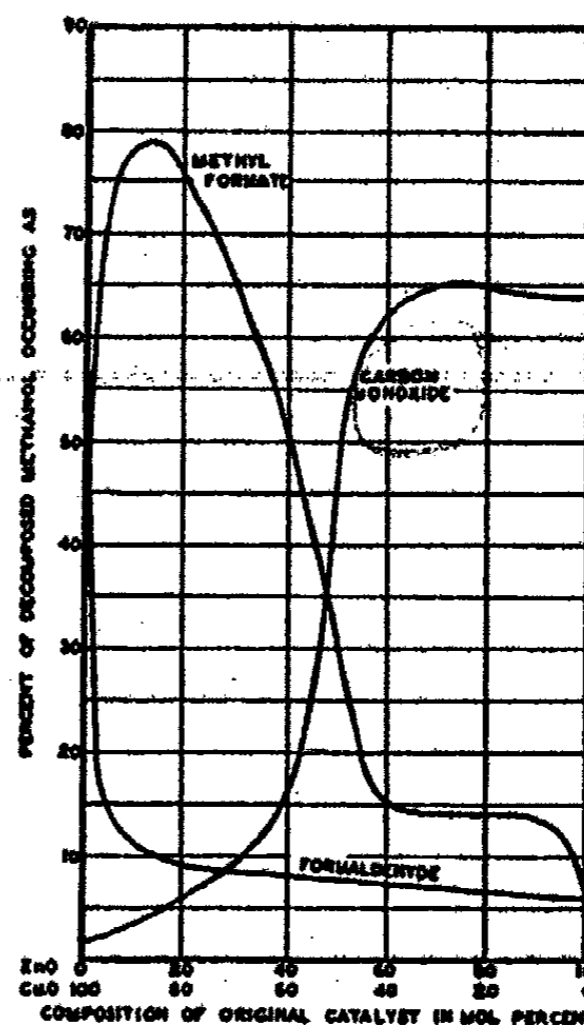

Fig. 3

<sup>1</sup> Frolich, Davidson, and Fenske: Ind. Eng. Chem., 21, (1929).

size of these catalysts has been carried out using the Debye-Scherrer method<sup>1</sup> but thus far only a few quantitative results have been obtained. The 100% copper catalyst diffraction pattern shows relatively sharp lines, while the 100% zinc oxide catalyst pattern shows somewhat broader and more diffuse lines, and intermediate compositions give considerably broader and more diffuse lines with evidence of much more scattered radiation. Per se, this would indicate that the copper catalyst has the largest particle size, with intermediate compositions possessing a much smaller particle size, and the zinc oxide catalyst intermediate in size. There are, however, many other factors entering into an accurate determination of particle size by this method so much further work would be necessary to substantiate these qualitative observations.

#### Summary

1. Over the entire composition range the structure of the catalysts is essentially crystalline and of the same lattice type as characterizes the final principal components (copper and zinc oxide) in their normal states.
2. The length of the edge of the cubic cell of the copper lattice expands with increasing percent of zinc oxide in the catalyst. This is believed to be due to the formation of alpha brass.
3. Both the vertical and horizontal dimensions of the unit hexagonal cell of the zinc oxide lattice vary in the same direction with changing composition. This variation changes from a contraction at high zinc oxide concentrations to an expansion at high copper concentration. Two possibilities are advanced in explanation—a partial reduction of the oxide and a solid solution of copper in the oxide. In spite of these changes the axial ratio of zinc oxide remains practically constant.
4. No diffraction lines due to zinc were observed. A very few "extra" lines appearing on several films were found to agree more clearly with those of gamma brass than with any other suggested possibility.
5. A comparison of the X-ray results with those obtained by a study of catalytic activity points to an important relation between inter-atomic spacings in a catalyst and its specific property of favoring a given reaction.
6. In the decomposition of methanol the essential feature of these catalysts is not their effect on the total decomposition, but their selective nature with respect to the mechanism by which the decomposition occurs.

#### Acknowledgment

The authors are especially indebted to Professor P. K. Frolich for his helpful cooperation in the study of the catalysts.

<sup>1</sup> Glocker: "Materialprüfung mit Röntgenstrahlen" (1927).

## THE SOLUBILITY OF SOLUBLE ELECTROLYTES\*

### II. The Solubility of the Alkali and Alkaline Earth Bromides in Hydrobromic Acid

BY ARTHUR F. SCOTT AND EDWARD J. DURHAM

The material presented in this paper was obtained in order to supplement the already existing data of Engel, Armstrong and Eyre, Masson, and Ingham for the alkali and alkaline earth chlorides in hydrochloric acid. In a subsequent paper these and other data will be discussed from a theoretical standpoint.

#### Apparatus

**The Thermostat.**—All the measurements were carried out in a specially designed thermostat of seventy-five liters capacity, the essential features of which were as follows. The tank of welded copper was suitably insulated with four inches of shredded asbestos and magnesia packing in the interspace between the tank and its containing box of stout oak. Around the inside of the tank was a coil of three-eighths inch copper tubing through which ice water was passed for cooling purposes. Stirring was accomplished by means of a four-inch, four-bladed propeller driven by a one-sixth horsepower motor connected through a worm and worm gear to give a speed of 800 R.P.M. The shaft for holding the saturation bottles extended horizontally the length of the bath and was driven from the same motor by an external belt connection and bevel gears in the bath at a speed of 60 R.P.M.

Heating was accomplished by means of a 250-watt knife-type heater controlled through a four-fingered regulator of the usual kind and a relay. The regulator was filled with thoroughly dried ethyl acetate which has proven more satisfactory for temperatures up to fifty degrees than the commonly used toluene. The temperature of the bath as determined with a 100° thermometer calibrated by the U. S. Bureau of Standards was  $25.00 \pm .01^\circ$ . Exploration with a Beckmann thermometer showed that the temperature was constant throughout the bath within the above-mentioned limits at all times.

**The Saturation Bottles.**—These were 250 cc glass-stoppered pyrex bottles, the necks and stoppers of which were protected from the liquid in the bath by means of glass caps held in place by rubber rings just above the junction of the neck and bottle proper. The glass stoppers were held in place inside the protecting caps by tightly-fitting rubber stoppers. The bottles themselves were secured in alternate and opposite positions and also at right angles to the shaft by adjustable brass clamps, which also insured the tightness of the protecting caps.

\* Contribution from the Department of Chemistry of The Rice Institute.

### Materials

*Hydrobromic acid* was made by passing thoroughly washed hydrogen sulfide into pure bromine. After separating the sulfur and sulfur bromide by decantation, barium hydroxide was added to precipitate sulfuric acid formed during the reaction; the mixture was heated and the sulfate and additional coagulated sulfur were filtered off. The resulting solution was distilled and the portion coming over between 118° and 126° was collected and redistilled as before. The resulting product, a constant-boiling mixture of hydrobromic acid containing about forty-seven percent hydrogen bromide, was stored in pyrex bottles.

*Bromides.* Samples of lithium, magnesium, strontium, barium, and calcium bromides were prepared by dissolving the chemically pure carbonates, which had been washed five or six times by decantation, in a slight excess of pure hydrobromic acid. The solutions were evaporated to dryness to eliminate the excess acid, then redissolved and filtered through a Munroe crucible before crystallization. The crystals were drained from the mother liquor and washed sparingly on a porcelain Büchner funnel. Sodium bromide was prepared in a like manner from recrystallized sodium carbonate and hydrobromic acid.

Potassium bromide was obtained by recrystallization of a sample of C. P. salt. It was found necessary, however, in this process as in previous purifications to filter the dissolved salt through a Munroe crucible in order to eliminate the foreign matter which seems to be present invariably in the best commercial preparations. It was soon discovered on making the first acid addition to this potassium bromide that free bromine was liberated in some quantity. This sample after treatment with an excess of hydrobromic acid and subsequent evaporation and recrystallization was judged to be satisfactory. Ammonium bromide and a sample of calcium bromide were prepared from the C. P. salts in the same manner as was finally adopted for the potassium bromide.

### Procedure

To determine the solubility of the pure salts, solutions were made up in the saturation bottles with distilled water and enough salt to leave about twenty grams excess. Subsequently the acidities of these solutions were adjusted roughly by the additions of suitable amounts of forty-seven percent hydrobromic acid. The salt was always kept in excess by further additions of solid salt when necessary. In preparing the most acid solutions of calcium bromide and lithium bromide, it was necessary, because of their high solubilities and relatively slight precipitating effect of the acid to dissolve the salt directly in the hydrobromic acid solution.

The solutions were usually adjusted at night, allowed to stand until morning in the thermostat, and then agitated continuously for about nine hours. After stopping the rotation of the bottles the excess salt was allowed to settle for at least half an hour and samples were then transferred to tared weighing bottles by means of warmed pipets attached to short filtering tubes.



somewhat similar to those described by Richards.<sup>1</sup> These filtering tubes were about two inches long with a short bend at the lower end. The inlet opening was on the top side of this bend so that there would be no tendency for salt to be drawn into the opening on the application of suction. In addition to this precaution a filter plug of cotton or asbestos was always placed in the tube.

In order to be certain that the original period of agitation was sufficient to insure complete saturation, samples of a number of the solutions were taken after an additional twelve hours standing followed by seven or eight hours further agitation. The results of these experiments are given in Table I.

The samples in the weighing bottles were allowed to reach the temperature of the balance room and were then weighed, usually within an hour of being taken.

Analyses were made on aliquot portions of the suitably diluted samples. Acidity was determined by titration with twentieth normal potassium hydroxide solution which was standardized against a hydrochloric acid solution whose strength had been obtained gravimetrically. Total bromine was determined by the Volhard method, using tenth normal silver nitrate and twentieth normal ammonium thiocyanate solutions; the former was checked against a sodium chloride solution standardized gravimetrically and the latter was titrated against the silver solution. The strengths of the solutions were never allowed to become doubtful since they were made up and standardized in two liter portions as needed.

Because of the relatively small acid content of some of the samples it was considered advisable, in order to obtain the maximum precision offered by the analytical methods employed, to take one large sample (15-25 gms.) for the acid analysis. To make certain that this sample was representative of the saturated solution it was also analyzed for total bromine and the result compared with the total bromine found in a second separate sample (5-7 gms.). To determine whether the above procedure was justified, solutions of three salts were examined by taking two separate samples and analyzing each for total bromine and acid. In addition the acid content of a third sample was found. The results obtained are given below, and are expressed as grams per 100 grams solution. Further, each value in this and the following table is the mean of duplicate analyses.

Salt	KBr and HBr		BaBr <sub>2</sub> and HBr		CaBr <sub>2</sub> and HBr	
	HBr as Br	Total Br	HBr as Br	Total Br	HBr as Br	Total Br
A	6.89	27.70	5.26	27.16	3.44	46.77
B	6.90	27.71	5.31	27.23	3.45	46.85
C	6.90	—	5.30	—	3.43	—

As a further illustration of the nature of agreement between duplicate samples, the following data showing total bromine content for the sodium bromide series are representative.

<sup>1</sup> Richards and Fraprie: Am. Chem. J., 26, 75 (1901).

NaBr solution	Total bromine- gms. per 100 gms. soln.	
	Sample A	Sample B
1	37.43	37.46
2	37.59	37.59
3	37.76	37.86
4	38.11	38.19
5	38.63	38.65

All the volumetric apparatus employed was carefully calibrated and temperature corrections were applied throughout. The weights were gold plated and had recently been calibrated by a modified Richards method. All sample weights were corrected to vacuum.

### Results

In Table I are given data showing the effect of prolonged agitation on the solubility of several of the salts and mixtures of salt and acid. Here also each value represents the mean of duplicate analyses.

TABLE I  
Effect of Length of Agitation on Attainment of Saturation.

Salt	Time of agitation Hours	All values in gms. per 100 gms. soln.			
		Acid as Br.	Total Br	HBr	Salt
KBr & HBr	9	6.90	27.71	6.99	30.99
	18	6.89	27.70	6.98	30.99
BaBr <sub>2</sub> & HBr	9	5.30	27.23	5.37	40.78
	17	5.26	27.16	5.33	40.72
LiBr	10	—	55.66	—	60.49
	21	—	55.51	—	60.32
SrBr <sub>2</sub>	10	—	32.22	—	49.89
	21	—	32.28	—	49.97
CaBr <sub>2</sub>	8	—	46.80	—	58.53
	16.5	—	46.80	—	58.53
CaBr <sub>2</sub> & HBr	8	3.44	46.85	3.48	54.29
	19	3.44	46.77	3.48	54.19

It is evident from the above data that the nine-hour period of continuous agitation employed in this investigation can be considered sufficient to insure complete saturation.

In Table II are collected the summarized data for the eight alkali and alkaline earth bromides measured. Each value represents the mean of duplicate analyses on at least two separate samples.

Salt	Solubility in gms. per 100 gms. solution.			Salt
	Acid as Br	Total Br	HBr	
KBr	—	27.28	—	40.62
	6.90	27.71	6.98	30.99
	13.06	28.65	13.23	22.69
	17.84	29.66	18.07	17.60
NaBr	—	37.45	—	48.22
	4.55	37.59	4.61	42.55
	8.93	37.81	9.04	37.19
	12.82	38.15	12.98	32.62
	17.43	38.64	17.65	27.31
NH <sub>4</sub> Br	—	35.79	—	43.86
	12.37	35.43	12.53	27.91
	16.73	36.61	16.94	24.06
	22.49	36.40	22.72	15.96
LiBr	—	55.59	—	60.41
	(5.37)	(56.24)	(5.44)	(55.29)
	(23.63)	(58.68)	(23.93)	(38.09)
	(29.53)	(61.23)	(29.90)	(34.45)
BaBr <sub>2</sub>	—	27.04	—	50.28
	5.28	27.20	5.35	40.76
	9.07	27.57	9.19	34.40
	12.65	28.10	12.81	28.73
SrBr <sub>2</sub>	—	32.25	—	49.93
	3.72	32.90	3.77	45.18
	9.27	33.95	9.39	38.21
	17.28	35.60	17.50	28.36
MgBr <sub>2</sub>	—	43.33	—	49.93
	4.64	44.05	4.70	45.40
	9.71	44.72	9.83	40.33
	14.61	45.47	14.79	35.55
CaBr <sub>2</sub>	—	46.80	—	58.53
	3.44	46.81	3.48	54.24
	7.14	47.19	7.23	50.09
	(10.70)	(49.62)	(10.84)	(48.67)

Since considerable care was exercised in making the present determinations the initial solubilities have additional significance. Therefore, in Table III is presented a comparison of the present data with those given in the literature.

TABLE III

Comparison of Solubility Data at 25°. Gms. salt per 100 gms. solution			
Salt	Present values	Other data	Observer
KBr	40.62	40.57	Scott and Frazier <sup>1</sup>
		40.4	Average curve <sup>2,3,4,5</sup>
NaBr	48.22	48.61	Scott and Frazier <sup>1</sup>
		48.3	de Coppet <sup>3</sup>
NH <sub>4</sub> Br	43.86	43.7	Eder <sup>7</sup>
		44.2	Smith and Eastlake <sup>8</sup>
LiBr	60.41	64.8	Kremers <sup>6a</sup>
BaBr <sub>2</sub>	50.28	50.0	Etard <sup>2</sup>
		51.4	Kremers <sup>6b</sup>
		51.10	Milikan <sup>9</sup>
SrBr <sub>2</sub>	49.93	49.79	Milikan <sup>9</sup>
MgBr <sub>2</sub>	49.93	49.4	Menschutkin <sup>10</sup>
CaBr <sub>2</sub>	58.53	60.5	Kremers <sup>6a</sup>
		60.07	Milikan <sup>9</sup>

The only mixtures of salt and acid with which our values can be compared are those of Ditte<sup>11</sup> for sodium bromide. Although his measurements were made at 20°C. and are therefore not directly comparable, they give, when plotted, practically the same curve as the present data. This paper of Ditte was discovered only after the conclusion of the present investigation and, curiously enough, has been overlooked by all the compilers of the standard references on solubility.<sup>12</sup>

<sup>1</sup> Scott and Frazier: *J. Phys. Chem.*, 31, 459 (1927).

<sup>2</sup> Etard: *Ann. Chim. Phys.*, 2, 503 (1894).

<sup>3</sup> de Coppet: *Ann. Chim. Phys.*, 30, 411 (1883).

<sup>4</sup> Tilden and Shenstone: *Proc. Roy. Soc.*, 38, 345 (1883).

<sup>5</sup> Meusser: *Z. anorg. Chem.*, 44, 79 (1905).

<sup>6a</sup> Kremers: *Ann. Physik Chem.*, 103, 57 (1858).

<sup>6b</sup> Kremers: *Ann. Physik Chem.*, 99, 25 (1856).

<sup>7</sup> Eder: *Sitzb. Akad. Wiss. Wien*, 82, 1284 (1880).

<sup>8</sup> Smith and Eastlake: *J. Am. Chem. Soc.*, 38, 1261 (1916).

<sup>9</sup> Milikan: *Diss. Leiden*, (1914).

<sup>10</sup> Menschutkin: *Z. anorg. Chem.*, 52, 152 (1907).

<sup>11</sup> Ditte: *Ann. Chim. Phys.* (7), 10, 556 (1897).

<sup>12</sup> Including, "International Critical Tables," Comey's "Dictionary of Solubility," Seidell's "Solubilities," Landolt-Börnstein, and Eyre's Compilation in the Reports of the British Association.

### Discussion

During the course of the work an interesting phenomenon was noted in connection with several of the saturated solutions. On addition of hydrobromic acid to a calcium bromide solution, a distinct pink color appeared. Moreover, the solution showed a tendency to fume which increased on further additions of acid. No odor of free bromine could be detected and no trace could be obtained on extraction with chloroform or ether. The first sample, after evaporation with excess hydrobromic acid and recrystallization still turned pink on addition of acid as did another sample of calcium bromide prepared from the pure carbonate and hydrobromic acid. Likewise the same phenomenon occurred with the solutions of lithium, strontium, and magnesium bromides, the color in the last two being less marked and unaccompanied by noticeable fuming. Since those measurements on the solutions which showed marked fuming are necessarily somewhat less reliable, they are therefore included in parentheses in Table II.

The appearance of the pink coloration is evidently not due to the presence of free bromine. It may possibly be connected with the ionic strength of the cation because the intensity of color as well as of fuming was most pronounced in those solutions containing the strongest cation. More precisely, the intensity of color follows the same sequence as the solubility of these salts which, incidentally, are all hydrated.

### Summary

The results of this investigation may be summarized as follows:

1. The solubilities at 25°C of the bromides of potassium, sodium, ammonium, lithium, barium, strontium, calcium, and magnesium in pure water and in the presence of hydrobromic acid in amounts up to about 60 mol per cent have been determined for the first time.
2. Saturated solutions of lithium, calcium, strontium, and magnesium bromides develop a decided pink color, which is not due to the liberation of bromine, on addition of hydrobromic acid. Furthermore, the more acid solutions of these salts fume strongly of hydrogen bromide.

*Houston, Texas.*

PARALLELISM IN THE DECOMPOSITION OF AMMONIUM,  
HYDRAZINE, AND HYDROXYLAMMONIUM NITRITES.  
HYPONITROUS ACID AS A HYDROXYLAMINO-  
NITROUS ACID

BY L. F. AUDRIETH

The action of nitrous acid upon organic derivatives of ammonia, hydrazine, and hydroxylamine has been the subject of considerable investigation and has led to the isolation and study of such groups of substances as the diazonium and diazo compounds, nitrosamines, nitroso-hydroxylamines, nitrosohydrazines, azides, and others. Strictly inorganic reactions involve the formation of nitrogen by the interaction of ammonium salts and nitrites, the preparation of nitrous oxide and the formation of hyponitrites from hydroxylamine salts and nitrites, and the synthesis of hydrazoic acid and azides by the action of nitrites upon hydrazine and hydrazine salts.

From a consideration of ammonia, hydrazine, and hydroxylamine as the parent substances of systems of acids, bases, and salts it is possible to regard all reactions of these three substances with nitrous acid as involving first, formation of an addition product with nitrous acid, secondly, subsequent solvolytic action of each upon nitrous acid with resultant formation of intermediate compounds which, from the Franklin point of view, may be looked upon as mixed acids, derivable from both the water system and the corresponding parent solvent. Such a reaction mechanism is obvious enough where organic compounds are used since the intermediate products are usually stable and may be isolated. However, those reactions which involve the interaction of nitrous acid with ammonia, hydrazine, and hydroxylamine, with the subsequent decomposition of the resultant nitrites, yield intermediate products which are so unstable that only in the case of hydroxylamine nitrite has it been possible to follow the course of the reaction qualitatively.

The decomposition of ammonium nitrite undoubtedly involves initial ammonolysis of nitrous acid with formation of hydroxydiimide,  $\text{HN}:\text{NOH}$ , or its tautomer, *nitrosoamine*,  $\text{H}_2\text{N}\cdot\text{NO}$ , both of which are formally mixed *aquo-ammono-nitrous* acids.

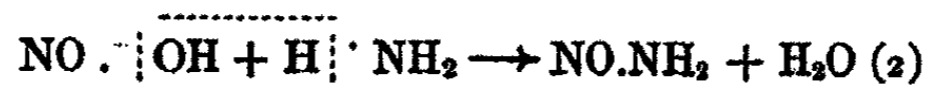
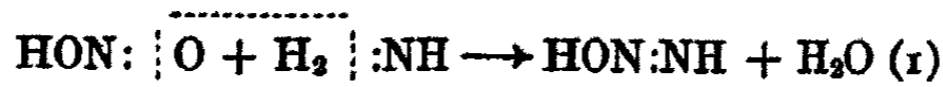

The parallel of (1) is to be found in the action of nitrous acid upon primary aryl amines, where the structural analogues of hydroxydiimide, which may be regarded as the type substance of the large group of diazo compounds,

are stable. Like the parent substance, but to a lesser degree, these intermediates readily split off nitrogen with formation of hydroxy derivatives.



Stable nitrosoamines are formed only when nitrous acid acts upon secondary amines. Nitrosoamines derived from primary amines have been prepared, but undergo ready rearrangement to the more stable diazo structures:  $\text{RNH} \cdot \text{NO} \longrightarrow \text{RN}:\text{NOH}$ .

Of particular interest have been those reactions which involve the formation of hydrazoic acid and azides from derivatives of nitrous acid and hydrazine. A. W. Browne and his students have investigated this problem carefully and have come to the conclusion that "hydrazoic acid may be looked upon as a *hydrazonitrous* acid, a nitrous acid of the hydrazine system, experimentally obtainable by the *hydrazinolysis* of nitrous acid, either in aqueous or in non-aqueous solutions, and derivable by dehydrazination of normal hydrazonitrous acid,  $\text{N}(\text{N}_2\text{H}_5)_2$ ."<sup>1</sup>

The partial hydrazinolysis of nitrous acid, however, leads theoretically to the formation of two mixed *aquo-hydrazo-nitrous* acids, at least one of which is known in the form of its organic derivatives.

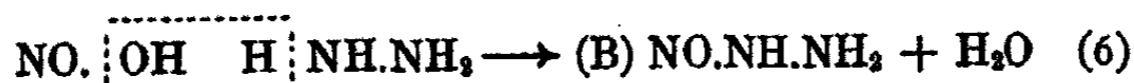
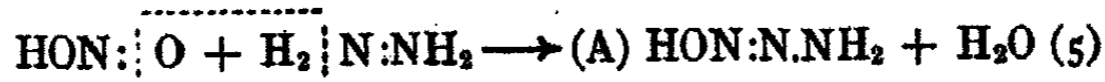

The intermediate existence of 1-hydroxytriazene (A) has been postulated by Angeli<sup>2</sup> to account for the formation of silver azide from silver nitrite and hydrazine sulfate. This theory is in accord with the views expressed by Wieland<sup>3</sup> who would compare the decomposition of 1-hydroxytriazene to yield hydrazoic acid to the stabilization of alkyl diazo compounds, as expressed by the following equations:



Although no derivatives of 1-hydroxytriazene are known, those of *nitrosohydrazine* form a large and interesting group. Aryl and alkyl nitrosohydrazines, when heated in inert solvents, break down readily to give nitrous oxide and the corresponding amine. If this decomposition is permitted to

<sup>1</sup> J. Am. Chem. Soc., 48, 682 (1926). To quote further: "That hydrazoic acid must be in some way related structurally to nitrous acid seems inevitable from the multiplicity of methods for obtaining it from nitrous acid or its derivatives as described by various investigators. All these methods involve the use of some compound or derivative of hydrazine, a substance shown to be a dissociating solvent comparable in scope and character with ammonia and water, and like these substances constituting the basis of a system of acids, bases, and salts."

<sup>2</sup> Chem. Centralbl., 1893 II, 559.

<sup>3</sup> "Die Hydrazine," 17 (1913).

take place in acid or in alkaline solution the corresponding azides are obtained. Hydrazine nitrite<sup>1</sup> gives nitrous oxide, ammonia, and water on thermal treatment, a behaviour which suggests the intermediate formation of nitrosohydrazine itself. (Equation 6.) If, however, the formation of hydrazine nitrite is permitted to take place in acid solution, as in the experiments performed by Angeli and by Dennstedt and Göhlich,<sup>2</sup> a variety of products is obtained, among them always hydrazoic acid. In the latter case a rearrangement of nitrosohydrazine into its tautomer, 1-hydroxytriazene, seems plausible enough when it is considered that the nitroso group is attached to a primary amine radical.



Such a change is furthermore in accord with the findings of Hendricks and Pauling<sup>3</sup> who have demonstrated that the azide ion possesses a chain structure as represented in equation 8. In the case of the aryl and alkyl nitrosohydrazines, to which the structure  $\text{RN(NO)NH}_2$  has been assigned, such a rearrangement cannot be considered. It would seem highly probable that the cyclic structure for the azide radical first proposed by Fischer<sup>4</sup> still holds for compounds with non-polar linkage, as in the case of the organic azides.

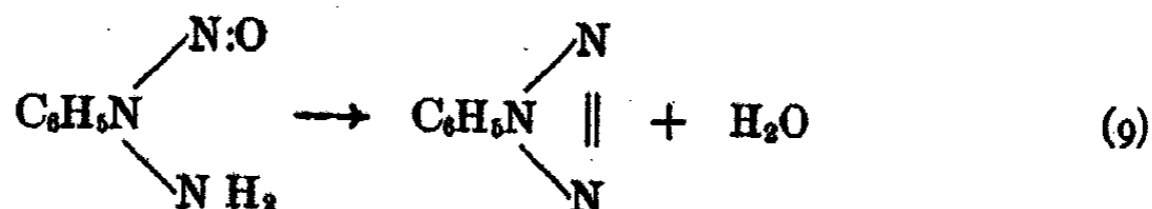

#### Hydroxylamine and its Relation to Hyponitrous Acid

Like ammonia, water, and hydrazine, hydroxylamine may also be considered as the parent substance of a system of compounds. It has been shown to possess very definite solvent properties, and has been found to form solvates with many inorganic salts. Many compounds are known which bear to it a structural relationship similar to that which the usual acids and bases do to water.<sup>5</sup>

From the host of methods known which depend upon the preparation of hyponitrites from derivatives of hydroxylamine and of nitrous acid, it seems probable that initial solvolytic action of hydroxylamine upon nitrous acid takes place with formation of either *dihydroxydiimide* (A) or *nitrosohydroxylamine* (B), both of which are formally mixed *aquohydroxylamino-nitrous acids*.

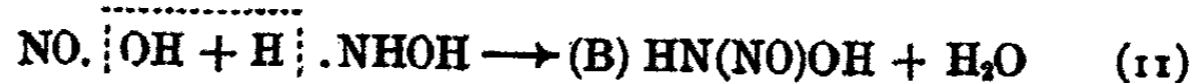
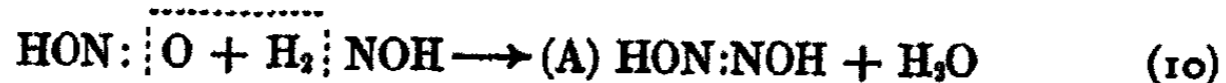

<sup>1</sup> Sommer: Z. anorg. Chem., 83, 119 (1913).

<sup>2</sup> Chem. Ztg., 21, 876 (1897).

<sup>3</sup> J. Am. Chem. Soc., 47, 2904 (1925).

<sup>4</sup> Ann., 190, 67 (1878).

<sup>5</sup> A paper pointing out these analogies was presented by the author at the Macomb meeting of the Illinois State Academy of Sciences in May, 1929, and will be published in the Proceedings of the Society.



From analogy with the behaviour of the hydroxylamine salts of organic acids, which split off water to give the corresponding hydroxamic acids, Jones and Scott<sup>1</sup> reason that this group of methods for preparing hyponitrites involves the decomposition of hydroxylamine nitrite to give the hydroxamic acid of nitrous acid (B), which is in tautomeric relationship with the hydroximic form (A). That the true structure of hyponitrous acid is represented by the usual dihydroxydiimide formula again seems more likely in view of the tendency for the nitroso group to go over to the more stable oxime grouping when possible. Nitrosohydroxylamines are obtainable only when the imide hydrogen has been replaced by a stabilizing radical, as in the case of  $\beta$ -phenylnitrosohydroxylamine. The addition product obtained when potassium sulfite reacts with nitric oxide may be regarded as the potassium salt of nitrosohydroxylaminosulfonic acid and yields potassium hyponitrite on treatment with potassium hydroxide.

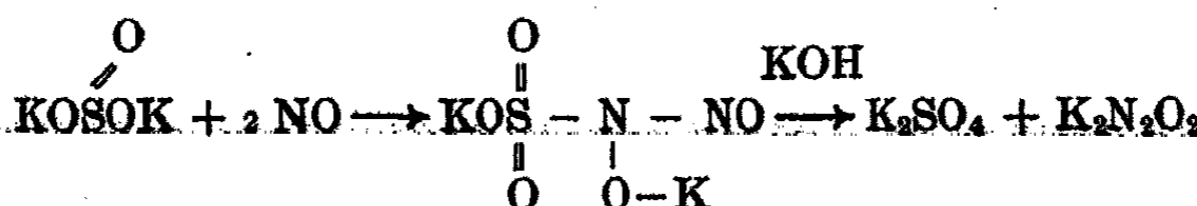

#### Decomposition of Hydroxylamine Nitrite

Hydroxylamine salts and sodium nitrite react in aqueous solution at ordinary temperatures with the formation of nitrous oxide.<sup>2</sup> The intermediate formation of both hydroxylamine nitrite and hyponitrous acid has been postulated, but the rapid decomposition of both at ordinary temperatures precludes their detection. At room temperatures concentrated solutions of barium nitrite and hydroxylamine sulfate react with the formation of barium sulfate and nitrous oxide. If, however, this reaction<sup>3</sup> be permitted to take place at 0° C precipitation of barium sulfate takes place, but no gas evolution. The resulting filtrate is strongly acid and gives tests for both hydroxylamine and the nitrite ion. It may therefore be inferred that hydroxylamine nitrite has been formed and that this substance is stable in aqueous solution at 0° C. for a short length of time.

After several hours such a solution begins to evolve gas. The addition of silver nitrate gives a white precipitate which has a slight yellowish tinge due to the presence of white silver nitrite contaminated with a small amount of yellow silver hyponitrite. The quantity of silver hyponitrite obtained increases until after 4-6 hours a maximum conversion of hydroxylamine into hyponitrous acid has taken place. In none of the experiments was the yield of hyponitrite, based upon the amount of hydroxylamine sulfate used, found to be in excess of 1.35%. After the maximum point has been reached the amount of hyponitrous acid decreases slowly until no more can be detected

<sup>1</sup> J. Am. Chem. Soc., 46, 2172 (1924).

<sup>2</sup> V. Meyer: Ann., 175, 141 (1875).

<sup>3</sup> The  $(\text{NH}_2\text{OH})_2\text{H}_2\text{SO}_4$  must be carefully purified and all excess acid removed, otherwise immediate decomposition sets in, even at 0° C.

in the solution. Hyponitrous acid has been shown to be very unstable in aqueous solution and in the above experiments its rapid decomposition is probably due to the presence of free nitrous acid, formed by the hydrolysis of hydroxylamine nitrite. Details of a typical run follow:

Six and five-tenths grams of  $\text{Ba}(\text{NO}_2)_2 \cdot \text{H}_2\text{O}$  in 15 cc. of water at  $0^\circ\text{C}$ . were added to 4.1 g. of  $(\text{NH}_2\text{OH})_2 \cdot \text{H}_2\text{SO}_4$  dissolved in 10 cc. of water. The precipitated  $\text{BaSO}_4$  was allowed to settle, then filtered off, care being taken to keep the solution at  $0^\circ\text{C}$ . The filtrate was diluted to 250 cc. and 25 cc. portions were pipetted out from time to time and the hyponitrite content determined.<sup>1</sup> The results are given in Table I. Column 2 gives the amount of silver hyponitrite equivalent to the hyponitrous acid contained in 25 cc. of the solution.

TABLE I  
Conversion of Hydroxylamine Nitrite into Hyponitrous Acid in Aqueous Solutions at  $0^\circ\text{C}$ .

Time in Hours	Weight of $\text{Ag}_2\text{N}_2\text{O}_2$	Percentage Yield	Time in Hours	Weight of $\text{Ag}_2\text{N}_2\text{O}_2$	Percentage Yield
1.0	—	—	7.5	.0123	0.88
3.0	0.0161 g.	1.16%	9.0	.0109	0.78
4.5	.0150	1.08	10.5	.0073	0.53
6.0	.0126	0.90	12.0	.0046	0.33

Rise in temperature accelerates the rate of decomposition of hydroxylamine nitrite. If a freshly prepared solution be heated rapidly to  $50^\circ\text{C}$ . copious gas evolution takes place. The addition of silver nitrate results in the formation of the characteristic yellow precipitate of silver hyponitrite.

#### Summary

Experimental evidence has been presented which indicates that the decomposition of hydroxylamine nitrite may be regarded as involving initial solvolytic action of hydroxylamine upon nitrous acid with the intermediate formation of hyponitrous acid, a *hydroxylamino-nitrous acid*. A similar sort of a reaction mechanism may be postulated for the decomposition of ammonium nitrite and hydrazine nitrite, but the intermediate products are in these two cases so unstable that their isolation is precluded.

Department of Chemistry,  
University of Illinois,  
Urbana, Illinois.

<sup>1</sup> No satisfactory method is given in the literature for the determination of the hyponitrite radical in the presence of nitrites and hydroxylamine. The method used by the author, which gives results which are reproducible to within one per cent for quantities where no more than 30 mg. of  $\text{Ag}_2\text{N}_2\text{O}_2$  are obtained, makes use of the comparative insolubility of silver hyponitrite in solutions slightly acid with acetic acid. When very dilute solutions are employed the silver salt is precipitated in very finely divided form; more concentrated solutions give a flocculent precipitate. Exposure of the silver salt to light is to be avoided. Drying of the precipitate is best accomplished in a vacuum drying oven at temperatures not to exceed  $60^\circ\text{C}$ .

## STUDIES ON PHOSPHORIC ACID\*

### II. Compound Formation between Ortho Phosphoric Acid and Certain Acidic Organic Compounds

BY JAMES H. WALTON AND RAYMOND J. KEPFER

The tendency of sulfuric acid to form molecular complexes with many other compounds has been shown by the senior author of this paper to be of great importance in explaining the decomposition of certain compounds by treatment with concentrated sulfuric acid. The compounds investigated were formic,<sup>1</sup> malic,<sup>2</sup> and triphenyl acetic<sup>3</sup> acids.

In an investigation of the decomposition of formic acid by phosphoric acid it has been shown that the tendency of formic acid to form addition compounds would explain in a similar manner the dehydration of the formic acid.

The present investigation was undertaken to show the tendency of compound formation between phosphoric acid and certain organic compounds. The method of investigation used was the one described by Knox and Richards.<sup>4</sup> This method is based on the fact that when certain strong acids are added to solutions of a weak acid the solubilities of the latter at first decrease because of the common ion effect of the hydrogen ions. In certain cases, depending on the relative strengths of the two acids, the decrease in solubility takes place with increase in concentration up to a certain point only, after which an actual increase in solubility occurs. This increase in solubility is due to the formation of oxonium compounds, consequently solubility curves may be used to detect compound formation. The method is limited by the solubilities and the relative strengths of the acids used.

#### Experimental

The ortho acid used was the ordinary syrupy phosphoric acid (85% Sp. Gr. 1.710). Oxalic, succinic, and citric acids were purified by recrystallization. Malic acid was a d-l mixture prepared by Eastman. This acid however was not entirely pure, for it had a slight burnt odor and a melting point of 125°-128° after recrystallization. The iso-valeric acid was distilled between 175° and 178°. The phenol distilled between 182.5° and 183°.

*Method of Experimentation.* About 20 cc of the solution of the solvent acid was placed in a large test tube together with an excess of the solute acid. The mixture was then heated to about 50° and agitated fairly vigorously for

\* Contribution from the Laboratory of General Chemistry of the University of Wisconsin.

<sup>1</sup> Schierz: J. Am. Chem. Soc., 45, 447 (1923).

<sup>2</sup> Whitford: J. Am. Chem. Soc., 47, 953 (1925).

<sup>3</sup> Dittmar: J. Phys. Chem., 33, 533 (1929).

<sup>4</sup> Knox and Richards: J. Chem. Soc., 115, 508 (1919).

a few minutes in order to nearly saturate the solution at that temperature. The tube was then placed in a thermostat at 25°, the contents stirred for several hours, and the saturated solvents then allowed to separate from the excess solute. In the case of citric, malic, and the more concentrated solutions of succinic acid, a complete separation did not take place within a reasonable length of time so the solutions were filtered at the temperature of the thermostat. 2 or 5 cc. portions were drawn into a pipette and analyzed.

*Method of Analysis.* Three different methods of analysis were employed. For the run with phenol the amount of phosphoric acid present was determined by titration with standard sodium hydroxide solutions. The phenol was then determined by a method outlined by Redman, Worth, and Brock.<sup>1</sup>

For all other combinations the total acidity was determined with standard sodium hydroxide using phenolphthalein as an indicator and comparing the final end-point color with that produced when phenolphthalein was added to a solution of disodium phosphate. With oxalic acid the amount of solute present was determined by an ordinary potassium permanganate titration and the phosphoric acid by the difference between the total acidity and acidity due to the oxalic acid. For the other solutes, citric, succinic, malic, and isovaleric acids, the amount of phosphoric acid was determined gravimetrically. The amount of solute was then determined by difference between the total amount of acidity and the acidity due to this amount of phosphoric acid.

#### Discussion

*Results with Phosphoric Acid.* The results of the above experiments are given in Table I and are also represented graphically in Figs. 1-3. Of the various possible methods for expressing concentrations the one used by Knox and Richards, namely, normalities of the two acids in the resulting solution, has been chosen. The normalities given are an average of two determinations in each case.

Since in all cases the solvent differed in strength from the solute two types of curves might be expected. (1) If, as has been shown by James Kendall, the solute acid is strong there is little tendency for compound formation to take place between the two acids. However since water can be regarded as a weak acid it will tend to form an addition compound with a stronger acid and thus hydration of the solute will result. Two factors, common ion effect and hydration of the solute will then tend to reduce the solubility of the solute acid. On the other hand there will be only a feeble tendency to compound formation and hence only slight cause for increased solubility. Consequently for acids of *this type* one would expect to obtain curves which show only a slight rise as the solvent acid becomes very concentrated. This was found to be the case with citric and malic acids. The citric acid curve makes no turn whatsoever so far as determined, but no doubt there would be a slight indication of compound formation if a more concentrated solution of phosphoric acid had been used. This will be more clearly

<sup>1</sup> J. Ind. Eng. Chem., 5, 389 (1913)

TABLE I  
Normalities\* of the Solvent and Solute when Varying Concentrations of the Solute are Saturated with the Solute

Sample No.	1.	2.	3.	4	5.	6.	7.	8.	9.	10.
					Citric Acid					
$C_6H_8O_7$	12.54	9.88	6.61	5.23	2.89	1.20	1.02	0.96	0.92	
$H_3PO_4$	—	5.32	13.02	16.61	23.44	33.14	34.92	36.10	39.70	
					Malic Acid					
$C_4H_6O_5$	11.06	8.88	4.74	4.48	3.68	3.02	2.70	2.72	2.82	2.95
$H_3PO_4$	—	4.96	15.44	16.76	20.08	23.23	28.94	32.10	35.81	38.15
					Oxalic Acid					
$C_2H_2O_4$	2.412	2.020	1.383	1.025	0.699	0.571	0.575	0.768	1.121	1.504
$H_3PO_4$	—	3.14	8.85	13.36	19.51	24.98	30.55	35.44	38.62	40.15
					Succinic Acid					
$C_4H_6O_4$	1.347	0.78	0.48	0.50	0.30	0.28	0.28	0.38	0.36	0.49
$H_3PO_4$	—	7.38	14.31	19.69	25.38	31.05	34.64	37.79	40.95	43.96
					Iso-Valeric Acid					
$C_5H_{10}O_2$	0.467	0.26	0.18	0.15		0.10	0.11	0.15	0.21	0.39
$H_3PO_4$	—	7.67	13.84	19.43		28.39	32.16	35.72	39.15	42.82
					Phenol					
$C_6H_6O$	0.900	0.441	0.281	0.215	0.177	0.155	0.152	0.156		
$H_3PO_4$	—	7.65	14.47	20.16	26.38	31.81	35.25	37.47		

\* Values recorded are an average of two determinations.

shown later when a comparison with the solubility of citric acid in sulphuric acid is made.

(2) As the solute acid becomes weaker the tendency towards compound formation becomes stronger while the amount of hydration usually decreases, hence for these weaker solute acids curves which make more of a turn at higher concentrations of the solvent acid would be expected. Again as can be seen from Figs. 1 and 3 the results are in general in accord with what one would predict. Succinic, oxalic, and iso-valeric acids all show compound formation. There does however seem to be some inconsistency in the case of

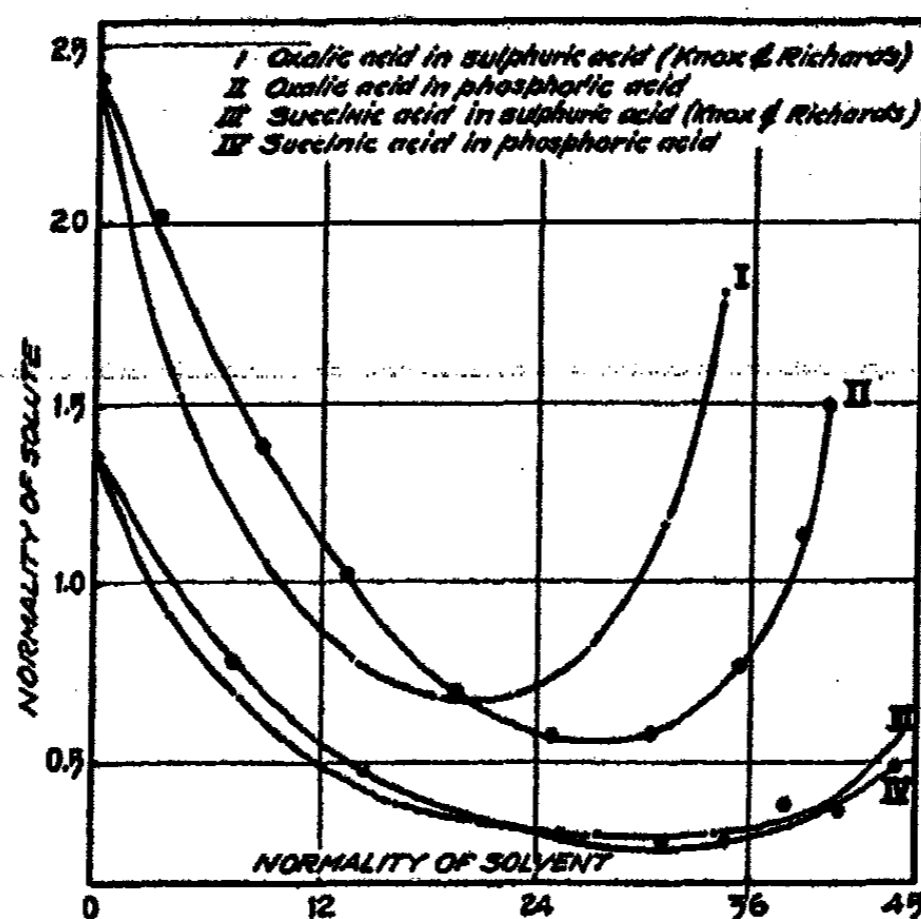

FIG. 1

phenol. Since this is a very weak acid one would expect it to show extensive compound formation but the curve makes only a slight turn. However this can be at least in part attributed to the fact that the run was not made in as high a concentration of phosphoric acid as in the other cases. This was due to the fact that at concentrations of the phosphoric acid greater than 37 or 38 normal crystallization took place, evidently due to the compound formation found by Hoogewerff and van Dorp,<sup>1</sup> so that runs could not be made. However the curve was turning up at 36 or 37 normal so there seems to be no doubt but that distinct compound formation would have been indicated had it been possible to work on up to 41 or 42 normal solutions of phosphoric acid. It should also be possible to obtain further information on the subject by making the complete run at some higher temperature at which crystallization would not take place so readily.

It is evident that the results agree with the general rule formulated by Kendall<sup>2</sup> in his study of the addition compounds of acids by the method of

<sup>1</sup> Rec. Trav. chim., 21, 349 (1902).

<sup>2</sup> J. Am. Chem. Soc., 43, 1545 (1921).

freezing point curves. If there is a great difference in the acidic strength of the components used there are strong indications of compound formation, while for components with less difference in acidic strength the indications of compound formation are weaker.

In all cases the turn does not come until after the solvent acid is highly concentrated. This would seem to indicate that the addition compound is highly dissociated in water solutions, and true addition does not take place until the relative concentration of the water has been greatly reduced. From

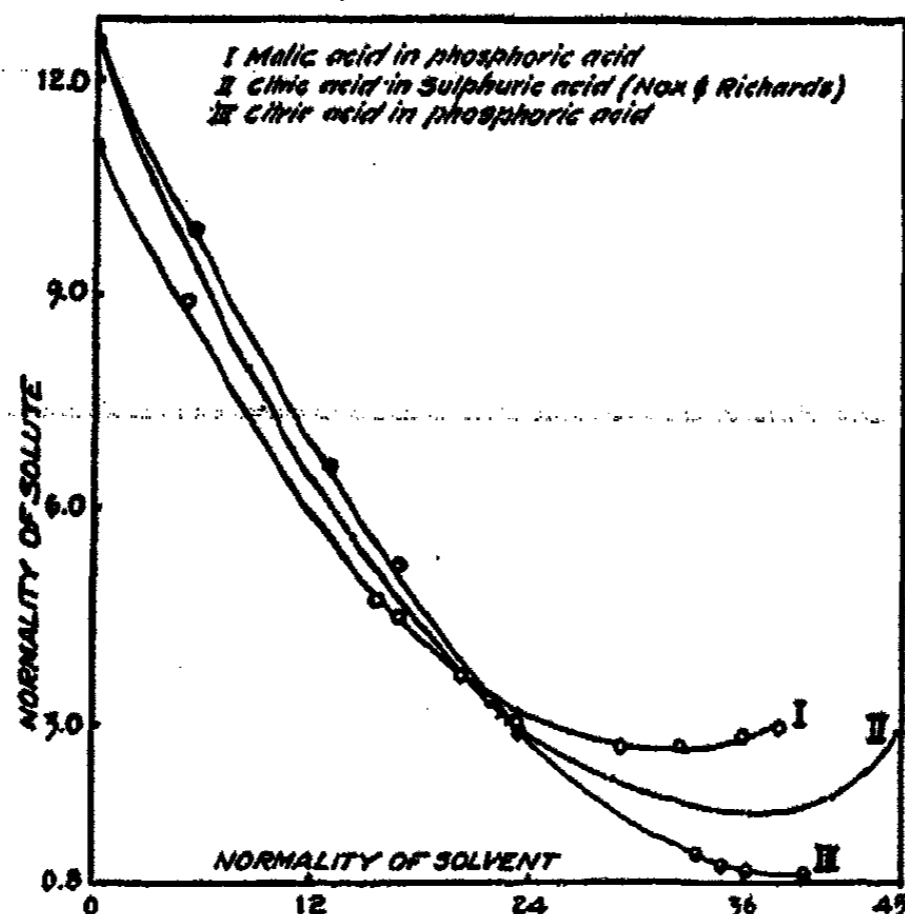

FIG. 2

what has been said concerning the weak acidic property of water and thus the tendency for hydration of the solute acid to take place, this would be expected.

*Comparison of Phosphoric and Sulphuric Acids.* To compare the solubilities obtained with citric, succinic, and oxalic acids in phosphoric acid with the corresponding values obtained by Knox and Richards in sulphuric acid, the values for solubility obtained by Knox and Richards have been plotted in Figs. 1 and 2 with the corresponding phosphoric acid curves. For the sake of convenience in plotting, the normalities of the sulphuric acid have been multiplied by two.

The similarity of phosphoric and sulphuric acids as to tendency to form addition products is very clearly illustrated for in all cases the curves are very nearly duplicates. This is evidence for assuming that the solubility of citric acid in phosphoric would have increased had a higher concentration of phosphoric acid been used.

It will also be noticed that, in all three cases, the minimum solubility of the acids in question is slightly less in phosphoric acid than it is in sulphuric acid and is always reached at a lower concentration of sulphuric acid

than of phosphoric acid. This is no doubt due to the fact that the tendency to form addition compounds is slightly less with phosphoric acid than with sulphuric acid, which is what one would expect, since there is not so much difference between the acidic strengths of the organic acids used and the phosphoric acid as there is between these same acids and sulphuric acid. This is likewise in accordance with what Knox and Richards found concerning nitric, hydrochloric, and sulphuric acids. Finally, the first part of the curve with sulphuric acid always falls below that with phosphoric acid. This

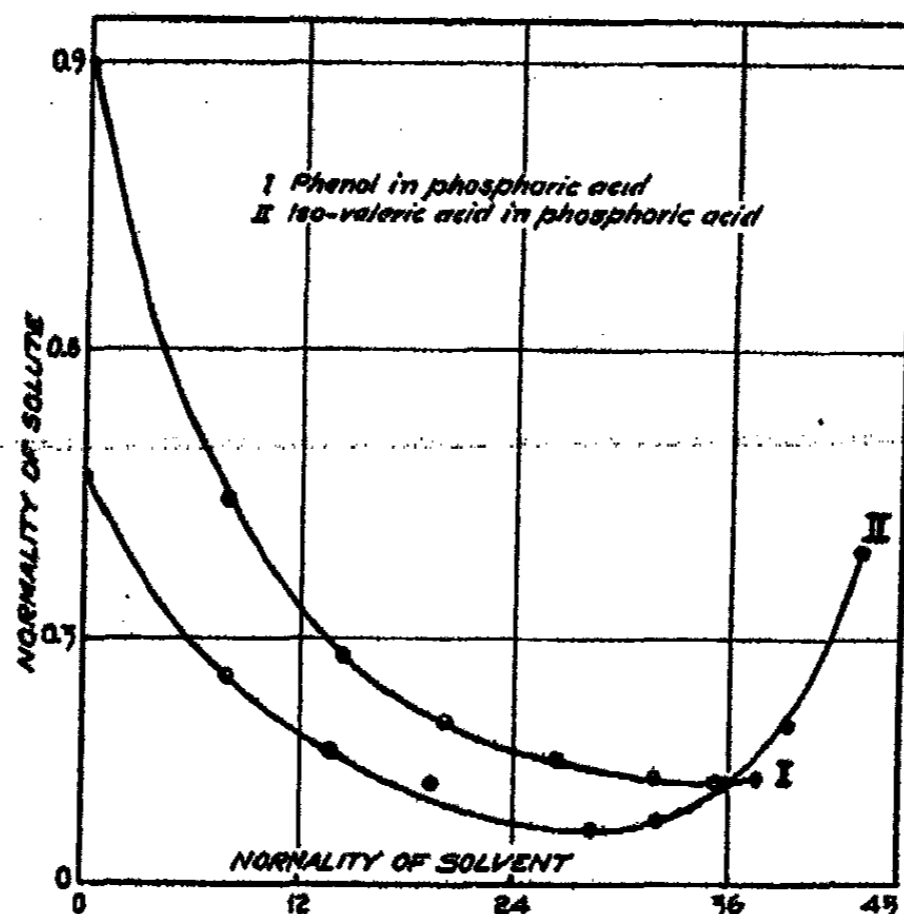

FIG. 3

can be attributed to the fact that for the same concentration the sulphuric acid is much more highly ionized and therefore its common ion effect is much more pronounced than that for phosphoric acid.

#### Summary

1. The solubilities of phenol and of citric, malic, oxalic, succinic and iso-valeric acids in ortho phosphoric acid solutions of various concentrations have been determined.

2. With the above compounds there are indications of the formation of addition compounds with phosphoric acid which can be explained by the formation of oxonium compounds.

3. Phosphoric acid is very similar to sulphuric acid in its tendency to form addition compounds with the compounds investigated, the chief difference being that the former acid does not form these compounds quite so readily as does the latter acid, this difference probably being due to phosphoric acid being the weaker of the two.

Madison, Wis.



## INFLUENCE OF AGEING ON INORGANIC HYDROPHILE COLLOIDS, CELLS AND COLLOIDS IN THE ANIMAL BODY

N. R. DHAR

In a previous paper<sup>1</sup> I have advanced the view that old age is associated with marked decrease in the catalytic activity of the body enzymes and cells. Consequently in old age there is an appreciable decrease in the metabolism in the animal body. Observations on the metabolism of human beings of different ages show that the metabolism expressed per square metre of the body surface or kilogram of the body weight is less in old age than in childhood or youth.

Moreover a certain minimum quantity of heat is necessary for the maintenance of the body temperature. I am of the opinion that when the amount of oxidation in the body is just less than the minimum necessary to keep up the body temperature, death is likely to follow. Animal life is assumed to depend essentially on the activity of the cells and enzymes.

In this paper I shall bring forward further evidence in support of the above views and show that the phenomenon of ageing is common both to inorganic and organic colloids and precipitates.

In publications<sup>2</sup> from these laboratories we have shown that the activity, adsorptive power, stability and viscosity of hydrophobe colloids decrease with time. On the other hand, with hydrophile colloids, the viscosity and the amount of hydration increase up to limiting value on ageing.

In a recent communication we have shown that the viscosity of a sol of ceric hydroxide prepared in the cold goes on increasing with time up to a limiting value and then it sets to a stiff jelly. Now if the jelly is kept in a stoppered bottle the viscosity decreases and the sol becomes mobile again. The electric conductivity of the sol goes on decreasing up to a minimum value and then it increases. Exactly similar results are obtainable with a sol of vanadium pentoxide. In this case we prepared a concentrated sol and measured the conductivity and viscosity day to day and found that the viscosity goes on increasing up to a limiting value and then it decreases with time. The electrical conductivity, on the other hand, goes on decreasing up to a minimum and then it increases again. These two sols behave as typical hydrophile colloids. With silicic acid some interesting results have been obtained. The sol prepared both in the cold and hot conditions show increased viscosity with time and on keeping the silicic acid sets to a jelly. In course of time the jelly is broken and a portion of the liquid is given out.

Exactly similar behaviour is observable with animal cells and protoplasm. From ultramicroscopic observations it can be clearly concluded that amoeba

<sup>1</sup> J. Phys. Chem., 30, 378 (1926).

<sup>2</sup> Z. anorg. allgem. Chem., 162, 237; 164, 63 (1927); Kolloid-Z., 42, 120 (1927).

consists of colloidal particles. Similar conclusions are drawn by Mott<sup>1</sup> from observations on living nerve cells by the same method. As a general rule the small granules often seen in living cells do not show active Brownian movement indicating that protoplasm is often of considerable viscosity. This is in harmony with the fact that it can often be drawn into long sticky threads.

The degenerative changes which precede the death of a cell are accompanied by a liquefaction of the protoplasm and by the appearance of small granules in active Brownian movement. These granules become larger in course of time whilst the Brownian movement ceases and this indicates that the protoplasm has irreversibly coagulated.

The protoplasm of young cells is often homogeneous, whilst that of the mature cell may show a definite structure. Thus immature eggs of Echinoderms are quite clear and transparent, whilst in the mature eggs, Chambers<sup>2</sup> distinguishes two kinds of particles visible in the ordinary microscope—very small ones, and larger ones, macrosomes. The former are stable and the latter very sensitive to injury. Mitochondria are granules apparently composed of albumin and lecithin which stain with dyes containing di-ethyl safranin. They are present in the living cell and modify the activities of the cell. It appears therefore that the protoplasm of young cells behaves like a freshly prepared colloidal solution and in the mature egg partial separation of the solid and increased capacity are observable due to ageing. This behaviour of protoplasm is similar to that observed with a sol of silicic acid. Fischer has shown that the same type of change takes place with proteins. Gelatine jelly, as well as other protein media, as the familiar blood serum of the bacteriologists all squeeze off fluid on standing. The more highly hydrated the protein gel or jelly, the more liquid is squeezed off. Hence it appears that in course of time the body proteins have a tendency to lose their adsorptive power and activity. This is one of the important factors that lead to old age and death. The cells of the tissues are like other living beings dependent for their life and activity upon a constant and abundant supply of food, and oxygen and an equally adequate removal of their waste products. Now the utilization of food and oxygen is possible because of the existence of catalysts in the body. In course of time the activity of the enzymes as well as that of the cells is decreased and hence the metabolism is decreased.

In previous communications from these laboratories we have shown that hydrophobe colloids like ferric hydroxide, aluminium hydroxide, etc., show greater conductivity on ageing and their viscosity becomes less and less with time. Now the particles of these colloids in course of time grow into bigger ones and hence the surface of the particles becomes less and less and along with the decrease in the surface the adsorptive power, the amount of hydration and the viscosity decrease. The adsorbed electrolyte is thus given out and the conductivity of the sol taken as a whole is increased. Exactly similar behaviour is observable with solutions of ferric chloride, aluminium nitrate,

<sup>1</sup> "The Brain and the Voice in Speech and Song," 112 (1912).

<sup>2</sup> J. Exp. Zool., 23, 483 (1917).

thorium nitrate, alums etc. All these salts when dissolved in water are hydrolysed into a base which is sparingly soluble and this base will exist in a colloidal state by the adsorption of the acid and the metallic salt solution. The particles of this colloid in course of time will agglomerate and lose part of its adsorbed electrolyte and hence the electrical conductivity will increase and the viscosity and stability will decrease. In the case of solutions of sodium or potassium palmitate, stearate, etc., by hydrolysis we get an acid which is sparingly soluble. In these cases also the particles of the sparingly soluble acid will lose a part of their free surface and the adsorbed electrolyte. But the particles of sodium or potassium stearate, palmitate etc. have great affinity for water and hence in course of time these particles will be more and more hydrated and the viscosity will increase up to a maximum value. The electrical conductivity will decrease up to a limiting value and then it will increase again.

In the case of vanadium pentoxide the sol shows increased viscosity and decreased conductivity with time up to a limiting value. This is because vanadium pentoxide has a great affinity for water, and it will combine with more and more water and hence the viscosity will increase and along with it the electrical conductivity will decrease up to a limiting value. This hydration tendency of substances like vanadium pentoxide, ceric hydroxide, silicic acid, etc., depends upon the affinity of the substances for water and is possibly controlled by those forces which make substances dissolve in water. Now when the chemical affinity of the particles of vanadium pentoxide, ceric hydroxide, etc., for water is satisfied and the maximum hydration and viscosity are reached, the particles on further ageing begin to agglomerate and partially lose their adsorptive power, stability, and hydration tendency. Our experimental results on the viscosity of gelatine show that the viscosity goes on increasing with time up to limiting value and then it decreases. Hence with gelatine the viscosity and the hydration tendency increase up to maximum and then they fall off due to ageing.

Typical animal products like albumin, gelatin, protoplasm, cells etc. also behave in a similar manner as has already been mentioned. From the above results it will be clear that there is no essential difference between inorganic hydrophile colloids and typical animal products like albumin, protoplasm etc. The ageing phenomenon is similar in both these groups of substances.

It is well known that Dony-Hénault prepared artificial laccase, which is an oxidising enzyme by alcoholic precipitation of a solution containing gum arabic, manganese formate and sodium bicarbonate. This precipitate can be redissolved in water and reprecipitated by alcohol. It is undoubtedly an adsorption compound with gum and colloidal manganese hydroxide. This artificial enzyme will age in course of time and partly lose its activity.

In publication from these laboratories we have shown that iron salts and colloidal ferric hydroxide can act as active catalytic agents in oxidation reactions. Thus the oxidation of tartaric acid, starch, etc., by hydrogen peroxide can be largely increased by ferric or ferrous salts or colloidal ferric hydroxide and in this way we have explained the internal use of iron in medi-

cine. Now it is well known that animal blood contains iron and that a good deal of oxidation of food material takes place in blood. It seems likely that in course of time the iron compound present in adult animal blood will lose a part of its catalytic influence and the amount of oxidation in the animal body is likely to decrease with age.

Moreover the inorganic salts which are present in the body as adsorbed by the protein matter are likely to be partly given up due to the ageing of the protein particles. Now the body cells, enzymes, hormones, internal secretions, etc., are likely to act with the help of the adsorbed inorganic and organic substances; but in course of time the adsorbed substances are likely to be given up and hence the activity of the cells, the enzymes etc. will decrease. The cartilages, connective tissues, bone cells, etc., which consist mainly of calcium carbonate and phosphate will also age in course of time and partially lose their activity and adsorptive power. In a foregoing paper<sup>1</sup> I have suggested that bone formation takes place by the adsorption of calcium phosphate and calcium carbonate existing in the colloidal state in the body by the solid or semi-solid cartilages, bones, etc. Now in the course of time the adsorbents, like cartilages, bones, etc., will partly lose their adsorptive power and would not be able to adsorb the requisite amounts of sols of calcium phosphate and carbonate from the body and hence bone formation would be difficult in old age.

Whenever an electric stimulus is sent through an Amoeba it is made to draw itself together, so that its surface shall be the least possible, in fact it becomes more or less spherical. In a recent communication from this laboratory, it has been proved mathematically that when the charge on the colloid particles is increased the particles tend to be more and more spherical. In this respect an amoeba behaves exactly like a sol. With the establishment of the cellular nature of the tissues it may well have been that the ultimate unit of life had been reached and that no minuter element need be considered. Indeed our doctrine of pathology is essentially a cellular one, although we realise that the cell in all cases is a vastly complicated structure within which there are elaborate mechanisms developed in almost infinite variety, and within which too, we can discern evidence of the accomplishment of the chemical processes which in complexity and ingenuity of combination surpass anything which can be carried on in a laboratory. From the foregoing pages it will be clear that the cells in the animal body lose their adsorptive power, hydration tendency and activity with time. It has already been mentioned that the protoplasm in the mature egg consists of two kinds of particles, small and large. The former are stable and the latter very sensitive to injury. It appears therefore, that on ageing the cells in the animal body become comparatively powerless and sensitive to injury and bacteria.

#### Summary

1) The hydration tendency and viscosity of vanadium pentoxide and ceric hydroxide increase with time up to a limiting value and then decrease

<sup>1</sup> Z. anorg. allgem. Chem., 162, 243 (1927).

and this behaviour depends on the chemical affinity of these substances for water. When the chemical affinity for water is satisfied and the maximum hydration and viscosity are reached, the particles on further ageing begin to agglomerate and partially lose their adsorptive power, stability and hydration tendency. Gelatin, albumin, etc., behave like the above two inorganic hydrophile colloids.

2) Silicic acid sol prepared in hot and cold conditions shows increased viscosity with time and on keeping the silicic acid sets to a jelly. In course of time the jelly is broken and a portion of the adsorbed liquid is given out. Similar behaviour is observable with the animal cells and protoplasm. The degenerative changes which precede the death of a cell are accompanied by the partial liquefaction of the protoplasm and by the appearance of granules. Protoplasm of young cells behave like a freshly prepared sol and in the mature egg partial separation of the solid and increased capacity are observable due to ageing. Gelatine jelly and other protein media squeeze off fluid on standing. Hence it appears that there is no essential difference in the phenomenon of ageing between inorganic hydrophile colloids and the typical animal products like albumin, protoplasm etc.

3) It appears that the enzymes, blood cells, etc., containing inorganic and organic substances will partially lose their activity on ageing and hence metabolism will decrease. The bone cells containing mainly calcium phosphate and carbonate will age with time and partially lose their adsorptive power and hence formation of new bones is difficult in old age.

4) It appears that on ageing the cells in the animal body become comparatively powerless and sensitive to injury and bacteria.

*Chemical Laboratory,  
Allahabad University,  
Allahabad, India.  
October 5, 1927.*

## CHEMICAL ACTION IN THE GLOW DISCHARGE. III. THE SYNTHESIS OF NITROGEN DIOXIDE\*

BY J. W. WESTHAVER AND A. KEITH BREWER

The direct formation of the oxides of nitrogen in the arc and in the silent electric discharge has been the subject of considerable investigation, both from the commercial and theoretical viewpoints. Little work, however, has been done on the direct synthesis of oxides of nitrogen in the glow discharge although this type of electrical discharge offers a fertile field for the study of chemical action induced by electrical phenomena. The synthesis of  $N_2O$  in a glow discharge has been described recently by Chapman, Goodman and Shepherd;<sup>1</sup> these authors also report the detection of  $NO_2$ .

It is the purpose of the present paper to describe the conditions under which  $NO_2$  may be made in the glow discharge, and to present the results obtained from a study of the rate of synthesis as dependent on the discharge current and the composition of the gas.

It was shown in two previous papers<sup>2,3</sup> on the formation of ammonia in the glow discharge that the rate of synthesis may be expressed as  $dP/dt = \alpha I$ , where  $P$  is the equivalent ammonia pressure,  $I$  is the discharge current, and  $\alpha$  is a factor that is independent of the actual gas pressure, provided the composition of the gas remains unchanged. In the present work it will be shown that the rate of synthesis of nitrogen dioxide also follows this same electrochemical equivalence law for chemical action in the glow discharge.

### Apparatus and Method

The apparatus used in this research was the same as that described in the previous papers on ammonia synthesis. The data to be presented were obtained with a discharge tube of the type illustrated in Fig. 1 of the second communication.<sup>3</sup>

A pure  $N_2-2O_2$  mixture was obtained by introducing nitrogen and oxygen into the system in as near this proportion as possible. The discharge was then started and the nitrogen dioxide frozen out until no further clean-up could be detected, after which the excess gas was pumped off. The liquid air was then removed and the nitrogen dioxide allowed to evaporate through the hot discharge, thus decomposing into a  $N_2-2O_2$  mixture. The ratio of gases so obtained was of such accuracy that the straight line relationship between time and pressure held down to a few hundredths of a millimeter.

\* Fertilizer and Fixed Nitrogen Investigations, Bureau of Chemistry and Soils, Washington, D. C.

<sup>1</sup> J. Chem. Soc., 1926, 1404.

<sup>2</sup> Brewer and Westhaver: J. Phys. Chem., 33, 883 (1929).

<sup>3</sup> Brewer and Westhaver: J. Phys. Chem., 34, 159 (1930)

The discharge was placed in a magnetic field parallel to the electric field, as in the ammonia work, to prevent the frozen nitrogen dioxide film from being decomposed by electron bombardment at the lower pressures.

### Results

The results obtained in the present research are nearly identical to those observed with ammonia, not only in their general nature, but in the magnitude of their values. A difficulty was encountered, however, that limited the study to the type of discharge in which synthesis occurred only in the negative glow.

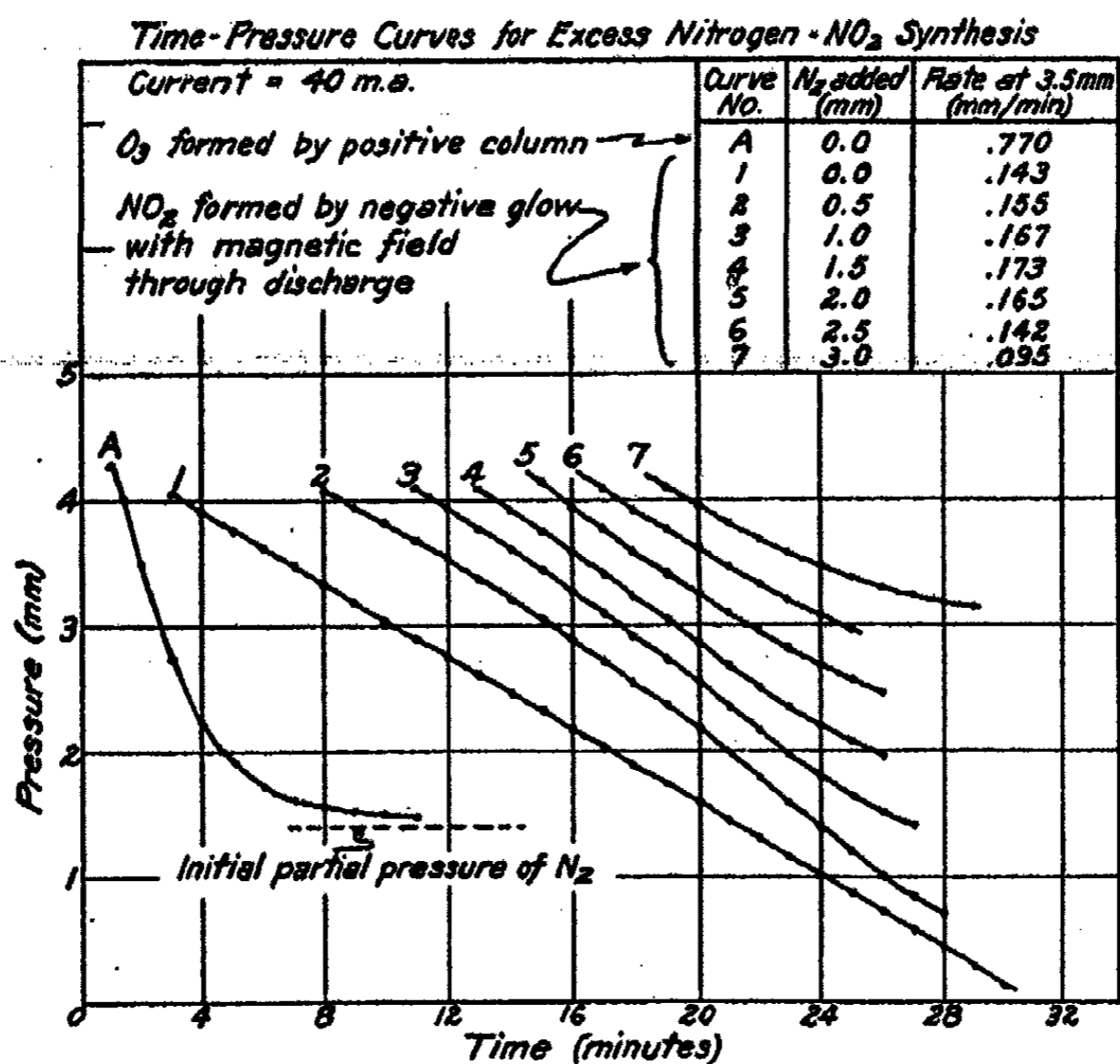

FIG. 1

tive glow. In discharge tubes wherein synthesis was possible in the positive column, as well as in the negative glow, ozone was formed along with the nitrogen dioxide. A preliminary investigation on ozone formation showed that this gas could be synthesized only in the positive column with no detectable clean-up in the negative glow. The tube illustrated in Fig. 1 of the second paper<sup>2</sup> on ammonia showed no ozone formation, while the tube illustrated in Fig. 2 of the same paper showed ozone to be formed throughout the positive column. This research, therefore, had to be confined to a study of the negative glow.

Line 1 of Fig. 1 is representative of the time-pressure curves obtained with an N<sub>2</sub>-2O<sub>2</sub> mixture. The rate, as given by the slope of the line, is independent of pressure from 4.2 mm. to 0.07 mm. in this particular case. Since the actual temperature of the gas changed from near that of liquid air at

the high pressures to near the melting point of aluminum at low pressure, the equivalent pressure or density range over which the rate of synthesis remained constant was much larger than that given by the McLeod gauge.

The effect on the rate of synthesis of changing the discharge current in a pure  $N_2-2O_2$  mixture is illustrated in Fig. 2. The points on the current-rate line were obtained from the slopes of lines similar to line 1 of Fig. 1 taken

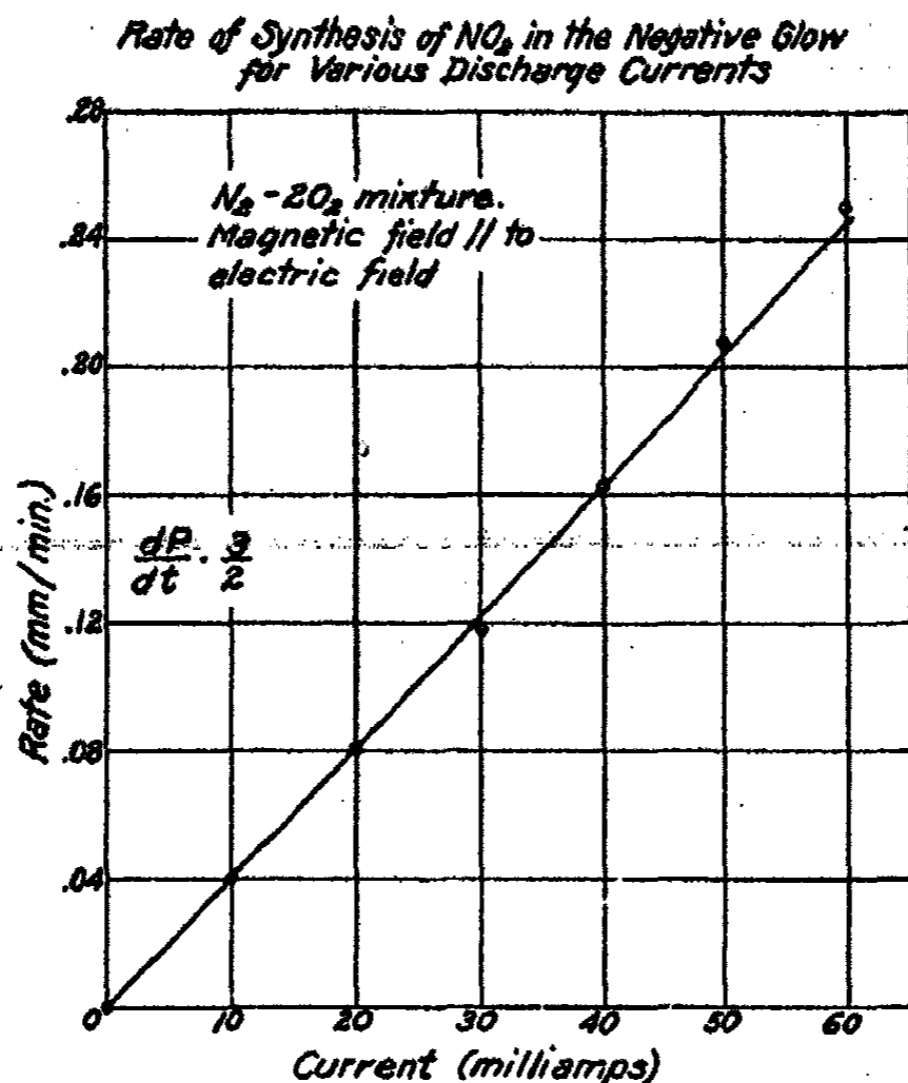

for currents of from 10 to 60 milliamperes. Direct current from a rotary converter was used as a source of power.

It will be noted that, as in the case of ammonia, the electrochemical equivalence law expressed by  $dp/dt = \alpha I$ , holds accurately throughout the range of the experiment.

The current efficiency as obtained from the slope of the line in Fig. 2 gave a value of 1.02 molecules of  $NO_2$  formed for each electron flowing through the outer circuit. Under identical conditions 0.87 molecules of ammonia were formed for each electron.

An attempt to study the rate of nitrogen dioxide synthesis in the positive column is illustrated in Line A of Fig. 1. This curve was obtained when a discharge was passed between one of the lower electrodes (C) used as an anode to one of the electrodes in the balloon flask (B), used as a cathode. Since the cathode region was not immersed in liquid air, the synthesis was confined to the positive column. The initial gas contained a partial pressure of 1.4 mm. of nitrogen. It will be seen that the "clean-up" becomes inappreciable as this pressure is approached, showing that very little nitrogen



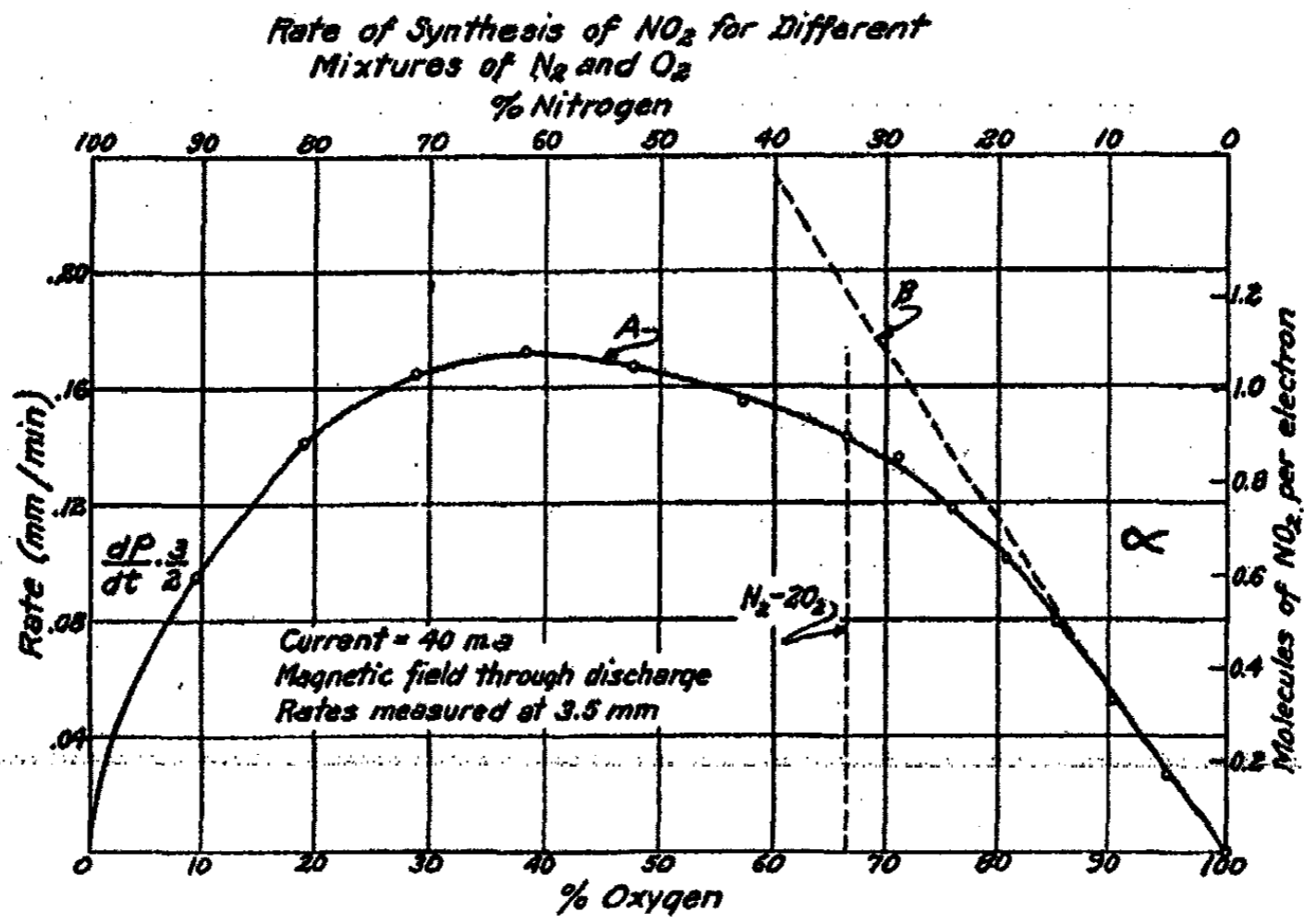

**Rate of Synthesis of NO<sub>2</sub> as Affected by the Addition of Various Gases to a N<sub>2</sub>-O<sub>2</sub> Mixture**

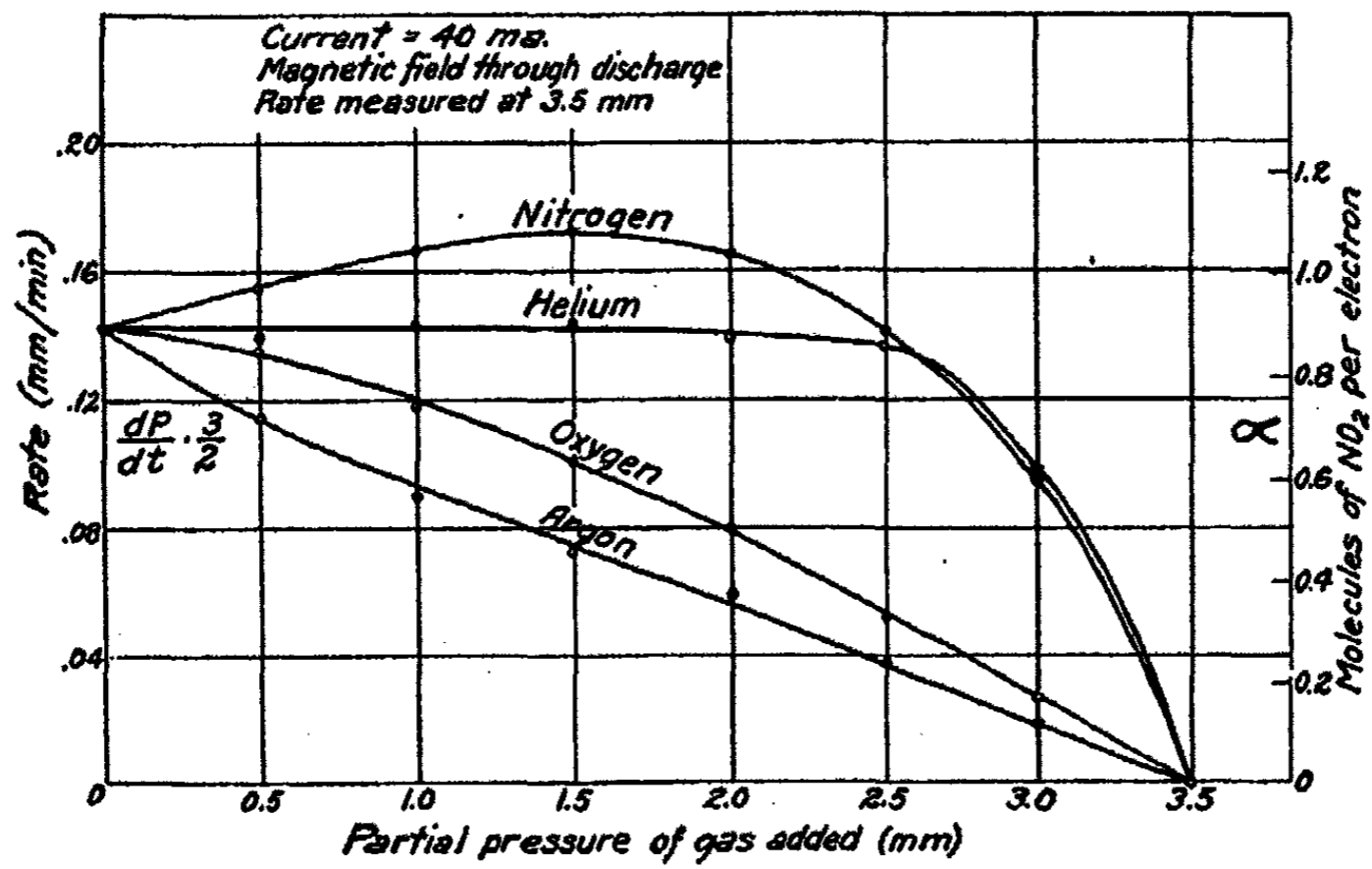

dioxide was formed during the run. The oxygen was almost completely removed in the form of ozone which appeared as a blue liquid film on the walls of the discharge chamber. It is entirely possible, however, that the rate of nitrogen dioxide formation in the positive column is of the same order of magnitude as was found for ammonia, since this was quite small compared with that in the negative glow.

The effect of various added gases on the rate constant  $\alpha$  is shown in Figs. 1, 3, and 4.

Fig. 1 shows a set of time-pressure curves taken for a group of mixtures in which  $N_2$  was in excess of the combining ratio. In taking data of this type the method followed was similar to that used previously for ammonia. A convenient amount of nitrogen dioxide was synthesized and the residual gases pumped off. The desired amount of excess gas was then introduced, after which the nitrogen dioxide was allowed to evaporate with the discharge current on. At room temperature decomposition into the elements was practically complete in a few minutes.

Sets of curves were obtained similar to those illustrated in Fig. 1, using oxygen, argon, and helium as the added gases. For comparison the slopes of these lines were measured at 3.5 mm. All runs were started at about 4.25 mm. and the composition of the gas at 3.5 mm. was calculated.

The effect of varying the nitrogen-oxygen ratio on the rate of synthesis is illustrated in Fig. 3. It will be noted that the results are analogous to those obtained in the ammonia synthesis. The substitution of oxygen for hydrogen has the effect of shifting the maximum rate, from a mixture containing about 33% nitrogen in the ammonia reaction, to about 60% nitrogen in the nitrogen dioxide reaction. The increase in the rate of synthesis by the addition of excess nitrogen is more enhanced in the present case than in the ammonia synthesis. This is again shown in line 2 of Fig. 1 as compared to the corresponding line for ammonia.

The relative effects of various added gases are given in Fig. 4. Attention should also be called to the striking similarity of these results with those obtained for ammonia. The only marked difference, as has already been pointed out, is a greater speeding up of the reaction with increase in the partial pressure of nitrogen. The zero effect of helium and the strong retarding effect of argon are again clearly illustrated.

#### Discussion of Results

A better understanding of the processes involved can be had by briefly summing up the facts brought to light in these researches.

(1) The reaction rate for a constant discharge current remains independent of pressure over as wide a range as could be investigated with the apparatus used.

(2) There is a direct proportionality between the reaction rate and the discharge current.

(3) A maximum yield of about one molecule of  $NO_2$  was obtained per electron flowing in the outer circuit.

(4) Excess nitrogen increases the reaction rate over a large composition range; excess oxygen always retards the rate; excess helium has no effect on the reaction rate for gas mixtures containing less than 70% helium; argon has a pronounced retarding action.

The most logical interpretation of these facts is that which was given previously for the synthesis of ammonia, namely, that the formation of nitrogen dioxide is initiated entirely by the positive ions formed in the discharge. Since the addition of excess nitrogen increases the rate of reaction it seems probable that the rate of production of  $N^+$  ions determines the observed reaction rates.

Further evidence that  $N^+$  is responsible for the synthesis is given by the results obtained with added argon and helium. Making the assumption, which is approximately correct, that the total positive ion production does not change with the composition of the gas, the rates given in Fig. 4 can be accounted for by variations in the  $N^+$  ion production, as derived from a consideration of the ionization potentials of the gases, and the possibility of collisions of the second kind.

The ionization potentials and stopping powers of the gases concerned are given in Table I.

TABLE I

	$N_2$	$O_2$	A	He
Ionization potential	16.8	14.1	15.7	24.5
Stopping power	8.72	9.9	8.87	1

The stopping powers were computed from the corrected data of Hughes and Klein.<sup>4</sup> The probability of ionization of a 100 volt electron multiplied by the collision frequency is taken as a measure of the stopping power. The values given are on the basis of helium being 1.0. Hughes and Klein do not give data from which the stopping power of oxygen can be calculated. The value used was computed, therefore, from that of nitrogen on the basis that the stopping powers are proportional to the atomic numbers.<sup>5</sup>

It will be noted that the ionization potential of argon lies between that of nitrogen and oxygen, hence the possibility exists for an  $A^+$  ion to transfer its charge to oxygen by collision of the second kind, i.e.,  $A^+ + O_2 = A + O^+$ . This possibility does not exist with nitrogen. Argon, therefore, when added to a nitrogen-oxygen mixture will markedly decrease the ratio of  $N^+$  to  $O^+$ . The decrease in  $N^+$  ion production corresponds to the decrease in the observed rate of synthesis.

The absence of any effect of added helium on the rate of reaction is doubtless due to the fact that a transfer of energy by collision of the second kind<sup>6</sup> takes place readily between  $He^+$  ions and nitrogen, according to the equation  $He^+ + N_2 = He + ^2N^+$ , forming in this case the 24 volt ion. On the other,

<sup>4</sup> Hughes and Klein: Phys. Rev., (2) 23, 450 (1924); Compton and van Voorhis: 27, 724 (1926).

<sup>5</sup> Found and Dushman: Phys. Rev., (2), 23, 734 (1924).

<sup>6</sup> Harnwell: Phys. Rev. (2), 29, 830 (1927).

hand, the ionization potential of helium is some 10 volts above that of oxygen so the probability of transfer of charge from helium to oxygen is very small. Helium, therefore, will tend to keep the  $N^+_{2}$  production up, while the  $O^+_{2}$  ion production will be decreased. The zero effect of helium on the rate is, therefore, a direct indication that the reaction is initiated entirely by  $N^+_{2}$  ions.

The maximum rate of synthesis being obtained at a 60% nitrogen content for nitrogen dioxide, and 33% for ammonia is readily explained by two facts: First, that less oxygen than hydrogen is needed by the  $N^+_{2}$  ion to complete the reaction, and second, that an ion attaches far more readily to oxygen than to hydrogen.

#### Suggestions regarding the Mechanism

Before attempting to present a mechanism for the reaction, a quantitative analysis of the yield from a nitrogen-oxygen mixture will be considered. It has been stated that a maximum of about 1.0 molecule of  $NO_2$  was obtained in the negative glow for each electron flowing in the outer circuit. While this value can be obtained with a fair degree of accuracy, the yield per  $N^+_{2}$  ion formed in the discharge involves an uncertainty of about four fold, since the actual number of  $N^+_{2}$  ions formed per electron flowing in the outer circuit can not be calculated with exactness. The factors determining the number of  $N^+_{2}$  ions produced are the relative stopping powers of oxygen and nitrogen, the average speed of the electrons entering the negative glow, and the relative amounts of current carried by the positive and negative ions.

In assigning an average speed to the electrons leaving the Crookes dark space, it is assumed that this speed is near that of the optimum ionizing potential for the gases, about 100 volts. Thus, one electron is considered as yielding about two positive ions in the negative glow.<sup>7</sup>

Since the stopping powers for nitrogen and oxygen are very nearly equal, the ratio of  $N^+_{2}$  to  $O^+_{2}$  ions in an  $N_2$ - $O_2$  mixture is about 1:1. Hence, if all the current in the discharge is carried by electrons, one  $N^+_{2}$  ion should result for each electron in the outer circuit.

On the other hand, if but half the current at the cathode is carried by electrons, as is indicated by the results of Aston,<sup>8</sup> then the number of electrons entering the negative glow is reduced by one-half and the total number of positive ions formed is correspondingly reduced. With one-half the current carried by positive ions, the number of  $N^+_{2}$  ions actually available for the reaction becomes one-fourth ion per electron in the outer circuit. This value represents a lower limit for the available  $N^+_{2}$  ions. The actual value is doubtless materially higher than this, since it is generally conceded that the positive ion current, while appreciable, is considerably less than half the entire current flowing in the discharge.

<sup>7</sup> Langmuir and Jones: *Phys. Rev.*, (2) 31, 357 (1928).

<sup>8</sup> Aston: *Proc. Roy. Soc.*, 96, 200 (1919).

While it is possible to suggest a large number of mechanisms by which  $N^+$  ions may combine with oxygen to form nitrogen dioxide, only two of the more probable types will be considered here.

**Mechanism 1.**

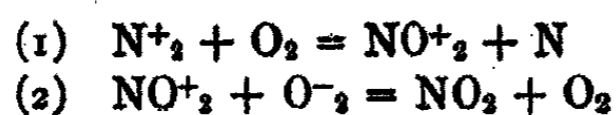

The final neutralization may take place upon collision with either  $O^-$  ions or electrons. A mechanism of this type yields one  $NO_2$  molecule per  $N^+$  ion.

**Mechanism 2.**

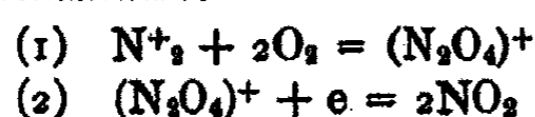

Neutralization of the  $(N_2O_4)^+$  ion cluster may again take place either by collision with an electron or an  $O^-$  ion. The yield obtained is two  $NO_2$  molecules per  $N^+$  ion.

The uncertainty involved in determining the exact number of  $N^+$  ions formed per electron in the outer circuit, makes it difficult to distinguish between the two types of mechanisms illustrated. However, by making certain assumptions, which appear to most accurately represent the rate of  $N^+$  formation in the discharge, a yield of two molecules of  $NO_2$  per  $N^+$  ion is obtained. These assumptions are that the positive ion current is small compared to the electron current, and that two positive ions are produced per electron entering the negative glow. The rates of production of  $N^+$  ions for different nitrogen-oxygen mixtures, as computed from the relative stopping powers of oxygen and nitrogen on the basis of the above assumptions, give for the rates of  $NO_2$  synthesis a yield illustrated by line B of Fig. 3, provided two molecules of  $NO_2$  are produced per  $N^+$  ion.

The computed curve B exactly coincides with the observed curve A over the region where the ratio of  $N^+$  ions to oxygen molecules is small. This indicates that two molecules of  $NO_2$  are formed for every  $N^+$  ion produced in gas mixtures containing more than 80% oxygen. Naturally such a yield can be expected only when the production of  $N^+$  ions is low. As the partial pressure of nitrogen is increased above 20%, the loss of  $N^+$  ions, by discharging on the walls and electrodes, and by premature gas phase neutralization, becomes appreciable. The difference between corresponding points on lines B and A represents the equivalent number of  $N^+$  ions lost to the system, at any given mixture ratio, by processes other than combination with oxygen to form nitrogen dioxide. This loss, while comparatively small for an  $N_2$ - $O_2$  mixture, is of necessity 100% for pure nitrogen.

In conclusion, therefore, it may be stated that, although the evidence is insufficient to settle the questions involved in the complete reaction mechanism, the most logical interpretation of the foregoing data indicates a yield of two  $NO_2$  molecules for each  $N^+$  ion entering the reaction, which is in accord with the second type of mechanism illustrated.

### Summary

The synthesis of nitrogen dioxide in the glow discharge is discussed.

The results presented are similar to those obtained previously for the synthesis of ammonia, since the reaction in both cases is initiated by  $N^+$  ions.

A yield of approximately one  $NO_2$  molecule per electron flowing in the outer circuit is obtained.

Some suggestions regarding the reaction between  $N^+$  ions and oxygen are presented but are necessarily incomplete due to the uncertainties in the exact number of  $N^+$  ions formed. The data indicate a maximum M/N ratio of two  $NO_2$  molecules per  $N^+$  ion.

## BERYLLIUM SALICYLATE

BY F. E. JONES, W. E. HAMER, C. W. DAVIES, AND C. R. BURY

During work on some complex salicylates a compound of the formula  $\text{BeC}_7\text{H}_4\text{O}_3 \cdot 2\text{H}_2\text{O}$  was prepared. This compound does not appear to have been described before, and we have therefore investigated some of its properties.

### Experimental

The compound was prepared by dissolving beryllium oxide in boiling water containing slight excess of salicylic acid. On cooling, it crystallised out slowly, but almost completely: it was washed with alcohol to remove excess acid and recrystallised from water. The pure compound was colorless, but traces of iron impart a yellow colour to the impure salt.

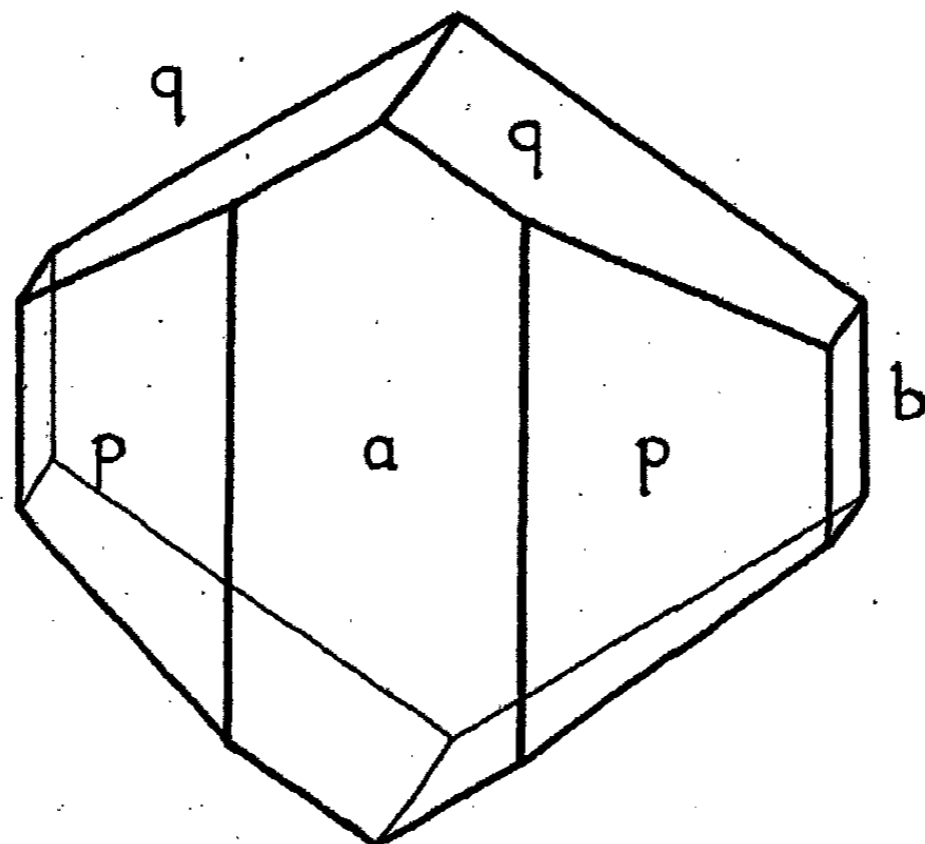

FIG. 1

Analysis.	Be (by ignition to BeO)	4.96, 4.99%
	C (by combustion)	45.9, 46.6%
	H (by combustion)	4.42, 4.41%

calculated for  $\text{BeC}_7\text{H}_4\text{O}_3 \cdot 2\text{H}_2\text{O}$  Be 4.98%, C 46.4%, and H 4.45%. Water was not driven off at  $100^\circ\text{C}$ : at somewhat higher temperatures the compound decomposed completely.

The density of the salt at  $25^\circ\text{C}$ ., referred to water at  $4^\circ\text{C}$ ., is 1.534, and its crystals are of the monoclinic hemihedral class.

$$a : b : c :: 0.7409 : 1 : 0.5828. \beta = 107^\circ 17'.$$

The predominant forms are  $a$  (100),  $a'$  ( $\bar{1}$  00),  $b$  (010),  $p$  (110),  $q$  (011), and  $q'$  (01  $\bar{1}$ ). The following forms have also been observed: (11  $\bar{1}$ ), (10  $\bar{1}$ ), and (21  $\bar{1}$ ).

	observed	calculated
$a$ (100) — $p$ (110)	35° 16'	—
$a$ (100) — $q$ (011)	74° 57'	—
$b$ (010) — $q$ (011)	60° 54'	—
$p$ (110) — $q$ (011)	60° 27'	60° 29'
$p$ (110) — $q'$ (01 $\bar{1}$ )	86° 1'	86° 2'
$p$ (110) — (10 $\bar{1}$ )	68° 10'	68° 7'
$a$ (100) — (11 $\bar{1}$ )	66° 7'	66° 6'
$a$ (100) — (21 $\bar{1}$ )	40° 54'	40° 52'

The solubility of the salt in water is:—

0.0256 mols per 1000 grs. water	at 17.92°C.
0.0311	26.15
0.0380	35.00

Each of these figures is the mean of two closely agreeing determinations, in one of which the solid was shaken with water, in the other with supersaturated solution. Solutions were analysed by evaporating to dryness in platinum dishes, igniting, and weighing as beryllium oxide.

#### Conductivity Measurements.

The usual Kohlrausch method was used. The bridge wire consisted of a straight manganin wire one metre in length connected to extension pieces of smaller cross-section which brought the effective length of the bridge up to seven metres. This was calibrated, using both direct and alternating current, against the standard resistance box. Of the other two arms of the bridge one consisted of the conductivity cell, to be described later, together with its leads, the resistances of which were measured and allowed for in the calculations; the other contained a resistance box calibrated at the National Physical Laboratory and, in parallel with this, a variable air condenser. In making a measurement several readings were taken, the point of balance, adjusted so as to lie near the centre of the wire, being taken for various values of the known resistance. A small induction coil was used as source of current and a sensitive telephone as detector.

Conductivity water for the experiments was prepared in a slightly modified form of the still described by Bourdillon.<sup>1</sup>

The conductivity cell was of the type described by Hartley and Barrett;<sup>2</sup> the cap and electrode supports were of borosilicate glass but the cell itself was of silica. It was supported in a thermostat maintained at  $25.00^\circ \pm 0.02$ . The temperature of the room was kept as constant as possible at  $18.5^\circ$ , the temperature at which the resistance box and bridge had been calibrated.

<sup>1</sup> J. Chem. Soc., 103, 791 (1913).

<sup>2</sup> J. Chem. Soc., 103, 786 (1913).



Liquid was introduced into the cell and maintained in it in an atmosphere of air purified by successive treatment with concentrated sodium hydroxide, Nessler's solution and concentrated sulphuric acid.

The cell constant was determined by making several measurements with dilute (below 0.002N) potassium chloride solutions of known concentrations and comparing these with the true conductivity values<sup>1</sup> of KCl at 25°. The KCl used for these determinations was obtained by recrystallising Kahlbaum's "100.00% pure" KCl from conductivity water and heating the product to incipient fusion in a platinum crucible.

TABLE I

C	$\sqrt{C}$	$\kappa_{\text{soln.}}$ $\times 10^6$	$\kappa_{\text{H}_2\text{O}}$ $\times 10^6$	$\kappa_{\text{corr.}}$ $\times 10^6$	$\Lambda$
Series A					
0.0004149	.02027	3.485	0.347	3.138	7.56
0.0007077	.02662	4.956	0.347	4.609	6.51
0.002026	.04501	10.633	0.347	10.29	5.08
0.003720	.06099	17.156	0.347	16.81	4.52
Series B					
0.004943	.07030	22.73	2.22	20.51	4.15
0.008534	.09238	34.86	2.08	32.78	3.84
0.01499	.1224	55.91	1.90	54.01	3.60
0.02922	.1710	99.23	1.54	97.69	3.34
0.05356	.2314	170.70	0.99	169.71	3.17
Series C					
0.004481	.06694	20.20	0.56	19.64	4.38
0.007531	.08678	31.10	0.53	30.57	4.06
0.01426	.1194	53.48	0.52	52.96	3.72
0.02729	.1652	94.70	0.52	94.18	3.45
0.04635	.2153	151.80	0.48	151.32	3.27

The conductivity results for beryllium salicylate are given in Table I. The procedure adopted with the most dilute solutions (series A) was to charge the cell with a known weight of conductivity water and measure its resistance; and then to add successive small quantities of an almost saturated solution of beryllium salicylate from a weight pipette, the resistance of the solution being measured after temperature equilibrium had been established. This method is of limited applicability owing to the low solubility of beryllium salicylate, and the measurements on the more concentrated solutions (series B and C) had therefore to be made singly, suitable amounts of conductivity water and of the beryllium salicylate solution being weighed out into the cell. The first column of Table I shows the equivalent concentration of the solutions and the second the square root of the concentration; the third gives the specific conductivity of the solution, the fourth the conductivity of the solvent and the fifth, obtained by subtracting the figures in the fourth col-

<sup>1</sup> Cf. Grindley and Davies: Trans. Faraday Soc., 25, 133 (1929).

umn from those in the third, gives the specific conductivity of the beryllium salicylate. The last column shows the equivalent conductivity.

The figures for the solvent's conductivity given in the fourth columns of the tables were, for series A, obtained by direct measurement with the pure solvent; but for series B and C, in which conductivity water and beryllium salicylate solution were mixed in the cell, it was assumed that carbon dioxide was the only impurity present and a calculation was made involving the concentration of carbonic acid in both before mixing, and the proportions

TABLE II

C.	E.M.F.	T.	P <sub>H</sub> .
0.05137	0.5552	16°C	4.68
0.01712	0.5782	16	5.08
0.05137	0.5562	18	4.67
0.05137	0.5568	18	4.68
0.03425	0.5643	18	4.81
0.01142	0.5861	17	5.21
0.00761	0.5901	17	5.28
0.00411	0.5938	17	5.34
0.00137	0.622	17	5.83

of the two taken; for this the data given by Kendall<sup>1</sup> were used. For series B the results of this calculation are untrustworthy as the mixing of the water and beryllium salicylate solution was carried out in contact with the air of the laboratory and the exact carbon dioxide content of the mixture was uncertain.

A further uncertainty in the solvent correction is caused by the extensive hydrolysis of beryllium salicylate; the solution is acid, as will be shown later, and a result of this will be to reduce the ionisation of the carbonic acid present. The results quoted above must therefore be regarded as overcorrected; that is, the equivalent conductivity values given are too low. This applies particularly to series B, where solvent of high carbon dioxide content was used, and to the most dilute solutions of series A where, again, the solvent's conductivity becomes a large percentage of the whole. Lack of complete concordance between the three series is attributed to this.

#### *P<sub>H</sub> determinations.*

The concentrations of hydrogen ions in a series of solutions containing varying concentrations of beryllium salicylate have been calculated from measurements of the E.M.F. of cells of the type:—

H<sub>2</sub>(Pt), Beryllium salicylate solution, KCl (M), HgCl, Hg. The P<sub>H</sub> was calculated from the formula:—

$$P_H = \frac{\text{observed E.M.F.} - \text{E.M.F. normal calomel electrode}}{0.00019837 T}$$

<sup>1</sup> J. Am. Chem. Soc., 38, 2460 (1916); 39, (1917).

The E.M.F. of the normal hydrogen electrode<sup>1</sup> being taken as 0.2848. The results obtained are given in Table II, where C is the concentration of beryllium salicylate in equivalents per litre.

#### Discussion

Beryllium salicylate resembles two similar compounds of beryllium with dibasic organic acids—the oxalate and the malonate<sup>2</sup>—in that its conductivity is very small and only changes very slowly with concentration. The con-

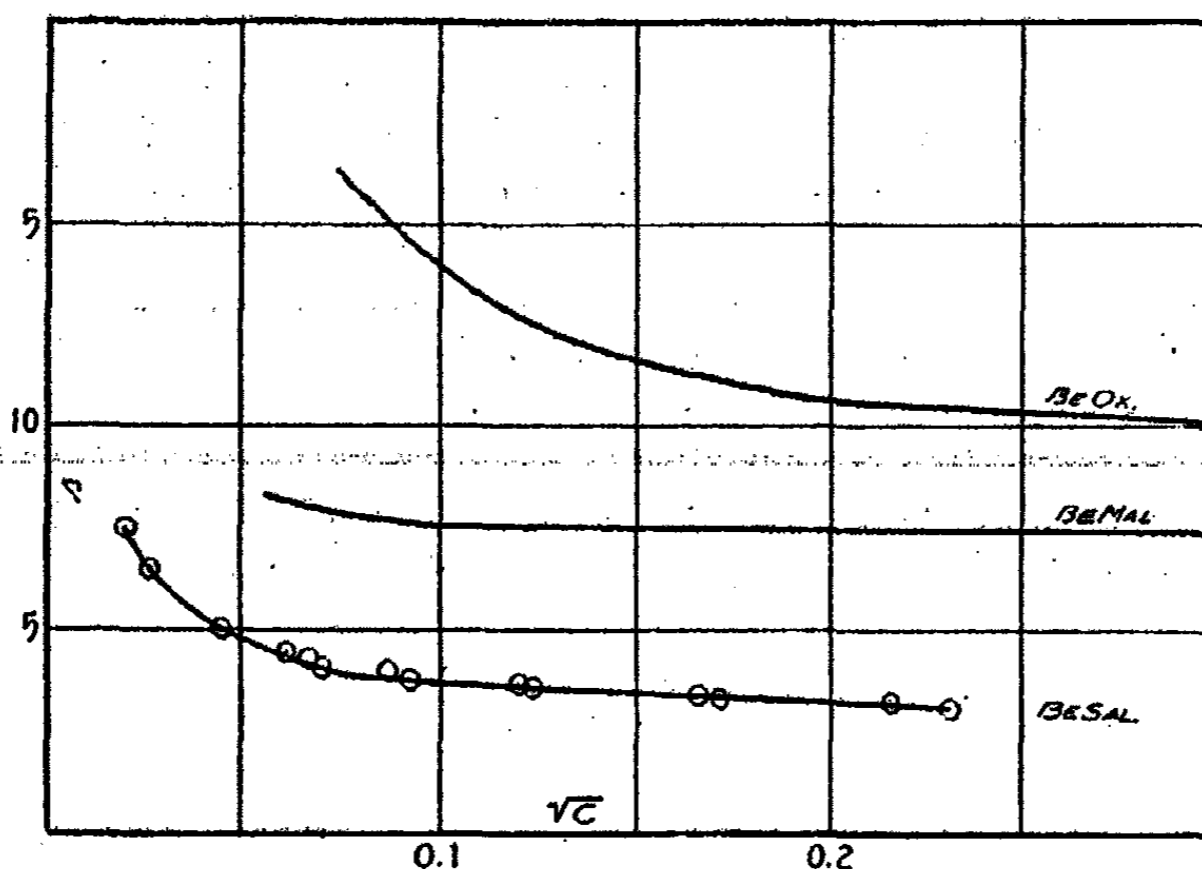
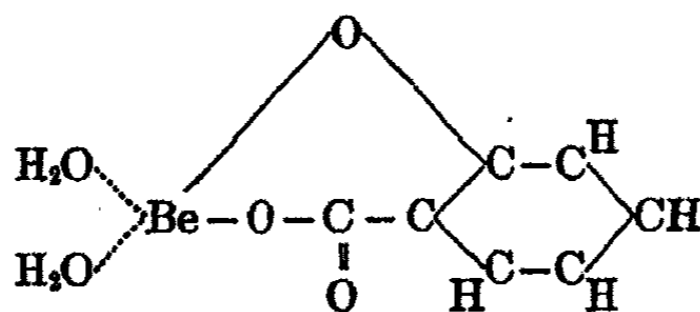

FIG. 2

ductivities of the three compounds are compared graphically in Fig. 2, in which equivalent conductivities are plotted against the square roots of the concentrations.

To explain the low conductivity, Sidgwick and Lewis have suggested that the two compounds investigated by them are mainly present in solution as neutral unionised complex compounds. In the case of the salicylate, a similar neutral complex is also probable, which may be represented by an analogous structure:—



Such a formula is in agreement with the known behaviour, in complex formation, of the beryllium and salicylate ions: it would account for the tenacity

<sup>1</sup> Clark: "Determination of Hydrogen Ions," pp. 161, 456 (1923).

<sup>2</sup> Sidgwick and Lewis: J. Chem. Soc., 129, 1287, 2538 (1926).

with which the water molecules are held, and would explain the low conductivities of its solutions.

To explain the form of the conductivity-concentration curve, Sidgwick and Lewis suggest the formation of a complex anion, a reaction which, in the case of the salicylate, can be represented by the equation:—

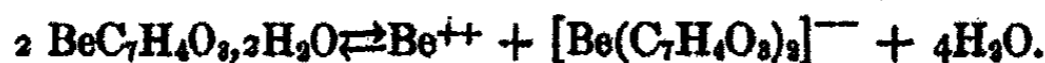

Such an equation demands that ionisation should, as a first approximation, be independent of concentration, as is found experimentally. These suggestions are supported by measurements of the freezing point of beryllium oxalate solutions. Unfortunately measurement of the freezing points of beryllium salicylate solutions are impracticable owing to its low solubility.

We think that certain well-known characteristics of beryllium cannot be neglected, and may even explain the conductivities and freezing points without the assumption of complex anion formation. The first characteristic is the weakness of beryllium hydroxide as a base; all salts of beryllium are appreciably hydrolysed in solution, and even the salt of such a weak acid as salicylic acid has an acid reaction. Secondly, beryllium oxide and beryllium ions have a great tendency to unite to form complex cations, as is shown by the fact that most beryllium salts dissolve large quantities of beryllium oxide.<sup>1</sup> The existence of such compounds as basic beryllium acetate, the structure of which has been established by Morgan and Bragg<sup>2</sup> is further proof of this tendency.

In an aqueous solution of any beryllium salt ( $\text{BeX}_2$ ) the following series of equilibria must therefore occur:—

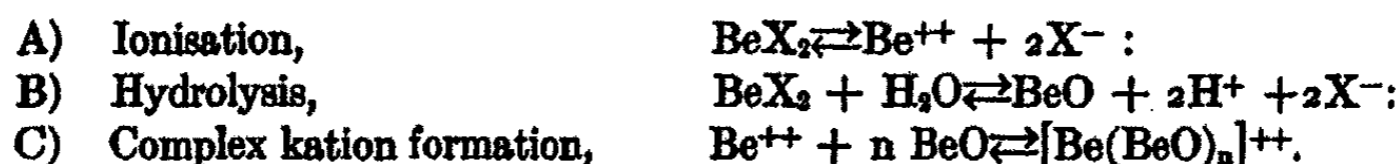

In the case of the oxalate, malonate, and salicylate, the following peculiarities have to be taken into consideration. Firstly, the unionised molecule (neutral complex) is peculiarly stable, and most of the beryllium will remain in this form. Secondly, the acids are weak dibasic organic acids: weakness of the acid favours hydrolysis rather than ionisation and as a result the ratio  $\text{BeO}/\text{Be}^{++}$  will be large and the number of beryllium oxide molecules in the complex cation ( $n$  in equation (C)) will be relatively large. Also, since the solutions are acid as the result of hydrolysis, and the second dissociation constants of the acids are small,<sup>3</sup> doubly charged acid anions will only be present in negligible amounts.

<sup>1</sup> Sidgwick and Lewis: *loc. cit.*

<sup>2</sup> *Proc. Roy. Soc.*, 104A, 437 (1923).

<sup>3</sup> For the second dissociation constant of salicylic acid Senter and Bulle (*J. Chem. Soc.*, 101, 2528 (1912)) found the value  $1 \times 10^{-12}$  at 19.6°C. by hydrolysis of ethyl acetate: Kolthoff (*Rev. Trav. Chim.*, 42, 969, 1923).  $0.36 \times 10^{-12}$  at 19°C. by the use of indicators: by E.M.F. measurements with the hydrogen electrode we find  $2.9 \times 10^{-12}$  at 25°C., and  $0.84 \times 10^{-12}$  for the first dissociation constant.

If  $H_2Y$  represents a weak dibasic acid, equations (A) and (B) become:—

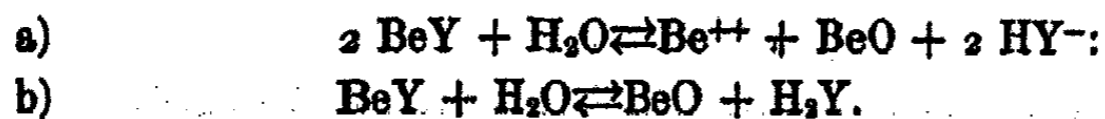

Combination of these with equation (C) yields an equation which will represent the behavior of these substances in solution:—



From this equation it is obvious that ionisation should only increase very slowly on dilution and could hardly be detected by freezing point measurements. Slight ionisation of the acid ( $H_2Y$ ) is sufficient to account for the observed acidity.

The authors wish to express their thanks to the Chemical Society for a grant towards the cost of the conductivity apparatus used in this work; and one, (F.E.J.), to the Senate of this College for the award of a Garrod Thomas fellowship.

#### Summary

Beryllium salicylate dihydrate is described: its crystallographic form, density, solubility in water, and the electrical conductivity and  $P_H$  of its aqueous solutions have been measured.

A structure for this compound is suggested, and the behavior of beryllium salts in aqueous solution is discussed.

*Edward Davies Chemical Laboratories,  
University College of Wales,  
Aberystwyth, Wales.  
August 13, 1929.*

## AN ELECTROMETRIC STUDY OF THE PRECIPITATION OF COPPER IONS BY ALKALIES

BY ARTHUR JOHN HOPKINS AND RALPH ALONZO BEEBE

### A. The Sulphate

That the literature is filled with conflicting data concerning the composition of the basic sulphates of copper is indicated by the references cited in the recent papers on the subject. To avoid repetition of this list of references, the reader is referred to a paper by Nelson.<sup>1</sup>

Several investigators have attempted to determine by direct analysis the composition of the precipitate formed by addition of various proportions of alkali to copper sulphate solutions. Fowles<sup>2</sup> has suggested that the method of precipitation by alkali is open to the objection that the precipitate may be contaminated by alkali sulphate, referring to Brunner.<sup>3</sup> Such contamination, if it occurs, would of course affect the ratio  $\text{Cu} : \text{SO}_4$  as determined by analysis. The electrometric method, however, is not open to this objection since the number of hydroxyl ions needed to complete the precipitation would not be affected by this contamination.

Since in the presence of copper ions it was impossible to use a hydrogen electrode for determining the pH values throughout the titrations, the quinhydrone electrode was used. This was connected with a saturated calomel reference electrode. Our data was drawn from values below a pH of 8 since the quinhydrone electrode is not dependable at points much above this figure, but the curves are extended for completeness to a pH of 9 or a little higher. Even at this pH value, they are not far in error.<sup>4</sup>

Other electrometric studies of the precipitation of copper ions by alkalies have been recorded. Müller and Müller<sup>5</sup> have used the quinhydrone electrometric titration by alkali solutions as a method for quantitative estimation of free acid in the presence of metal ions. Their interest lay however in the titration of the free acid and not of the metal ions involved. Therefore they made no detailed study of the precipitation of the latter. Britton<sup>6</sup> has used the oxygen electrode for the study of the precipitation of copper and other

<sup>1</sup> J. Phys. Chem., 32, 1185 (1928).

<sup>2</sup> J. Chem. Soc., 1926, 1845.

<sup>3</sup> Pogg. Ann., 15, 476 (1829).

<sup>4</sup> The authors are aware that O'Sullivan (Trans. Faraday Soc., 21, 319 (1925)) has observed a slow drift of the E.M.F. of a quinhydrone electrode in a solution of copper sulphate. A study of his paper has satisfied us however that the error due to the mutual action of copper ions and quinhydrone is so small that it has little effect on the end-points of our titration curves. All of our titrations were completed within two hours after the addition of the quinhydrone, and many in shorter time. The E. M. F. drift, as described by O'Sullivan, is nearly negligible up to two hours.

<sup>5</sup> Z. anal. Chem., 73, 47 (1928).

<sup>6</sup> J. Chem. Soc., 1925, 2148.

ions by bases; but only one curve for one set of conditions is recorded. The same author<sup>1</sup> attempted to employ the copper electrode to measure the change in copper ion concentration while sodium hydroxide was added pro-

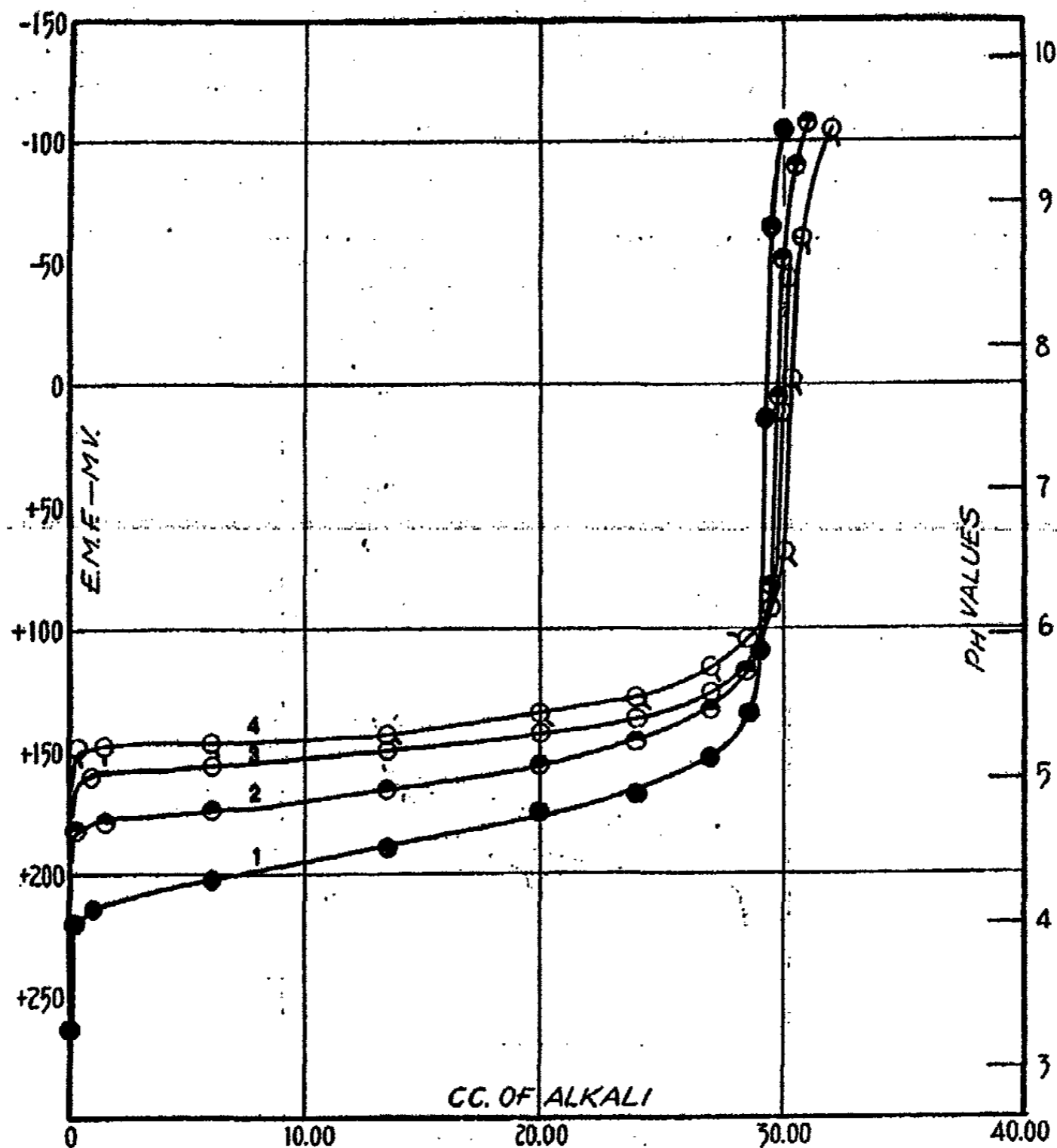

FIG. 1  
Copper sulphate with sodium hydroxide.  
(30.00 cc alkali = 1.5 moles per mole copper salt).

gressively to the solution but failed to get consistent behavior on the part of the electrodes.

Since the preparation of this paper, Fuoss<sup>2</sup> has reported the use of a copper-copper oxide electrode system for the above titration.

#### Results for the Sulphate

For all the titrations reported in this paper, samples measuring 40.00 cc. of tenth-normal solutions of copper salts were employed. These solutions

<sup>1</sup> J. Chem. Soc., 1925, 2796.

<sup>2</sup> Ind. Eng. Chem. Anal. Ed., 1, 128 (1929).

were either evaporated or diluted to such volume as would produce the final volumes recorded in the tables. All the points plotted on the charts represent E. M. F. readings taken after the addition, while stirring, of small increments of tenth-normal sodium hydroxide solution free from carbon dioxide.

Our first titration curves showed breaks after approximately 1.5 moles (30 cc.) of alkali had been added per mole of copper sulphate, indicating the precipitation of the 1:3 salt according to the equation:



The breaks were, however, slightly at variance from this mark. We therefore

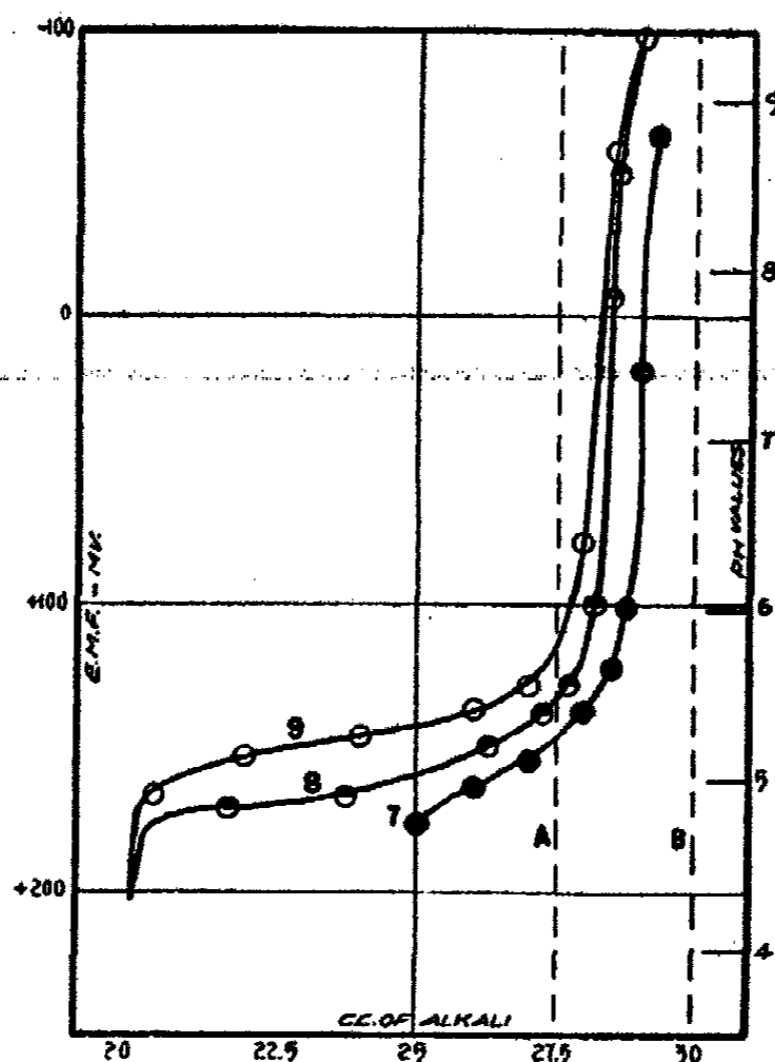

FIG. 2  
Copper sulphate with sodium hydroxide.

set out to study whether the position of the end-points was dependent on the conditions of precipitation. That such is the case is evident from the results recorded below.

*Effect of concentration.*

The effect of concentration of the solutions from which the copper ions were precipitated is shown by the data for samples 1 to 4. In Table I end-points are given, expressed in column 2 as cc. of tenth-normal alkali required to precipitate the 4 milligram equivalents of copper sulphate; and in column 3, as moles of alkali per mole of copper sulphate. For comparison with the results of those investigators who have studied the composition of the precipitate by analysis for the Cu to  $\text{SO}_4$  ratio, this ratio as calculated from our end-points is recorded in column 4. The curves are shown on Fig. 1.



*Effect of prolonged stirring.*

To each sample was added at first 29.00 cc. N/10 sodium hydroxide. In the next set of experiments, samples #5 and #6, each of final volume 400 cc. were compared as follows: sample #5 was titrated electrometrically without undue delay; while sample #6 was stirred over night before its titration was completed. The first required an addition of 1.05 cc. N/10 alkali, making a total of 30.05 cc. before the end-point was reached; the second, #6,—which was stirred—required 0.65 cc., a total of 29.65 cc. Therefore, 0.4 cc. less of the alkali was required after over-night stirring of the bulk of the precipitate in contact with the solution. End-points are given in Table I. These two curves are shown on Fig. 4, B.

*Effect of temperature.*

It was not practicable to employ the quinhydrone electrode at temperatures well above that of the room. Therefore two methods of procedure were

TABLE I  
Copper Sulphate

Sample	Condition	Final volume cc.	cc. alkali	Moles Na OH per Mole CuSO <sub>4</sub> used	Ratio Cu:SO <sub>4</sub> in ppt.
1	Titrated immediately	38	29.40	1.47	3.79
2	" "	85	29.75	1.49	3.92
3	" "	200	29.90	1.495	3.96
4	" "	400	30.10	1.505	4.04
5	29.00 cc. added; titration completed.	400	30.05	1.50	4.00
6	29.00 cc. added; stirred over night; titrated.	400	29.65	1.48	3.86
7	25.00 cc. added while boiling; cooled; titration completed.	33	28.95	1.45	3.62
8	20.00 cc. added cold; refluxed over night; cooled; titration completed.	70	28.44	1.42	3.46
9	20.00 cc. added cold; refluxed two days; cooled; titration completed.	70	28.15	1.41	3.38

devised to test the nature of the precipitate when subjected to higher temperatures. Sample #7 was evaporated to 4 cc. and gentle boiling was maintained while 25.00 cc. of sodium hydroxide was slowly added to it with stirring. This was then cooled to room temperature, quinhydrone added, and the titration completed electrometrically. This sample, #7, required 3.95 cc. more, or a total of 28.95 cc. of alkali, for completion of precipitation. By the second method, to each of two samples of copper sulphate solution, at room temperature, were added 20.00 cc. of sodium hydroxide. Each sample, containing the precipitated salt in presence of the copper sulphate remaining

in solution, was refluxed, in the case of sample #8 over night; in the case of sample #9, two days. When these samples had been cooled to room temperature, the end-points were reached by the addition of quinhydrone and sodium hydroxide. Sample #8 required a total of 28.44 cc. alkali and sample #9 a total of 28.15 cc. The data for samples #7, #8 and #9 are shown in Table I, and the graphs on Fig. 2.

#### Discussion.

Before presenting our conclusions with regard to the composition of the basic sulphate, mention should be made of the work of other recent investigators on the subject. Williamson<sup>1</sup> and Nelson,<sup>2</sup> using conditions most comparable to our own, have studied by analysis the composition of the precipitate formed for various ratios of sodium hydroxide to copper sulphate. Williamson concludes that as long as the molecular ratio of alkali to copper sulphate does not exceed 1.5 to 1, the composition of the precipitate is that of the 1:3 salt,  $\text{CuSO}_4 \cdot 3 \text{Cu}(\text{OH})_2 \cdot x\text{H}_2\text{O}$ ; and accounts for the discrepancy between his analytical ratio of 3.8 to 1 and a theoretical ratio of 4 to 1, on the basis of unfavorable conditions of experiment. Nelson, working at 5°C, however, concludes that the ratio of Cu to  $\text{SO}_4$  is a function of the molecular ratio of alkali added per mol of copper sulphate. Within the region 0.5 moles to 1.5 moles of alkali per mole of copper salt, he finds the copper to sulphate ratio<sup>3</sup> varying from 3.5:1 to 4:1.

Britton,<sup>4</sup> from a phase rule study of sulphuric acid and of copper sulphate on the moist precipitated basic salt concluded that the 1:3 salt is the only stable form. Fowles<sup>5</sup> is in disagreement with Britton. He found that the composition of the precipitate formed by the hydrolysis of copper sulphate is  $\text{CuSO}_4 \cdot 2\text{Cu}(\text{OH})_2$ . He also demonstrated that the approximately 1:3 salt could be quantitatively converted into the 1:2 salt by boiling in a strong solution of copper sulphate. Fowles suggests that under certain conditions, both the 1:2 and the 1:3 salts can be formed, but holds that the 1:2 salt is the only stable form.

It is obvious that calculations of composition of the precipitate can be made only at the end-points of the curves where it is assumed that all the copper and hydroxyl ions have been precipitated. This assumption is substantiated by Fuoss.<sup>6</sup> Interpretation of the form of the curves, however, throws further light on the subject. Our conclusions may be stated as follows:

<sup>1</sup> J. Phys. Chem., 27, 790 (1923).

<sup>2</sup> J. Phys. Chem., 32, 1185 (1928).

<sup>3</sup> Nelson's analyses beyond 1.5 moles of alkali are unnecessary because, from this point on, all the copper and hydroxyl ions, within the limits of analytical error, are precipitated. It is therefore possible to calculate the ratio of Cu to  $\text{SO}_4$  in the precipitate on the assumption that the addition of alkali beyond the 1.5 to 1 ratio results merely in the displacement of sulphate radical by hydroxyl. Our calculated values check the experimental values on Nelson's curve.

<sup>4</sup> J. Chem. Soc., 1925, 2796.

<sup>5</sup> J. Chem. Soc., 1926, 1845.

<sup>6</sup> Ind. Eng. Chem. Anal. Ed., 1, 128 (1929).

1. Since none of the curves shows more than one inflection indicating precipitation, this would seem to eliminate the possibility of formation of several basic salts under the conditions used.

2. The sharp inflection at pH7 obtained in all the curves is evidence for the formation of a definite compound and not a series of solid solutions.

3. In curves 1 to 6, precipitated at room temperature, the close approximation to 1.5 moles of alkali required per mole of copper sulphate indicates the preferential precipitation of the 1:3 salt. Even in these cases, it is noticeable that change in concentration and prolonged stirring have a measurable effect on the position of the end-point.

4. The tendency for the curves to break short of the 1.5 moles of alkali in the cases where the precipitate was heated in the presence of excess copper sulphate, curves 7, 8 and 9, would indicate the possible slow conversion of the 1:3 salt initially precipitated by the action of the copper sulphate in solution, into a salt of higher sulphate content,<sup>1</sup> probably the 1:2 salt reported by Fowles.

#### B. The Nitrate

The conditions of precipitation of samples #1 to #4 of copper nitrate are the same as those of samples #1 to #4 under the sulphate precipitation; and the results are to be compared with the latter, as showing the effect of concentrations.

Likewise with samples #5 and #6, #5 is a blank both in the sulphate and in the nitrate; and #6 shows in each case the effect of prolonged stirring.

It was impossible with the nitrate to obtain curves similar to those marked #7, #8 and #9 of the sulphate because of the decomposition of the precipitated salt on boiling, yielding black copper oxide.

##### *Effect of concentration.*

The final volumes, the cc. alkali used and the moles of alkali per mole of copper nitrate<sup>2</sup> are given in Table II. The corresponding curves are shown in Fig. 3. Each of the first four samples was stirred but only during the titration, as was the case with the sulphate.

The effect of concentration in the precipitation of copper ions from nitrate solutions is much greater than was true for the sulphate. For the most dilute solutions, over 38.00 cc. of alkali were required but only 30.15 cc. for the

<sup>1</sup> This conversion is most noticeable in curves 8 and 9. If we assume that the precipitate after refluxing had all been converted into the 1:2 salt, and that the excess copper sulphate was precipitated as the 1:3 salt when the titration was completed at room temperature, the expected alkali requirement is 27.50 cc. (20.00 cc. would convert 30.00 cc. of the sulphate into the 1:2 salt; the remaining 10.00 cc. of sulphate would require 7.50 cc. of alkali for its conversion to the 1:3 precipitate). The dotted vertical line A on Fig. 2 shows where the curves would break if the above assumptions were true. The vertical line B would be the position of the breaks if pure 1:3 salt were precipitated. In curve 9 with the break at 28.15 cc., we have indication that over two-thirds of the possible conversion to 1:2 salt has occurred.

<sup>2</sup> For some of the nitrate experiments, barium hydroxide (free from carbonic acid) was used as precipitant. Check determinations using sodium hydroxide, showed that the substitution made no difference.

most concentrated. If the copper were precipitated according to the equation,



the alkali would be 40 cc. We may assume, in explanation of the results of our experiments, that in the more dilute solutions there was precipitated a

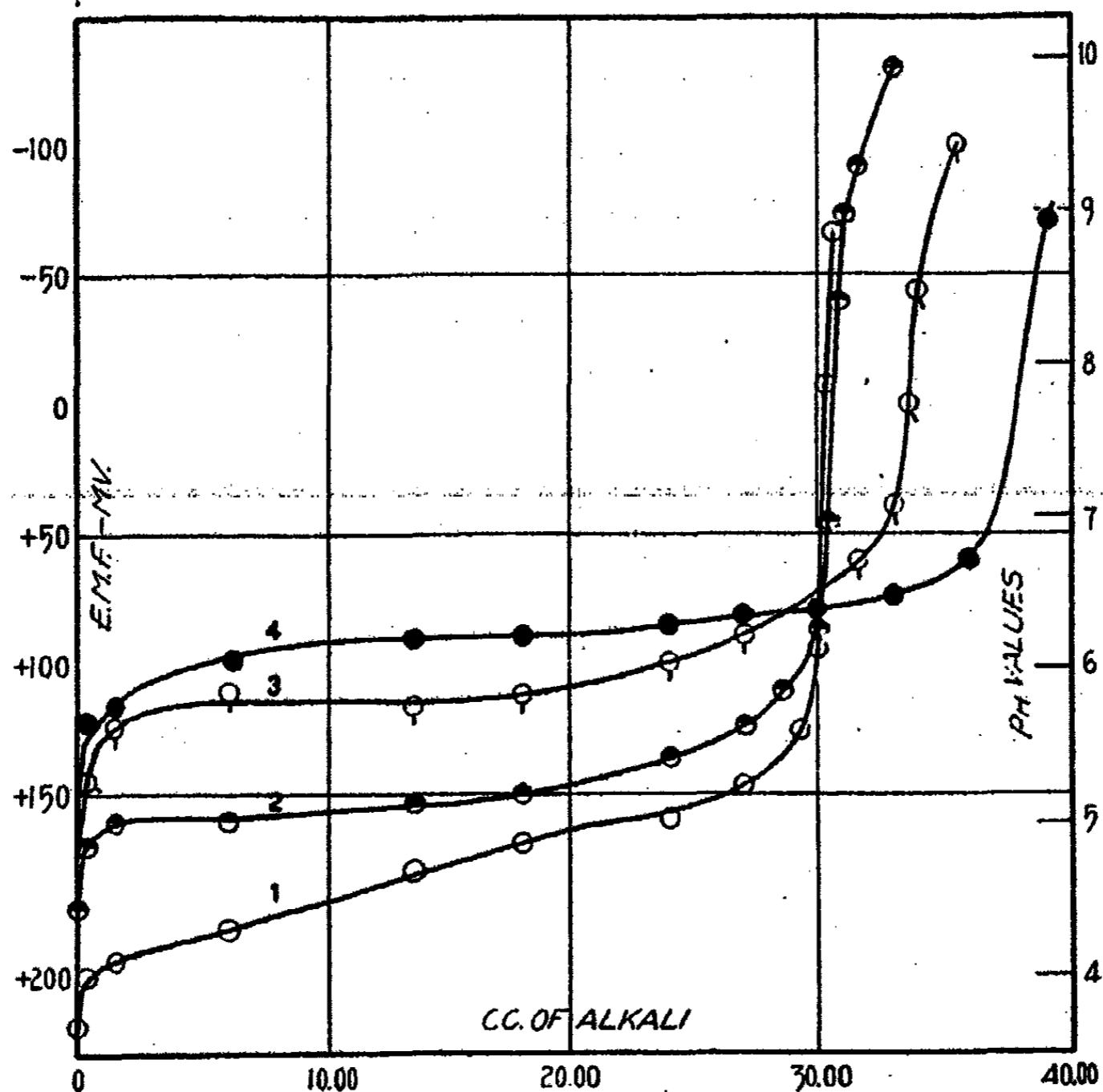

FIG. 3  
Copper nitrate with sodium hydroxide.

mixture of the base  $\text{Cu}(\text{OH})_2$  and the salt  $\text{Cu}(\text{NO}_3)_2 \cdot 3 \text{Cu}(\text{OH})_2 \cdot x\text{H}_2\text{O}$ ; while the precipitate formed at higher concentration was almost exclusively the 1:3 salt.

*Effect of prolonged stirring.*

To samples #5 and #6 of copper nitrate, the final volume being 400 cc., were added at first 30.00 cc. of tenth-normal alkali; then sample #5 was titrated to completion with very little delay but sample #6 was first subjected to stirring for four days, after which the titration was completed. The data are given in Table II and the curves are shown on Fig. 4a.

In the case of sample #5, the reaction goes nearly completely to form the hydroxide; but in the case of sample #6, the copper hydroxide, at first formed, probably reacted with the copper nitrate remaining in solution to form the

1:3 salt. Apparently, however, some of the hydroxide remained even after four days' stirring, since the total alkali used is still 0.75 cc. higher than required for the 1:3 salt.

### C. The Chloride

The volumes of alkali required to precipitate the copper from 40.00 cc. samples of tenth-normal chloride solutions, under varying conditions, were determined by the electrometric method.

TABLE II  
Copper Nitrate

Sample	Conditions	Final volume in cc.	cc. alkali added	Moles of alkali per mole $\text{CuSO}_4$
1	Immediate titration	25	30.15	1.51
2	" "	70	30.52	1.58
3	" "	200	32.55	1.68
4	" "	400	38.2	1.91
5	30.00 cc. alkali added; titration completed.	400	37.4	1.87
6	30.00 cc. alkali added. stirred four days; then titration completed.	400	30.75	1.58

No measurable effect is produced by change in concentration or by prolonged stirring. Typical results are given in Table III, samples 1, 5 and 6. Samples 5 and 6 are comparable to 5 and 6 in previous sections and these curves are presented in Fig. 4 C.

Sample 8 is to be compared with the same numbered sample in the sulphate list. A slight variation, not however so marked as in the case of the sulphate, seems to have been effected by refluxing over night.

TABLE III  
Copper Chloride

Sample	Conditions	Final volume cc.	cc. alkali	Moles of alkali per mole $\text{CuSO}_4$
1	Titrate immediately	35	30.23	1.51
5	Added 29 cc. alkali; completed titration immediately.	70	29.85	1.49
6	Added 29 cc. alkali; stirred 24 hours; completed titration.	400	30.15	1.51
7	Added 20 cc. alkali; refluxed over night; cooled and completed titration.	400	30.15	1.51

The amount of alkali required, as shown in Table III, corresponds, very closely to the requirement for the 1:3 salt,  $\text{CuCl}_2 \cdot 3 \text{Cu}(\text{OH})_2 \cdot x \text{H}_2\text{O}$ . This result is in accord with the conclusions of Britton whose phase rule study points to the stability of the 1:3 salt.

*Comparison of the three salts of copper.*

A comparison of our data for the three salts shows that the chloride end-points are least affected by alteration of conditions of precipitation, the sulphate next and the nitrate most of all. This is well illustrated by the effect of stirring, the curves for which are placed for comparison in Fig. 4. Curve 5, under each section, represents immediate titration; and curve 6, titration after prolonged stirring. Müller and Müller<sup>1</sup> propose to study this precipi-

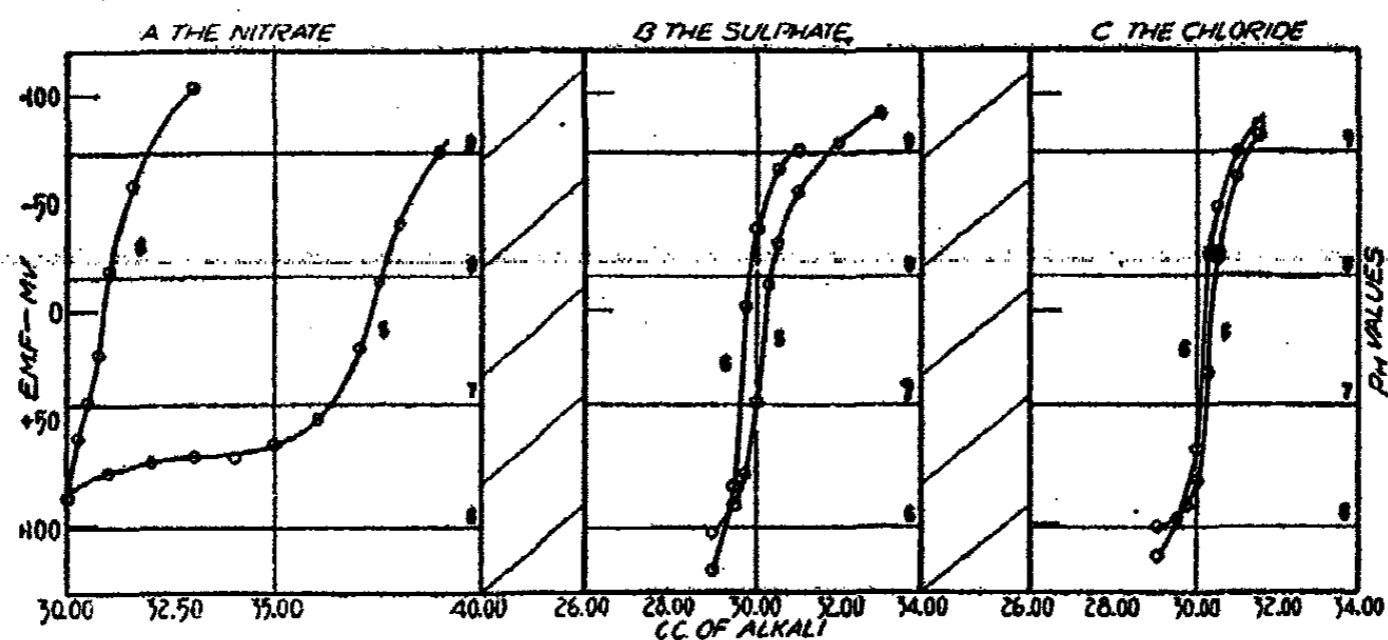

FIG. 4  
The effect of prolonged stirring.

tation of the 1:3 salt as a means of quantitative determination of copper. Our results would indicate the possibility of success, provided the copper were present in the form of the chloride. If in the form of the sulphate or nitrate, variations in the alkali requirement with difference in concentration and time of reaction would make such a procedure unreliable especially in the case of the latter salt.

#### Summary

Curves have been determined for the electrometric titration of copper sulphate, copper nitrate and copper chloride solutions with sodium hydroxide under varying conditions.

1. The Sulphate. (a) The single sharp inflection found in all sulphate curves indicates the precipitation of a definite basic salt.

(b). The amount of alkali required for complete precipitation of copper from a sulphate solution is however dependent on the conditions of precipitation.

(c). The precipitate has a composition corresponding, in some cases closely to the 1:3 salt,  $\text{CuSO}_4 \cdot 3 \text{Cu}(\text{OH})_2 \cdot x \text{H}_2\text{O}$ ; but in other cases, to a mixture of the 1:3 salt and a less basic salt.

<sup>1</sup> Z. anal. Chem., 73, 47 (1928).

2. **The Nitrate.** (a) The amount of alkali required for complete precipitation of copper from a nitrate solution is very greatly influenced by conditions of precipitation.

(b) Titrations indicate that the precipitate from nitrate solutions is a mixture of copper hydroxide,  $\text{Cu}(\text{OH})_2$ , and the 1:3 salt,  $\text{Cu}(\text{NO}_3)_2 \cdot 3\text{Cu}(\text{OH})_2 \cdot x\text{H}_2\text{O}$ .

3. **The Chloride.** The amount of alkali required for complete precipitation of copper from a chloride solution is nearly independent of the conditions studied; and the composition of the precipitate corresponds very closely to the requirement for the 1:3 salt,  $\text{CuCl}_2 \cdot 3\text{Cu}(\text{OH})_2 \cdot x\text{H}_2\text{O}$ .

THE INFLUENCE OF PHYSICAL STATE OF A SOAP SOLUTION  
UPON THE RATE OF SAPONIFICATION OF TRIGLYCERIDES  
AND THE DIFFERING DEGREES OF EMULSIFICATION  
FOR NEIGHBORING TRIGLYCERIDES

BY JAMES W. MCBAIN AND YASOTA KAWAKAMI

Introduction

In endeavoring to supply systematic information with regard to the rate of saponification of oils, fats, waxes and triglycerides when boiled with aqueous sodium hydroxide,<sup>1</sup> the first step was to develop a method by which each factor could be isolated and studied quantitatively. This was accomplished<sup>2</sup> by using the hydrogen electrode to follow the rate of disappearance of the alkali in the aqueous phase and by keeping all the materials in the system in such large concentrations relative to the alkali that the conditions remained constant throughout any one experiment. Each factor in turn can now be varied in successive experiments. It has been found that the nature of the oil, the nature of the soap, the physical state of the soap solution and the addition of salts have each a great effect upon the rate of reaction. The rate is in most cases proportional to the concentration of hydroxyl ion.

The most important factor has been found to be the degree of emulsification, which is very different for different oils. Hence in the present paper data are adduced for a series of pure triglycerides. These show a remarkable diversity of behavior between neighboring members of the same homologous series. It is customary in discussions of the theory of emulsions and emulsification to focus attention upon the emulsifying agent. It becomes evident that attention must also be given to the chemical individuality of the liquid emulsified.

The present communication further provides quantitative information with respect to the state of the soap solution whether homogeneous aqueous solution, transparent liquid crystal, or completely grained out opaque soap curd. Not only do these differ in emulsifying properties but even with any one of these single phases the rate depends upon the amount of NaCl present.

Apparatus and Material

The apparatus employed was the same as that used by McBain, Howes and Thorburn (*loc. cit.*) and by McBain, Humphreys and Kawakami (*loc. cit.*). A detailed description of the apparatus and a diagram of the set-up are given in the former paper.

<sup>1</sup> The only published experimental papers on this subject are: M. H. Norris and J. W. McBain: *J. Chem. Soc.*, 121, 1362 (1922); G. I. Finch and A. Karim: *J. Soc. Chem. Ind.*, 45, 35T, 72T (1926); J. W. McBain, H. S. Howes and M. Thorburn: *J. Phys. Chem.*, 31, 131 (1927); J. W. McBain, C. W. Humphreys and Y. Kawakami: *J. Chem. Soc.*, 1929, 2185.

The related subjects of fat-splitting, hydrolysis, and fermentation are well discussed by H. M. Langton (*J. Oil and Colour Chem. Ass.*, 5, 41 (1922)) with numerous references to that literature.

<sup>2</sup> J. W. McBain, H. S. Howes and M. Thorburn: *loc. cit.*



The standard sodium hydroxide solutions were prepared by dissolving Merck's C.P., analyzed sodium hydroxide in freshly boiled out distilled water. Before dissolving, the surface of the sticks was always washed off with distilled water. Of course, there were probably small amounts of carbonate remaining, but comparison with the other experiments in which sodium drippings were employed in preparing the hydroxide solutions showed that the small amounts of carbonate present as impurities had no appreciable effect upon the rate of saponification. The coconut oil (Philippine Islands) was obtained from Curtis and Tompkins, San Francisco, and was identical with coconut oil No. 1 used in the preceding paper by McBain, Humphreys and Kawakami, which has been shown to give the same rate constants as the coconut oil used in the earlier paper by McBain, Howes and Thorburn. The coconut oil was neutralized with dilute sodium hydroxide before using. The sodium chloride, sodium palmitate, and the pure triglycerides, trilaurin, trimyristin, tripalmitin, tristearin, triolein, tricaprylin and tributyrin were supplied by Kahlbaum except where otherwise mentioned. The two samples of specially made sodium palmitate used contained 6.0 and 2.65 per cent water, respectively. The  $\alpha$ -monopalmitin and  $\alpha\alpha$ -dipalmitin were supplied through the kindness of Dr. Bergstrom who prepared them from Kahlbaum's potassium palmitate and the corresponding chlorhydrins. The  $\alpha$ -monopalmitin was recrystallized from ethyl alcohol, butyl alcohol, ethyl alcohol again and lastly from benzol. The soap employed as a constant emulsifying agent in the studies of the rate of saponification of pure triglycerides was a potassium coconut oil soap obtained through the courtesy of the Davies-Young Soap Co., Dayton, Ohio. They stated that only Cochin coconut oil, potassium hydroxide, and distilled water were used in making it. It contained 62.5 per cent anhydrous soap.

#### Procedure

The actual procedure followed in the first series of experiments was the same as that of McBain, Howes and Thorburn (*loc. cit.*), but the following changes were made in the procedure for the other experiments where sodium chloride was added to the soap and oil at the beginning of the reaction. Nine tenths of the required water was added with the sodium chloride and one tenth with the sodium hydroxide. The hydrogen electrode was immersed in the reaction mixture before the standard alkali solution was added in order to prevent "poisoning" by a solid coating of soap.

#### Calculation of Results

The rate constant  $K$  is found as the slope of the straight line obtained by plotting the observed E.M.F. in millivolts against the time and applying the necessary correction for the reverse reaction which takes place. A detailed account of the method of calculation is given in the paper by McBain, Howes and Thorburn (*loc. cit.*). 0.910 volts was taken as the nearest constant value of the E.M.F. corresponding to equilibrium, and, in drawing the straight line to obtain the rate constant, the observed values at the very beginning of

TABLE I

The rate of saponification of various pure triglycerides under precisely similar conditions, using 1 N<sub>w</sub> solution of the potassium soap of coconut oil as emulsifier.

Oil	Melting Point	Initial Conc. N <sub>w</sub>	Rate Constant K	Mean K	Emulsification
Tributylin*	————	1.0	200-300	(250)	Dissolved
Tricaprylin	————	1.0	31.0	31.0	Nearly complete
α-monopalmitin	65.0	0.82	29.9	29.9	Complete
α-dipalmitin	69.0	1.0	26.0	26.0	Complete
Tripalmitin* <sup>1</sup>	64.5-64.8	1.0	{ 22.0 22.0 20.0	21.33	Complete
Tripalmitin* <sup>2</sup>	65.0-65.5	1.0	17.2	17.2	Complete
Tripalmitin* <sup>3</sup>	59.0-59.5	1.0	(9.5)	(9.5)	Imperfect
Tristearin* <sup>4</sup>	69.5-70.0	0.808	{ 5.8 6.3	6.05	Incomplete
Tristearin	69.5-70.0	1.0	{ 5.7 6.3	6.00	Incomplete
Trilaurin* <sup>4</sup>	46.0-46.2	1.13	{ 3.30 4.22 3.65	3.72	
Trimyristin	54.8-55.0	1.0	{ 2.25 2.23 3.0	2.49	Two layers
Trimyristin* <sup>5</sup>	54.8-55.0	1.0	{ 0.82 0.82	0.82	Two layers
Triolein* <sup>6</sup>	————	1.0	0.79-1.20	(1.0)	Two liquid layers
Triolein* <sup>7</sup>	————	0.45	(1.33)	(1.33)	Two liquid layers
Triolein* <sup>8</sup>	————	1.0	0.54	0.54	Two liquid layers
Triolein* <sup>9</sup>	————	1.0	0.43	0.43	Two liquid layers

\* Acid value 0.972; used as obtained.

<sup>1</sup> Used as obtained. The reaction mixture cooled after use to room temperature.

<sup>2</sup> Twice extracted with absolute alcohol. Remained as a permanent emulsion.

<sup>3</sup> Obtained from Eimer and Amend, New York. The sample was impure and very acid and was twice treated with dilute alkali.

<sup>4</sup> Data obtained by Mr. Humphreys. The standard NaOH solutions were prepared by dissolving sodium drippings in freshly boiled out distilled water.

<sup>5</sup> Obtained from Eastman Kodak Co. and seemed less pure than the Kahlbaum sample as was indicated by the brownish color.

<sup>6</sup> Treated with absolute alcohol twice.

<sup>7</sup> Less pure than sample<sup>6</sup>. Obtained from residue for preparing sample<sup>6</sup> by treating with absolute alcohol, evaporating, treating with alcohol again and separating.

<sup>8</sup> Recovered from sample<sup>6</sup> reaction mixture by extraction with ether after the reaction was over.

<sup>9</sup> Treated with absolute alcohol five times.

the reaction and those lower than 0.950 volts, at which about 95 per cent of the reaction had been completed, were not taken into consideration. 593

### Part I

#### *Results For Rate of Saponification of Homologous Series of Pure Triglycerides.*

The influence of minute change in chemical constitution upon the rate of saponification of pure triglycerides was observed in the first series of experiments. Approximately 1 N<sub>w</sub> trilaurin, trimyristin, tristearin, triolein, tripalmitin, tributyrin, tricaprylin,  $\alpha$ -monopalmitin and  $\alpha\alpha$ -dipalmitin were saponified successively with 1 N<sub>w</sub> potassium coconut oil soap and 0.1 N<sub>w</sub> sodium hydroxide. The data for this series are given in Table I.

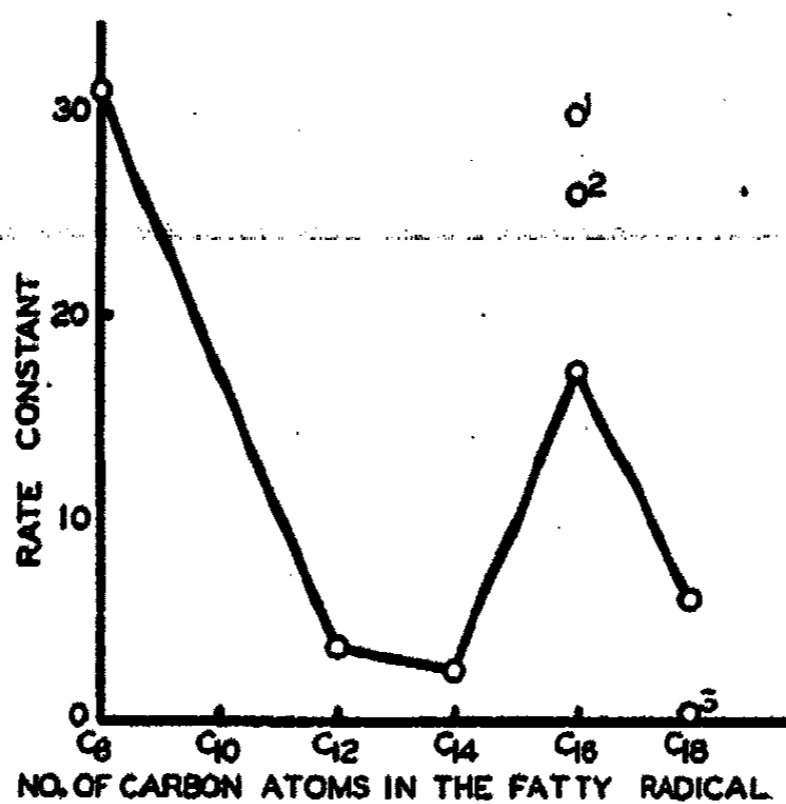

FIG. 1

Rate of saponification of the saturated triglycerides plotted against the number of carbon atoms in a single molecule of the corresponding fatty acid. Numbers 1, 2 and 3 represent the positions of  $\alpha$ -monopalmitin,  $\alpha\alpha$ -dipalmitin and triolein, respectively.

The rate constants for the saponification of the triglycerides are plotted in Fig. 1 against the number of carbon atoms in a single molecule of the fatty acid. One might have expected that there would be a smooth curve either rising steadily or falling steadily when the rates of saponification of the successive members of the homologous series of triglycerides of the saturated fatty acids were compared under these identical conditions.

This is most strikingly not the case. Successive members such as trimyristin and tripalmitin show a difference of many fold in rate, and the next succeeding pair show a change in the opposite direction. The only difference to which one can point is difference in degree of emulsifiability under identical conditions. This is corroborated by the visual appearance of the mixtures which show complete emulsification with the highest rates and very incomplete emulsification for the slower saponifications. One has grown accustomed to taking it for granted that, if a carbon chain is already long, further increase

in length would only produce a steady and often diminishing effect upon the properties of the compound. Here, however, we find a highly marked, specific effect due to the length of the chain and reveal a factor which has never been taken into account in any theory of emulsification.

Tartar, Duncan, Shea and Ferrier<sup>1</sup> now report that the substitution of methyl groups in benzene increases its emulsifiability, but they did not discover any such specific influence of a definite molecular magnitude.

The interpretation of rate of saponification in heterogeneous systems as being primarily dependent upon degree of emulsification constituted a satisfactory explanation of the data referred to in our previous paper. It is likewise in accord with the data of Table I. For example, the degree of emulsification of triolein, with its slow rate of saponification, is visibly far less than with the saturated derivative, tristearin. Similar considerations apply to the mono- and dipalmitin in Table I. It is of interest to note that determinations of the surface tensions (against air) of the four highest triglycerides showed that they were in inverse order of the corresponding rates of saponification. It is evident that the surface tension of a liquid is by no means wholly determined by the exposed end grouping of the molecule in the outside layer.

In a few experiments previously reported it was found that the rate was not strictly monomolecular with respect to hydroxyl ion, for the rate constant increased as the reaction proceeded. There were two alternative explanations. The first was the well demonstrated fact that the emulsifying power of soap is greatly dependent upon the exact alkalinity of the solution, often passing through a maximum for small additions of alkali. This is probably the principal factor. The phenomenon was noticed chiefly in very slow rates of saponification. It might then be explained as due to a gradual accumulation of intermediate products of saponification such as the di- and monoglycerides. In order to see if this actually would increase the rate of reaction, the experiments in Table I were carried out. They show that there is a real increase in rate when passing from triglyceride through diglyceride to monoglyceride, but in the case of the palmitins the whole effect does not amount to a doubling of the rate. Hence the small accumulation that can occur in an oil under saponification cannot greatly increase the rate, and the first explanation given above must therefore be predominant.

## Part II

### *Dependence of Rate of Saponification upon the State of the Soap System.*

A series of studies of the phase rule equilibria of soaps<sup>2</sup> have defined the conditions under which soap solutions assume their various distinctive

<sup>1</sup>H. V. Tartar, C. W. Duncan, T. F. Shea and W. K. Ferrier: *J. Phys. Chem.*, 33 435 (1929).

<sup>2</sup>J. W. McBain and A. J. Burnett: *J. Chem. Soc.*, 121, 1320 (1922); J. W. McBain and G. M. Langdon: 127, 852 (1925); J. W. McBain and W. J. Elford: 1926, 421; J. W. McBain and M. C. Field: *J. Phys. Chem.*, 30, 1545 (1926); J. W. McBain and A. V. Pitter: *J. Chem. Soc.*, 1926, 893; J. W. McBain and L. H. Lazarus: communicated to *Z. physik. Chem.*; J. W. McBain: *Colloid Symposium Monograph*, 4, 7 (1926); J. W. McBain: Chapter V in Jerome Alexander's "Colloid Chemistry" (1926).

forms and place us in a position to determine the effect of the physical state of the soap solution upon the rate of saponification. In a previous paper<sup>1</sup> it was shown that with the soap in homogeneous isotropic solution the rate constant was increased on addition of salt, decreasing upon salting out into two liquid layers but giving the highest value when the soap is grained out with excess of salt. However, the soap solutions previously dealt with have been moderately dilute, and the present work is intended to supply a more

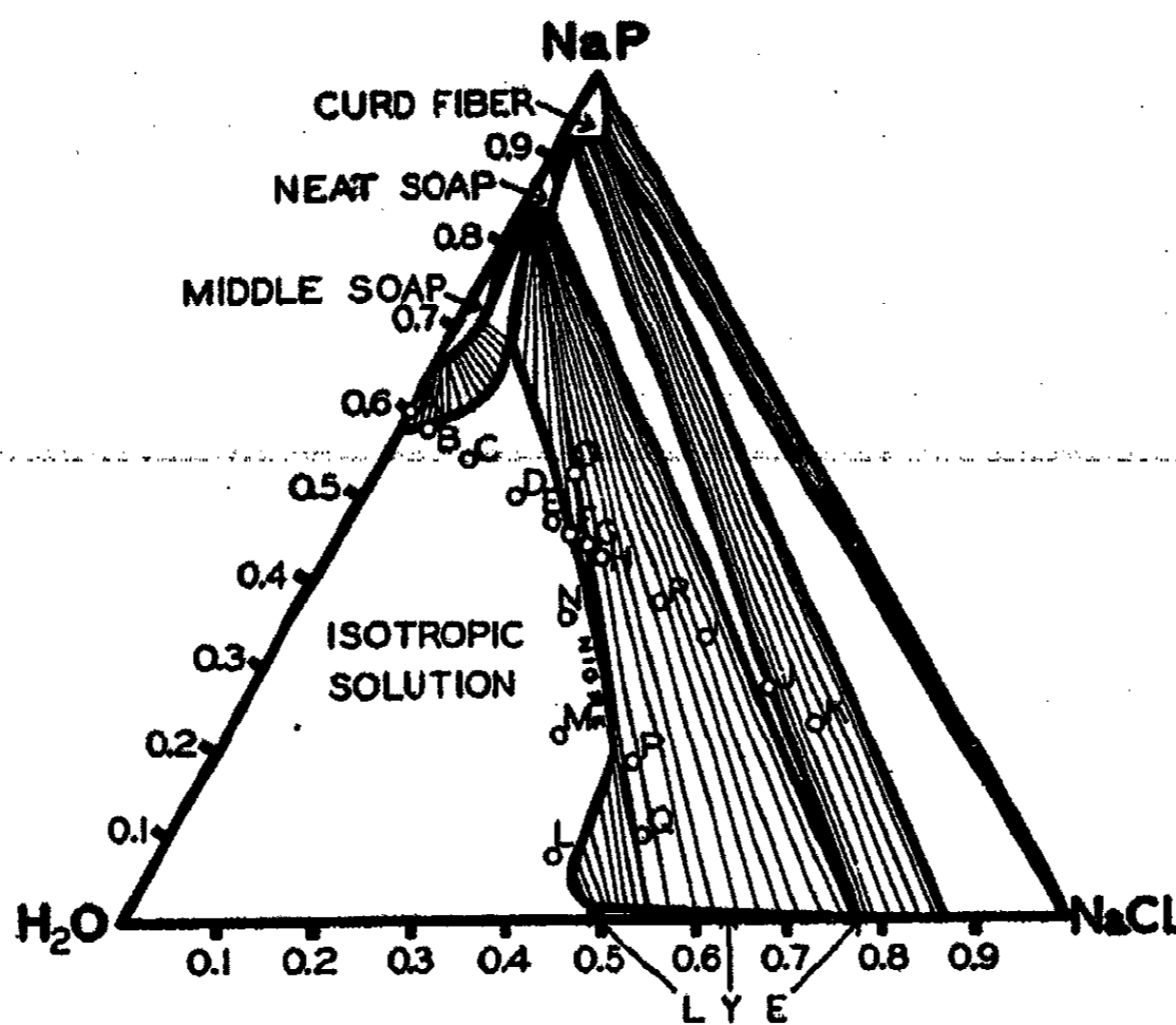

FIG. 2

Phase rule diagram of sodium palmitate, sodium chloride and water at  $90^\circ$ , showing the systems which were used as emulsifying agents in the saponification of coconut oil in Tables II, III and IV. A is a mixture of middle soap and isotropic solution. B, C, D, E, L, M and N are in the homogeneous isotropic region. F and O are a mixture of nigre and neat soap. G, H, R, P, Q and I are neat soap and lye. J is a mixture of neat soap, curd fiber and lye, and K is curd fiber and lye.

complete series of data, particularly with such concentrations as would bring the system into the regions used in commercial soap boiling. The soap chosen was pure sodium palmitate with various additions of NaCl, and the rate of saponification of coconut oil was studied in its presence.

Fig. 2 supplies an index to this series of experiments each of which is indicated by a letter marking the composition and state of the soap system upon the triangular equilibrium diagram for  $90^\circ$ , an explanation of which is to be found in the papers cited. The corners of the diagram represent, respectively, one gram molecular weight of sodium palmitate, one gram molecular weight of NaCl and one kilogram of water; the co-ordinates are

<sup>1</sup> J. W. McBain, H. S. Howes and M. Thorburn: loc. cit.

The fractions or fractional proportions of these three quantities, the sum of which for each point on the diagram is unity. The composition at any point is inversely proportional to the distance from the three respective corners.

Table II presents the data for the effective rate of saponification in the presence of  $1.5 N_w$  sodium palmitate when NaCl is added in increasing amounts. The significance of these data is much better shown by reference to Fig. 3 where the rate constants are plotted against the amounts of NaCl

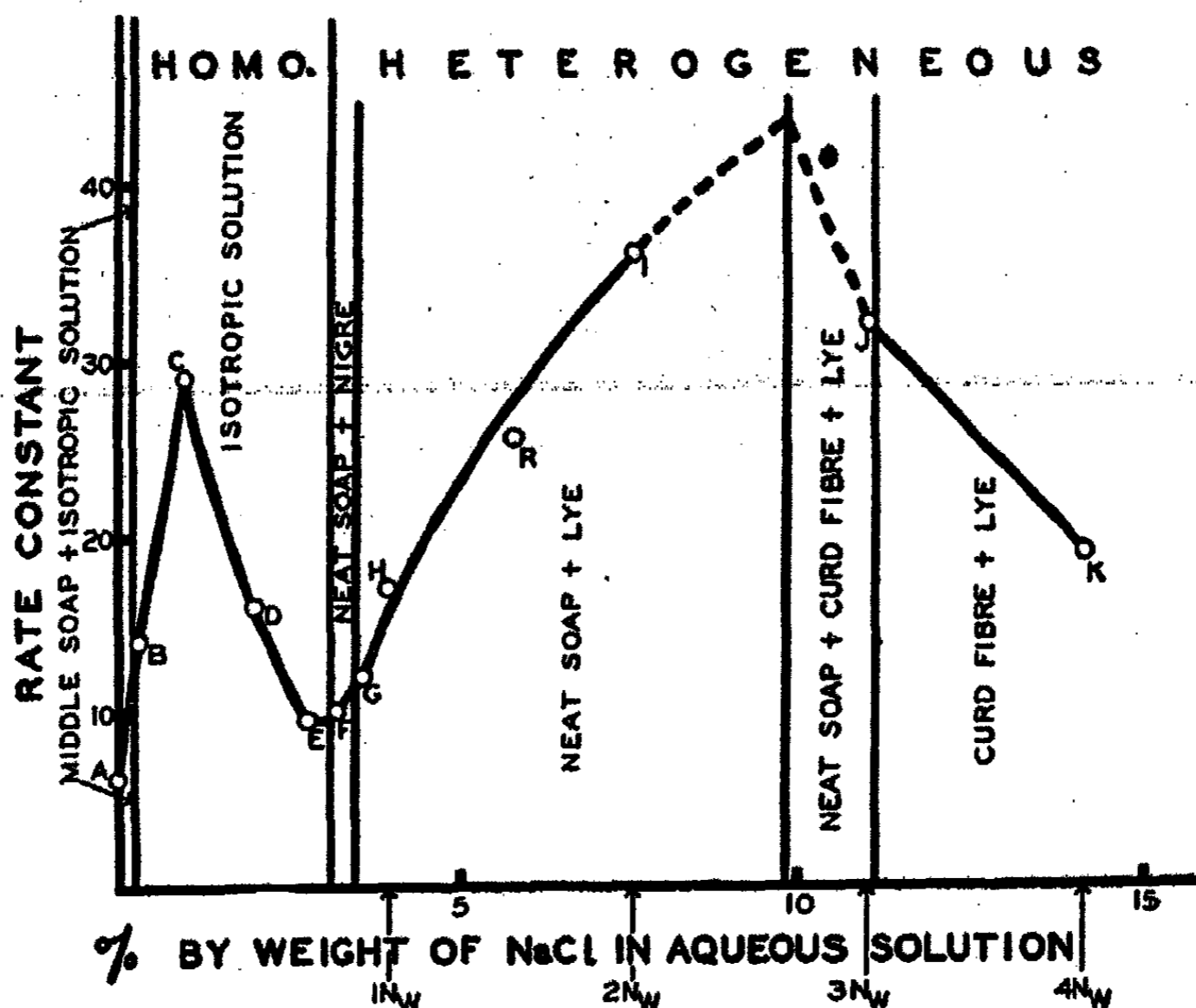

FIG. 3

The rate of saponification of coconut oil at  $90^\circ$ , in presence of  $1.5 N_w$  sodium palmitate that is brought into various states by addition of sodium chloride.

added (expressed in true weight per cent; that is, weight of NaCl in one hundred parts by weight of the aqueous system), and the state of the aqueous soap system is clearly indicated. This diagram correlates the results with those of practical soap boiling and its possible modifications.

The slowest rate of all is observed in the absence of NaCl when the soap is partly middle soap and partly in ordinary isotropic solution. The rate is doubled when, by addition of the minimum amount of NaCl, the middle soap is destroyed and the whole of the soap brought into isotropic solution. At first sight it might have been thought that the rate would be constant and that the graph should be horizontal within the same heterogeneous system. However, this is shown not to be the case by the consideration that, as the heterogeneous system is traversed, the first phase is being replaced

TABLE II

The rate of saponification of coconut oil at 90° when the concentrations of oil, sodium palmitate and the initial concentration of sodium hydroxide are kept constant at 1.0, 1.5 and 0.1 N<sub>w</sub>, respectively, but sodium chloride is added in increasing amounts.

Experiment	Initial Concentration			NaP		Rate Constant K	Mean K	State of aqueous system
	N <sub>w</sub>	NaCl F.P.*	Wt. %	N <sub>w</sub>	F.P.*			
A	0	0	0	1.5	0.6	6.2	6.2	Hetero. Middle + Isotropic
B	0.08	0.031	0.328	1.5	0.58	14.0	14.0	Homo. Isotropic
C	0.25	0.091	1.018	1.5	0.545	29.0	29.0	Homo. Isotropic
D	0.5	0.162	2.015	1.5	0.50	16.0	16.0	Homo. Isotropic
E	0.69	0.216	2.760	1.5	0.470	{ 9.0 10.0	9.5	Homo. Isotropic
F	0.8	0.242	3.185	1.5	0.455	{ 9.6 10.4	10.0	Hetero. Neat + Nigre
G	0.9	0.265	3.569	1.5	0.442	{ 12.4 12.6 11.0	12.0	Hetero. Neat + Lye
H	1.0	0.286	3.950	1.5	0.428	17.0	17.0	Hetero. Neat + Lye
R	1.5	0.375	5.810	1.5	0.375	{ 24.5 26.0	25.6	Hetero. Neat + Lye
I	2.0	0.445	7.600	1.5	0.333	36.0	36.0	Hetero. Neat + Lye
J	3.0	0.545	10.982	1.5	0.273	32.0	32.0	Hetero. Neat + Curd + Lye
K	4.0	0.615	14.126	1.5	0.231	19.0	19.0	Hetero. Curd + Lye

\* Fractional proportion.

by the second phase with its different emulsifying power and hence there is a change in rate whilst crossing the heterogenous zone. This change, in general, would hardly be linear, although for lack of precise investigation it is so drawn in the diagram.

The emulsifying power of ordinary homogeneous soap solutions is very interesting in that, as shown by the rate, it passes through a sharp maximum and then, upon further addition of sodium chloride, falls off to a low value. Thus in Experiment C with the optimum concentration of NaCl the rate is three times greater than that for Experiment E. This increase in rate and emulsifying power with subsequent reversal on further addition of NaCl shows a remarkable parallelism with the viscosity of the soap solution.<sup>1</sup>

The rate is therefore reduced to a minimum when the concentration of NaCl is so increased as to "fit" the soap into the two phases, nigre and neat soap. The rate rapidly rises again to the highest observed value, within the region at which the soap is salted into neat soap and lye. Previous data<sup>2</sup> with sodium palmitate, sodium chloride and tripalmitin (instead of coconut oil), as far as they go, agree with the much more complete data now presented. The tripalmitin series did not contain any data for curded soap, and the highest rate was, like here, obtained in the presence of neat soap. The highest rate is four times greater than the minimum for nigre on the point of salting out to form neat soap. It is noteworthy that the rate in the presence of neat soap rapidly rises with increasing concentration of the lye in contact with it so that the highest rate is obtained just before the appearance of curd fibers in the neat soap. After this, contrary to expectation from the results of Miss Thorburn<sup>3</sup> for coconut oil soap, the rate fell off upon completely salting out the sodium palmitate curd fiber with saturated NaCl, although it was still twice as high as with the mixture of nigre and neat soap. Miss Thorburn obtained the highest rate upon complete salting out of coconut soap curd although, since her data included only a single point involving neat soap, no conclusive comparison between neat soap and grained soap was obtained. It is quite possible that a much faster rate would have been obtained had she tried neat soap with almost enough salt to produce curd fibers. It is arguable from these data that it might be advantageous to expedite the process of saponification by using high concentration both of alkali and of salt, possibly even using a form of crutching machine. Incidentally the excess of salt would liberate glycerine from the soap since, as we shall show in another communication, glycerine is sorbed within the solution of neat soap.

It has been shown elsewhere that all electrolytes, including sodium hydroxide, have a parallel effect upon the state of soap solutions. Graining out with hydroxide instead of chloride has the added advantage of the increased concentration of hydroxyl ions; at least until it is removed by saponification. However, Finch and Karim<sup>4</sup> have found that an excessively high concentra-

<sup>1</sup> J. W. McBain, H. J. Willavoys and H. Heighington: *J. Chem. Soc.*, 1927, 2689.

<sup>2</sup> J. W. McBain, H. S. Howes and M. Thorburn: *loc. cit.*, p. 140.

<sup>3</sup> J. W. McBain, H. S. Howes and M. Thorburn: *loc. cit.*

<sup>4</sup> G. I. Finch and A. Karim: *loc. cit.*



tion such as 54 per cent hydroxide and 46 per cent water results in a slower rate. In their experiments this may have been partly due to decrease in the amount of the aqueous emulsifier.

Microscopic observation showed that curd fibers of soap were more easily wetted both with paraffin oil and with coconut oil than with water. When the soap was completely grained out, the emulsification must be due to the extremely finely divided insoluble curd fibers. It is evident from the foregoing data that neat soap is the best emulsifier and that it is much better than an ordinary soap solution.

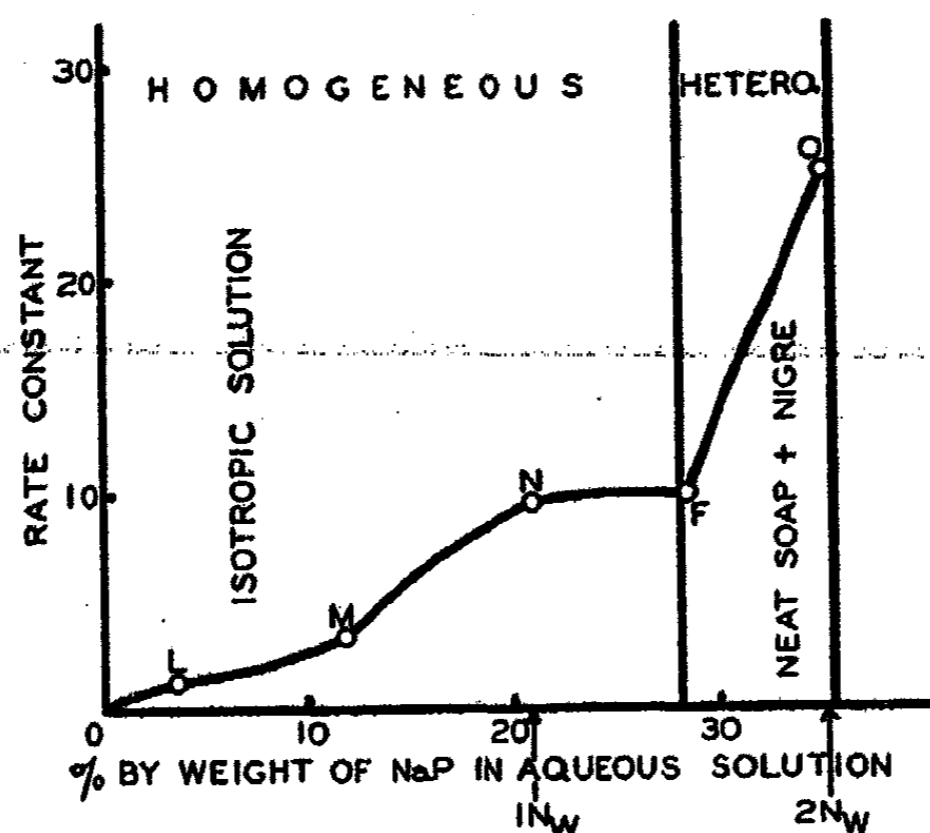

FIG. 4

The rate of saponification of coconut oil at  $90^\circ$  in presence of 0.8  $N_w$  sodium chloride, sodium palmitate being added in varying amounts.

The excellent emulsifying power of neat soap is demonstrated in the other experiments of this series as shown graphically in Fig. 4 and in Table III. The effect of increasing the concentration of soap is great, but it is still further enhanced upon the appearance of neat soap. There is no discontinuity at the boundary between the homogeneous and the heterogeneous regions for the reasons already discussed.

With regard to Experiments L and M, it is necessary to point out that the soap was in too low concentration to keep the environment quite constant throughout the reaction and therefore the rate departed from a strict proportionality to the hydroxyl ion. Hence the constants quoted are those for the beginning of the reaction.

In the remaining experiments of this series the concentration of oil and the initial concentration of alkali were kept constant as before, but the concentrations of soap and of salt were so varied that in each case lye of the same concentration and neat soap of fixed concentration were present but in

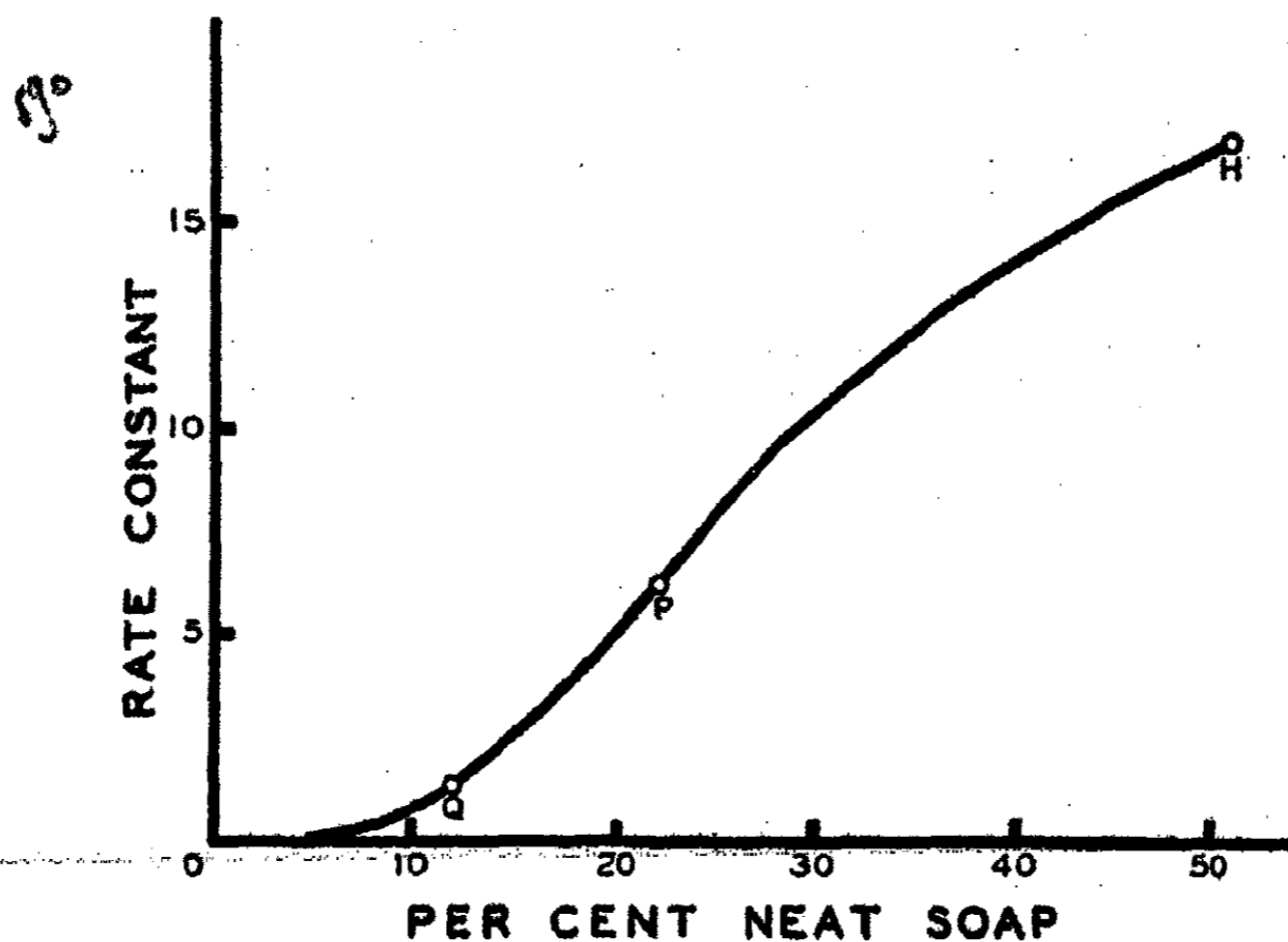

FIG. 5

The rate of saponification of coconut oil at 90° when the concentration of sodium chloride and sodium palmitate are varied together so as to keep the system on the same tie line between neat soap and lye.

TABLE III

The rate of saponification of coconut oil at 90° when the concentrations of oil, sodium chloride and the initial concentration of sodium hydroxide are kept constant at 1.0, 0.8 and 0.1  $N_w$ , respectively, but sodium palmitate is added in increasing amounts.

Experi- ment	Initial Concentration				Wt. %	Rate Con- stant K	Mean K	State of aqueous system
	$N_w$	NaCl F.P.*	$N_w$	NaP F.P.*				
L	0.8	0.41	0.15	0.077	3.824	1.3	1.3	Homo. Isotropic
M	0.8	0.348	0.5	0.218	11.702	3.4	3.4	Homo. Isotropic
N	0.8	0.286	1.0	0.357	20.952	9.2 9.6 10.0	9.6	Homo. Isotropic
F	0.8	0.242	1.5	0.455	28.448	9.6 10.4	10.0	Hetero. Neat + Nigre
O	0.8	0.211	2.0	0.527	34.645	25.0	25.0	Hetero. Neat + Nigre

\* Fractional proportion.

different proportions. The data are given in Table IV and in Fig. 5. It is shown that the rate is inappreciable in the presence of lye alone but becomes very high as the lye is replaced by neat soap. 591

TABLE IV

The rate of saponification of coconut oil when the concentration of oil and the initial concentration of sodium hydroxide are kept constant at 1.0 and 0.1  $N_w$ , respectively, but the concentrations of sodium chloride and sodium palmitate are varied together so as to keep the system on the same tie line between neat soap and lye, thus merely changing the proportions of neat soap and lye.

Experiment	Initial Concentration				Percent Neat Soap	Rate Constant K
	$N_w$ NaCl	F.P.*	$N_w$ NaP	F.P.*		
H	1.0	0.286	1.5	0.428	51	17
P	1.18	0.440	0.5	0.187	22	6.2
Q	1.22	0.494	0.25	0.101	12	1.3

\* Fractional proportion.

### Part III

#### *Soya Bean Oil; Effects of Hydrogenation and Admixture with Castor Oil.*

In the previous communication<sup>1</sup> it was shown that, in general, with many exceptions the rate of saponification diminishes with increasing unsaturation in a series of various fats and oils. It was of interest, therefore, to test whether for a given oil the rate of saponification would steadily increase as the oil was progressively hydrogenated. For this purpose various samples of soya bean oil were saponified as shown in Table V. We did not succeed in reducing the iodine value below 12.2 and probably for that reason did not attain the much higher rates expected for a completely saturated oil. It is seen that partial hydrogenation diminishes instead of increasing the rate; but, after the rate has passed through a minimum, further hydrogenation produces the expected increase in rate.

TABLE V

#### Effect of Progressive Hydrogenation of Soya Bean Oil upon Its Rate of Saponification

Iodine Value	143	116	100	79.5	62.5	49.1	39.9	20.7	12.2
Rate Constant	0.40*	0.25	0.14	0.15	0.17	0.14	0.24	0.37	0.74
		0.38					0.27	0.43	

\* Determined by Mr. Humphreys.

This more complicated relation helps to explain why there is no quantitative relation between iodine values of different oils and their rates of saponification under identical conditions.

<sup>1</sup> J. W. McBain, C. W. Humphreys and Y. Kawakami: loc. cit.

Finally, mixtures of soya bean and castor oils in all proportions were saponified under the conditions described in the previous communication in order to see whether the rate varied linearly with the proportion of the two oils present. Castor oil alone saponifies one hundred times faster than soya bean oil alone. The results in Table VI show that the rate does vary linearly with the proportions of oils, but that a large addition of soya bean to castor oil hardly slows the reaction, whereas, on the contrary, a small addition of castor oil to soya bean increases the rate by much less than linear proportion.

TABLE VI  
The Rate of Saponification of Various Mixtures of Castor Oil and  
Soya Bean Oil under Identical Conditions

% Castor Oil	100	50	25	12.5	5	0
% Soya Bean Oil	0	50	75	87.5	95	100
Rate Constant	36.7	33.0	16.0	5.2	0.85	0.39

#### Summary

1. Neighboring triglycerides in homologous series show very different degrees of emulsification under identical conditions, revealing a surprising and highly specific effect of the exact length of long hydrocarbon chains.
2. The emulsifying power of ordinary soap solutions upon addition of sodium chloride passes through the same striking maximum as does the viscosity.
3. In a quantitative determination of the separate factors which govern the rate of saponification of oils and fats by aqueous alkali, it is found that no matter how complicated the system, the rate is almost exactly proportional to the concentration of hydroxyl ions. For the rest, it is almost entirely dependent upon the degree of emulsification of the oil. This depends upon the state of the aqueous alkaline soap solution, which in its turn is governed by the total amount of electrolyte. Neat soap is the best emulsifying agent, especially in the presence of the maximum amount of salt which can be added without graining out the soap, but insoluble, fully grained out curd fibers are also good. From a consideration of the parallel salting out action of hydroxide and chloride and the data obtained, practical conclusions with regard to the modification of the first stages in soap boiling practice are readily deducible.

*Department of Chemistry,  
Stanford University,  
California.*

# THE PHASE DIAGRAM FOR THE SYSTEM SULFUR-NAPHTHALENE AND ITS RELATION TO INTROFACTION\*

BY HAMNETT P. MUNGER WITH MARC DARRIN AND GEBHARD STEGEMAN

## I. Introduction

This investigation was undertaken to determine whether the phase diagram for naphthalene and sulfur might offer some explanation for the change in the rate of impregnation of sulfur into specific materials on the addition of substances called introfiers. An introfier is a substance which facilitates impregnation.

A. *Previous Work.* It has been shown by Darrin<sup>1</sup> that several groups of organic substances act as introfiers in the impregnation of fibrous material by sulfur. The molecular structure required by sulfur introfiers is a plurality of cyclic nuclei.<sup>2</sup>

The binary systems, consisting of sulfur and a sulfur introfier, which have been investigated are triphenyl-methane-sulfur,<sup>3</sup> quinoline-sulfur,<sup>4</sup> p-dichlorbenzene-sulfur.<sup>5</sup> The data for these substances were not sufficiently complete to give an explanation for their introfying property.

Naphthalene is one of the most practical sulfur introfiers and was used during this investigation.

## II. Experimental

A. *Materials.* Pure, resublimed naphthalene (m. pt. 80.1°C.) and rolled sulfur (99.9%) were used in this investigation. Appropriate quantities of the materials were sealed in Pyrex tubes, 15 mm × 100 mm. The tubes were kept in an oven at 125°C.

B. *Apparatus.* The freezing point measurements were made in a paraffin bath. The mechanism used to keep the sample uniformly mixed consisted of a rocking frame kept in motion by an eccentric. The temperature of the bath was measured by a thermometer graduated in 1/10°C. The thermometer was calibrated by comparing it with a Bureau of Standards thermometer.

C. *Procedure.* In order to obtain the freezing point of a mixture of naphthalene and sulfur, the tube containing the mixture was placed in the bath and cooled until crystals appeared. By heating the bath gradually and

\* Presented to the Chemistry Department of the University of Pittsburgh by Hamnett P. Munger in partial fulfillment of the requirements of the degree of Doctor of Philosophy. Contribution No. 181 from the Department of Chemistry of the University of Pittsburgh.

<sup>1</sup> Darrin: Ind. Eng. Chem., 20, 801 (1928).

<sup>2</sup> Darrin: U. S. Patent 1,644,711 (Oct. 11, 1927).

<sup>3</sup> Smith, Holmes, and Elliott: J. Am. Chem. Soc., 27, 797 (1905).

<sup>4</sup> Hamnick and Holt: J. Chem. Soc., 130, 1995 (1926).

<sup>5</sup> Bruni and Pellizzola: Atti. Accad. Lincei, 30II, 158; Chem. Abs., 17, 2814 (1923).

allowing time for equilibrium to be established between the solid and liquid, a temperature was found at which the solid phase was in equilibrium with the liquid phase, and which was  $0.1^{\circ}\text{C}$ . below the temperature at which only the liquid phase was present. This temperature was the freezing point of the mixture.

The composition of the solid phases was determined by analyzing large crystals which were obtained by carefully cooling the mixtures in the tubes. The desired crystal type was obtained by regulating the rate of cooling and the temperature at which the solid phase separated. The different crystals were easily identified by their form.

### III. Results

A. *The Phase Diagram.* The freezing point curves for the various solid phases are shown in Fig. 1. From the graph, it will be seen that there are three stable solid phases in contact with the liquid phase, namely, monoclinic sulfur (A-B), solid solution of naphthalene in sulfur (liquidus C-D, solidus G-H), naphthalene (E-F). A metastable phase, a second solid solution of naphthalene in sulfur (liquidus K-L, solidus M-N) is shown.

B. *Relation to Introfaction.* Two very important factors, in the penetration of solids by liquids, are viscosity and surface tension. It has been found that the decrease in the freezing point of a mixture is usually accompanied by a corresponding decrease in viscosity.

It has been pointed out by Darrin<sup>1</sup> that solubility is often an indication of introfying properties but not a measure of this property. A decrease in the freezing point of a mixture indicates an increase in mutual solubility of the two components. An interesting comparison can be drawn from the data on impregnation shown in Table I and the freezing-point data obtained in this investigation. From a comparison of the ratios of the increase in impreg-

TABLE I  
Impregnation of Fiberboard with Sulfur using Naphthalene  
as the Introfier after Different Immersion Periods\*

Mixture	0 Min.	1 Min. %	5 Min. %	15 Min. %	Freezing Point**
Pure Sulfur		28	31	35	$117.5^{\circ}\text{C}$
5% Naphthalene		84	108	148	108.8
Difference		56	77	113	8.7
10% Naphthalene		111	130	173	104.6
Difference		83	99	138	12.9
Ratio of Diff. 5% : 10%	0.635***	0.675	0.78	0.82	0.620

\* Impregnation data secured from Darrin<sup>1</sup>

\*\* Freezing-point data from present investigation.

\*\*\* Extrapolated.

<sup>1</sup> Loc. cit.

nation by using 5 and 10 per cent of naphthalene in sulfur with the ratio of the decrease in freezing point of these same mixtures, the close agreement between the ratios for one minute impregnation and the freezing point lowering is suggestive. If these results are extrapolated in order to obtain the ratio of the initial introfying power, the result is even more remarkable. It is to be remembered that after impregnation has begun, other factors, such as the degree of saturation of the fibrous material, etc., enter in to decrease the effectiveness of the introfier.

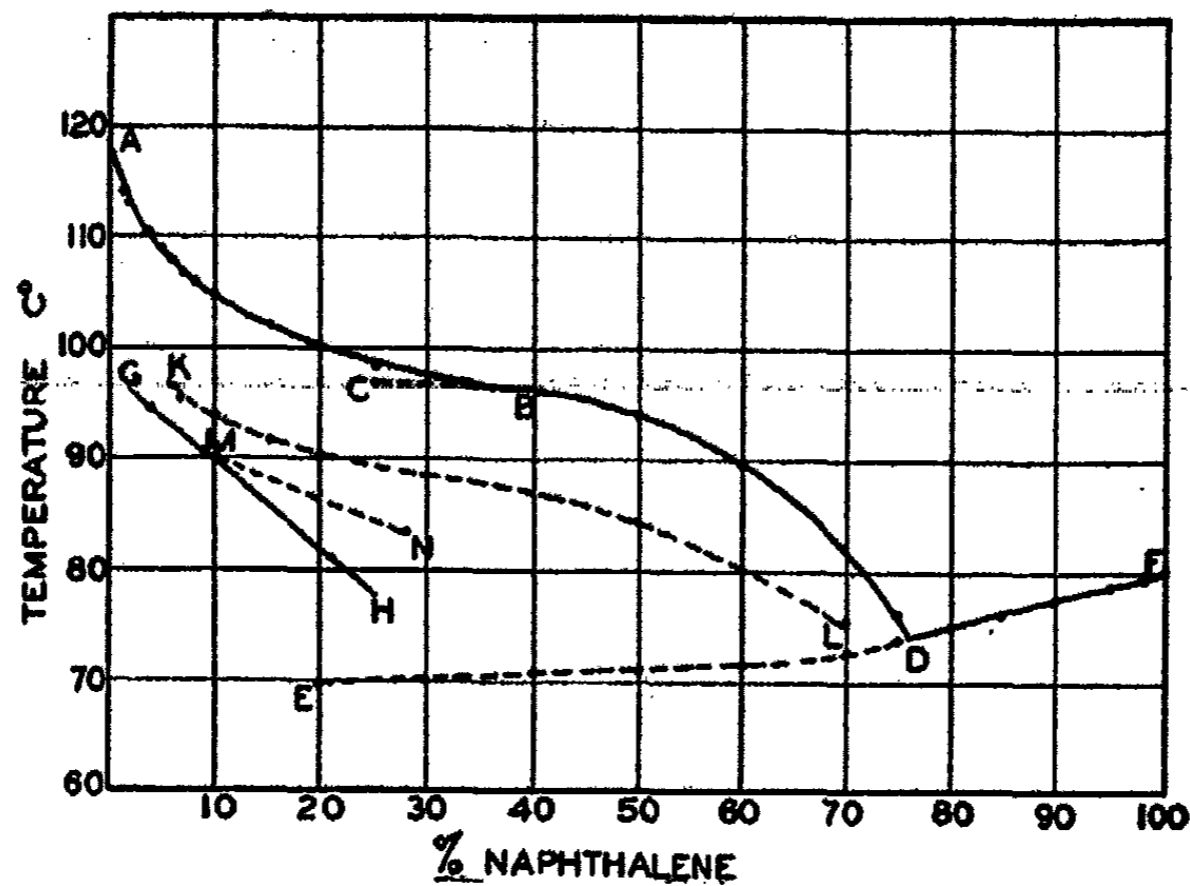

FIG. 1

Although the depression of the freezing point of sulfur is apparently a measure of the initial introfying power of the introfier, this freezing point lowering can not be taken as a criterion of substances having introfying properties. An introfier must first have the ability to change the specific wetting properties of sulfur before its relative effectiveness can be predicted from freezing point data.

*Pittsburgh, Pennsylvania.*

## TEMPERATURE COEFFICIENTS OF THE DECOMPOSITION OF ACETONE DICARBOXYLIC ACID IN WATER\*

BY EDWIN O. WIIG

The decomposition of acetone dicarboxylic acid in aqueous solution has previously been studied<sup>1</sup> at 40°, 50°, and 60°C. The reaction was found to be unimolecular and may be represented by the equation

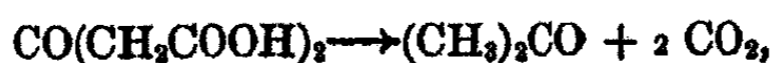

the rate of reaction having been followed by measuring the volume of carbon dioxide liberated. The object of the present work was to measure the velocity of decomposition down to 0°C. in order to test, over a wide range of temperatures, the Arrhenius equation expressing the relation between absolute temperature and the velocity constant.

### Materials and Procedure

The acetone dicarboxylic acid was prepared and purified as described in the earlier work. The water in which the acid was dissolved was ordinary laboratory distilled water which had been boiled vigorously to remove carbon dioxide.

The aqueous solution of acetone dicarboxylic acid was placed in an 8'' Pyrex test tube which was immersed in a thermostat. At 0° the Pyrex test tube containing the reaction mixture was placed in a thermos bottle containing ice and water, and this bottle was kept in a jar of ice water. The rate of decomposition was followed by titrating the undecomposed acetone dicarboxylic acid with N/10 NaOH. Since carbon dioxide is one of the products of decomposition and would be titrated by the alkali, it was necessary to remove it. This was accomplished by bubbling a stream of nitrogen or oxygen gas rapidly through the solution. The velocity constant obtained at 40°C. by this method checked very well with that previously determined gasometrically, the two values for  $k \times 10^4$  being 57.6 and 57.0 respectively. This indicates that the method used is satisfactory.

### Results

The results obtained are summarized in Table I, the data for 50° and 60°C. having been taken from the previous work. The value of  $k$ , the velocity constant, was calculated from the well known equation for a mono-molecular reaction. The velocity constant increased slightly in any one experiment but was constant between 50% and 75% decomposition. The values of  $k$

\* Contribution from the Laboratories of General Chemistry of the University of Wisconsin. Presented at the Seventy-Seventh Meeting of the American Chemical Society, Columbus, Ohio, April 29-May 3, 1929.

<sup>1</sup> J. Phys. Chem., 32, 961-81 (1928).



given in the table are the average of the velocity constants obtained between 50% and 75% decomposition in three experiments, except at 0°C. in which case  $k$  is the average obtained from two experiments.

TABLE I  
Effect of Temperature on the Reaction Rate  
Initial Concentration of Acetone Dicarboxylic Acid = 68.5 mols. per liter

Temp. °C.	$K \times 10^4$	Temperature Coeff.	Critical Increment (E)
60	548		
		.....2.96.....	23,100
50	185		
		.....3.25.....	23,600
40	57.6		
		.....3.53.....	23,700
30	16.3		
		.....3.75.....	23,200
20	4.35		
		.....4.03.....	22,900
10	1.08		
		.....4.39.....	22,600
0	0.246		

The value of the critical increment,  $E$ , was calculated from the Arrhenius equation

$$\frac{d \ln k}{dT} = \frac{E}{RT^2}$$

using the integrated form

$$E = \frac{1.98 T_2 \times T_1 \times 2.303 \log k_2/k_1}{T_2 - T_1}$$

where  $k_2$  and  $k_1$  are the velocity constants at the absolute temperatures  $T_2$  and  $T_1$  and  $E$  is expressed in calories. The values of  $E$  vary somewhat but are about within the limits of experimental error, the maximum deviation from the mean value of  $E$  being about 3%. The fact that the value of  $E$  has been found to be constant within the limits of experimental error over the temperature range 0° to 60°C. indicates that the Arrhenius equation holds true.

#### Summary

1. The rate of decomposition of acetone dicarboxylic acid in aqueous solution has been measured at 0, 10, 20, 30, and 40°C.
2. The critical increment,  $E$ , has been calculated from the temperature coefficients obtained.
3. The value of  $E$  was found to be constant within the limits of experimental error over the temperature range 0° to 60°C., indicating the validity of the Arrhenius equation.

Madison, Wisconsin

## THE COMPLEX NATURE OF DIELECTRIC ABSORPTION AND DIELECTRIC LOSS

With Particular Reference to the Influence of Ions adsorbed on Inner Surfaces.

BY E. J. MURPHY AND H. H. LOWRY

### Introduction

In recent years many facts have been discovered which indicate that in most solid dielectrics direct-current conduction does not take place uniformly through the material as a whole but along paths of higher conductivity than the main part of the dielectric. Since these paths are of sub-microscopic dimensions the interfacial area of their boundaries should be large in comparison with their volume, and it would consequently be expected that the ions adsorbed by the interface between the conducting medium and the insulating medium may have important effects on the electrical properties of dielectrics. The following discussion is primarily an inquiry into the nature of the effects which the ions in a dielectric would have upon dielectric absorption (i.e., the formation of a residual charge) and dielectric loss<sup>1</sup> on the assumption that besides free ions solid dielectrics may contain ions adsorbed by the above-mentioned inner surfaces, or associated in some equivalent way with neutral molecules. Consideration of the physical, chemical, and electrical properties of dielectrics also suggests that it would be advantageous in general to divide dielectric absorption and dielectric loss into components based upon different physical mechanisms, where there are independent evidences of the existence of these mechanisms. The characteristics of dielectric absorption and loss are therefore discussed here on the basis of a division of these quantities into components due to free ions, to adsorbed ions, and to neutral molecules. The relative prominence of each of these components should depend on the nature of the dielectric, the temperature and other factors. Before discussing the characteristics of dielectric absorption and loss, it seems desirable to discuss the general picture of the structure of dielectrics which appears to be warranted by recent data, and to outline the electrical properties which materials with such a structure would be expected to have.

<sup>1</sup>The most recent discussions of these subjects have been given by Whitehead: *J. Am. Inst. El. Eng.*, 45, 515 (1926); Whitehead and Marvin: 48, 186 (1929); Kitchen: 48, 281 (1929); Kitchen and Muller: *Phys. Rev.*, (2), 32, 929 (1928); Schiller: *Z. Physik*, 42, 246 (1927); 50, 577 (1928); *Ann. Physik* (4), 81, 88 (1926); Joffé: "Physics of Crystals" (1928); *Ann. Physik*, 72, 495 (1923); *Z. Physik*, 48, 288 (1928); Sinjelnikoff and Walther: 40, 786 (1927); Neumann: 45, 717 (1927); Hartshorn: *J. Inst. El. Eng.*, 64, 1152 (1926); K. W. Wagner: Schering's "Die Isolierstoffe der Elektrotechnik" (1924).

### Evidences for the General Occurrence of "Interstitial Conduction"

The work of A. Smekal<sup>2</sup> in the past few years has shown that in crystalline dielectrics at ordinary temperatures, or at least in those which are ionic conductors, the ions which take part in conduction are concentrated in positions in the crystal where lattice imperfections are present. It is suggested also that these ions are produced by thermal dissociation within the spaces bounded by the inner crystalline surfaces and move in an adsorbed condition along paths formed by these crystalline fissures. This mechanism of conduction is supported by indirect evidences provided by the mechanical and optical properties of crystals, as well as by the form of the conductivity-temperature curve for such crystals, by the conductivity-voltage relationship, and by the influence of impurities. The theory proposed by Smekal has recently been the subject of several investigations, the majority of which favor it.<sup>3</sup> While the gross structure of the moisture-absorbing dielectrics differs from that of the crystalline dielectrics studied by Smekal and others, the assumption that conduction takes place through water which occupies spaces between the insulating micelles of the main constituent of the material also gives consistent plausible explanations of their electrical behavior.<sup>4</sup> The structure recently given by Meyer and Mark<sup>5</sup> for cellulose and a variety of similar materials, based on a review of existing röntgenographic and other evidence is in agreement with the structure which has been proposed to explain the electrical properties of these materials. Thus both types of dielectric, though quite different in some respects, have the common property that conduction takes place through conducting paths distributed in an insulating medium; such a system may perhaps appropriately be called an "interstitial conduction" system because it consists of conducting paths dispersed in the interstices between relatively non-conducting structural units of the material.

These interstitial spaces are not in general to be regarded as accidental occurrences—though it may not be proven beyond question that they are not accidental—but as a normal part of the structure of the materials. Smekal,<sup>6</sup> from a study of a large number of substances, estimates that the ideal part of the lattice in a crystal unit contains  $10^4$  to  $10^5$  atoms or molecules. This is supported by Zwicky<sup>7</sup> who attributes to crystals a mosaic structure in which the dimensions of the elements are about  $50\text{Å}$ . Even in

<sup>2</sup> Smekal: *Physik. Z.*, 26, 707 (1925); *Ans. Akad. Wiss. Wien.*, 63, 195 (1926); *Z. techn. Physik*, 8, 72, 203, 561 (1927); *Ann. Physik*, (4) 83, 1202 (1927); *Z. Physik*, 45, 869 (1927).

<sup>3</sup> Blüh and Jost: *Z. physik. Chem*, B1, 270 (1929); Gingold: *Z. Physik*, 50, 633 (1928); Gyulai and Hartley: 51, 378 (1928); Cf. also Traube and v. Behren: *Z. physik. Chem.*, A138, 85 (1928); Zwicky: *Proc. Nat. Acad. Sci.*, 15, 253 (1929); v. Hevesy: *Z. physik. Chem.*, 101, 337 (1922); 127, 401 (1927); Joffe: *loc. cit.*, ref. 1.

<sup>4</sup> Murphy: *J. Phys. Chem.*, 32, 1761 (1928); 33, 197, 509 (1929).

<sup>5</sup> Meyer and Mark: *Ber.*, 61, 593 (1928).

<sup>6</sup> Smekal: *Ann. Physik*, (4) 83, 1202 (1927).

<sup>7</sup> Zwicky: *loc. cit.*, ref. 3.

some liquids, particularly those with a mesomorphic phase,<sup>8</sup> there is a tendency for aggregates of about  $10^5$  molecules to form.<sup>9</sup>

These facts all appear to support Smekal's conclusions regarding the existence of crystal imperfections and their importance in explaining the phenomena associated with electrical conduction in crystals. With an analogous picture of the conducting paths in moisture absorbing dielectrics, we have also obtained qualitative agreement with the mechanism of electrical conduction in textiles. As already mentioned it is highly probable that in such interstitial conduction systems the adsorption of ions at the boundary surfaces between the conducting paths and the insulating structural elements of the dielectric would have important effects owing to the large ratio of interfacial area to volume which would characterize conducting paths of sub-microscopic dimensions.

Since therefore it is necessary to consider the adsorption of ions in discussing electrical properties, it may be advantageous to recall certain properties characteristic of an adsorption system. For instance, if the total number of ions in such a system remains constant an increase in temperature will decrease the number of adsorbed ions, thereby increasing the number of free ions. As a result of this one might expect that the electrical properties determined by the number of adsorbed ions might become relatively less important as the temperature increases. Another common effect of temperature is to increase the total concentration of ions, which in turn will increase the number of adsorbed ions. Since, however, there is no strict proportionality between the total concentrations of ions and the number of adsorbed ions—the number of adsorbed ions being proportional to a fractional power of the concentration—at low concentrations an increase in the total number of ions may result in an enhancement of the electrical effects due to the adsorbed ions, while at higher concentrations the effect of the free ions may predominate.

#### General Electrical Properties of an Interstitial Conduction System

The preceding discussion of the structure of dielectrics suggests that the essential form of the internal structures in the dielectric may be schematically illustrated as in Fig. 1-A. It will be noted that the conducting paths do not consist of smooth channels running parallel to the direction of the applied field, a form which would have quite different properties from those about to be described, but that the idealized element of structure consists of an insulating micelle or crystallite (assumed spherical in shape, though any other form would do for our purpose) surrounded by a conducting skin as shown in Fig. 1-B. In crystals the skin may be of the same material as the sphere,

<sup>8</sup> Friedel: *Ann. Physik*, (4) 18, 273 (1922).

<sup>9</sup> Stewart: *Phys. Rev.*, (2), 32, 558 (1928); Krishnamurti: *Indian J. Physics*, 2, 501 (1928); Katz: *Z. angew. Chem.*, 41, 329 (1928); *Naturwissenschaften*, 16, 758 (1928); Katz and Selman: *Z. Physik*, 46, 392 (1928); Ornstein: *Physik. Z.*, 29, 668 (1928); *Ann. Physik*, (4) 74, 445 (1924); Kast: *Physik. Z.*, 29, 293 (1928); Magnus: *Z. anorg. Chem.*, 171, 73 (1928); Jeffreys: *Proc. Camb. Phil. Soc.*, 24, 19 (1928).

but less dense, but in moisture absorbing materials it is to be regarded as a film of water containing a certain concentration of ions. The ions in this skin near the interface between the insulating micelle and the conducting layer will be attracted toward the interface, i.e., adsorbed.

The electrical behavior of such an adsorption system may be quite complex, but the literature on adsorption gives support for attributing to the system the following properties, which are considered the most essential for

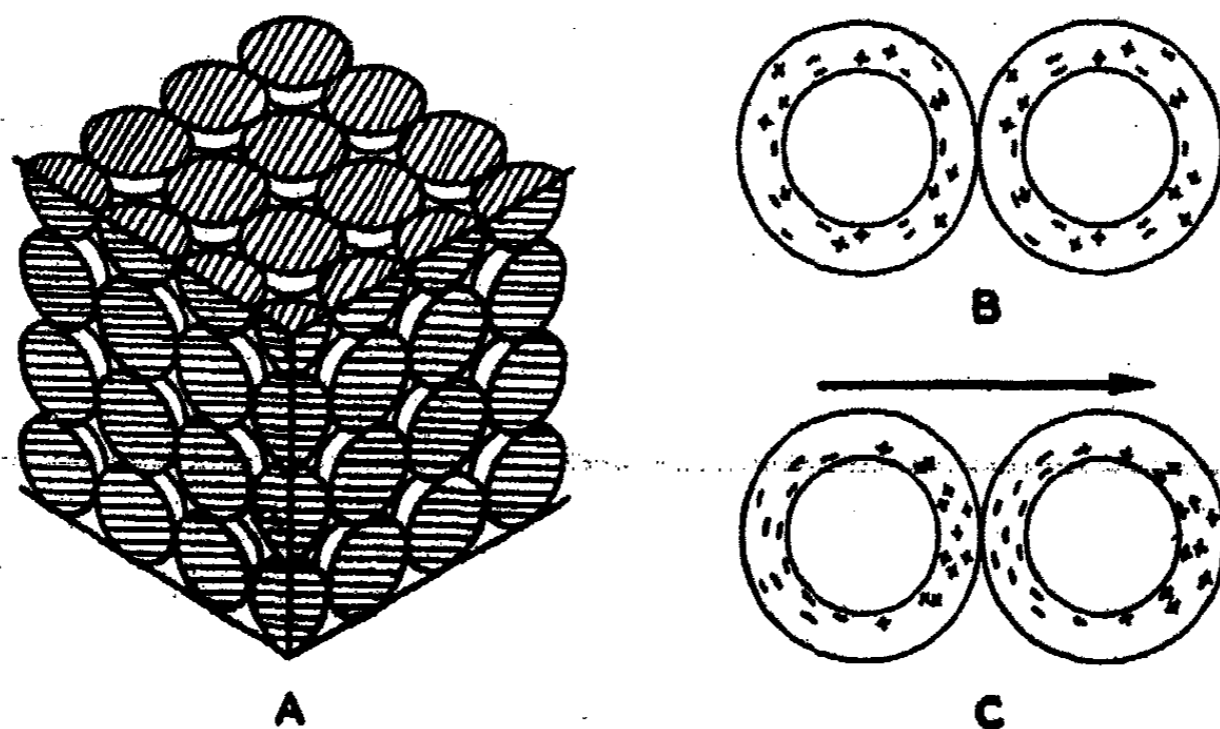

FIG. 1

Illustration of an interstitial conduction system showing the effect of the electric field on the distribution of adsorbed ions.

A. Section of an interstitially conducting dielectric represented schematically. Conduction takes place through the medium which occupies the interstices between the insulating spheres. Each sphere is surrounded by an "atmosphere" of adsorbed ions extending for a small distance away from its surface with gradually decreasing density.

B. This sketch shows the distribution of adsorbed ions around two adjacent insulating spheres in the schematic structure shown in A *before* the application of the electric field. Three concentric layers of ions are shown to illustrate a possible distribution of adsorbed ions in the absence of an impressed electric field. The density of ions in each layer is uniform but is less the greater the distance from the interface. The only significance of the outer circles is to indicate the limits of the atmospheres of adsorbed ions surrounding each sphere. For the present purpose it is not essential that the distribution of the adsorbed ions should be as illustrated, for it is only the change in distribution produced by the electric field which is important.

C. The same as B *after* the application of the field for a sufficient time for the adsorbed ions to assume a polarized distribution under the influence of the electric field. The direction of the field is indicated by the arrow.

the purpose of deriving in a qualitative way the effect of the adsorption of ions on the electrical properties of a dielectric: (a) the adsorbed ions are not rigidly fixed to certain points on the adsorbing surface, but can move over the surface under the influence of an externally applied electric field;<sup>10</sup> (b) they cannot leave the particular structural unit by which they are adsorbed unless a certain threshold voltage gradient, which may be called the "desorption voltage," is exceeded;<sup>11</sup> (c) not all of the ions are adsorbed equally

<sup>10</sup> Volmer and Estermann: *Z. Physik*, 7, 13 (1921); Estermann: 33, 320 (1925).

<sup>11</sup> Polanyi: *Verh. deutsch. physik. Ges.*, 18, 55 (1916); *Z. Elektrochemie*, 26, 370 (1920).

strongly owing to there being several layers of ions,<sup>12</sup> i.e., a decreasing gradient of concentration of adsorbed ions as a function of distance from the interface, as shown by Fig. 2-A. The result would be essentially the same for our purposes whether ions of only one sign or both signs are adsorbed.<sup>13</sup>

One effect of these properties is that when a voltage is applied the least strongly adsorbed ions—those in the outer layers—will become desorbed and join the conduction current, thereby increasing the conductivity. As the voltage gradient is increased, more adsorbed ions would join the conduction current; this explains the increase of conductivity with increasing field strength which is a prominent characteristic of solid dielectrics. This explanation of the voltage effect is equivalent, except for the details of the physical picture, to the mechanism proposed by Smekal.

A second result is that when an electric field is applied the adsorbed ions will move over the surface of the micelle, or crystallite, and accumulate at its poles,—for convenience, defining the axis of these interstitial conduction units as the direction of the electric field—as shown in Fig. 1-C.\* This process of accumulation will continue until the effect of the repulsive forces between like ions equals that of the applied electric field. After the electric field is removed, the adsorbed ions will return to the equilibrium distribution which existed in the absence of the field. The movement of the adsorbed ions on the surface of the micelle or crystallite under the influence of the electric field is equivalent to a condenser charging current and their return to the equilibrium distribution in the absence of the field (i.e., uniform distribution in the case of a spherical micelle, for instance) to a discharge current; the reversible change in the distribution of ions produced by the application of a field may be regarded as equivalent in effect to dielectric polarization, i.e., to the orientation of dipoles in a field and their return to random orientation on its removal, or to the displacement by the field of the charges within a molecule and their return to their normal positions after the removal of the field. In the polarization of the charges within a molecule the internal forces of the molecule are involved, while in the polarization, or redistribution of ions on the surface of a micelle or crystallite the external forces which cause cohesion and adsorption are the bonds which prevent the ions from moving freely in the electric field but allow an elastic displacement of charge. Each micelle or crystallite whose atmosphere of adsorbed ions has been given a polarized distribution by an externally applied electric field may be regarded as an induced dipole. It is recognized that the ions of opposite sign may be in alternate layers, as suggested by Eucken,<sup>13</sup> and that the outermost layers of ions may be considered practically free. In any case, owing to the fact

<sup>12</sup> Gouy: *Ann. Phys.*, 7, 129 (1916); Eucken: *Verh. deutsch. physik. Ges.*, 16, 345 (1914); Polanyi: *loc. cit.*

<sup>13</sup> Eucken: *Z. physik. Chem.*, A138, 375 (1928).

\* If the conduction paths were smooth channels of uniform resistance running through the dielectric in the same direction as the applied electric field, there would be no accumulation of charge either due to the ions adsorbed by the walls or to free ions; but such a representation of the conduction paths would be erroneous since conduction paths running only in the direction of the applied field would not normally occur in dielectrics.

that the dielectric is solid, the micelle or crystallite with its adsorbed ions cannot move as a whole in the electric field even where this unit is not neutral and the electrical effect is therefore similar to that of a large dipole. This means that the ions adsorbed on the inner surfaces of a dielectric can produce a displacement current without producing a space charge. Free ions could not produce a displacement current<sup>14</sup> without producing a space charge<sup>15</sup> at the same time.

The mechanism described above differs from most theories of the effect of ions on dielectric absorption in that the ions do not form a space charge but produce a modified type of dielectric polarization. In a series of recent papers Böning<sup>16</sup> has studied the effects of adsorbed ions on the electrical properties of dielectrics and has developed expressions for a number of relationships assuming that the adsorbed ions are rigidly fixed to points on the walls of the conducting paths. When the ions of opposite sign to the adsorbed ions are removed from the dielectric by the current, he considers that there results a space charge of uniform density. The fact that the mechanism proposed by Böning results in a modified form of space charge while the present one results in a modified type of dielectric polarization is due largely to the fact that Böning considers the adsorbed ions as fixed, while we consider them as capable of movement in the electric field, though only over the surface of the particular micelle or crystallite by which they are adsorbed.

A third property of adsorbed ions which will be important in the consideration of the electrical effects is the existence in general of more than one layer of adsorbed ions, each successive layer in the conducting medium being less strongly adsorbed the greater its distance from the interface in accordance with the theories of Gouy, Polanyi, and Eucken.<sup>12</sup> The rapidity of movement of the adsorbed ions over the surface of an interstitial conduction unit under the influence of the applied electric field will depend on the resistance to motion of the ions. It may be assumed that adsorption reduces the mobility of the ions even in a direction on the average parallel to the surface of the unit.<sup>17</sup> The electric circuit equivalent to the micelle or crystallite with its adsorbed ions would therefore be a capacity in series with a resistance, the magnitude of the resistance being determined by the resistance offered to the motion of the adsorbed ions as they move in the electric field and accumulate at the poles of the structural unit. But if the adsorption of the ions decreases their mobility in the electric field, the amount of the decrease will be smaller the greater the distance of the layer of ions from the interface. Further, if the adsorptive force is a necessary condition for the accumulation of

<sup>14</sup> Except that involved in the ionic atmospheres of the Debye-Falkenhagen theory or unless there were non-uniform resistances on the molecular scale in the conduction paths.

<sup>15</sup> As the term is used here there is no space charge when the potential distribution in the dielectric is uniform on a macroscopic scale.

<sup>16</sup> Böning: *Z. Fernmeldetechnik*, 8, 162 (1927); *Arch. Elektrotech.*, 20, 88 (1928); *Z. techn. Physik.*, 9, 212 (1928); 10, 20 (1929).

<sup>17</sup> Perhaps because of an increase in the density of the conducting medium near the interface, or for other reasons such as the energy of the ion moving in the electric field being partly lost by inelastic collision with adsorption centers into which it falls.

ions, and if it is assumed that it is possible to consider each layer of ions separately, the amount of the accumulation should be less the greater the distance from the interface of the layer of ions considered. The same conclusion may be reached if one considers that owing to the lower desorption voltage of ions in the outer layers they could not accumulate to the same extent as those in the inner layers.

These considerations lead to the representation of the equivalent electrical circuit for the structural unit with its adsorbed ions as in Fig. 2B, where each layer of adsorbed ions is represented by a capacity in series with a

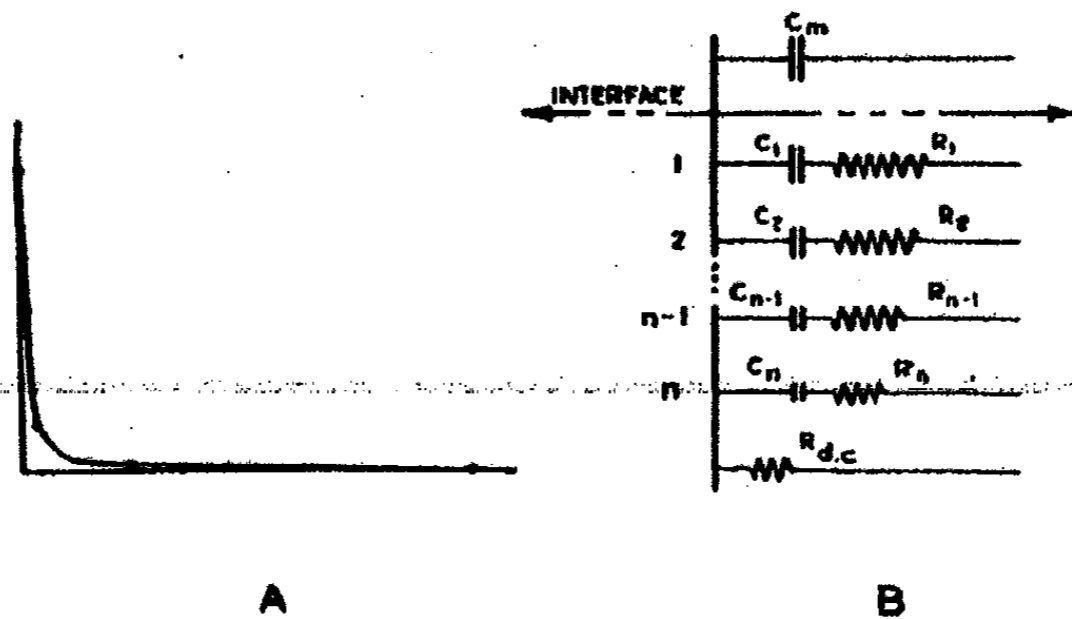

FIG. 2

Representation of adsorbed ion displacements by equivalent electric circuit, showing the assumed relation of density of ions to relaxation time.

A. This curve represents the density of adsorbed ions vs. distance from the interface as calculated from observed data on the basis of Polanyi's theory. It is Fig. 4 of Polanyi's paper in *Verh. deutsch. physik. Ges.*, 18, 55 (1916).  $\delta$  is the density in mol/liters.  $\varphi$  is the volume in liters, and is a function of the distance from the interface.

B. Diagram of circuit equivalent in conductance and capacity to the units of the interstitial conduction system of Fig. 1.  $C_m$  is the capacity due to dielectric polarization of the molecules;  $C_1, C_2 \dots C_{n-1}, C_n$  are the capacities due to the redistribution of adsorbed ions on the surface of the micelles or crystallites.  $R_1, R_2 \dots R_{n-1}, R_n$  are the series resistances equivalent to the frictional resistances which impede the process of forming a polarized distribution of adsorbed ions.  $R_{d.c.}$  is the direct current resistance. Both capacities and resistances decrease as the distance from the interface of the layers of ions to which they refer increases.

resistance, both the capacities and the resistances being smaller the greater the distance from the interface. The essential thing here is that the time constants of each of the condensers with their series resistances are different, and increase the closer the corresponding layer of adsorbed ions is to the interface; that is, the polarized distribution of the adsorbed ions on the surface of each structural unit has a different relaxation time for each layer of adsorbed ions.

#### Dielectric Absorption

The interstitial conduction system described, and particularly the adsorption of ions which is its most essential property for the present purpose, appears to be capable of adequately explaining the characteristics of dielectric absorption. This phenomena may be described as follows: When an e.m.f. is applied to a dielectric the current decreases with time beyond the



time required for charging the geometric capacity of the condenser, and when the voltage is removed and the geometric capacity discharged, a charge still remains in the material. This remaining charge is called the absorbed or residual charge, and the decreasing current is usually called the absorption, or anomalous charging current. Any satisfactory mechanism of dielectric absorption must be able to explain the following important properties: (a) The form of the absorption current-time curve; (b) the superposition principle; (c) the change in the distribution of potential which accompanies the formation of a residual charge in some cases but not in others.

*Form of the absorption current-time curve:* One characteristic of the anomalous charging and discharging currents is that they do not become reduced to zero following an exponential curve, but are usually best represented by an expression of the form  $i = A t^{-n}$ , where  $i$  is the anomalous charging or discharging current,  $t$  the time of charging or discharging, and  $A$  and  $n$  constants;  $n$  is of the order of 0.8.<sup>18</sup> This equation is probably not valid, however, when  $t$  is very small. Theories of dielectric absorption based on a simple mechanism, such as those of Maxwell or Pellat, all lead to an exponential law of decrease of the absorption current with time. To reconcile the Pellat theory<sup>19</sup> with experiment, von Schweidler proposed a mechanism in which each element contributes to the anomalous current according to an expression of the form  $i = \text{const. } e^{-t/T}$ , where  $T$  is a time constant, each element however having a different time constant. The summation of the currents due to a sufficient number of elements of this kind can represent the observed results when the constants are properly chosen, and in particular can represent data which would be satisfactorily expressed by  $i = At^{-n}$ . The preceding discussion of the times of relaxation characteristic of changes in the distribution of adsorbed ions showed that, where there are several layers of them, each layer may have a different relaxation time (cf. Fig. 2-B). The presence in dielectrics of ions adsorbed with varying degrees of intensity therefore provides a new physical interpretation of the Pellat-v. Schweidler<sup>18</sup> theory of dielectric absorption. The charging currents due to the redistribution of adsorbed ions on the surfaces of the micelles or crystallites in a dielectric may therefore be regarded as forming one component of the absorption current. This component may itself be composed of others corresponding to each layer of adsorbed ions. However, free ions, and possibly neutral molecules, can also contribute to the absorption current. The presence of inhomogeneities in the resistance of the dielectric would cause an absorption current due to free ions, as in the Maxwell theory of absorption in dielectrics with layers of different dielectric constant and resistivity. Another way in which free ions may produce a component of the absorption current is through the formation of high resistance layers as a result of the electrode reactions. While all the other components of the absorption current should

<sup>18</sup> v. Schweidler: *Ann. Physik*, (4) 24, 711 (1907); K. W. Wagner: *Arch. Elektrotech.*, 3, 67 (1914); Whitehead and Marvin: *J. Am. Inst. El. Eng.*, 48, 187 (1928); Neumann: *Z. Physik*, 45, 717 (1927); Goldhammer: 47, 671 (1928); 52, 708 (1929); Salessky: 52, 695 (1929).

<sup>19</sup> Pellat: *Ann. Chim. Phys.*, 18, 150 (1899); *J. Phys.*, (3) 9, 313 (1900).

decrease exponentially with time, this one would probably be a more complicated function of time because the resistance (or thickness) of the layers formed by the electrode products would be continuously changing as the electrolysis proceeded. In some cases the absorption current may have fewer components, since some of those mentioned may be negligible. The initial and final stages of the absorption current have some characteristics which require further interpretation.

The final stage of the decrease of the absorption current with time is sometimes extremely slow, and the anomalous discharge current may continue for several days or weeks. This may be explained by attributing to the most strongly adsorbed ions a very large time of relaxation after a disturbance of their equilibrium distribution by the applied electric field, but in some cases, particularly where the conductivity of the dielectric is high, it is undoubtedly largely due to the difference between the chemical composition of the anodic and cathodic products of electrolysis; that is, the dielectric with its electrodes acts as an accumulator, and the energy is stored in chemical differences rather than by electrostatic charges or dielectric polarization.<sup>20</sup>

The initial part of the absorption current has been investigated by measuring the current for very short times after the application of the voltage.<sup>21</sup> According to most investigators it does not approach a limiting value but continues to increase as the interval between the application of the voltage and the measurement of the current is shortened. Sinjelnikoff and Walther,<sup>21</sup> however, consider that the initial current can be extrapolated to zero time, the value obtained being the true conduction current. They attribute the decrease in initial current to the back-e.m.f. caused by the formation of a space charge in the dielectric. Of the several components of the absorption current discussed the only one which would be expected to yield an initial current which approaches a constant value corresponding to the true conduction current as the time between the application of the voltage and the measurement of the current is shortened is the one due to the formation of high resistance layers as a result of the electrode reactions accompanying the conduction current. This component of the absorption current would be practically zero until the electrolysis had continued long enough for the electrode reactions to produce an appreciable change in the resistance of some part of the dielectric. If all other components of the absorption current had sufficiently short relaxation times that they became reduced to zero before the conduction current had produced appreciable changes in the resistance of the dielectric, the initial current would remain sensibly constant until the effects of the electrode reactions on the resistance of the conduction paths became appreciable; this constant current is the true value of the conduction current. We have found that in cotton exposed to high humidities the

<sup>20</sup> Murphy: *J. Phys. Chem.*, 33, 509 (1929).

<sup>21</sup> Hopkinson: *Phil. Trans.*, 166, Part 2, 489 (1876); 167, 599 (1877); 189A, 109 (1897); Tank: *Ann. Physik*, (4) 48, 307 (1915); Whitehead and Marvin: *loc. cit.*, ref. 18; Goldhammer: *loc. cit.*, ref. 18; Salessky: *loc. cit.*, ref. 18; Sinjelnikoff and Walther: *loc. cit.*, ref. 1; Joffé: *loc. cit.*, ref. 1.

initial current in some cases remained sensibly constant for some time before commencing to decrease. Tank's measurements on paper, which behaves similarly to cotton electrically, showed that the initial current does not reach a constant value even for very short times. Our measurements on cotton indicated that the initial current at low humidities behaves differently from that at high humidities, and probably similarly to the initial current in paper as observed by Tank. These results may be interpreted to mean that the components of absorption due to adsorbed ions and to molecules predominate when the conductivity of the dielectric is low and the current is measured after short times, while the electrolytically produced component predominates when the conductivity is high, particularly in the latter stages of the absorption current. This is in agreement with the views expressed by Goldhammer that the processes accompanying the passage of a current through quartz are to be divided into two types, a rapid and a slow, the latter being electrolytic in nature and resulting in the formation of a high resistance layer at the anode, as previously observed by Warburg.<sup>22</sup> The more rapid type could be identified with the process of displacing the adsorbed ions on the surface of the structural units to which they are attached, and in fact Goldhammer<sup>22</sup> suggests a somewhat similar explanation.

*The Superposition Principle:* Hopkinson<sup>24</sup> found that, if a condenser which absorbs a residual charge is charged for some time and then the sign of the applied e.m.f. reversed for a shorter time, the first part of the discharge current corresponds in direction to the last charge imposed on the condenser but the direction of the discharge current becomes reversed at a later stage of the discharge and corresponds in direction to the first charge. This phenomenon is included under Hopkinson's law of the superposition of the effects of successively applied voltages. This behavior can be explained in terms of the mechanism proposed here by the difference in the relaxation times of different layers (or types) of adsorbed ions (cf. Fig. 2-B); the first part of the discharge current is that due to the layers of adsorbed ions of small relaxation time, the second to the layers of larger relaxation time for which the ionic distribution corresponding to the first charge was not completely effaced by the second charging. The discharge current in the external circuit would then be given by

$$i = A_1 e^{-t/T_1} + A_2 e^{-t/T_2} + \dots + A_{n-1} e^{-t/T_{n-1}} + A_n e^{-t/T_n}.$$

The sign of the charge on those elementary condensers whose first charge was not completely discharged because of their large time constant—those designated by the subscripts  $n, n-1, \dots$ —would be opposite to that on those of small time constant—those designated by subscripts  $1, 2, \dots$ , that is,  $A_n, A_{n-1} \dots$  would be negative when  $A_1, A_2 \dots$  are positive.

Another aspect of the superposition principle, stated by Curie<sup>25</sup> on the basis of measurements on many dielectrics, is that the constant final value

<sup>22</sup> Warburg and Tegetmayer: Wied. Ann. 41, 18 (1890).

<sup>23</sup> Goldhammer: loc. cit. ref. 18, p. 719.

<sup>24</sup> Hopkinson: loc. cit., ref. 21.

<sup>25</sup> Curie: Ann. Chim. Phys., (6) 18, 203 (1889).

of the charging current when added to the discharge current-time curve gives the charging current-time curve with sign reversed. This may be regarded as a superposition of the absorption current due to adsorbed ions and to molecules on the conduction current.

*Potential Distribution:* It has been experimentally shown that in some cases the absorption current changes the distribution of potential in a dielectric and in others not. For instance, Joffé<sup>26</sup> found that in calcite the absorption current is accompanied by the formation of a non-uniform potential gradient, almost the whole of the potential drop being concentrated in a very thin layer at one of the electrodes after the voltage had been applied for some hours. Von Seelen<sup>27</sup> and also Gingold<sup>28</sup> have found that for natural rock salt single crystals the same quantity of electricity was returned on discharging as went into the crystal on charging. In order to determine whether the absorption current was accompanied in this case by a back-e.m.f. concentrated in a thin layer at the electrodes, such as Joffé found for calcite, Gingold split the crystal into many sections after long charging and found that the polarization back-e.m.f. was uniformly distributed.<sup>29</sup> Gingold's interpretation of this is based upon Smekal's theory that conduction in crystals is confined to the lattice faults. The absence of any measurable conduction current would indicate that natural single crystals of rock salt at room temperature do not contain any faults which go the whole way through the crystal. He therefore attributes the absorption current to the movement of ions in short conducting paths and their accumulation at the ends of these paths. On the present hypothesis the absorption current in natural NaCl crystals may be explained as due to the displacement of ions on the surfaces of the crystallites of which the crystal is composed. This explanation is in agreement with Gingold's except that we substitute the adsorptive forces of the crystallites, which are presumably bounded by the lattice faults, for the "ends" of the short conducting paths.

In cotton, which is a dielectric whose conductivity is due to the water which it contains, and therefore conducts quite differently from rock salt or calcite, we have found that at high humidities the absorption current is accompanied by the production of a non-uniform potential gradient, the greater part of the potential drop being concentrated at one of the electrodes.<sup>4</sup> The change in potential distribution was found to depend on the electrode material and was shown to be due to a localized increase in the resistance of the dielectric because of electrolytically produced chemical changes. As the humidity was reduced this process became slower, and over a wide range of humidity (40-70%) the absorption current was negligibly small in comparison with the conduction current and the potential distribution was uniform after 0.5 minutes. At still lower humidities, however, the absorption cur-

<sup>26</sup> Joffé: *Ann. Physik*, (4) 72, 495 (1923).

<sup>27</sup> v. Seelen: *Z. Physik*, 29, 125 (1924).

<sup>28</sup> Gingold: *Z. Physik*, 50, 633 (1928).

<sup>29</sup> v. Seelen, working at a higher temperature, found that the potential distribution in NaCl crystals is independent of the time and direction of current flow.

rent again became prominent. Here the absorption current differed from that at high humidities in that, whereas at high humidities the resistance of the dielectric was practically unchanged by a reversal in the direction of the applied voltage, at low humidities the apparent resistance was changed by large amounts on reversal, and the decrease of the current with time at low humidities appeared to be entirely due to the back-e.m.f. due to the absorbed charge. Further, the increased apparent resistance at high humidities persisted long after the residual e.m.f. was negligible, while at low humidities it returned practically to the original resistance when the residual e.m.f. disappeared. On the present hypothesis this behavior indicates that at low humidities the free ions are present in such relatively small amounts that the displacement current due to the adsorbed ions predominates over the conduction current, while at high humidities the conductivity is so high that the displacement current due to adsorbed ions is negligible and the apparent absorption current is due to the resistance changes produced by the products of electrolysis, and the discharge current to an electro-chemically produced e.m.f. as mentioned above.

*Other Characteristics of Dielectric Absorption:* In addition to the properties which have been considered the most important in the discussion of dielectric absorption, namely, the form of the anomalous current-time curve, the superposition principle and the effect of the absorption current on potential gradient, the effects of voltage, temperature and exposure to ionizing radiations have been considered and are found to be not inconsistent with the mechanisms proposed to explain the other properties.

It has been found that the conductivity of most solid dielectrics increases with increasing applied voltage.<sup>30</sup> As mentioned previously this appears to be readily explained by the desorption of adsorbed ions. It would therefore be expected that the final value of the absorbed charge would increase less rapidly than the applied voltage. The results of Whitehead and Marvin,<sup>1</sup> showing that the absorbed charge falls off more rapidly on discharge the higher the charging voltage, may therefore probably be regarded as in agreement with the adsorbed ion mechanism. It is possible also that a quantitative relationship may exist between the change of conductivity with voltage and the change of absorbed charge with voltage.

Increase of temperature would have three effects; it would increase the total concentration of ions, but at the same time it would tend to cause the desorption of ions and therefore would result in an increase in the ratio of free to adsorbed ions but might either increase or decrease the total number of adsorbed ions; it would also increase the mobility of the ions. These effects permit consistent explanations of the data in the literature,<sup>31</sup> if assumptions are made on general grounds as to which effects predominate under different conditions.

<sup>30</sup> Evershed: *J. Inst. El. Eng.*, 52, 51 (1914); Poole: *Phil. Mag.*, 42, 488 (1921); Schiller: *Ann. Physik*, 81, 32 (1926); Smekal: *Z. techn. Physik*, 8, 561 (1927).

<sup>31</sup> Hopkinson: *loc. cit.*, ref. 21; Wagner: *loc. cit.*, ref. 18; Whitehead and Marvin: *loc. cit.*, ref. 1; Salessky: *loc. cit.*, ref. 18.

Irradiation in general causes an increase in the conductivity of a dielectric but apparently does not affect the absorbed charge.<sup>22</sup> Since there is evidence that the recombination of ions in solid dielectrics is a very slow process,<sup>23</sup> it would not be expected that irradiation would greatly affect a polarized distribution of adsorbed ions, particularly since the mobility of the adsorbed ions should be much less than that of free ions.

The conclusions from the above discussion of absorption may be summarized as follows:— It seems advantageous to recognize that dielectric absorption may have several components due to different mechanisms:—

*A<sub>1</sub>*, the absorption due to *free ions*.—The discharge of the ions at the electrodes results in chemical changes which, in some cases, produce high resistances in the conduction paths and therefore space charges in the dielectric. Space charges would also result from inhomogeneities already existing in the dielectric.

*A<sub>2</sub>*, the absorption due to *adsorbed ions*.—Elastic displacement or reversible changes in the distribution of ions adsorbed on inner surfaces under the influence of an applied electric field affords an explanation of many of the experimentally observed facts of dielectric absorption.

*A<sub>3</sub>*, absorption due to *molecules*.—If the dielectric contains some molecules with long relaxation times for the displacement of the charges within them or the orientation of the molecule as a whole in the electric field, a residual charge due to the molecules would result (cf. v. Schweidler); but the relaxation times connected with such processes would usually be expected to be very short.

The main characteristics of these several components of the absorption current are as follows: (1) With the exception of the free ion absorption due to electrolytically produced changes in the resistance of the dielectric, all of the components of the absorption current would probably decrease exponentially with time, but the values of the relaxation times would in general be different for each component. In the case of the component due to adsorbed ions each layer of ions may have a different relaxation time. The total absorption current is therefore in general the sum of several components which decrease exponentially with time and also one which probably does not. (2) Unless the inhomogeneities are uniformly distributed, the absorption current due to free ions is accompanied by the formation of a non-uniform potential gradient in the dielectric, indicating the presence of a space charge, while the absorption currents due to adsorbed ions and molecules are not accompanied by the formation of a space charge. (3) Where there is a component due to the electrolytically produced changes in the resistance of the dielectric the apparent absorption current would not in general obey the superposition principle quantitatively on account of the change in the resistance of the dielectric with time of application of the voltage.

The relative importance of the different components of the absorption current should depend on the nature of the material and the conditions. The

<sup>22</sup> Thornton: Proc. Phys. Soc., 22, 186 (1910); Neumann: loc. cit., ref. 18.

<sup>23</sup> Goldhammer: Z. Physik, 47, 671 (1928).

component due to electrolytically produced changes in the resistance of the dielectric is likely to predominate where the conductivity of the dielectric is high, either because of its high temperature, because of being exposed to a high humidity in moisture-absorbing materials, or because of the presence of many interstitial conduction paths in crystals. Further, the adsorbed ion type of dielectric absorption is likely to predominate in a given dielectric in the initial stage of the absorption current while the electrolytically produced type of absorption may be the effect predominating after the current has flowed for many minutes or hours.<sup>24</sup>

### Dielectric Loss

In the most general terms dielectric loss is the electrical energy converted into heat when an alternating voltage is applied to a material classified as a dielectric. It is given by  $E^2G$  or  $I^2R$ , where  $E$  is the r.m.s. value of the applied alternating voltage,  $G$  is the equivalent parallel conductance,  $I$  the r.m.s. value of the current, and  $R$  the equivalent series resistance. Part of this loss is due to the Joule heat corresponding to the direct current conductance but this part of the loss is usually negligible. That there is a component of dielectric loss not directly due to the direct current conductance has been inferred from the fact that the equivalent parallel conductance of a dielectric for alternating current is considerably greater than the direct current conductance. Some uncertainty is connected with the magnitude of the difference between these two conductances since the d.c. conductance in general depends on the time of application of the measuring voltage.

It has been shown theoretically<sup>25</sup> that dielectrics which show absorption, i.e., a residual charge, in constant electric fields must also dissipate electrical energy as heat when an alternating voltage is applied. In some cases, moreover, it has been demonstrated experimentally that practically the whole dielectric loss is due to absorption<sup>26</sup> and in other cases to d.c. conduction. Dielectric loss would therefore be expected to be at least as complex as dielectric absorption if not more so. On the basis of the interstitial mechanism of conduction and absorption which has been described, dielectric loss would be expected to be divisible into the following main components:

$L_1$ , that due to free ions;

$L_2$ , that due to adsorbed ions;

$L_3$ , that due to the dielectric polarization of the molecules; this would exist even if there were no ions in the dielectric.

*Free Ion Dielectric Loss:* This includes, of course, the Joule heat due to direct current conduction. In fact, Sinjelnikoff and Walther<sup>27</sup> and Joffé<sup>27</sup>

<sup>24</sup> The interpretation given by Goldhammer (ref. 18) of his experiments on the conductivity of quartz is similar to this in indicating that there are two processes, one rapid and the other slow, and that the back e.m.f. of polarization is not due to space charges in the initial stages.

<sup>25</sup> Schweidler: loc. cit., ref. 18.

<sup>26</sup> Tank: loc. cit., ref. 21.

<sup>27</sup> Sinjelnikoff and Walther: loc. cit., ref. 1; Joffé: Ann. Physik, 48, 288 (1928).

state that they have found that if the direct current conductance is properly measured it explains all the dielectric loss, except that obviously due to inhomogeneity of the dielectric according to the Maxwell-Wagner theory. This conclusion has been adversely criticized by Schiller<sup>38</sup> and by Smekal.<sup>39</sup> The results of Sinjelnikoff and Walther may well be a special case and not of such general applicability as they suggest. For instance, we have found that in cotton at low frequencies and high moisture contents the dielectric loss is completely accounted for by the d.c. conductivity when the latter is so measured that the error due to changes in resistance produced by the electrode reactions is avoided; but we find that at humidities below 75% the dielectric loss cannot be accounted for in this way.<sup>40</sup>

In addition to providing a constant conduction current with its attendant I<sup>2</sup>R heat loss, free ions are able to produce dielectric loss in other ways. For instance, if the resistance of the conduction path is non-uniform, as when there is a high resistance at one or both of the electrodes, the conduction path instead of being a pure resistance becomes equivalent to a resistance in series with a condenser, and the a.c. conductance is therefore greater than the d.c. conductance. The non-uniformity in the resistance of the conduction paths may be due to high contact resistances at the electrodes or to the chemical products of the electrolysis associated with ionic conduction. In dielectrics, such as textiles, paper, etc., whose conductivity is due practically entirely to the moisture which they contain, the free ions may contribute to dielectric loss also through losses associated with the electrolytic polarization capacity of the conduction paths. This is a quantity which has been studied independently in conducting solutions and is very large in some cases. It appears to be largely due to concentration differences and relatively high resistances at the electrodes.<sup>41</sup>

The Debye-Falkenhagen theory of the dispersion of conductivity and dielectric constant of electrolytic solutions<sup>42</sup> also indicates that free ions such as exist in the conducting paths in moisture absorbing dielectrics should behave to some extent like a dielectric, owing to the "ionic atmosphere" which surrounds each ion. That is, the free ions carry not only a non-condensive conduction current but also to a small extent a complex current with a displacement current component and a conduction current component, both dependent on frequency, because of the formation of these ionic atmospheres.

It is to be concluded therefore that, particularly in dielectrics whose conductivity is due mainly to moisture, free ions can contribute to dielectric loss in several ways: by the constant direct current conductance which they produce; by the interactions between free ions (Debye-Falkenhagen effect); by the polarization capacity generally involved in electrolytic conduction,

<sup>38</sup> Schiller: *loc. cit.*, ref. 1.

<sup>39</sup> Smekal: *Z. techn. Physik*, 8, 561 (1927).

<sup>40</sup> Murphy: *J. Phys. Chem.*, 33, 200 (1929). See Fig. 4.

<sup>41</sup> Banerji: *Trans. Faraday Soc.*, 22, 111 (1926).

<sup>42</sup> Debye and Falkenhagen: *Physik. Z.*, 29, 121 (1928); Sack: 29, 627 (1928); Zahn: *Z. Physik*, 51, 351 (1928).



at least in solutions; and by the prior existence, or production by the current, of non-uniformity in the resistance of the conduction paths. All of these factors except the first produce an equivalent parallel conductance and capacity which varies with frequency in a somewhat similar general manner to the variations in equivalent parallel conductance and capacity observed in dielectrics.

*Dielectric Loss due to Adsorbed Ions:* The way in which adsorbed ions could contribute to dielectric loss is readily evident from Fig. 1-B, and from the circuit of Fig. 2-B, which was shown in connection with dielectric absorption to represent the electrical effect of the redistribution of ions on the surface of the structural unit by which they are adsorbed. When an alternating voltage is applied to such a system, the adsorbed ions will move back and forth on the surface of the structural unit to which they are attached; the motion of these ions contributes to the alternating current conductance and capacity but not to the direct current conductance. It would be expected that the dielectric loss associated with this polarization of the ions adsorbed on the surface of a micelle or a crystallite would be greater than that associated with the polarization of a molecule because adsorbed ions probably share in the thermal motion as individuals, whereas the opposite charges of a molecule move as a whole in regard to thermal motion.

The electrical effects of the adsorbed ions can most readily be seen from the equivalent circuit of Fig. 2-B. As pointed out in the discussion of dielectric absorption, the elements of this circuit are equivalent to the molecules having different time constants in von Schweidler's theory, which can therefore be applied without modification to adsorbed ion dielectric loss in accordance with the mechanism proposed here.

*Molecular Dielectric Loss:* The types of dielectric loss so far discussed depend upon the existence of ions, either free or adsorbed, in the dielectric. But electrical energy can be transmitted through a dielectric as a displacement current even if it contains no ions, the energy being transmitted from molecule to molecule through the dielectric by means of the forces due to the electric polarization of the molecules. These electrical forces would tend to produce mechanical displacements of the molecules which would in general be accompanied by some loss of energy as heat due to damping. The outstanding theory which involves what may be called molecular dielectric loss is Debye's<sup>48</sup> dipole theory, which has proved to be a valuable means of investigating the structure of molecules. According to this theory the molecules of some dielectrics have permanent electric moments and the orientation of these dipoles in the gaseous or dissolved state by an electric field contributes to the dielectric polarization and is also accompanied by the absorption of electrical energy as heat. Debye has shown that with certain simplifying assumptions the frequency at which the absorption is a maximum may be calculated from the physical constants of dielectrics with qualitative agreement with experiment.

<sup>48</sup> Debye: Verh. deutsch. physik. Ges., 15, 777 (1913).

*Discussion:* The main facts regarding dielectric loss which must be explained by any proposed mechanism are the form of the dielectric loss-frequency curve, the apparent capacity-frequency curve, the loss angle-frequency curve, and the effect of temperature and voltage on these curves. With the exception of the Joule heat loss, all of the mechanisms involved in the components of dielectric loss discussed in the preceding paragraphs can be approximately represented by somewhat similar systems of resistances in series and parallel with capacities, and they should therefore all be characterized by approximately the same general type of variation of capacity, dielectric loss and loss angle with frequency. The existence of these several components of dielectric loss described above provides an alternative physical interpretation of the several characteristic time constants introduced in the Maxwell-Wagner theory of dielectric absorption and loss to account for the experimental facts and attributed by Wagner<sup>44</sup> to the presence of several different types of impurities in the dielectric.

The application of the ideas developed above to the behavior of typical commercial dielectrics will serve to illustrate the advantages of recognizing the complex nature of dielectric loss and particularly the contribution of the adsorbed ions. It has been found that dielectric loss in cotton is greater the greater the salt content of the cotton.<sup>45</sup> This was found to be true not only of the range of humidities where the dielectric loss was shown to be almost entirely due to d.c. conduction but also in the range where it was demonstrated not to be due to d.c. conduction. In the latter range of humidity the potential gradient was also unchanged even by an application of a direct voltage for some minutes. These observations can readily be interpreted in terms of the adsorbed ion hypothesis, since the adsorption of the ions by the cellulose micelles would increase with the total number of ions available and the dielectric loss due to adsorbed ions would therefore be greater the greater the salt content of the cotton.

As another example we may consider the behavior of such substances as rubber and beeswax. Wagner<sup>46</sup> found for these substances that the loss angle when plotted as a function of temperature has a maximum, and that this maximum is displaced toward higher temperatures by increasing the frequency. Curtis and collaborators<sup>47</sup> have also found that on increasing the sulphur content in rubber both the power factor and the capacity at first increase, reach a maximum and then decrease while at the same time the hardness, density, and d.c. resistivity increase continuously. Kitchen<sup>48</sup> found that the maxima are displaced to lower sulphur contents the higher the frequency. Since both a decrease in sulphur content and an increase in temperature cause an increase in softness in rubber, this is analogous to the behavior found by Wagner with respect to the variation of power factor with

<sup>44</sup> K. W. Wagner: *Arch. Elektrotech.*, 2, 371 (1914); 3, 67 (1914).

<sup>45</sup> Murphy: *loc. cit.*, ref. 40. Fig. 4.

<sup>46</sup> K. W. Wagner: *loc. cit.*, refs. 1 and 44.

<sup>47</sup> Curtis, McPherson and Scott: *Sci. Papers, Bur. of Standards*, 22, No. 560 (1927).

<sup>48</sup> Kitchen: *loc. cit.*, ref. 1.

temperature. Kitchen proposed an explanation of this in terms of the Debye dipole theory; but, since rubber, owing to its colloidal structure, is a material in which the effects of adsorbed ions ought to be particularly prominent, it appears worth while to attempt an alternative explanation of this phenomenon in terms of the adsorbed ion hypothesis. The fact that for the first increments of sulphur the capacity increases while the d.c. conductivity decreases, suggests that the ions which take part in d.c. conduction at lower sulphur contents become adsorbed as the sulphur content is increased because of an increase in the strength of the adsorptive forces—which may perhaps be inferred from the increase in hardness. This would have three effects. It would tend to increase the component of capacity due to adsorbed ions because of the increase in their number, but at the same time it would tend to decrease it by reducing the polarizability of the adsorbed ions, because the amount of displacement of the adsorbed ions produced by a given electric field would decrease as the strength of the adsorption forces increases. Further, in accordance with previous assumptions, it would tend to increase the frictional resistance to displacement of the adsorbed ions by the electric field.

In accordance with previous considerations it will be assumed that the unit of the physical mechanism of conduction in rubber, i.e., the elements of structure (micelles) with their adsorbed ions, is equivalent electrically to the circuit of Fig. 2-B. The equivalent parallel capacity of this circuit is

$$C = C_m + \frac{C_1}{1 + (R_1 C_1 \omega)^2} + \dots + \frac{C_n}{1 + (R_n C_n \omega)^2} \quad (1)$$

the equivalent parallel conductance

$$G = \frac{1}{R_{d.c.}} + \frac{R_1 (C_1 \omega)^2}{1 + (R_1 C_1 \omega)^2} + \dots + \frac{R_n (C_n \omega)^2}{1 + (R_n C_n \omega)^2} \quad (2)$$

and the power factor,

$$\frac{G}{G + jC\omega} = \frac{\frac{1}{R_{d.c.}} + \frac{R_1 (C_1 \omega)^2}{1 + (R_1 C_1 \omega)^2} + \dots}{\left[ \frac{1}{R_{d.c.}} + \frac{R_1 (C_1 \omega)^2}{1 + (R_1 C_1 \omega)^2} + \dots \right] + j\omega \left[ C_m + \frac{C_1}{1 + (R_1 C_1 \omega)^2} + \dots \right]} \quad (3)$$

$\omega = 2\pi \times$  frequency;  $j = \sqrt{-1}$ ;  $C_1, \dots, C_n$  and  $R_1, \dots, R_n$  have the same significance as in Fig. 2-B. In the remainder of the discussion only one layer of adsorbed ions will be considered for convenience.

As the sulphur content increases  $R_1$  and  $C_1$  increase, and the relaxation time  $R_1 C_1$  therefore also increases. Equation (1) shows that while  $(R_1 C_1 \omega)^2$  is less than 1, increasing the sulphur content causes  $C$  to increase but when  $(R_1 C_1 \omega)^2$  becomes larger than 1,  $C$  decreases with increasing sulphur content, thus explaining the maximum in the capacity-composition curve. A further influence tending to cause this maximum is the decrease in the polarizability of the adsorbed ions with increasing strength of the adsorptive forces. Equation (1) also shows that the maximum will occur at a smaller relaxation time (i.e., sulphur content) the higher the frequency.

The effect of changes in sulphur content on the power factor is evident from equation (3). In this equation, since rubber is a good insulator,  $1/Rd.c.$  is negligible in comparison with the second term in the numerator except where the conductivity is high, as at high temperatures. The imaginary term is the larger of the two terms in brackets in the denominator since the observed power factors are only a few percent. The power factor is therefore approximately

$$\frac{R_1 C_1^2 \omega}{1 + (R_1 C_1 \omega)^2} \cdot \frac{1}{C_m + \frac{C_1}{1 + (R_1 C_1 \omega)^2}} \quad (4)$$

Since  $R_1 C_1$  increases with increasing sulphur content, the power factor increases with increasing sulphur content when  $(R_1 C_1 \omega)^2$  is less than 1, but decreases with increasing sulphur content when  $(R_1 C_1 \omega)^2$  is greater than 1. As in the case of the capacity the maximum is displaced toward lower sulphur contents by an increase in frequency.

The variation of power factor with frequency is also evident from equations (3) or (4). Where  $(R_1 C_1 \omega)^2$  is less than 1 the power factor increases approximately in direct proportion to the frequency, but passes through a maximum, and for very high frequencies is approximately inversely proportional to the frequency. The variation of equivalent parallel capacity with frequency is given by equation (1). For low frequencies the capacity is  $C_m + C_1$ , but it decreases with increasing frequency, becoming  $C_m$  for large values of  $\omega$ . That is, at high frequencies the capacity term due to adsorbed ions, or similar processes involving long relaxation times, becomes zero and only the capacity due to the polarization of the charges within the molecules is left.

The main characteristics of the variation of power factor and capacity with frequency, temperature and sulphur content (in rubber) appear to be consistently explained by a mechanism electrically equivalent to the circuit of Fig. 2-B. However, the Debye dipole theory and also the Maxwell-Wagner theory of dielectric absorption lead to equations which yield types of variation of capacity and power factor with frequency which are very similar to those derived above. Results similar to the above could therefore probably also be obtained by assuming that adsorbed ions are equivalent in some of their electrical effects to the dipoles of the Debye theory.\* An advantage of the adsorbed ion explanation is in explaining the increase of capacity with increasing sulphur content. This was explained by Kitchen as due to an increase in the average dipole moment by the formation of unsymmetrical sulphur-rubber compounds. A distinction between this mechanism and the adsorbed ion mechanism could perhaps be made by investigation of the effects

\* In the theory of dielectric polarization three types of polarization are recognized (L. Ebert: *Z. physik Chem.*, 113, 1 (1924)),  $P_e$  the displacement of the electrons within the molecule,  $P_a$  the displacement of the atoms within the molecule,  $P_o$  the orientation of the molecule as a whole where it has an electric moment. The present suggestion essentially amounts to adding a fourth type of polarization  $P_i$ , the polarization due to adsorbed, or similarly bound ions.

of voltage, for the adsorbed ions should be desorbed with increasing voltage with a consequent increase in d.c. conductivity and possibly also other measurable effects.

While the mechanisms developed for explaining dielectric loss in solid dielectrics are not directly applicable to liquid dielectrics, there appear to be reasons for expecting an analogous mechanism whereby the ions in a liquid dielectric can contribute to the a.c. conductivity but not to the d.c. conductivity. The process in liquids which is most nearly analogous to the adsorption of ions in solids is the association of ions with neutral molecules (e.g., solvation). Both in liquids and in gases<sup>49</sup> studies of ionic mobilities indicate that it is probable that the ions condense neutral molecules around them and become fairly large aggregates. The effect of this is only to reduce the mobility of the ion and hence reduce the d.c. conductivity, for unlike the similar process in solids, the neutral particles to which the ions are attached are free to move under the influence of an electric field. But if both positive and negative ions have neutral molecules condensed around them, and if the concentration of ions in the liquid is determined by a kinetic equilibrium between the processes of ionization and recombination, it appears probable that oppositely charged aggregates would tend to become associated and thus form a dipole; for the oppositely charged ions would exert an attraction upon each other but would be prevented from combining by the neutral molecules of the aggregates of which they form the nuclei. Such aggregates might be fairly stable because their formation would probably involve a decrease of potential energy. They would form "ionic dipoles" of molecular dimensions or larger, and would differ from molecular dipoles in that their number would depend on the concentration of ions in the liquid. It is possible that the effects of this type of dipole could explain some of the electrical properties of liquid dielectrics. Dipoles of this kind might contribute to the explanation of the relationships between d.c. conductivity and dielectric loss, and would also be expected to be readily separated into their constituent ions by an increase in voltage. Consequently, the conductivity would increase with increasing voltage because of the transformation of some of the dipoles into free ions which would accompany the increase in voltage. Wien found such an increase of conductivity with voltage in electrolytes.<sup>50</sup>

Gyemant<sup>50</sup> has observed a further effect in high-resistance liquid dielectrics which lends itself to ready explanation in these terms. He found that while the conductivity of certain high resistance liquid dielectrics increases with increasing field strength in the direction of the field, it is unaffected in the direction normal to the field. This observation may be readily explained in accordance with the above mechanism and may be regarded as contributory evidence in favor of the role of adsorbed or associated ions in conduction phenomena in liquids. As already stated, there is evidence that

<sup>49</sup> Loeb: *Phys. Rev.*, (2) 32, 81 (1928).

<sup>50</sup> Wien: *Ann. Physik*, (A) 83, 327 (1927); Joos and Blumentritt: *Physik. Z.*, 28, 836 (1927); Gyemant: 29, 289 (1928); Joos: 29, 570 (1928).

in some cases liquids may be associated into aggregates which may be regarded as ionic dipoles and which could adsorb ions. These ionic dipoles with their adsorbed ions would differ from the free ions in that they would not give the medium an isotropic conductivity for two fields of different strengths, applied at right angles to each other, but would become oriented in the field and the adsorbed or associated ions would be liberated in larger numbers in the direction of the larger field than in the direction of the smaller field. This is very similar to the explanation of the phenomenon proposed by Gyemant who assumed the presence of pairs of associated ions which are neither chemically united nor free. Since it is generally recognized that association is present in liquids and that ions form effective centers for association and that aggregates containing as many as  $10^5$  molecules are of frequent occurrence it is probable that the dipoles resulting from the association of ionic aggregates of opposite sign may frequently be factors in determining the dielectric behavior of liquids.

The above discussion of dielectric loss may be summarized as follows: It has been shown that dielectric loss may involve in some cases three independent mechanisms. Debye has shown that there is a certain dielectric loss associated with molecular polarization. It is evident that the molecular dielectric loss is not dependent upon the presence of ions of any kind and therefore this theory could not be applied to a material unless correction were first made for the ionic dielectric loss. A correction based on the d.c. conductivity may be insufficient since this takes account only of the free ions. Whether the molecular dielectric loss or the ionic dielectric loss predominates in any material will depend not only on the material itself but also on the temperature, voltage and frequency of the measurement. If it proves feasible to separate dielectric loss into its components they may each in turn be correlated with other physical properties which can be independently measured. Molecular dielectric loss may be correlated with viscosity in liquids, as has been done for example in Kitchen's<sup>51</sup> work on rosin oil and castor oil, and in solids perhaps with such properties as the cohesion and thermal conductivity, so that in this way the dielectric loss may perhaps become as useful an indication of the structure of solids and liquids as the dielectric constant is of molecular structure. The adsorbed-ion dielectric loss, on the other hand, may be associated with the dimensions of structural aggregates containing many molecules, with the influences tending to cause ionization, and with the phenomena of adsorption. The free-ion dielectric loss may in some cases be related to the properties of electrolytic solutions, such as polarization capacity and direct current conduction. It seems necessary to relate dielectric loss to other independently measurable physical properties in order to distinguish between the possible physical mechanisms which yield a similar type of variation of power factor and capacity with frequency, temperature, etc. This division indicates that the apparent successes of both molecular and ionic theories of dielectric loss may not be contradictory, but due to

<sup>51</sup> Kitchen: loc. cit., ref. 1.

experimental conditions being such that molecular dielectric loss is being studied in the one case and ionic dielectric loss in the other; low conductivities, low temperatures, low humidities, and high frequencies would favor the first mentioned condition and the opposite the second condition.

#### Summary

In most solid dielectrics direct-current conduction appears to take place not uniformly through the material, but through a system of conduction paths of sub-microscopic dimensions dispersed in the insulating medium in a manner related fundamentally to the structure of the material. This conclusion is chiefly based upon Smekal's investigations of crystalline dielectrics and our own results for textiles. Smekal shows that crystalline dielectrics are composed of ideally-formed structural units, between which they are imperfectly formed regions which have a higher conductivity than the ideal parts of the lattice. In materials such as cotton, conduction takes place through water which is probably condensed in the interstices between the cellulose micelles. An important property of such "interstitial conduction" systems is that ions would undoubtedly be adsorbed by the interface between the insulating units and the relatively conducting interstitial medium, and since the interfacial area would be large as compared with the volume of such conduction paths, the influence of these adsorbed ions on the electrical properties of the dielectric would be expected to be very important in some cases. The ions may be regarded as free to move over the surface of the particular structural unit by which they are adsorbed but not to migrate to adjacent structural units. The application of an electric field produces a polarized distribution of the ions adsorbed on the surface of each structural unit and the ions return to their normal distribution after the removal of the electric field. The electrical effect of the adsorbed ions is therefore similar to that of a dipole, and they produce a kind of "dielectric" polarization.

According to this picture of the structure of a dielectric, free ions, adsorbed ions, and neutral molecules may each contribute to the total dielectric absorption (residual charge) and dielectric loss, and the relative prominence of each of these components should depend on the type of dielectric, the temperature and other factors. The characteristics of dielectric absorption and loss are discussed from the point of view of this division.

The form of the absorption current-time curve can be explained by the following considerations: (a) If the structural units of the dielectric are surrounded by an atmosphere of adsorbed ions which diminishes in density with distance from the interface, each layer of ions can be regarded as having a different time of relaxation for the polarized distribution produced by an electric field. The sum of the absorption currents due to several layers of ions, as well as those due to inhomogeneity in the resistance of the dielectric, could give the observed curves. (b) The latter stages of the absorption current are probably due to the electrode reactions which accompany free ion conduction.

The superposition principle can readily be given a physical interpretation if it is assumed that dielectrics contain ions adsorbed with degrees of intensity ranging over wide limits, the relaxation time of the ions increasing with the strength of the adsorption.

The important fact that in some cases dielectric absorption is accompanied by the formation of a space charge and non-uniform potential distribution and in others not can be explained if the absorption in the first case is due to free ions and in the second to adsorbed ions. For the residual charge due to adsorbed ions, according to the present mechanism, does not produce a space charge or non-uniform potential gradient, while that due to free ions does.

Several different ways in which free ions may produce dielectric losses are discussed. The ways in which adsorbed ions and neutral molecules contribute to dielectric loss are also discussed.

The existence of layers of adsorbed ions with different relaxation times provides a new physical interpretation of von Schweidler's theory of dielectric absorption and loss wherein he attributes to the molecules a wide range of relaxation times. The presence of components of dielectric loss due to free ions, to adsorbed ions and to molecules, each component varying with frequency in a somewhat different way, provides an alternative physical interpretation of the characteristic time constants which Wagner attributed to different types of impurities.

The observation that dielectric loss in cotton is very sensitive to changes in the amount of water-soluble salts in the material even at humidities where the dielectric loss was shown not to be due to direct current conduction may be interpreted as a strong evidence of the existence of dielectric loss due to adsorbed ions.

An attempt is made to explain variations in power factor and dielectric constant in rubber with changes in sulphur content on the adsorbed ion hypothesis.

In liquid dielectrics ion of opposite sign which have neutral molecules condensed around them may become associated to form "ionic dipoles," whose electrical effects may be somewhat similar to those of adsorbed ions in solids.

An important property of adsorbed ions in solids or ionic dipoles in liquids is that as the strength of the applied field is increased adsorbed ions should become "desorbed" and ionic dipoles separated into their constituent ions. This affords the possibility of relating the changes in the conductivity of dielectrics with voltage to other electrical properties such as absorption.

*Bell Telephone Laboratories,  
New York, N. Y.*



## THE SURFACE ENERGY OF SOLIDS I

### Surface Energy of BaSO<sub>4</sub>

BY B. BRUZS

The equation of the Phase Rule

$$F = C - P + 2 \quad (1)$$

is restricted to systems of three degrees of variance (P,V,T). As soon as a new degree of variance is considered the last member of the above equation must be increased by one. Every two-phase system has a boundary between the two phases which is the seat of surface energy. The latter varies with the extension and character of the interface. Consequently a system for example of one component (C) in two phases (P) has one degree of variance (F) only when the interface is defined, in other words when the surface energy has a fixed value.

It is customary to neglect the definition of the surface of a system and still to consider equation (1) correct in all cases when the interface is small. This is due to the fact that the intensity factor ( $\sigma$ ) of the surface energy—the surface tension—is so small for all investigated systems (it is for liquids on the average about 100 ergs/cm<sup>2</sup>) that the surface energy  $\sigma o$  remains negligible unless the surface ( $o$ ) assumes very large values. For a particle size as fine as 1  $\mu$  O is about 10<sup>6</sup> cm.<sup>2</sup> and the total surface energy approximately 2 cal./mole. When the interface assumes very large values (particle size below 1  $\mu$ ) we call the resulting systems colloidal or disperse and treat them with special consideration of the surface energy phenomena. It is clear however that the neglect of surface energy in all common cases is justified only under the assumption that for all substances in all states of aggregation  $\sigma$  remains below about 10<sup>3</sup> ergs/cm.<sup>2</sup> Unfortunately in the case of solids, which present special difficulties to the determination of their surface tension,<sup>1</sup> we are confined to indirect methods and have as yet very uncertain information. The indirect methods of determination of  $\sigma$  are:

1. Theoretical determination with the aid of lattice theories. According to Born and Stern<sup>2</sup> for a NaCl lattice:

$$\sigma = 0.933 \frac{e^2}{r^3} = \frac{4030}{V} \quad (2)$$

where  $e$  is the elementary charge and  $V$  the molecular volume. The assumptions involved in the derivation permit of an approximate calculation only.

2. Calorimetric determination of the surface energy and calculation of  $\sigma$  from parallel surface determination is a very promising method but has

<sup>1</sup> Wien-Harms: Handbuch der Experimentalphysik, 6, 255 (1928); Antonoff: Nature, 121, 93 (1928); Arzybishev: Z. Physik, 48, 286 (1928).

<sup>2</sup> Wien-Harms: 268 (1928). Handbuch der Experimentalphysik, 6, 268; 7, 412 (1928).

as yet been used very seldom. Lipsett Johnson and Maass<sup>1</sup> determined the surface tension of NaCl from the difference in the heat of solution of NaCl in different states of subdivision. They obtain a value of 386 ergs/cm.<sup>2</sup>

3. Determination of  $\sigma$  from measurements of vapour pressure change ( $\Delta P$ ) with grain size (radius  $r$ ) by application of Thomson's formula:

$$\sigma = \frac{\rho r}{2m} RT \Delta \ln P$$

is fairly unsafe on account of experimental difficulties and many assumptions involved in the derivation of the formula. Centnerszwer and Krustinsons<sup>3</sup> find by this method surface tensions for different solids of the order of magnitude of  $10^4$  to  $10^5$  ergs/cm. These values which give for a powder of  $1\mu$  grain size surface energies above 1000 cal/mole are exceptionally high and at any rate indicate the urgent necessity of more reliable material on the surface tensions of solids. Regarding the high values obtained by Centnerszwer and Krustinsons we want to suggest the following explanation. Apart from the faults inherent in the derivation of the Thomson formula<sup>2</sup> we want to stress a special point concerning its application to crystals. First of all surface tension must change with different density of the lattice elements on different surfaces and further on it can be expected that on account of the special position of edges and corners (small radius of curvature) the surface energy will be concentrated on these spots in close analogy to static electricity. Since kinetic measurements on solid-gas reactions<sup>4</sup> indicate that the vapour pressure is connected primarily with the edges and corners of the solid phase we suggest that for  $r$  in equation (3) one should use a value much smaller than the one obtained from microscopic determination. The high values of Centnerszwer and Krustinsons represent in this case the surface tension of the edges and corners. The vectorial characteristics of surface energy in connection with their manifestation in heterogeneous kinetics might have a special significance for problems of colloid chemistry. With decreasing grain size we obtain systems with increasing vapour pressure, i.e. with increasing free energy. Consequently all colloidal systems are unstable and represent solely stationary states. These states are subject to two kinetic phenomena: the number of nuclei increases (grain size decreases) with increasing concentration of the reagents, the heat of activation, which governs the velocity of recrystallization, increases with grain size. The final equilibrium for all systems will be attained when the grain size will be at a maximum, but for stationary states (limited time) we find that the grain size has a maximum for certain concentrations.<sup>5</sup>

The aim of the present investigation was the determination of surface energies by the calorimetric method. We made use of the above-mentioned

<sup>1</sup> J. Am. Chem. Soc., 49, 925, 1940 (1927); 50, 2701 (1928).

<sup>2</sup> Z. physik. Chem., 130 (Cohen Festband), 187 (1927), 132, 185 (1928).

<sup>3</sup> Bigelow and Trimble: J. Phys. Chem., 31, 1798 (1927).

<sup>4</sup> Bruzz: Z. physik. Chem., B3, 427 (1929).

<sup>5</sup> P. P. von Weimarn: "Zur Lehre von den Zuständen der Materie" (1914).

fact that, beginning with a certain concentration of the reagents, the grain size of the precipitate in a metathesis reaction decreases with concentration and we expected to find continually decreasing heats of formation on account of the smaller stability of the precipitates of small grain size.

**Scheme of the Reaction for the Determination of the  
Surface Energy of BaSO<sub>4</sub>**

The following set of reactions was selected:

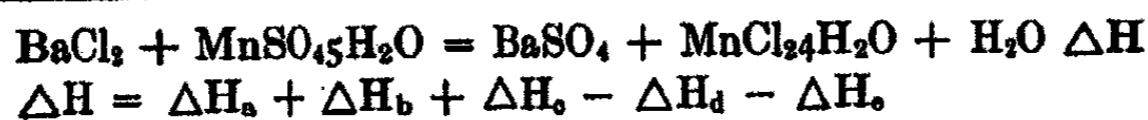
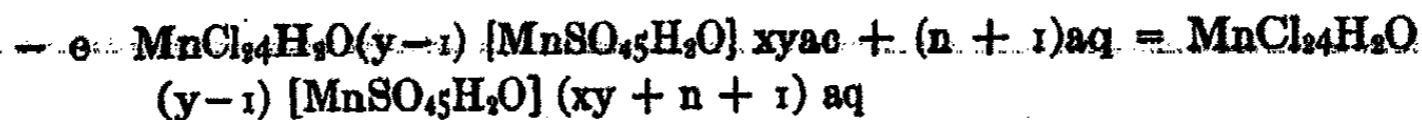
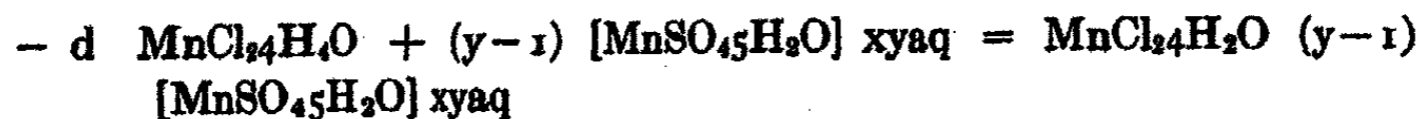
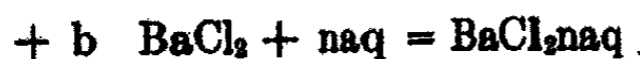
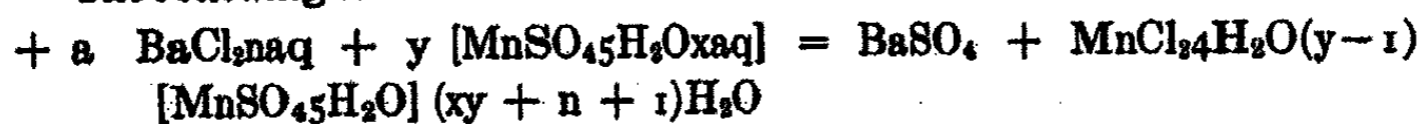

$\Delta H_a$  is the heat of the metathesis reaction.  $\Delta H_b$  is the integral heat of solution of BaCl<sub>2</sub> and is constant for all reactions conducted.  $\Delta H_c$  and  $\Delta H_d$  are differential heats of solution of MnSO<sub>4</sub>·5H<sub>2</sub>O and MnCl<sub>2</sub>·4H<sub>2</sub>O resp. in a solution of MnSO<sub>4</sub> and finally  $\Delta H_e$  is the heat of dilution of the resulting solution of MnCl<sub>2</sub> in MnSO<sub>4</sub> by the water of the disappearing BaCl<sub>2</sub> solution. Considering that  $x \cong 18 \div 55$   $n \cong 300$  and  $y \cong 500 \div 50$  one easily sees that  $\Delta H_e$  plays the role of a second order correction factor only and can consequently be neglected in the calculation. The resulting  $\Delta H = \Delta H_a + \Delta H_c - \Delta H_d + \text{const}$  should be a constant independent of the concentration of the reagents if the energy content of BaSO<sub>4</sub> is independent of the conditions of precipitation. On the other hand a change in the value of  $\Delta H$  would represent the change in surface energy. The experimental procedure adopted was the following:

1. Electrical calibration of the calorimeter containing about 100 cm<sup>3</sup>. of an m molar MnSO<sub>4</sub> solution to which about 4 gr MnCl<sub>2</sub>·4H<sub>2</sub>O were initially added.

2. Determination of  $\Delta H_b$  by introduction of approximately 1 gr. of pure recrystallized MnSO<sub>4</sub>·5H<sub>2</sub>O (one and the same material throughout).

3. Determination of  $\Delta H_d$  by introduction of approximately 1 gr of MnCl<sub>2</sub>·4H<sub>2</sub>O (one and the same material throughout).

4. Determination of  $\Delta H_a$  by introduction of approximately 1.5 cm<sup>3</sup>. of a 0.2 molar solution of BaCl<sub>2</sub>.

## Apparatus

The differential calorimeter used is shown schematically on Fig. 1. The calorimeter is made of Durang glass. A battery of 700 thermoelements Cu-Constantan (0.1 mm) (A) divides the calorimeter in two equivalent parts. The thermoelements are isolated by rubber strips and the battery is imbedded in shellack. The surface is polished and the ends of the thermoelements are covered with a thin layer of Durofix entirely waterproof and

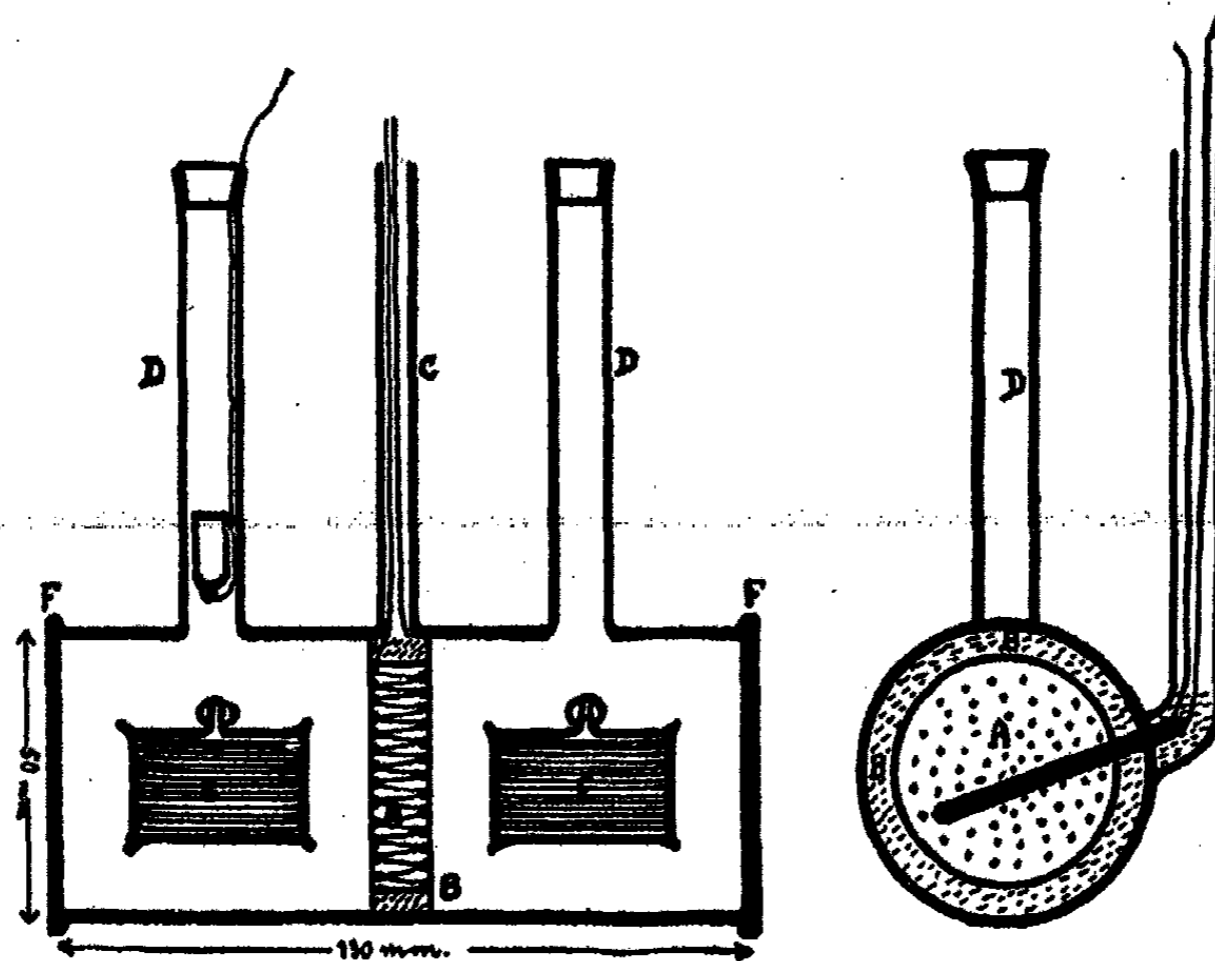

FIG. 1

isolating. With the aid of a cork rim B the battery is tightly placed in the middle of the cylinder and made air tight along the boundaries of the cork by Picein. The terminals of the battery lead through a glass piece C to a Hartmann and Braun galvanometer. D serves for introduction of the substance and E is a calibrating heater of 0.2 mm Constantan enamelled wire bifilarly wound on a quadrangular glass support. Its resistance is 109.7 $\Omega$ . The ground ends of the cylinder are closed by glass windows F attached with Picein. The calorimeter was put into a shaking apparatus constructed for this purpose.

The change in temperature caused by current or reaction was read off every half minute and evaluated by the usual graphic methods.

Surface Energy of BaSO<sub>4</sub>

Table I gives the results of the first determinations.

The last column shows that with increase in concentration of the MnSO<sub>4</sub> solution from 1 molar to 3 molar the surface energy of BaSO<sub>4</sub> increases by as much as 2,200 cal/mole. This effect is about 18 times larger than the caloric effect obtained by Lipsett, Johnson and Maass for NaCl and will

TABLE I

a	b	c	d	e	f	g	h
1.0	128.2	52.0	1.032	0.81	+ 2.0	-500	0.96
	128.8	53.0		0.80	+ 2.0	-510	1.12
1.5	130.0	54.0	1.030	0.94	- 3.0	650	1.13
	130.0	54.0					
2.0	129.8	55.0	1.011	0.93	- 9.0	1940	1.16
	129.5	54.5		0.90	-10.0	2220	
2.5	128.5	51.0	1.065	1.00	-17.5	3700	1.04
	128.3	51.0		0.90	-18.0	4220	
3.0	127.2	51.0	1.043	0.93	-27.0	6000	1.01
	127.0	51.0		0.84	-26.0	6400	
a	i	j	k	l	m	n	
1.0	- 3.0	780	1.54	2.20	-73800	-17470	
	- 3.5	780	1.79	2.60	-75000		
1.5	- 5.5	1210	1.62	2.15	-68400	-16250	
			1.65	2.20	-68600		
2.0	- 8.0	1680	1.95	2.50	-64700	-15510	
			1.73	2.20	-64700		
2.5	-11.0	2720	1.60	1.90	-63200	-15330	
			1.70	2.00	-62700		
3.0	-15.0	3730	1.57	1.85	-61500	-15270	
			1.48	1.75	-61700		

probably be mostly due to the smaller grain size obtained in our experiment. We believe that for  $\text{BaSO}_4$  the value of  $\sigma = 310$  ergs/cm<sup>2</sup> given by the lattice theory<sup>1</sup> is sufficiently correct for the present status of our knowledge about surface tension of solids.

<sup>1</sup> Neglecting change in the Madelung potential and putting the charge  $Z = 2$  we use the Born and Stern equation for the NaCl lattice.

An incomplete set of measurements in the region of small concentrations is given in Table II. The metathesis reaction

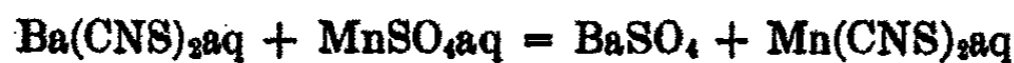

was investigated. Unfortunately difficulties in the preparation of  $\text{Mn}(\text{CNS})_2$  for the determination of the differential heat of solution prevented tem-

TABLE II

Molarity of $\text{MnSO}_4$	1.00	0.75	0.50	0.25	0.125	0.02
Heat of reaction in Joules/cm <sup>3</sup> .	14.9	14.9	14.4	13.2	12.5	11.9
Successive portions	14.8	15.5	14.6	13.6	12.6	12.1
	15.9	15.2		13.9	13.2	
				13.9	13.6	

porarily the complete evaluation of the data, but from the results of Table I and measurements on the differential heat of solution of  $\text{MnSO}_4$  show that the differential heats play only the role of correction factors and we get an insight into the process by investigation of the heat of the metathesis reaction only. Table II shows that in the region of concentrations below 0.75 molar the heat of reaction gradually decreases. The maximum difference is 3 Joules/cm<sup>3</sup> of the  $\text{Ba}(\text{CNS})_2$  solution between 1 molar and 0.02 molar solutions. The solution contained 0.0658 of Ba per cm<sup>3</sup> and consequently a surface energy difference is 1490 cal./mole. This result is in accord with the above mentioned observation about a maximum grain size for certain concentrations. The increasing values of  $\Delta H$  on further addition of reagent clearly show that  $\text{BaSO}_4$  precipitates on the nuclei already present and the grain size grows (surface energy decreases).

An investigation on the combinations  $\text{ZnSO}_4$ — $\text{BaClO}_3$ ,  $\text{SrClO}_3$ ,  $\text{CaClO}_3$ ,  $\text{PbClO}_3$  is now in progress. We hope to determine grain size as well and obtain directly  $\sigma$

#### Summary

1. Methods of determination of the surface tension of solids are discussed.
2. The calorimetric method is applied to the determination of the surface tension of  $\text{BaSO}_4$  and the order of magnitude of the theoretic value of  $\sigma = 310$  ergs/cm<sup>2</sup> is confirmed.
3. Surface energies as large as 2,200 cal./mole have been determined.
4. The existence of a region of maximum grain size for certain concentrations of the reagents in a metathesis reaction has been proved calorimetrically.

*Phys. Chem. Lab.  
University of Latvia,  
Riga, Latvia.*

## A LOW-PRESSURE TENSIMETER\*

BY K. C. D. HICKMAN

No simple relation has been found between temperature and vapor pressure for all substances.<sup>1</sup> Many of the proposed formulas involve physical constants, other than vapor pressure, and these may not be available. Thus Clausius<sup>2</sup> requires the molecular heat of evaporation, for the completion of his equations; and Nernst<sup>3</sup> the critical pressure. It is therefore not always safe to extrapolate pressure curves obtained at one temperature range for use at another range. Particularly is this true when the apparent vapor pressure of the substance is increased by decomposition or dissociation.<sup>4</sup>

We have for some time been interested in certain high boiling organic liquids for use in high vacuum work.<sup>5</sup> Of particular importance were their vapor pressures at the temperature of the laboratory and at that of the commoner refrigerating media such as ice, ice and salt, and solid carbon dioxide. When these high boiling liquids were heated sufficiently to give vapor pressures measurable in the usual apparatus<sup>6</sup> they showed decomposition, and the logarithms of the pressures, plotted against the inverse of the absolute temperatures, as recommended by Dushman,<sup>7</sup> did not fall on lines sufficiently straight for extrapolation. It was decided therefore to measure the vapor pressures at the lowest pressures that could be read conveniently.

Little direct work on small vapor pressures has been recorded. Ramsay and Young<sup>8</sup> read to about one millimeter of mercury, and Hertz, who worked to a small fraction of a millimeter, did not obtain accurate results. All the recent investigators on low vapor pressures<sup>9</sup> have used indirect means involving determinations of rate of diffusion, viscosity, ionic conductivity, and so forth, which require assumptions concerning the structure and degree of association of the vapor. The apparatus now presented does not provide a satisfactory means for determining low vapor pressures. It does, however, yield determinations in the region between atmospheric pressure and one-twentieth of a millimeter of mercury, and thus extends the readings to a lower limit than ordinarily recorded. Furthermore, it is quick and convenient in use.

A direct measurement of vapor pressure demands that the measuring instrument shall be in contact with the vapor and at the same temperature as the vapor; or that the vapor shall meet a column of a permanent gas, such as air, so that the pressure of the gas may be measured outside the apparatus. Now, the McLeod gauge is valuable as a manometer because, at pressures comparable with that of mercury at room temperature (1/1000 mm.), the mean free path of the gas molecules is sufficiently large for the molecules to

\* Communication No. 391 from the Kodak Research Laboratories.

diffuse into the McLeod gauge unhindered by the stream of mercury vapor which may be passing in the opposite direction. It is manifestly impossible to measure the pressure of a tenuous vapor in one vessel by measuring the pressure of a permanent gas in another communicating vessel, if the pressure is low enough for the gas and the vapor to diffuse independently and unhindered by one another. The method is valuable only when the molecules are sufficiently crowded for the gas to bar the entrance of the vapor almost entirely during the time of experiment. The practical question at issue is at what pressure this buffering action breaks down.

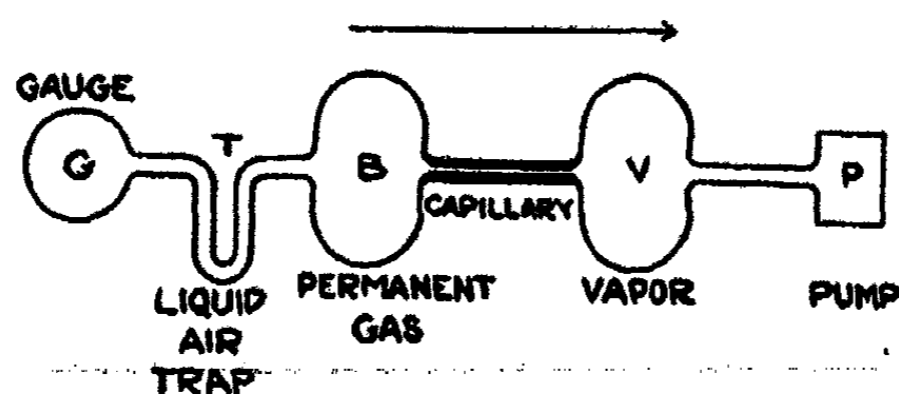

FIG. 1

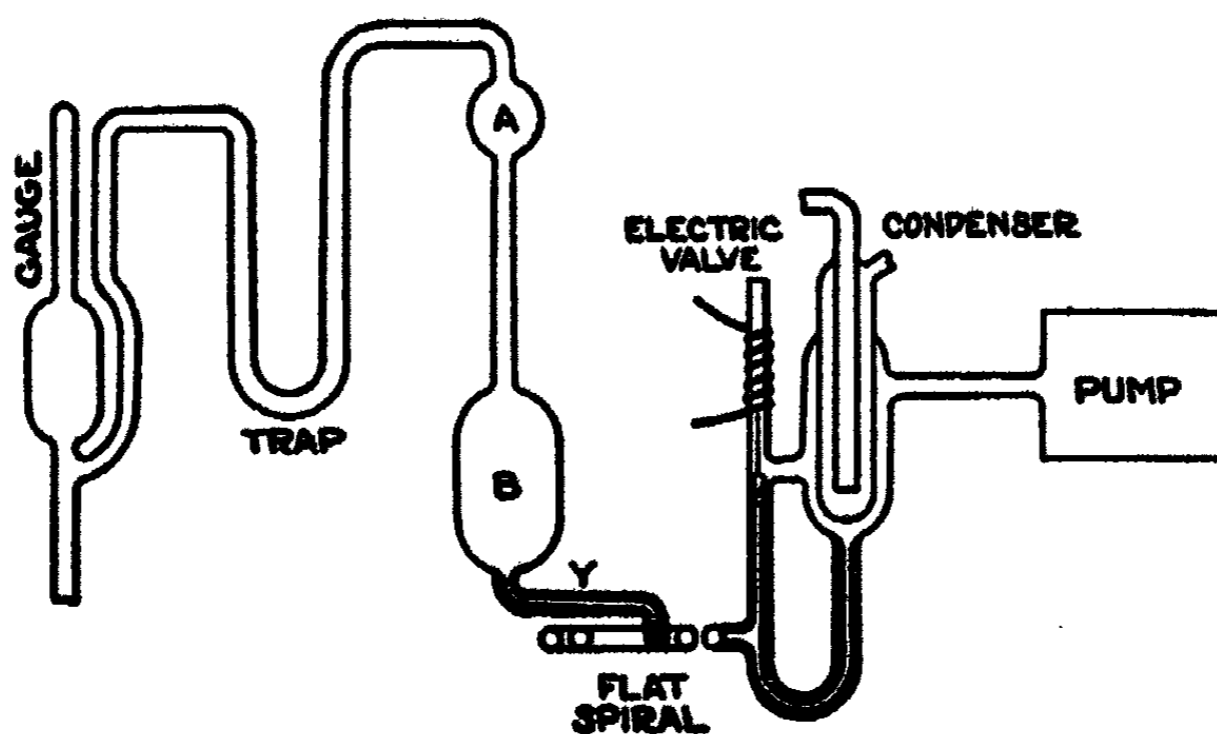

FIG. 2

Consider the system shown diagrammatically in Fig. 1. The substance providing the vapor is placed in the bulb, V, in sufficient quantity for a non-gaseous phase always to be present. We will suppose that the evaporating surface in V is large compared with the capacity of the pump, P, so that a saturated vapor is maintained in V even during the operation of the pump. At the commencement of evacuation the pressure in the system is much higher than the vapor pressure of the substance and the pressure falls nearly uniformly throughout. When the pressure of the substance is nearly reached the pump will be concerned almost entirely with the removal of vapor. No more of the permanent gas will *stream* from B into V, although a little will *diffuse* through the vapor column. The gauge will indicate the pressure of the vapor as long as sufficient air remains undiffused.



There are cases, however, in which the vapor pressure is very small, where molecular collision occurs so seldom that the distinction between stream flow and diffusion vanishes and the permanent gas in B can pass through V to the pump as though no vapor were present. The pressure at which hindered flow gives place to unhindered diffusion varies with the nature of the vapor, the size of the apparatus, and the duration of the experiment. It occurs at about 0.10 mm. with mercury and at about 0.05 mm. with most heavy organic substances, in apparatus of the dimensions suggested here. The transition is extraordinarily sharp, for complete obstruction may exist at 0.08 mm. and complete breakdown at 0.04 mm.

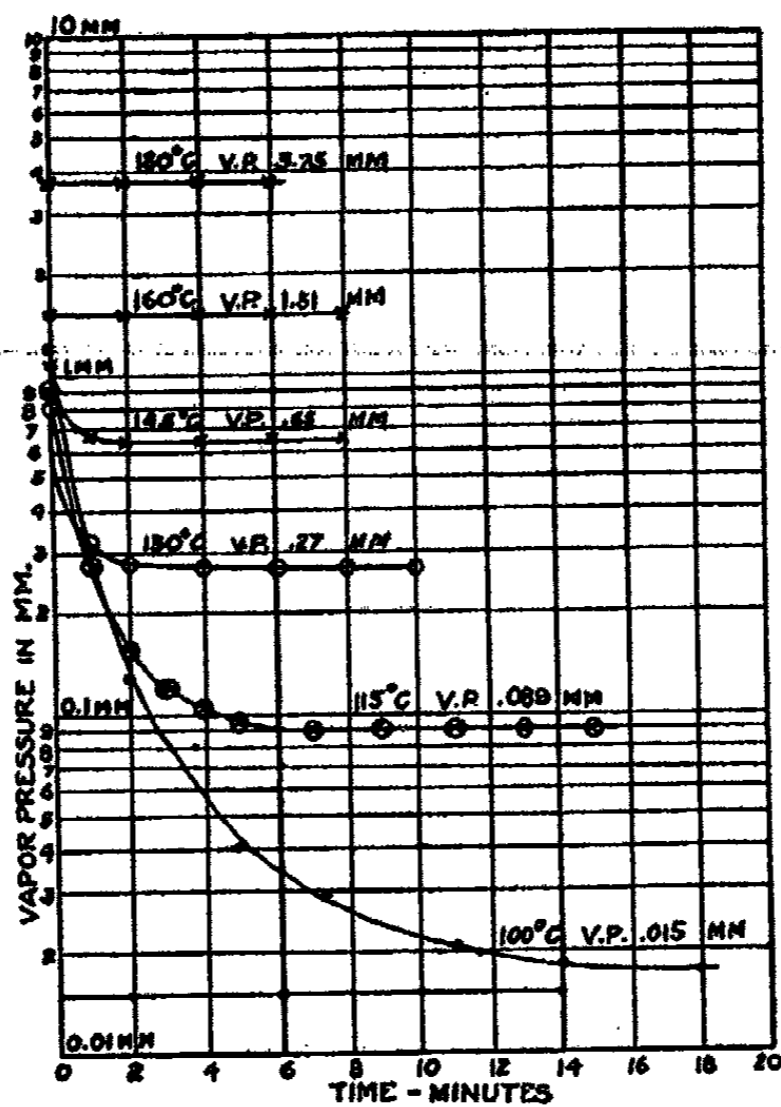

FIG. 3

We have experimented with a tensimeter utilizing the pressure region before breakdown. The essentials are shown diagrammatically in Fig. 2. A McLeod gauge, protected by refrigerant, measures the pressure in the bulb, A, which rests at room temperature. A larger bulb, B, which is immersed in an electrically-warmed oil bath, communicates with A. The bottom of the bulb, B, opens into a flat spiral tube, Y, which is half filled with the liquid under examination. At the other end of the spiral there is a two-way connection by capillary tubes with a small condenser which is itself connected by a third pipe to a vacuum pump. The upper capillary contains a magnetically operated ball valve and it is this device which controls the passage of vapor to the condenser and thus the exhaustion of the bulbs. The lower capillary is a return tube for condensed material.

The use of the apparatus raised some interesting points. It was the general practice to heat the bath until the liquid developed a vapor pressure of about 4 mm. The vacuum pump was started and the fall of pressure was plotted against time until no further change was recorded. A curve such as (a) in Fig. 3 would be obtained.\* The inability to reduce the pressure below 4 mm. suggested that the capacity of the capillary was used completely in conveying vapor to the condenser and that the capillary, Y, was providing a region where the air flow from B was checked by the vapor from the spiral. The magnetic valve was now closed so that further evacuation of the system ceased. To our satisfaction no increase in pressure was recorded at the gauge. The supply of vapor and the consequent loss of heat all occurred at one end of the spiral while at the other end vapor at the true temperature of the bath barred the entrance. It was therefore not essential to include a stop valve in the capillary of any later apparatus.

The dimensions of the spirals and the capillary tubes were varied many times to find whether the vapor pressures recorded at different temperatures varied with the design. If the spiral was too small or was replaced by a bulb, and the capillary was of large diameter, then no steady back pressure was recorded. When the spiral was longer than a certain minimum in relation to the capillary, increasing the length gave no additional buffering action. The vapor pressures were independent of the shape of the apparatus.

The physical event being measured was, of course, not the vapor pressure, but the rate of fall of pressure in the system. The vapor pressure was assumed to be that pressure at which the rate of exhaust became indefinitely small. It was essential that the exhaust pump should be able to maintain a comparatively perfect vacuum in the condenser and, secondly, that the fall of pressure against time should be recorded in well balanced units. The constant vacuum was secured by inserting between the apparatus and the "Hyvac" pump a small air-cooled condensation pump actuated by butyl phthalate.<sup>10</sup>

The choice of co-ordinate dimensions in plotting was made to give the maximum change of slope (on semi-log paper) at the region approaching vapor pressure. The vapor pressure would be reached when the initial rate of exhaustion had decreased more than fifty-fold.

The apparatus had one valuable characteristic. Cyclic distillation was occurring all the time and dissolved gases were sucked away so rapidly that they exerted no measurable pressure. Organic liquids at 20°C. dissolve, on an average, 8% by volume of air.<sup>5</sup> If this solution has occurred at atmospheric pressure, the volume liberated at 0.05 mm. is some twelve hundred times that of the liquid. The gas may take hours for complete removal during which time, in any static system, or system of intermittent evacuation, its influence will be felt. In our apparatus the effect of dissolved air is not noticeable after the first few minutes *providing the high temperatures and pressures are recorded first.*

\* Exhaustion was always so rapid at this pressure that the equilibrium position was reached before the first measurement and the curve became a straight horizontal line.

*Constructional.*—A tensimeter for routine service work has recently been built and has proved sufficiently satisfactory to remain in constant use. The glass work is grouped around two stalwart wood uprights connected at the top by a piece of soft pine. The uprights are fastened at the base to a small carriage on castors which is weighted down with a gasometer, pump, and

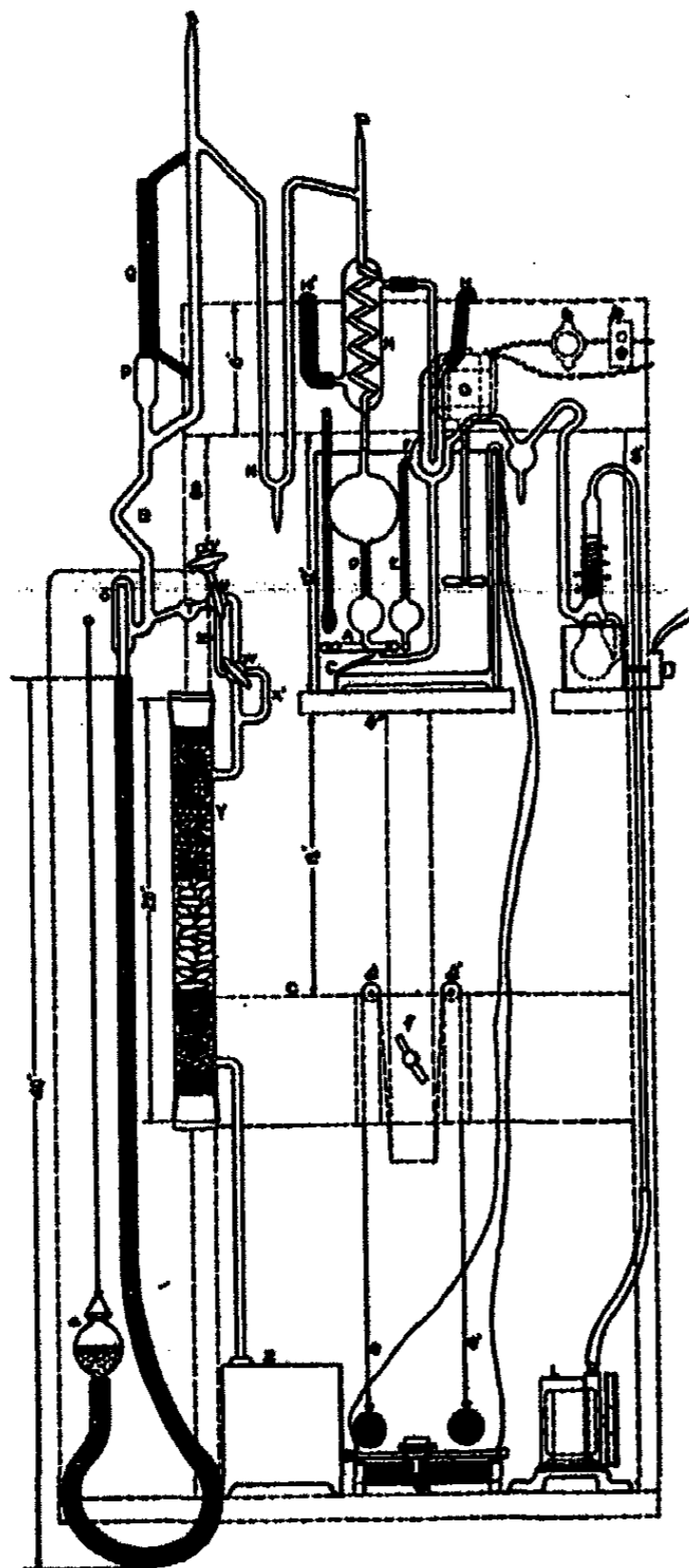

FIG. 4

Tensimeter for the determination of low vapor pressures

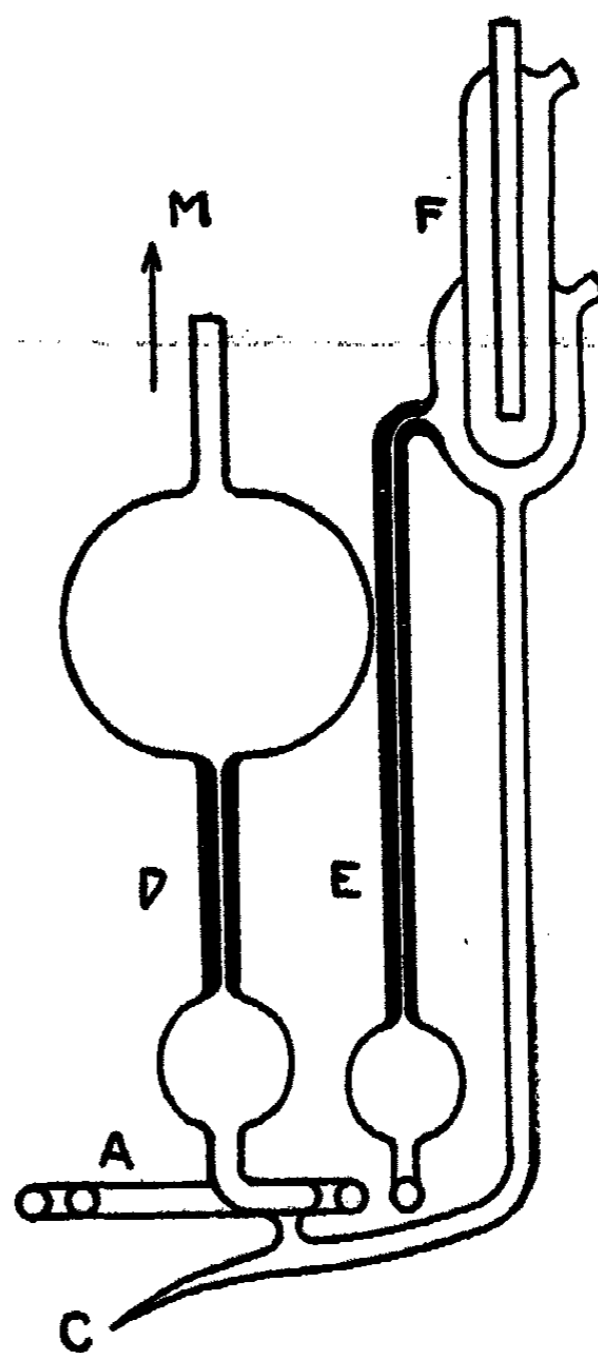

FIG. 5

cylinder. Approximately halfway up the woodwork is a crosspiece supporting a rising table. The arrangement is best understood by reference to the side elevation in Fig. 4 and the photographs, Fig. 7-10. The vapor unit and the stopcock mechanisms are detailed in Figs. 5 and 6.

Referring to Figs. 4, 5, and 7, A is the spiral and B the diffusion bulb. C is the filling tip, D and E are the capillaries, and F and M are condensers

REPRODUCED FROM THE JOURNAL OF THE AMERICAN CHEMICAL SOCIETY, VOL. 47, P. 1000, 1925.

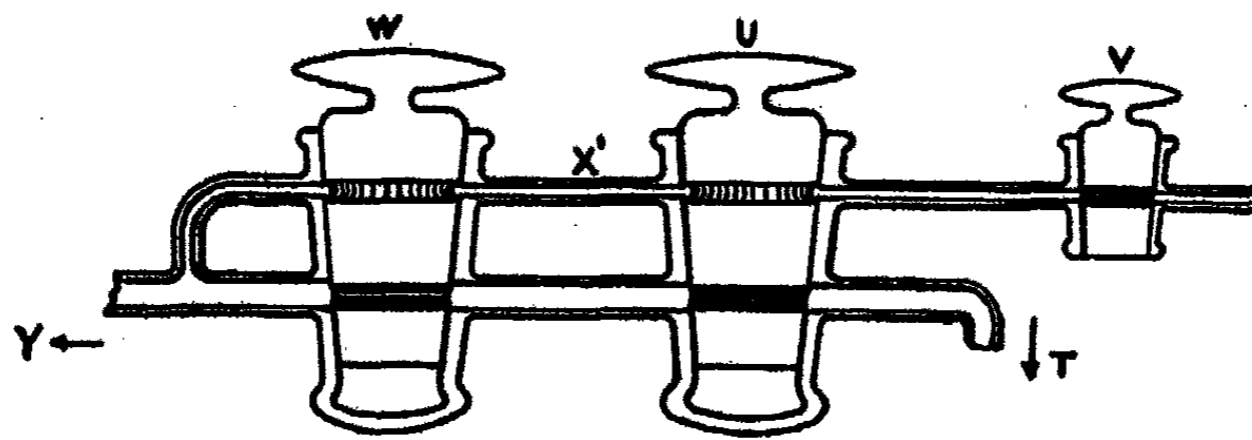

FIG. 6

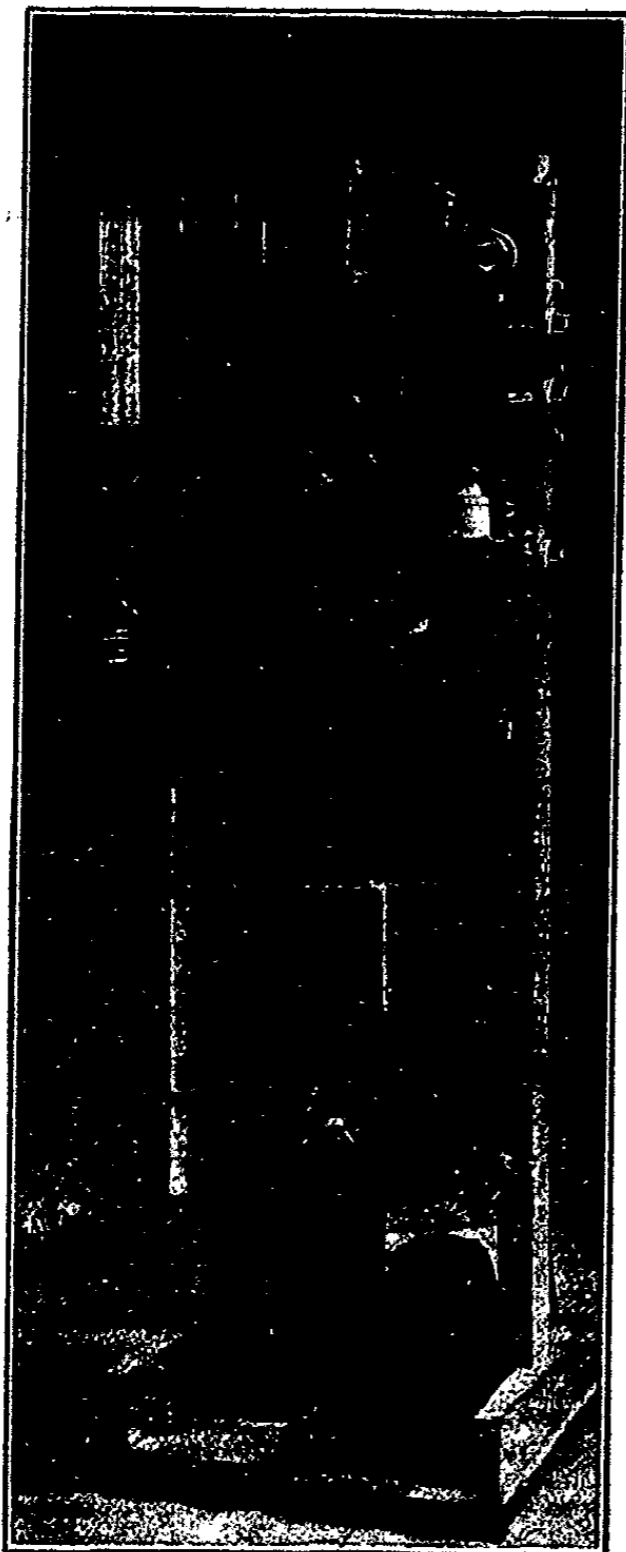

FIG. 7



FIG. 8

trapping the hot vapor. The bulb and spiral are immersed in a large battery jar filled with heavy white oil which can be heated by the electric winding, *r*, controlled by the resistance, *m*. The temperature is kept even throughout the bath by the motor and stirrer, *G*. On the right of the bulb and spiral is a safety trap and the butyl phthalate pump which leads to the "Hyvac" oil pump. On the left is another safety trap for immersion in solid carbon dioxide and acetone, or liquid air. The trap communicates with the McLeod gauge.

Only dry nitrogen is allowed to enter the system, the gas being derived from a small commercial cylinder by way of a gasometer containing heavy oil. The nitrogen is admitted through a drying column holding solid potash, calcium chloride, and phosphorus pentoxide in series. Two stopcocks, *W* and *V* (Fig. 6), in series, control the supply of gas and are so arranged that a known amount of nitrogen held in the tube between them can be admitted to the apparatus. The possibility of inward atmospheric leakage is prevented by conveying nitrogen in annular channels around the upper parts of the stoppers.

*Determining Vapor Pressures.*—The apparatus must be cleaned thoroughly with volatile solvents and then ventilated freely. The liquid under test is sucked in at the broken tip, *C*, which is then sealed. The apparatus is evacuated to about 10 cm. of mercury and the temperature is raised until the vapor pressure is at least twice that which is required for the highest reading. The vacuum pump is operated, and, when the pressure will fall no more, the stopcocks are manipulated five or six times in as many minutes to admit enough nitrogen to sweep back any vapor which may have diffused from the spiral to the bulb, *B*.

The temperature is now allowed to fall about 3° a minute until the selected top temperature is reached. Nitrogen is admitted and a pressure-time curve plotted while the temperature is kept constant. The pressure soon reaches a steady value which may be considered equal to the vapor pressure of the substance at this temperature.

The next reading is obtained at a temperature 10° or 15° lower. Nitrogen may be admitted; or the pressure curve may be recorded from expansion of

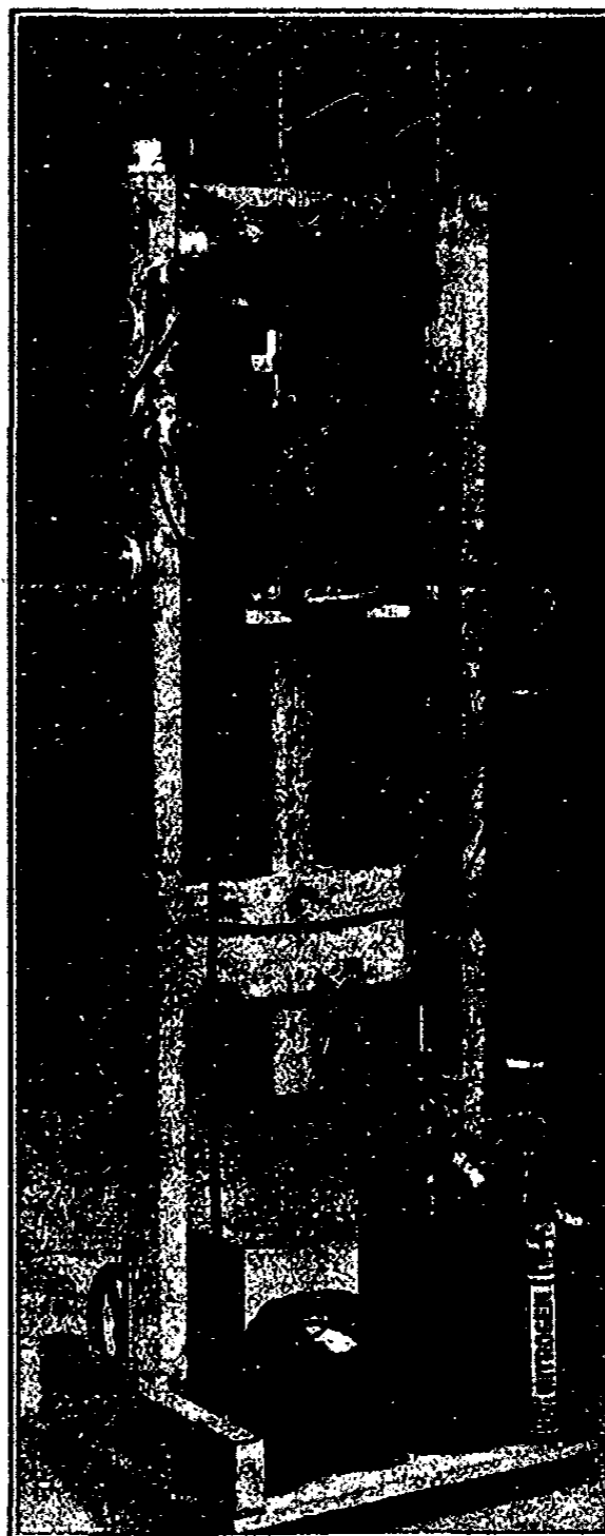

FIG. 9

the nitrogen left in the bulb after the last reading. We have found generally no difference in the values at each temperature whether nitrogen was admitted once only at the beginning of the series or again before each reading. It is much quicker to admit the gas once only.

It is convenient to record the vapor-pressure-temperature relation graphically by plotting the logarithms of the pressures against the inverse of the absolute temperature.

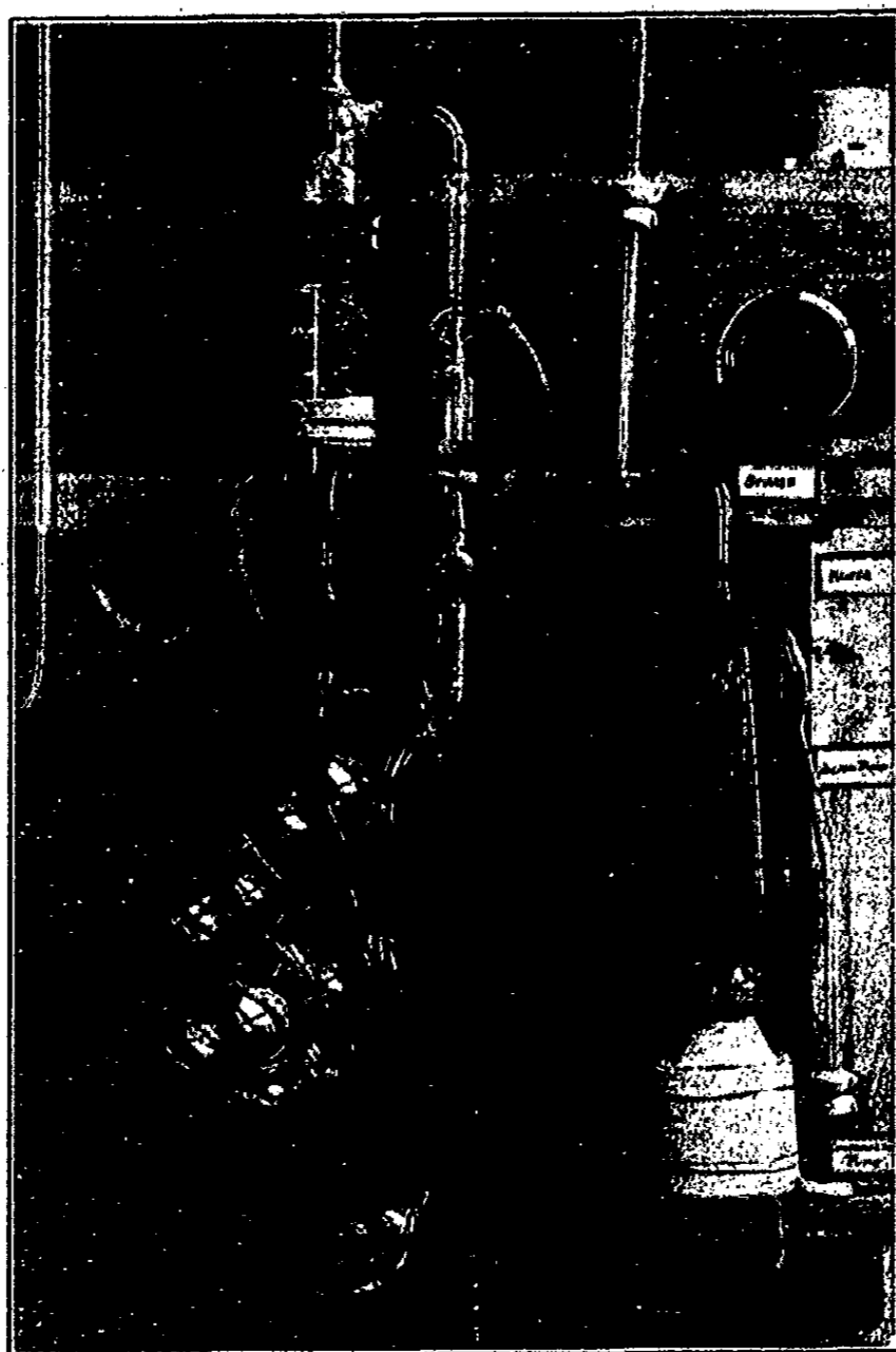

FIG. 10

The curves for a number of substances are shown in Figs. 11, 12, and 13. No attempts have been made to test the curves by the formulas of Clausius,<sup>3</sup> Biot,<sup>2</sup> or Rankine<sup>11</sup> because in this work the vapor pressures, in the region before breakdown, were found to lie so nearly on straight lines that it seemed more accurate to extrapolate these where necessary than to calculate the latent heats step by step from the same numerical data that supplied the curves. Special attention has been paid to the phthalic esters, which are recorded separately in Fig. 13. So perfectly parallel do the curves lie that a knowledge of the boiling point at any one pressure of a member of

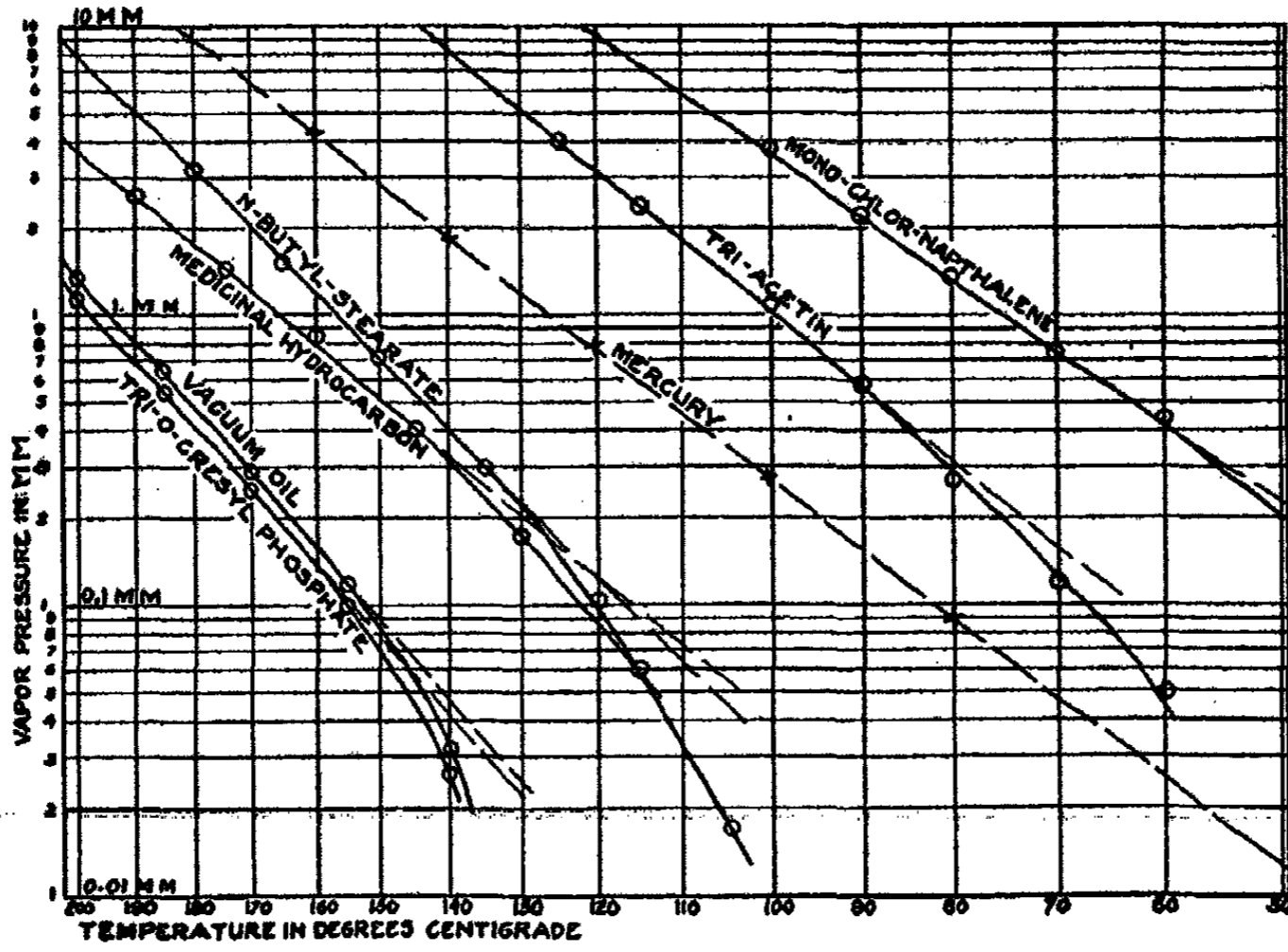

FIG. 11

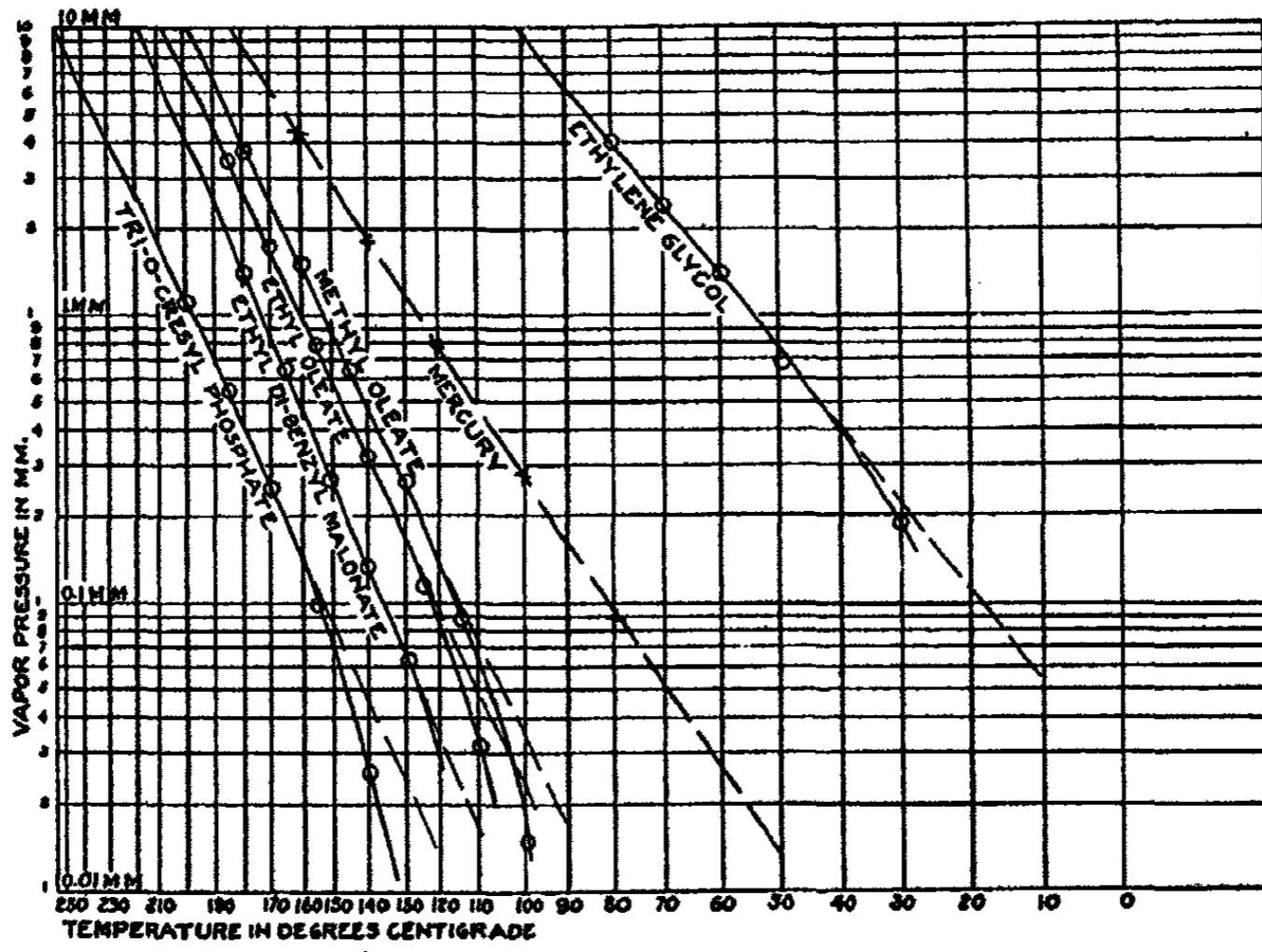

FIG. 12

the series enables its boiling point at any other pressure to be predicted with certainty.

It is perhaps superfluous to remark that all samples to be used in the apparatus must be most carefully fractionated. We have found slow sublimation<sup>5</sup> in a vacuum most advantageous for the final purification.

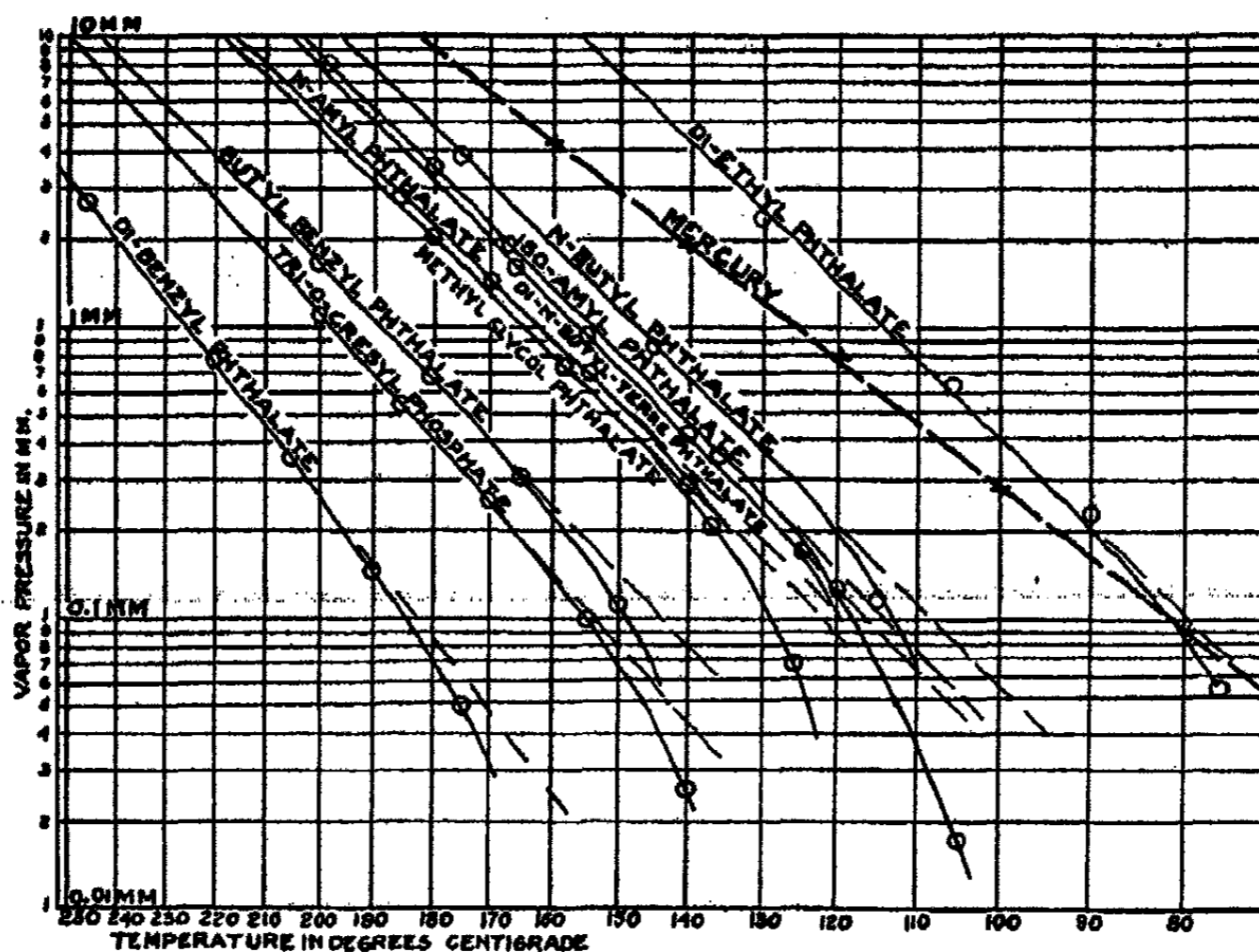

FIG. 13

The apparatus is recommended especially for use with gasolines on the one hand, and for heavy lubricating oils on the other. A complete determination, including cleaning, refilling, and warming, takes less than three hours. It is necessary that some portion of the tube leading from the vapor bulb to the McLeod gauge shall be more than 80°C. lower than the temperature in the bulbs. Therefore when working with heavy lubricating oils no refrigerant is needed at the traps; but with gasolines and the more ordinary organic liquids, solid carbon dioxide or liquid air should be used.

#### References

- <sup>1</sup> Preston: "Theory of Heat," 3rd Ed., p. 393 (1919).
  - <sup>2</sup> Ham, Churchill and Ryder: *J. Franklin Inst.*, 186, 15 (1918).
  - <sup>3</sup> Nernst, W.: "Theoretical Chemistry," Ed. 5, London, Macmillan & Co., Ltd., p. 814 (1923).
  - <sup>4</sup> We have found the heavy paraffin hydrocarbons evolve products of cracking at temperatures below 200°C.
  - <sup>5</sup> *J. Phys. Chem.*, 34, 637 (1930).
  - <sup>6</sup> Regnault: *Mémoires de l'Académie*, 26, 51 (1862).
  - <sup>7</sup> Dushman: "High Vacua," *General Electric Review* (1922).
  - <sup>8</sup> *J. Chem. Soc.*, 47, 42 (1885).
  - <sup>9</sup> Egerton: *Phil. Mag.*, 33, 33 (1917); Swan and Mack: *J. Am. Chem. Soc.*, 47, 212 (1925); Langmuir: *J. Am. Chem. Soc.*, 35, 107 (1913); *Phys. Rev.*, 2, 239 (1913); Pirani: *Verh. deutsch. physik. Ges.*, 4, 686 (1906).
  - <sup>10</sup> *Rev. Sci. Instruments*, 1, 140, March, 1930.
  - <sup>11</sup> Griffin: "Miscellaneous Scientific Papers," (1881).
- Rochester, N. Y.



## THE PURIFICATION, PROPERTIES, AND USES OF CERTAIN HIGH-BOILING ORGANIC LIQUIDS\*

BY K. C. D. HICKMAN AND C. R. SANFORD

Much laboratory technic has been made possible by the unique properties of mercury. A heavy, unreactive liquid of low vapor pressure and viscosity, it has proved eminently fitted for use in manometers, pumps, and gasometers where it provides an excellent liquid seal. It may well be called the universal fluid piston. Mercury has, however, some minor disadvantages which occasionally prevent its use. The objections will not always be of moment, but they are prohibitive in special cases. The properties of mercury which are of importance in the present paper are summarized in Table I.

TABLE I

No.	Property	Remarks
1.	Mercury is metallic	The manometer column may be required not to conduct electricity. The metallic vapor may be objectionable.
2.	Mercury has a very high surface tension.	Does not form a definitely reproducible meniscus. The column may stick in glass tubes.
3.	The vapor pressure is above 0.001 mm. at room temperature.	A powerful refrigerant must be used for high-vacuum work.
4.	Mercury vapor is monatomic.	The vapor is not so easily condensed as is that of associated liquids.
5.	Mercury does not dissolve foreign gases.	Mercury is immensely superior in this respect to all common fluids.
6.	Mercury is an element.	Mercury will withstand boiling indefinitely without alteration, in which respect it is superior to all organic liquids.

It will be seen that there is a sphere of usefulness for liquids which are superior to mercury in one or more of the first four particulars. There is also a field for a liquid which will lubricate the mercury meniscus, allowing it to slip without static friction along glass tubes. The present research was under-

\* Communication No. 394 from the Kodak Research Laboratories.

638 taken primarily to find a fluid to lubricate the meniscus of a mercury column in a special apparatus which has been described elsewhere.<sup>1</sup> It was found that a survey of many collateral and dependent matters was involved; and this paper is an account of such of these as may prove of general interest.

The most important characteristic of a liquid to replace mercury is low vapor pressure. Second in importance is stability on boiling. In this connection we must be able to secure the liquid in a pure state and should be able to ascertain the relation between the pressure of its vapor and the temperature. The distillation of high-boiling organic liquids is therefore a necessary preliminary to the study of the liquids themselves. The special apparatus which we have evolved for these distillations have been described in preliminary notices appearing in the *Journal of the American Optical Society*,<sup>2</sup> and in a technical circular.<sup>3</sup> We now offer a more comprehensive account.

*Vacuum Distillation.*—A substance of limited stability will generally approach decomposition as the temperature rises. If the boiling occurs at a low temperature, the substance becomes automatically protected from thermal damage. When boiling occurs normally at too high a temperature, it may be necessary to reduce the pressure so that the new boiling point may be below the limit of instability; we institute vacuum distillation. Whether the beneficial effect of evacuation on stability is due solely to the lower temperature of boiling or is assisted by the longer free path secured for the molecules in the vapor phase, is a moot point. We conceive however that both temperature and free path are of importance, although only the former can influence the internal translatory movement of the molecules.

We must distinguish at the outset most carefully between distillation and fractionation. Distillation may *achieve* fractionation when the boiling points of the mother liquid constituents are widely separated; but in other cases special precautions should be taken to prevent condensation of the lower boiling fraction while the higher boiling is being collected. In the remarks immediately following, we refer, except where otherwise specified, to distillation, and the condensation of all\* the components volatilized from the parent liquid.

Consider the conventional distilling flask and receiver pictured in Fig. 1. The liquid in the flask gives off vapor at its surface which passes towards the neck in the slow stream, A. At the neck, the molecules become crowded in the faster stream, B,\*\* whence they must again become accelerated on passing into the narrow tube, C. The mean forward molecular velocity in each section will be inversely proportional to the square of the diameter of the section. Thus, if the flask is 10 cm. in diameter and the vapor stream at A is moving upwards at 10 cm. per second, the velocity in B whose diameter is two centimeters must be 250 cm. per second. In the side tube, C, of diameter of half a centimeter the velocity is 40 meters a second.

\* This does not include volatile impurities and products of cracking which may be removed by the pump.

\*\* We are considering pressures above 1 mm. of mercury where the mean free path is small. At very low pressures the forward molecular velocity remains unaltered.

Now the flow of gases through tubes at ordinary pressures is deducible<sup>63</sup> from Poiseuille's equation<sup>4</sup>

$$q = \frac{\pi D^4}{128 \eta L} \cdot p (p_2 - p_1)$$

The quantity of gas transferred is dependent on the product of the pressure and the pressure difference which in this case is approximately equal to the square of the pressure in the flask. The quantity is also dependent on the fourth power of the diameter of the tube and the viscosity of the gas.

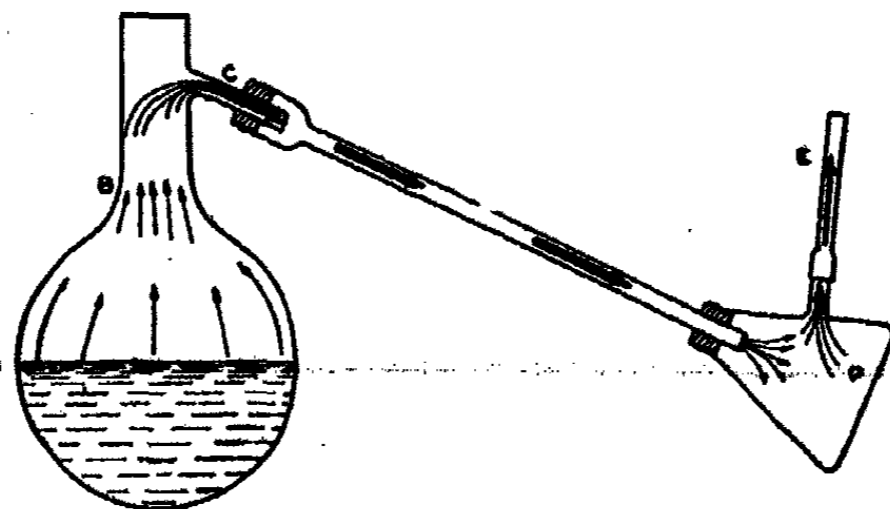

FIG. 1

Now  $q$  in the equation is the quantity p.v. of gas transferred from the flask measured in cubic centimeters and millimeters of mercury, hence

$$p.v. = \frac{\pi D^4}{128 \eta L} \cdot p^2$$

$$\text{and } p = \frac{v \cdot 128 \eta L}{\pi D^4} \text{ dynes per cm}^2$$

In our original postulate  $v$  is 780 c.c. per second,  $L$  is 20 centimeters, while  $\eta$  may be taken as  $1.7 \times 10^{-4}$

$$\text{whence } P = \frac{780 \times 128 \times 1.7 \times 10^{-4} \times 20 \times 750}{(0.5)^4 \times 10^6} = 4.07 \text{ mm.}$$

We see, therefore, that a fall of pressure of 4.07 mm. is involved in the passage of the gas down the tube, and that even with a good vacuum secured at the exhaust end a pressure of at least\* 4 mm. must be produced in the flask to overcome friction in the exit pipe. There are many liquids which are unstable, however, even if volatilized at pressures as low as 0.001 mm. Now at pressures of the order of one bar and less, the laws governing gaseous flow alter entirely and may be expressed according to Knudsen<sup>5</sup> by

$$q = \frac{(p_2 - p_1)}{W \sqrt{\rho}}$$

\* The calculations given above do not account for the acceleration of the gas *en masse* from zero to a velocity of 40 meters per second.

$6^{10}$  where  $w$  is the frictional resistance of the tube and  $\rho$  is the density. For long circular tubes the flow becomes

$$q = 3809 \sqrt{T/M} \cdot D^3/L (p_2 - p_1)$$

Here the quantity increases with the cube of the diameter but inversely as the first power of the length. This means that although narrow tubes do not offer quite such a great proportionate resistance at low pressures the mass of gas transferred becomes very small indeed.

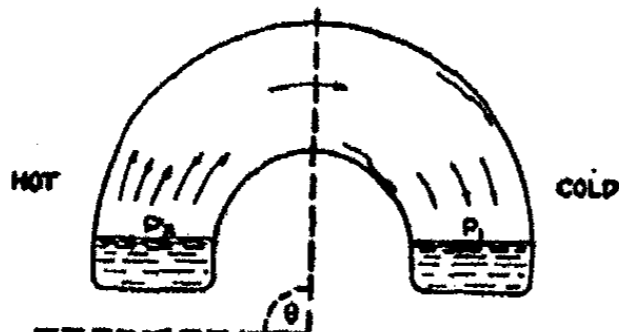

FIG. 2

A sample of fluid which in a certain distillation train distilled  $X$  cubic centimeters in half a minute at 10 mm. pressure, would take

about 1 hour at 1 mm. pressure, or  
1 week at 0.1 mm. pressure, or  
2 years at .01 mm. pressure,

and perhaps 40 years at .001 mm. pressure, and no added efficiency in pumping would accelerate matters.

The remedy, therefore, and the only remedy, if distillation is to take place at very small pressures in a reasonable time, is to redesign the apparatus,

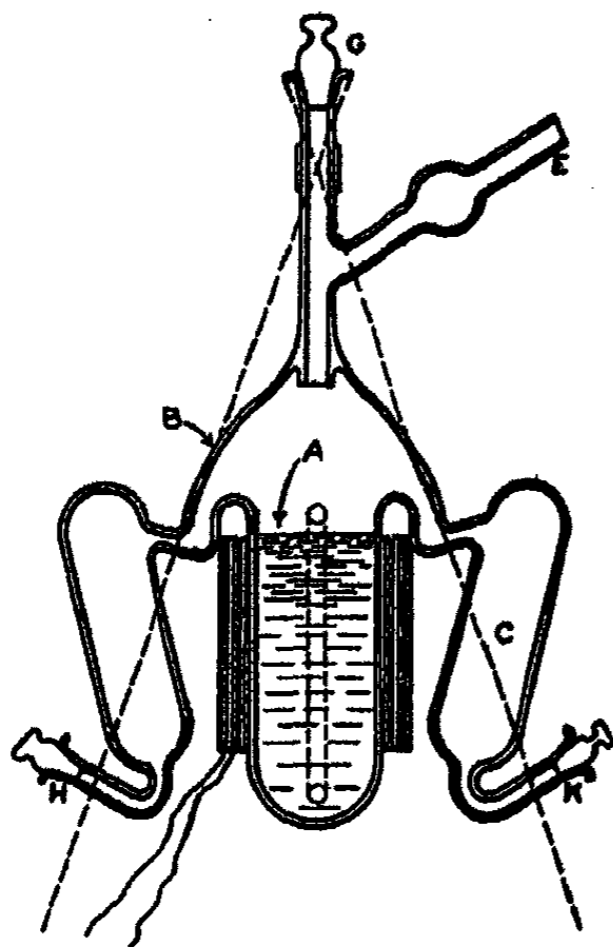

FIG. 3

making the diameter ( $D$ ) large and the distance ( $L$ ) between the distilling and receiving surfaces small. This can be done most simply by enclosing the liquid in a squat inverted U-tube. One end is warmed and the other kept cold and the vapor passes in the direction shown by the arrows in Fig. 2. Actually, if the vapor is to survive until the proper place, the whole region embraced by the angle has to be kept warm, a matter difficult of practical accomplishment. A  $5^\circ$  fall in the jacket temperature below that of the liquid may cut the distillation to one-half, and a substantial increase may produce decomposition of the vapor. We have therefore found it convenient to substitute for the U-vessel an alembic such as that pictured in Fig. 3.\* Here the retort passes directly to an inverted condenser of umbrella-like

form terminating in a drainage annulus and receiving flask. Vapor escaping from the surface in A can pass directly to B suffering no hindrance from the

\* The figure shows a still, more complicated than suggested in the text. For the use of these features reference should be made to the previous papers: J. Opt. Soc. America, loc. cit.

walls of the vessel. Such an alembic serves excellently for liquids of moderate volatility but the modification in design has still not been carried far enough for viscous mixtures with a very high boiling or non-volatile constituent. The failure to function is due partly to absence of ebullition or stir-

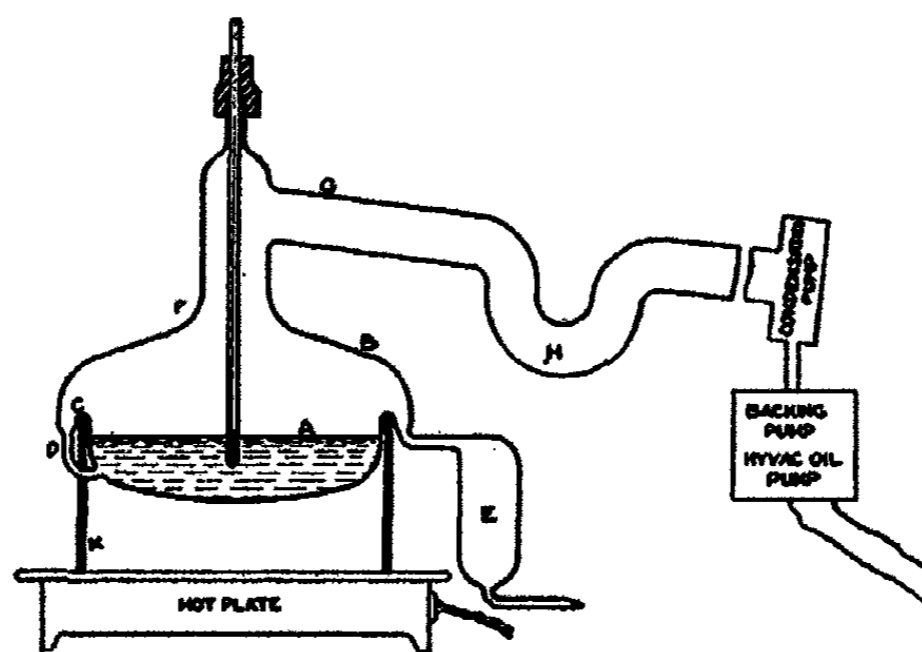

FIG. 4

ring, and a skin may form on the surface as the liquid recedes in A, which permits scarcely any vapor to reach B. Working from a 500 c.c. flask in the place of tubing, however, we found it possible to make an alembic of smaller depth and much larger working surface like the one shown in Fig. 4 which has an evaporative area of 50 sq. cm. and a condensing surface of about double that amount. The pressure tending to collapse the two halves at the annulus is over 200 lbs. under complete exhaustion, and it is not surprising if a weight equal to that of a heavy man, pressing on the  $4\frac{1}{2}$ -inch alembic more often than not produces collapse. The point of weakness is the annulus: the convex top and bottom withstand the strain successfully. The problem of catching the distillate without an annulus has yielded the apparatus of Fig. 5, where drops collecting at the point, P, on the condensing surface, B, fall down the tube, C, and out of the still.

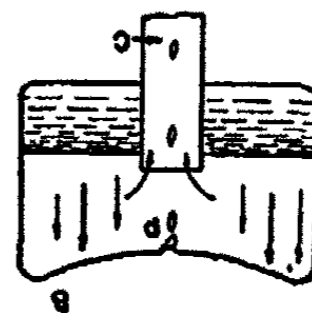

FIG. 5

There remains a practical difficulty to be removed. Langmuir<sup>6</sup> has shown that a surface wetted by a liquid condenses every molecule incident. If the liquid is substantially non-volatile at the temperature of the surface, the molecules will seldom re-evaporate and the surface will permanently remove all molecules that strike it. The walls act therefore as though they offered no barrier between the surface of the liquid and an indefinitely large evacuated vessel into which the vapor might pass and be lost. If, also, we imagine the tube, C, connected with a pump of great capacity, molecules of vapor entering will also disappear at a rate depending on the area of the opening and the resistance of the tube. Let the area of the opening be  $a$  and the effective area  $a'$ . Let also the superficial condensing area of the still be  $A$  and the effective area, allowing for re-evaporation, etc., be  $A'$ . Now evidently  $a'$

<sup>642)</sup> and  $A'$  need be only slightly smaller than  $a$  and  $A$ , so that for comparison of  $a'$  with  $A'$  we may compare  $a$  with  $A$ . As a practical example, a flask in our possession has the following measurements: diameter of container 10 cm.; diameter of fall tube 1.5 cm. Neglecting the walls of the still, which may be kept warm by lagging, the ratio of  $A'$  to  $a'$ , at a conservative estimate is  $10^3 : 1.5^2$  or forty-four and one-half to one. This means that if the substance we are distilling cracks, yielding one part in forty-four of non-condensable vapor, which can only be removed by way of  $C$ , then of every two molecules of gas in the alembic one will be condensable and one will not. Let us further suppose that the exit tube  $C$  is connected to an oil pump by tubing 5 mm. in diameter\* and 20 cm. long. The ratio now becomes  $A' : a' : : 400 : 1$ . If the pressure is less than 1 bar,\*\* the gas is obeying molecular flow laws,<sup>7</sup> dependent on the *cube* of the diameter, and the ratio of  $A' : a'$  will be vastly greater than  $A : a$  and will be in excess of  $10^3 : 0.5^3$  or eight thousand to one. A decomposition of 1% or an evaporation of 1% of residual solvent or some more volatile impurity will maintain in the alembic anywhere from 8 to 80 molecules of something other than the distillate for every molecule of the latter.

The effect of the gaseous impurity is to decrease the mean free path of the molecules, which in turn reduces the likelihood of a vapor molecule reaching the condenser. The inert gas blankets the evaporative surface just as argon prevents volatilization of tungsten from a metal filament in a gas-filled lamp.

It has been deduced from the kinetic theory<sup>8</sup> that the mean free path is inversely proportional to the density, and therefore varies almost directly with the pressure. It is affected also by the viscosity of the gas, the molecular weight and molecular projective areas, and the temperature. It is therefore not possible to predict the exact free path of the particular substance which the reader may choose to distill. On the other hand, it is possible to predict the average free path of the oxygen and nitrogen molecules remaining at any given residual pressure from the equation:<sup>8a</sup>

$$\eta = .3502 \rho .14551 \sqrt{T/M} \cdot L$$

when  $\eta$  is the internal viscosity,  $\rho$  the density, and  $L$  the mean free path.

With air the average path is  $8.6 \sqrt{T/273} \times 10^{-6}$  cm. at atmospheric pressure.

At 1.0 mm. of mercury the average free path is	0.00562 cm.
0.1 mm.	.0562
.01 mm.	.562
.001 mm.	5.62

The table shows that unless the pressure of the residual gas is less than one thousandth of a millimeter of mercury, the average path of the vapor molecules will not be sufficient for the majority to reach the condensing surface without collision. Fairly volatile liquids which we may distill at above 0.1

\* This is an unusually large diameter for most thick-walled tubing.

\*\* One millionth of an atmosphere.

mm. carry forward the residual gas and push it into the exit pipe so that it<sup>43</sup> is rapidly brought to an unmeasurable concentration—the still acts as its own condensation pump. The vapor then streams towards the condensing surface, with many collisions it is true, but without the forward product of the collision being most often an uncondensable molecule. Distillation and condensation are thus extremely rapid.

It is when the vapor pressure of the distillate is of the same order as the pressure of the residual gas that this residuum must be so perfectly removed. The harmful pressure is a direct function of the average free path. If the distance between the distillation and condensation surfaces is 5 cm., the pressure must be less than 0.001 mm.; if 0.5 cm., then less than 0.01. We have accordingly constructed some distilling vessels in which the surfaces have been brought very close indeed without impairing the facilities for removing the residual gas. In the three figures (Figs. 6, 7, and 8) shown, A is the exit pipe to the pump, B the outflow tube(s) for distillate, C the condensing surface, and T a recess for the thermometer. The type of vessel which is chosen is purely a matter of expediency. No. 6 must be small to avoid constructional weakness and will be useful for samples up to 50 c.c. Its advantage is an under surface free from protrusions, enabling the still to rest on a hotplate.\*



FIG. 6

The type shown in Fig. 8 can accommodate 200 c.c. of liquid which it will then distill into three portions without breaking the vacuum. It is so clamped that it can be tilted about the axis of the exit tube, A. The receiving flasks are fastened by well-matured rubber stoppers to the tubes, B. The liquid is introduced through the constricted tube, E, which is then sealed, and the vessel is tilted to a somewhat acute angle. Evacuation is commenced and then gentle heating is applied until frothing ceases and distillation starts. The first runnings and splashings fall from the tip, P, against the wall of the fall tube, and wander into B<sup>2</sup>. The flask is now tilted again for the distillate to drop into the funnel communicating with B<sup>1</sup> until a sufficient fraction has been collected. Another shift of position enables a further fraction to be caught in B<sup>3</sup> while the residue remains in the still.

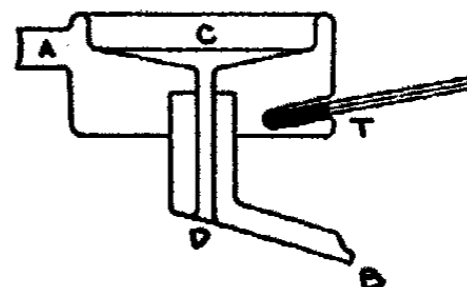

FIG. 7

The collection of three fractions in series is an advantage possible only when the vapor pressures of the first fractions in the cold flasks is lower than the vapor pressure of the hot mother liquid in the still. This may not be the case and it may be necessary to remove the involatile material. This can be done virtually by placing solid carbon dioxide around B<sup>1</sup> and B<sup>2</sup> but it is more satisfactory to disconnect and empty the flasks. The whole advantage of the triple catchment device then becomes superfluous and we

\* The heat input required by these stills is so small and needs such careful adjustment that the ordinary hotplate is not so convenient as the special coils used by the other stills.

644 may use a vessel of the kind shown in Fig. 7. The innovation here is that the floor and ceiling are protected from "implosion" by the strut, D. We have made, from ordinary Pyrex flasks, vessels of this type which will hold 500 c.c. in the distilling portion. The distillate collecting on the roof runs down the strut and emerges at B into a flask. When it is desired to pass from one fraction to the next the vacuum is relieved and the flask changed.

When every precaution has been observed to secure the highest vacuum, the rate of distillation remains limited by the rate at which molecules leave the liquid surface at the temperatures in question. This rate, according to Langmuir<sup>9</sup> must be equal to the rate of condensation from a saturated vapor at the same temperature. It is deducible from the expression:

$$W = 4.374 \times 10^{-6} \times 60. P \sqrt{M/T}$$

where  $W$  is the weight in grams of substance of molecular weight,  $M$  condensing each minute per square centimeter at a pressure of  $P$  bars at an

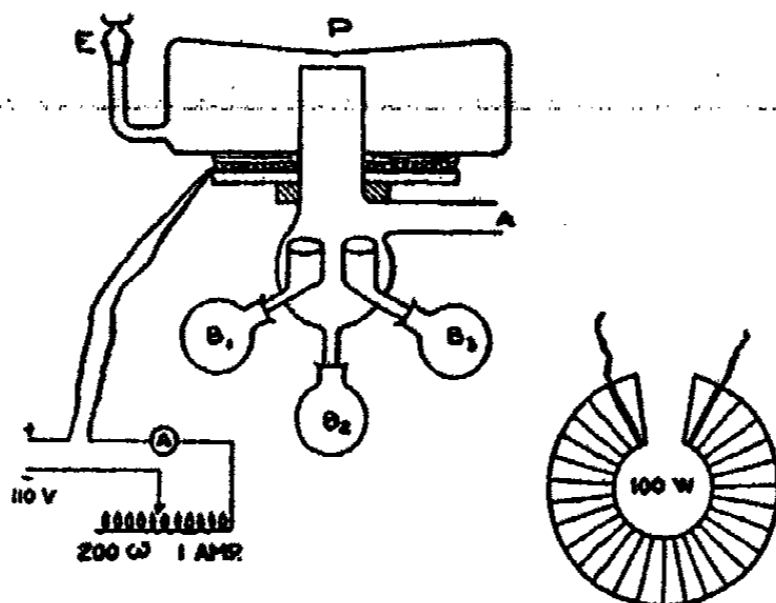

FIG. 8

absolute temperature,  $T$ . The rate at  $100^{\circ}\text{C}$ . for a substance of molecular weight of 200 can be shown to be  $25 p$  grams per minute, where  $p$  is the pressure in millimeters of mercury. Thus, an alembic of 10 cm. diameter should yield distillate at a maximum rate of  $\frac{5.2 \pi .25}{1000} = 1.96$  grams per minute, at a pressure of 0.001 mm. This agrees fairly well with the best results obtained in practice.

The relation holds good only for pressures so small that the evaporation is not sufficiently rapid to cool the surface of the liquid. Above one millimeter the deciding factor must be the rate at which heat can be passed into and through the liquid without local over-heating; and the rate at which it can be removed from the condensing surface.

This brings us to the question of securing and maintaining a sufficient vacuum. We require a good backing pump which for example may be a "Hyvac" or "Megavac" or equivalent. In conjunction with this is needed a condensation pump and at least two suitable condensation traps; lastly some matured rubber stoppers and some thick-walled, large-diameter rubber tubing. A complete assemblage is shown in Fig. 9. The distilling flask with



heater, thermometer, and receiver is supported at A and is joined to the trap, B, by a stout rubber tube, C. The large internal tube of the trap is joined to the condensation pump. The small external pipe from B passes to the McLeod gauge and a U-tube manometer. The line may well be protected by an automatic shut-off valve such as that recently described elsewhere.<sup>1</sup> The high pressure side of the condensation pump is joined to a second refrigeration trap, G, whence the line passes to the oil pump. It is useful to place a by-pass tube, E, between the far side of the trap and the high vacuum side of the condensation pump, and to place in the bend a few drops of butyl phthalate. A slight displacement of the levels shows that the pump, which may be operated by butyl phthalate instead of mercury, is working. Finally it is convenient to include two well-greased three-way stopcocks, F, just before

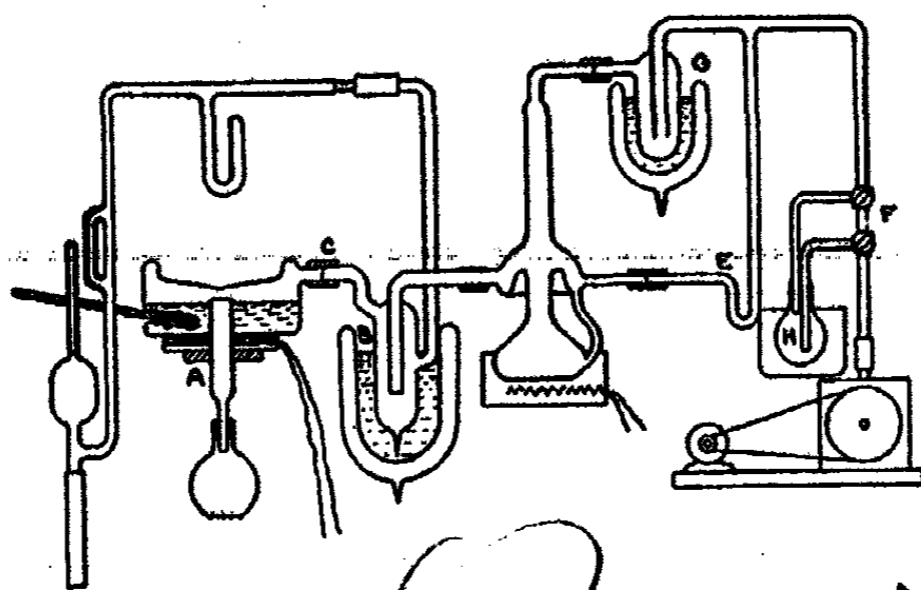

FIG. 9

the oil pump so that preliminary volatiles may be deflected into a flask cooled with ice and salt. This may be omitted if the liquid is prepared elsewhere for distillation, or if the pump is "blown out" regularly.

We will now discuss the units of this equipment.

*The Rubber Seals.*—For the most exacting work all connections may be made by fusing the glass. With practice, however, this becomes unnecessary, since matured rubber acquires a vapor pressure less than most liquids under distillation. The rubber need never be exposed in long lengths. Stout red rubber tubing containing little sulfur (as supplied, for instance, by the Central Scientific Instrument Company) is cut into convenient lengths and placed in a flask and it is evacuated over night while the flask reposes in the 80°C. oven. After this maturing treatment, the rubber is pushed 1½ inches to 2 inches over each end of glass, the ends of which are made to touch. Castor oil is rubbed over the rubber especially at the ends and is wiped off after the experiment. The same treatment and precautions apply to the rubber stoppers. Rubber prepared in this manner is ready for use at any time and should not require reheating.

*The Vapor Traps.*—It must be emphasized that the condensation pump cannot work at its full efficiency unless the lead-in tube on the high-vacuum side is at least as wide bore as the pump itself.<sup>4</sup> Alternatively if the size of

<sup>666</sup> the tubing is limited by other considerations, a quite miniature pump can be used.\* We recommend a bore of about 2 cm. which demands that the trap, B, shall be of wide diameter. To prevent choking the entrance to the trap should always be by the side arm, which is kept well above the level of refrigerant. The lead tubes of trap, G, may be smaller because the pressure here is higher. Refrigerant should never be placed in all the traps at the beginning of distillation. The flask, H, should be surrounded first with ice and salt, and should be shut out of the pipe line when vapor ceases to condense. Trap, G, may now be packed with solid carbon dioxide and the distilling vessel watched for signs of sublimation. The trap, B, should never be cooled unless the pressure given by the McLeod gauge is less than 0.01 mm. Below this pressure it is well to freeze out butyl phthalate and other vapors so that the mean free path in the still may become large. *If the refrigerant is applied at this place too early*, volatiles may be condensed at a high pressure which will evaporate later at a low pressure, in spite of the reduction in temperature, and it may take hours or even days to rid the apparatus of contamination.

*The McLeod Gauge.*—The McLeod gauge will often be contaminated with condensable vapors and will not give a true reading of pressure in the pipe lines or particularly in the hot still. It will, however, give a fairly accurate indication of the residual gas and this, as we have shown, is often the critical factor.

*Temperature Control.*—It has been found quite untrustworthy to express the boiling points of liquids in these stills as a function of the pressure at which they begin to sublime. The thermometer is useful merely to follow the progress of heating. In general, the vapor pressure doubles for every rise of from 6°C. to 10°C. The evolution of decomposition products on the other hand may increase a hundred-fold for a similar rise in a critical temperature region. The decomposition products hinder distillation and we have often encountered the paradox that sublimation increases as the temperature is lowered. The temperature of distillation should be noted carefully as a guide to future work but no conclusion as to the boiling point:pressure relation should be drawn.

*Breaking the Vacuum.*—Dissolved gases and volatile solvents prevent a sufficient vacuum for distillation being obtained for so long a time on first treating the liquid that the operator might be loath to admit air for changing the receivers. Actually it is found that distillation is resumed rapidly after re-evacuation because only a negligible quantity of air dissolves in the hot liquid during the few minutes of interruption.

*Preparing the Liquid.*—Much frothing and preliminary heating may be avoided in the still if the liquid is treated first for the removal of solvents. Air or nitrogen may be blown through for a couple of hours while the liquid is held in a flask warmed in a basin of water. The warmed liquid may equally well be treated by suction from an ordinary filter pump.

\* See later for description of miniature pump.

*Blowing out the Oil Pump.*—The oil pump draws in volatile solvent<sup>667</sup> and air on the suction stroke and condenses the solvent portion in the oil during compression. The oil may of course be rectified by distillation, but it may often more simply be "blown out." A rubber tube is so clipped on the intake that air is sucked in sufficiently to discharge bubbles of about 10 c.c. in volume under the oil. The pump is run all night in this manner and thereby subjected to about maximum load. The oil becomes quite hot and the solvent is blown off. In the morning the pump is run with the tube completely closed and becomes ready for use in about an hour.

*Preparing a High-Grade Pump Oil.*—There seems no mechanical reason why an oil pump should not exhaust to less than 0.001 mm. of mercury if the oil has a vapor pressure less than this amount. The best commercial pump oils measured after continued refluxing in our tensimeter indicated a vapor pressure of about  $10^{-6}$  mm. at room temperature. The apparent vapor pressure of the pump oil is due to the products of cracking which are always present from the distillation during manufacture. They confer, in fact, a definite smell. Redistillation under vacuum in an ordinary distilling flask is no remedy, for it generates as many products as it removes. When, however, the oil is fractionated in a sublimation still, a middle portion of golden yellow color is obtained entirely free from odor which exhibits no readily measurable vapor pressure at ordinary temperature. The material is recommended for pump fillings when a condensation unit is not available. We have not yet had an opportunity of determining the lower limit attainable with the refined oil.

Perhaps the best guide to using a sublimation still will be furnished by an extract from our notes covering an actual distillation. Tri-benzyl citrate was prepared by condensing citric acid and benzyl alcohol with some hydrochloric acid in the presence of much xylene. The water from the reaction was separated and the benzyl alcohol mostly removed by pre-treatment under vacuum. After cooling, the resulting crude white mass was remelted and 200 c.c. introduced into the still. It was then warmed to 50°C. while much air was thrown off. Distillation commenced and 50 c.c. of a straw-colored fluid collected after which the transfer stopped and showed no tendency to continue during two hours. The receiver was then emptied of distillate, which proved to be benzyl alcohol, and was replaced by a clean one. The temperature was raised to 110°C. and pumping continued for twelve hours but no distillation took place. The temperature was therefore lowered to 80°C. and the high-pressure trap (G) was cooled. No sublimation occurred for a further eight hours, when suddenly the material began to come over rapidly. In an hour or so 90% had passed into the receiver where it eventually set to a white crystalline solid. The McLeod gauge registered no difference in pressure between the periods just before and during final distillation, showing that the inhibiting impurity was condensable at atmospheric pressure. We have not found any reference in the literature to the distillation of tri-benzyl citrate.

668

### The Uses of High-Bolling Organic Liquids

We have distilled a number of materials in the above manner and have determined their vapor pressures,<sup>10</sup> surface tensions, their capacity for dissolving air,\* and their effect on the mercury meniscus.<sup>11</sup> About this time there appeared in *Nature*<sup>12</sup> a note by C. R. Burch on the use of heavy hydrocarbon oils to replace mercury in the Langmuir condensation pump. Dr. C. E. K. Mees suggested that we try the liquids, about which we had now collected so much data, in the hope that some might show an advantage over mercury.

N-di-butyl phthalate, from other evidence, seemed the most likely fluid and was accordingly tried; with success. Butyl phthalate has a vapor pressure one hundred times less than mercury at room temperature and the di-

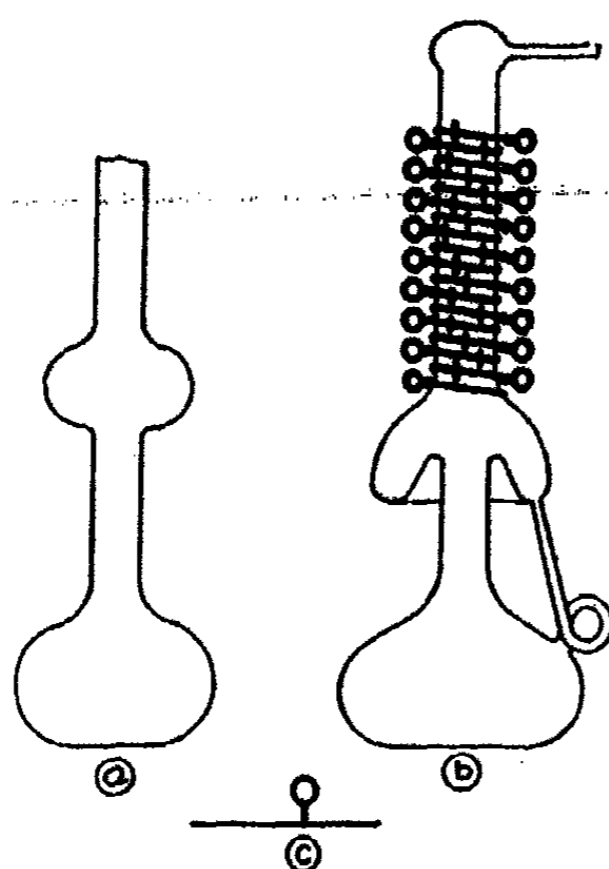

FIG. 10

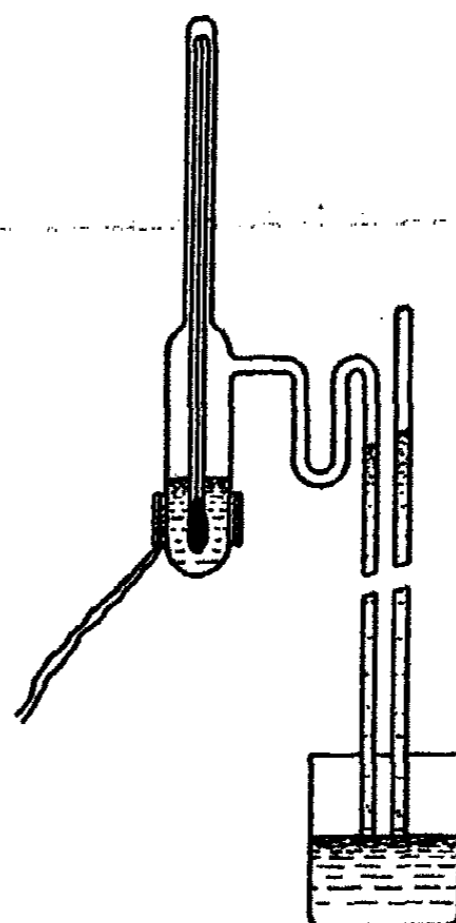

FIG. 11

vergence increases as the temperature falls. We were able to build miniature air-cooled pumps which would utilize the phthalate\*\* and run them in conjunction with the Hyvac oil pump. This pump and others are being detailed, with charts of their performance, elsewhere,<sup>13</sup> but a useful laboratory pattern may be described here. The butyl phthalate gives the same maximum speed of exhaust as mercury, but is more sensitive to wattage input and requires a slightly lower backing pressure. The great advantage is its low vapor pressure and the elimination of mercury vapor, enabling a trap to be omitted for most chemical operations. The pump is extremely simple. A glass tube, 15 mm. internal diameter, is blown into two bulbs as shown in Fig. 10. The upper bulb is pushed in to yield an alembic, taking care that the jet is about 7

\* See page 652.

\*\* Mercury works equally well in the miniature pump.

mm. away from the receiver. The annulus is connected to the lower bulb<sup>649</sup> by a slender trapped pipe. Stout copper wire twisted into spiral loops at frequent intervals is wrapped around the stem in close formation. The loops are so hammered that the points of departure are not thicker than the parent wire. The copper is then blackened with dilute ammonium sulfide. A heater absorbing some thirty or forty watts at seventy volts is then wound on an asbestos horseshoe and packed against the bottom. Thirty cubic centimeters of butyl phthalate is poured in and the pump run in vacuo with the heater connected with an adjustable resistance to the 110-v. mains. When the best wattage input is determined, a small resistance is wound equal to that of the adjustable resistance for which it is substituted in series with the heater. A switch is provided to short circuit the subsidiary resistance during the warming up period.

These little condensation pumps are so light and convenient that they may be included as boosters in all manner of vacuum apparatus. They may be suspended in the glassware train without special support. Cooling may be assisted by a long paper chimney or by a fan. The best wattage input varies with the cooling. With no forced draft, a small input gives as good a speed of exhaust as a larger input with a well-cooled pump. The only advantage of the greater cooling is that exhaustion commences at a higher backing pressure. We use uncooled pumps in most of our own work. Besides di-butyl phthalate we have tried:

di-benzyl phthalate	ethyl oleate
butyl benzyl phthalate	"Nujol"
n-amyl phthalate	vacuum pump oil
iso-amyl phthalate	tri-cresyl phosphate
butyl stearate	di-benzyl malonate <i>etc., etc.</i>
methyl oleate	monochlophthalane, <i>etc.</i>

Butyl benzyl phthalate is the only member equal to butyl phthalate in speed and reliability. It has a lower vapor pressure but is much more expensive. All the other materials are slower or of no use at all. The superiority of the butyl phthalate is evidently due to its stability. A sample was sealed in a small electrically warmed tube under torricellian vacuum (Fig. 11). and the fall of the pendent mercury column plotted with time. The phthalate refluxed gently at 130°C., maintaining vapor halfway up to the tube. A little gas was given off during the first day and was withdrawn, resealing the apparatus. Thereafter the pressure rose at about a millimeter a week, the rate increasing as the temperature of distillation was raised.

If the products of decomposition had a molecular weight equal to carbon dioxide, this would give, for the sample used and under these vacuum conditions, a half period of decomposition of 36,000 years; supposing always that no change took place in the liquid phase. When the phthalate was boiled in a tube containing a piece of brightly polished steel, no decomposition occurred for 24 hours but later the liquid became dark gray. Phthalic anhydride sublimed on the upper parts of the tube and quantities of gas were evolved. The phthalate is not suitable for use in metal pumps.

<sup>650</sup>The other liquids listed continually evolved minute quantities of gas on boiling. Benzyl butyl phthalate and iso amyl phthalate could be boiled for a day without appreciably relieving the vacuum, but the stearates, oleates, and malonates, and the higher paraffins, all showed continued decomposition. Evidently these bodies fail to give good pumping action because they are burdened with the task of blowing off their own waste products. The high-boiling paraffin hydrocarbons consist of many isomers. It is possible that some of these are less stable than others, and may be eliminated with long boiling. We tried the straw-colored fraction from the sublimation of vacuum pump oil and found a very poor efficiency in the condensation pump. After two days' use, however, it exhausted as well as butyl phthalate. It did not attack iron and could be used in a metal pump. On the other hand, it charred more readily than the phthalate and would consequently entail more frequent cleaning of a pump than mercury. The following summary may prove useful:

Fluid used in Pump	Behavior	Vapor Pressure at	
		25°C.	0°C.
Mercury		$2.3 \times 10^{-6}$	$2.4 \times 10^{-7}$
Butyl phthalate	Attains maximum efficiency a few minutes after commencement of boiling.	$7.8 \times 10^{-6}$	$3.5 \times 10^{-6}$
Butyl benzyl phthalate	Requires boiling for some hours initially. Works well in few minutes in subsequent operations.	$6.2 \times 10^{-6}$	$2.6 \times 10^{-7}$
Heavy hydrocarbon	Requires two days initial boiling. Chars on continued use.	$2.9-4.0 \times 10^{-6}$	$1.2-2.1 \times 10^{-7}$

*Lubricants for the Mercury Meniscus.*—When a drop of mercury is splashed on glass it breaks into minute drops which, in spite of their great comparative weight, fail to move when the glass is tilted. Both clean and dirty mercury stick to glass. The adhesion is in evidence although less pronouncedly when mercury moves in a glass tube. The meniscus flattens as the mercury ebbs and bulges as it flows. The angle of contact and the actual height of the crown vary for a given head with the last direction of movement and with the nature of the surface film. It would be a distinct advantage for physical measurements, and for many mechanical devices, if the mercury could be made to wet glass and thus assure a contact angle of zero—or else could be so perfectly insulated from the glass that it maintained an angle of 180°. We have found that within limitations the latter condition can be secured.

Very clean mercury in vacuo sticks to glass because of the intrinsic attraction of mercury and glass. The surface of the mercury, since it has no film other than that of the boundary mercury atoms, which exhibit temporarily the special properties conferred by their position, is interchangeable with the bulk of the liquid. Work done in pulling the mercury away from the glass on one side of the globule should be returned by the approach of other portions on the other side. When there is a layer of oxide, whether one or many molecules thick, the layer is not interchangeable with the liquid bulk, and movement must rupture the layer. This is the usual practical condition. Mercury in a glass tube must be considered "sheathed over" the meniscus and far down the cylindrical portion adjacent to the glass walls with a layer of oxide. On receding this layer must be ruptured and crumpled against the force of surface tension. A supernatant layer of organic liquid facilitates the passage of mercury in at least three ways. It may assist the crumpling of the film; it may insulate the film from the glass and allow it to move without crumpling; and it may dissolve the film altogether. Almost any true lubricant<sup>14</sup> will perform the first function. For the second it is necessary to add to the fluid a substance which is adsorbed so heavily to the glass that the film does not adhere. Mercury di-p-tolyl in butyl phthalate, or mercurous nitrate in water are both effective. Complete solution of the film may be secured by free halogen in a suitable solvent; by powerful reducing agents; and by the mercaptans and allied sulfur bodies.<sup>15</sup> No mercaptan has

been found which does not ultimately yield a second film of mercury sulfide, but the film appears excellently lubricated against the glass.

A lubricant for mercury in high-vacuum apparatus must have a negligible vapor pressure.

For the most exacting requirements where low pressure is more important than perfect lubrication we recommend di-benzyl phthalate saturated with mercury di-p-tolyl. When the exhaustion is continually performed, the same solvent, or di-butyl phthalate, containing 1-5% phenyl hydrazine (base, not hydrochloride), gives quite perfect lubrication. A little nitrogen is evolved and perhaps some benzene and water, but in such small amounts that they pass unnoticed to the pump. For experiments lasting a day only butyl phthalate or higher boiling solvent containing one per cent of thioacetanilide may be used.

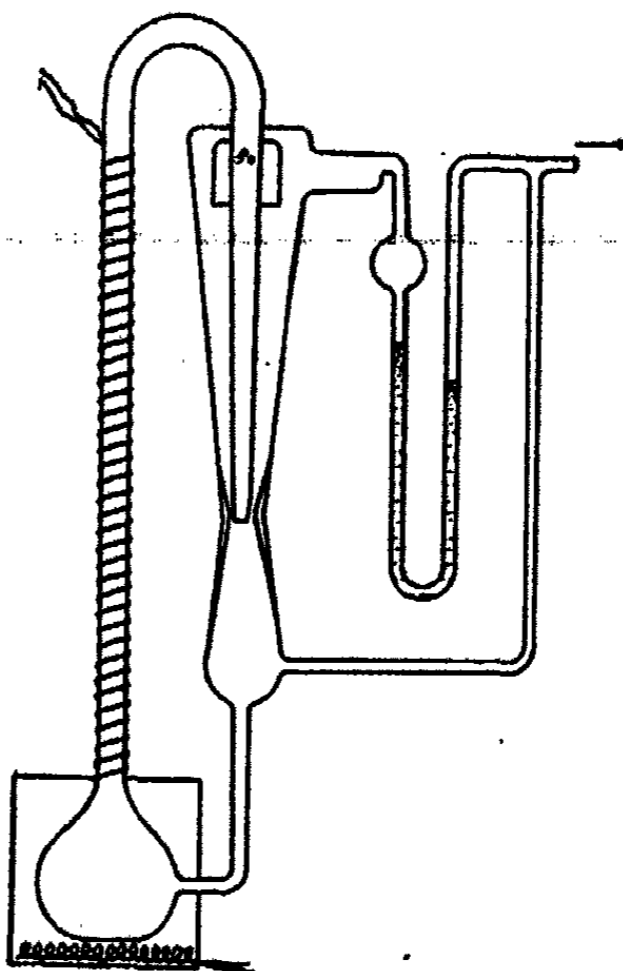

FIG. 12

Any of these fluids allowed to float to a depth of a millimeter, above the column in a mercury barometer will allow the meniscus to move without sticking or without changing shape. Readings with the cathetometer may be made with extreme accuracy. The fluids all have the disadvantage, not shared by mercury, that they dissolve air and other gases. The solubility by volume of air at 20°C. is given in the accompanying table.

Substance	Solubility
Ethylene glycol	4.7%
Tri- <i>o</i> -cresyl phosphate	5.4
Alpha chlor naphthalene	7.2
Alpha chlor naphthalene (crude)	12.0
Triacetin	9.4
"Nujol"	10.1
Ethyl ether of ethylene glycol	11.7
Methyl oleate	12.4
Ethyl oleate	14.0
Butyl stearate	18.1
Iso-amyl phthalate	8.9
N-di-butyl phthalate	9.0
Butyl benzyl phthalate	9.3
Butyl terephthalate	9.7
Methyl glycol phthalate	11.6

This solubility of gases renders the fluids unsuitable for use in gasometers, or manometer tubes, unless, in the latter case, precautions are taken to remove gases liberated in the high vacuum limb. A very delicate manometer sensitive to at least 1/100 mm. can be made from a two-stage condensation pump, using mercury and a U-tube filled with dyed phthalate (Fig. 12).

Both ends of the manometer tubes are open to the source of pressure change and sudden admission of air causes no harmful return of the liquid column. When the manometer is connected to the vacuum line this line acts as the backing pump of the two-stage mercury pump. A substantially perfect vacuum is produced in one limb while the pressure to be measured depresses the liquid in the other. Gases dissolved in the phthalate column are removed immediately as they leave either meniscus.

#### Summary

The replacement of mercury by high-boiling organic liquids in certain physical operations is described.

A method of procedure for high vacuum distillations is outlined.

A condensation pump operating from organic liquids is described.

An explanation is advanced for the adhesion and sticking of mercury in glass tubes, and a series of lubricants are named which prevent the adhesion.



Acknowledgment 653

In conclusion, the authors wish to express their heartfelt thanks to Dr. S. Dushman for assistance in interpreting the equations for gaseous flow. Dr. Dushman's book on high vacua has been consulted throughout this work. Thanks are also due to the General Electric Company for facilities placed at their disposal.

## References

- <sup>1</sup> J. Opt. Soc. America, 18, 305 (1929).
- <sup>2</sup> J. Opt. Soc. America, 18, 69 (1929).
- <sup>3</sup> "Synthetic Organic Chemicals" Vol. II, No. 3, Feb. (1929). Eastman Kodak Company, Rochester, N. Y.
- <sup>4</sup> See Langmuir: J. Franklin Inst. 182, 727 (1916).
- <sup>5</sup> Ann. Physik, 28, 76 (1909).
- <sup>6</sup> Phys. Rev., 8, 149 (1916); Knudsen: Ann. Physik, 47, 697 (1915).
- <sup>7</sup> See Dushman: "High Vacuum," General Electric Review Press p. 30, *et seq.* (1922).
- <sup>8</sup> Dushman: loc. cit. p. 13.
- <sup>9</sup> Dushman: loc. cit. p. 18.
- <sup>10</sup> Phys. Review, 2, 329 (1913).
- <sup>11</sup> A Low-Pressure Tensimeter. J. Phys. Chem., 34, 627 (1930).
- <sup>12</sup> J. Opt. Soc. America, 19, 190 (1929).
- <sup>13</sup> Nature, Nov. 10, p. 729 (1928). Since assembling this article a paper by C. R. Burch has appeared (Proc. Roy. Soc., 123A, 271 (1929), covering substantially the same subject material. The practical methods of the present writer differ considerably from those of Burch and the present contribution is offered without further apology.
- <sup>14</sup> Rev. Sci. Instruments, 1, 140, March (1930).
- <sup>15</sup> See Hardy and Doubleday, Proc. Roy. Soc. 100A, 500 (1921); 101A, 489 (1922); 104A, 25 (1923); 108A, 1 (1925).
- <sup>16</sup> Suggested to the authors by Dr. S. E. Sheppard of this laboratory.

## THE MANIPULATION OF JELLY STRENGTH-TESTING APPARATUS

BY GENE SPENCER

The criterion of comparison of jelly strength, as measured by the apparatus<sup>1</sup> described in the first paper, is, the number of grams which are required to overcome the resistance of the jelly to cutting, Fig. 1.

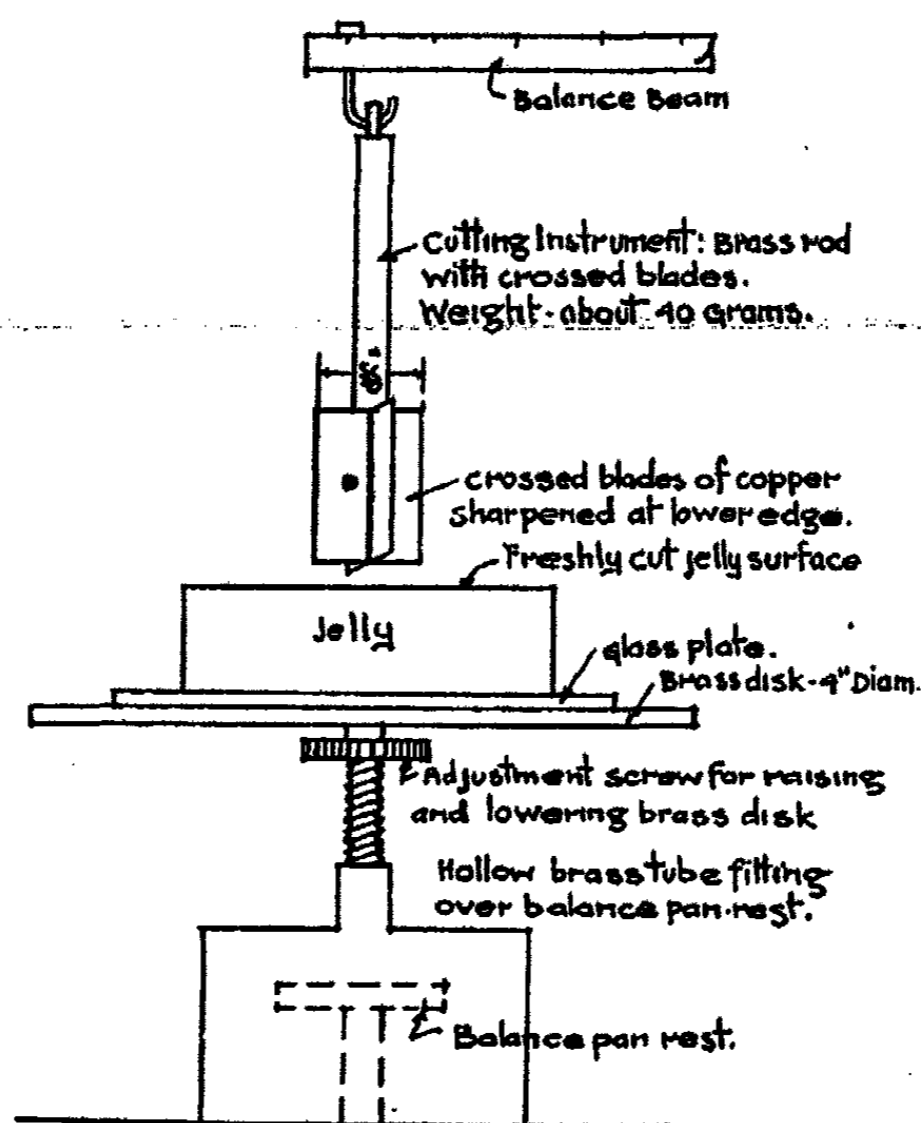

FIG. 1

The cutting instrument is substituted for the left balance pan and counter-balanced in the usual way.

A freshly cut surface of the jelly is brought carefully into contact with the cutting edge of the crossed blades of the cutting instrument. This is accomplished by means of the adjustment screw attached to the disk upon which the jelly holder rests.

A weight, for instance a 2 gram weight, is removed from the balance pan on the right and the beam released. Thus a cutting force of 2 grams is exerted on the surface of the jelly. If the pointer moves across only a few divisions of the scale and then stops, it indicates that a 2 gram cutting force is not enough; if it moves off the scale, it is too much. In either case new trials are

<sup>1</sup> J. Phys. Chem., 33, 1987 (1929).

made, on fresh spots of the surface, until the *minimum* weight is found, the removal of which from the balance pan will cause the pointer to move steadily to the last scale division. The distance which the blades penetrate the jelly, for the balance used here, is about one-third of an inch.

Check determinations on the same jelly by different operators are found to vary with the strength of the jelly, thus:

TABLE I

Jelly strength	Variation
0.5 - 5.0 grams	0.5-0.2 grams
5.0-10.0 "	0.2-0.5 "
10.0- "	0.5-1.0 "

The significance of strength in terms of "domestic jelly" is shown in the following table:

TABLE II

Source of Jelly	Strength
Bancroft's Lab. 55% Sugar, 0.5% Pectin 1 cc N HCl/100 grams jelly	5.2 grams
Certo Corporation (Standard Jelly)	
1st Sample	2.3 grams
2nd "	3.1 "
Student Home Economics Lab.	3.0 "
<i>Cornell University</i>	

## THE INFLUENCE OF TEMPERATURE UPON "RAPID" COAGULATION OF GOLD HYDROSOL

BY PATRICK JOHN REES BUTLER

The present work is a continuation of that performed by Miss Davies<sup>1</sup> in this laboratory. Before dealing with the experimental results, it is necessary to recall very briefly Smoluchowski's treatment, which is employed throughout as a theoretical basis.

Two regions of coagulation have been formulated by Smoluchowski,<sup>2</sup> namely, a region of "rapid" coagulation, corresponding to complete electrical discharge of the particles, all collisions in this region being effective, and also a region of "slow" coagulation, in which the particles are only partially discharged and electrical forces, due to the residual charge on the particles, are of importance. In the "rapid" region, the concentration of electrolytes, provided that it is sufficient to ensure "rapid" coagulation, is unimportant; in the "slow" region, the speed of coagulation is dependent on the concentration of the electrolyte. From probability considerations, Smoluchowski deduced a series of equations for different stages of coagulation. The simplest equation, which is the one giving the rate of disappearance of *primary* particles, is:—

$$v_1 = \frac{v_0}{(1 + \beta t)^2}$$

Where,  $v_0$  = the no. of primary particles present at zero time,

$v_1$  = the no. of primary particles present after time  $t$ ,

$\beta$  = Smoluchowski Constant =  $4\pi D\rho v_0$

Where,  $\rho$  = radius of attraction of the particle,

$D$  = Diffusion constant, given by Einstein's eqn.,

$$= \frac{RT}{N} \cdot \frac{1}{6\pi\eta r}$$

In which,  $R$ ,  $T$  and  $N$  have the usual significance,

$\eta$  = viscosity of the medium

$r$  = radius of the particle.

Several investigators<sup>3</sup> have tested the validity of this equation. It is concluded from the results of their investigations that the theory holds for a region closely approximating to "rapid" coagulation but for the region of "slow" coagulation it is inapplicable in its original form.

<sup>1</sup> Ann Davies: J. Phys. Chem., 33, 274 (1929).

<sup>2</sup> Smoluchowski: Z. physik. Chem., 92, 129 (1917).

<sup>3</sup> Zeigmondy: Z. physik. Chem., 92, 600; Westgren and Reitstötter: 750 (1917); Kruyt and Arkel: Rev. Trav. chim., 39, 656 (1920); Hatschek: Trans. Faraday Soc., 17, 499 (1921); Mukherjee and Papaconstantinou: Phil. Mag., (6), 44, 305 (1922); Kruyt and Arkel: Kolloid-Z., 32, 29 (1923); Anderson: Trans. Faraday Soc., 19, 623 (1923); Wiegner: Z. Pflanzenernähr. Düngung B., 11A, 185 (1928); Maud Garner: J. Phys. Chem., 30, 1401 (1926).

The equation is used in the present work to provide a quantitative method for comparing the velocity and extent of coagulation. The concentration of electrolyte employed is sufficient to ensure "rapid" coagulation, so that use of the equation is justified.

*Ageing and Thermo-senescence of Gold Sol.*

The phenomenon of ageing is found in various forms throughout colloid chemistry. The term is usually applied to those changes in properties (both physical and chemical) of a colloid which take place on keeping a sol for any length of time at room temperature. The *temperature* restriction is, however, purely arbitrary. Several theories have been advanced to account for this effect in individual cases but no general law seems to be followed and it is difficult to relate the behaviour of different sols when undergoing ageing. It is uncertain whether ageing is the same process in all cases, the term being used quite loosely. It has been found in this laboratory that marked changes are brought about by maintaining a sol for a period of time at an elevated temperature. This effect has been termed thermo-senescence (cf. Miss Davies: loc. cit.). In Miss Davies' experiments the behaviour of gold sols when maintained at 80°C for various time periods was examined. She found, on subsequent coagulation of the sol at that temperature or at a lower temperature in the "slow" region,\* that the values of  $\beta$  fell with the time of maintenance of the sol at 80°C until, eventually, a constant limiting value of  $\beta$  was obtained. It was found that maintenance of the sol at 80°C for three hours was sufficient for this purpose.

Miss Davies also showed that the thermo-senescence effect was irreversible and that on cooling to 25°C and reheating to 80°C, no further change in the stability of the sol was observed. The effect of maintaining the sol at an elevated temperature for a given period of time is to render it less coagulable when it is subsequently exposed to the influence of electrolytes. Miss Davies has suggested that this thermo-senescence effect is due to a contraction of each individual sol unit with consequent increase in the charge density and therefore decrease in coagulability. Virtually the same suggestion has been made by Thiessen, Thater and Kandelaky<sup>4</sup> to explain the increased stability with decreased particle size in the case of gold sol. Such an effective increase in original charge would manifest itself in the expected sense upon subsequent coagulation by electrolyte, the concentration of which was only sufficient to bring about "slow" coagulation. The thermo-senescence of the sol, in fact, made its subsequent "slow" coagulation still slower. Clearly, however, if sufficient electrolyte be employed to discharge all the sol particles completely, i.e. if rapid coagulation be realised, the explanation put forward by Miss Davies, *if adequate*, would lead us to expect that the phenomenon of thermo-senescence would not manifest itself when looked for by the

\* i.e., the concentrations of coagulating electrolyte employed in Miss Davies' experiments were insufficient to cause "rapid" coagulation.

<sup>4</sup> Thiessen, Thater and Kandelaky: *Z. anorg. allgem. Chem.*, 180, 11 (1929).

method of "rapid" coagulation. It was therefore of importance to carry out measurements in the "rapid" region with material which had been maintained at an elevated temperature for different periods of time in order to see whether the thermo-senescence effect still manifested itself or not. To obtain reliable results for coagulation speeds necessarily high, a special form of apparatus had to be employed. This is described in the experimental section.

Briefly, the results of numerous experiments show, without exception, that even under the conditions of "rapid" coagulation the phenomenon of thermo-senescence still persists, that is, the value of  $\beta$  obtained by a "rapid" coagulation subsequent to maintaining the sol for different time periods at the high temperature, varied with these periods and finally reached a limiting value (independent of further pre-treatment) just as Miss Davies found for "slow" coagulation. It is evident, therefore, that whilst the suggestion made by Miss Davies regarding increase in charge density during thermo-senescence may be, and probably is, correct, some other change is occurring during the maintenance at the high temperature which is of such a nature that it also renders the sol units less coagulable even when they are subsequently deprived completely of their charge. It has occurred to the writer that this additional effect may have its origin in an alteration (namely a decrease) in the value of  $\rho$ , the radius of the sphere of attraction around each sol unit postulated by Smoluchowski, this decrease in  $\rho$  being due to a decrease in the actual physical dimensions of the sol unit as a consequence of being maintained at the high temperature. It will be recalled that the sphere of attraction according to Smoluchowski is such that within it the attraction is so strong that any other particle entering it is firmly held, and unless the particle does enter it, no coalescence will occur even though both particles are electrically discharged.\*

The suggestion that the physical dimensions of the sol units decrease by being maintained at a high temperature is not improbable in view of the fact demonstrated by Zsigmondy<sup>6</sup> that colloidal gold micelles of ageing become more crystalline.

In the present paper it is not proposed to deal in any further detail with the phenomenon of thermo-senescence, since the immediate point of interest is the influence of temperature upon the actual rate of coagulation in the "rapid" region. It has been necessary, however, to refer to the existence of thermo-senescence since it is evident that reliable values of  $\beta$  even in the "rapid" region can only be obtained with material which has been pre-treated in the manner described.

\* It may be pointed out that the suggestion just made regarding the alteration in  $\rho$ , as well as Miss Davies' suggestion of an alteration in the electrical density (applicable only to the "slow" coagulation conditions) are both dependent upon a decrease in the physical dimensions of the sol units with rise in temperature. The two suggestions made are in agreement with two of the fundamental postulates made by Smoluchowski, namely, electrostatic repulsions and van der Waals attractions between the sol units.

<sup>6</sup> Zsigmondy: Kolloidchem. Beihefte, 19, 441 (1924).

### Experimental Technique

The gold sols were prepared by the 'acetone' method already employed by Miss Davies (*loc. cit.*). The sols were dialysed in collodion membranes against distilled water for three days, the water being changed twice a day. The conductivity of the dialysed sols was  $1.2 \times 10^{-6}$  mhos. All solutions were made up with redistilled water obtained by the redistillation of ordinary distilled water from a silver lined copper vessel. All vessels and containers with which the sols came in contact were of quartz. They were carefully cleaned before use with alkali, alcohol-nitric acid mixture, distilled water and finally steamed out for five minutes with steam from redistilled water.

For use in the region of "rapid" coagulation, the sol was diluted with redistilled water. The *original* sol, after dialysis, contained about 56 mgs. of gold per litre. The dilution employed in the present investigation was 1

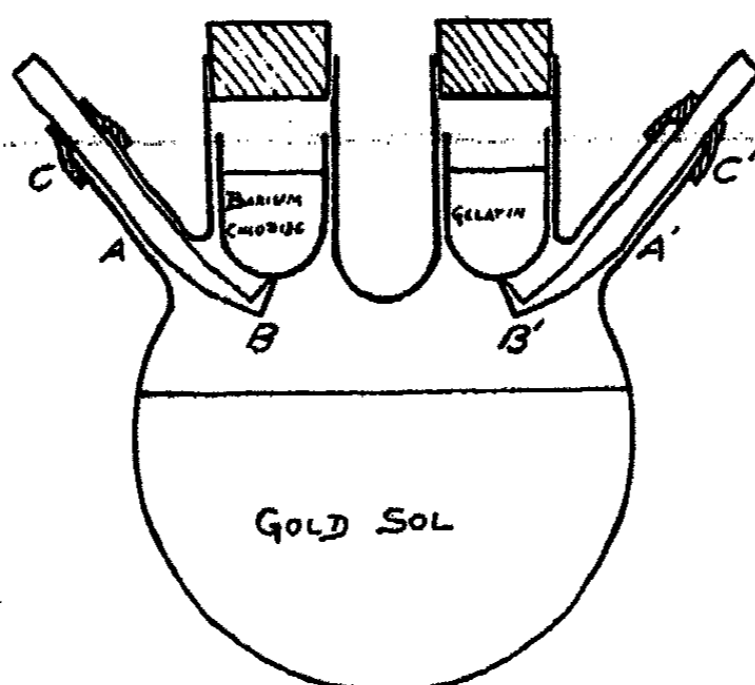

FIG. 1

part of sol to 3 parts of redistilled water, this giving a concentration of gold in the diluted sol of 14 mgs. per litre. It has been shown by Ghosh and Dhar<sup>6</sup> that colloidal gold follows the general dilution law, i.e. the greater the concentration of the gold sol, the greater is the electrolyte concentration required for coagulation. The dilution therefore tends to ensure rapid coagulation. However, owing to the increased spatial separation of the colloid particles, the speed of colour change is diminished and therefore made easier to follow. With this dilution and a concentration of  $\text{BaCl}_2$  solution of 0.00664 N (in the sol) as coagulant, the colour change from 100% red to 100% blue was complete in 45 seconds at 80°C. It was found by experiment that the value of  $B$  obtained for this concentration of  $\text{BaCl}_2$  was the same, within the experimental error, as the value obtained using 0.00996 N and 0.01328 N  $\text{BaCl}_2$ . That is, a concentration of 0.00664 N is sufficient to ensure "rapid" coagulation.

*Apparatus.* In order to ensure more controllable conditions than those obtained by Miss Davies, a special type of flask was designed. These flasks

<sup>6</sup> Ghosh and Dhar: *J. Phys. Chem.*, 31, 187 (1927).

are an adaptation of a type used by Walton<sup>7</sup> in Bredig's laboratory. Only one reactant had to be added in that case, but in the present investigation, two have to be introduced. The design is as follows:—

The flasks are of quartz, round-bottomed and possessing two necks. Each is fitted with two side tubes (A,A'). Down these side tubes glass rods pass, just small enough to fit easily in them. A bend at the end of each rod (B,B') supports a small quartz tube. The rods are held in place by stout rubber tubing (C,C'). The necks of the flasks are closed with rubber stoppers. By the use of these flasks the time of coagulation can be accurately controlled and there is no evaporation,\* the whole 'ageing' and coagulation process taking place in the flask. The method of use is as follows:—

100 cc. of the diluted sol is placed in the sterilised quartz flask; the small quartz tubes are placed in the necks of the flask, held in place by the glass rods in the side tubes. In one quartz tube, 2cc. of a 0.332 N BaCl<sub>2</sub> solution is placed. This, on being eventually added to the sol, gives a concentration of 0.00664 N BaCl<sub>2</sub>. In the other tube is placed 2cc. of a 2% gelatin solution. This, on addition to the coagulating sol, prevents further coagulation, as recommended by Zsigmondy.<sup>8</sup> The rubber stoppers are placed in the necks and firmly pushed in, the flasks then being suspended in the thermostat. It has been found that the flasks have to be immersed for half an hour at 80°C before they attain this temperature. The rod, B, supporting the tube containing the barium chloride solution is turned through 90° (this is made possible by the elasticity of the rubber tubing) thus allowing the tube to fall into the sol at a known moment of time to start the coagulation process. The flask is shaken for one second after addition of the electrolyte to ensure mixing. The arbitrary time allowed for coagulation is such as to give a convenient colour change. At the end of this time, the rod, B', supporting the tube containing the gelatin solution is turned, allowing the gelatin to fall into the sol, thereby arresting the coagulation process. The flask is then removed and allowed to cool. In all cases the flasks are allowed to cool overnight, the determination of the percent. red being carried out on the following day. In this way the rates of cooling for all samples are approximately the same.

The coagulation of colloidal gold involves a colour change from red to blue, it being assumed that the red colour is due entirely to primaries. The percentage red colour remaining at any time, which is proportional to the amount of uncoagulated sol, was determined by Hatschek's colorimetric method.<sup>9</sup> A full description of the apparatus is given in Hatschek's paper, but for use with the dilute sols employed when coagulating in the "rapid"

<sup>7</sup> Walton: *Z. physik. Chem.*, 47, 185 (1904).

\* The necessity for the prevention of evaporation was demonstrated by Miss Davies in the work referred to. She found that when any evaporation occurred, although this was small, the values of  $\beta$  showed an increase with the time of maintenance of the sol at 80°C.

<sup>8</sup> Zsigmondy: *Z. physik. Chem.*, 92, 600 (1917).

<sup>9</sup> Hatschek: *Trans. Faraday Soc.*, 17, 499 (1921).



region, a modification was introduced. This took the form of a second "standard" cell, placed on top of the cell containing the sol whose percent. red was required, so that the sol of unknown percent. red is matched with a standard percentage of red above and below. In this way more accurate matching was possible, the error being about  $\pm \frac{1}{2}$  a scale division (corresponding to  $\pm 0.62\%$  red), as compared with 1-2 scale divisions (1.2%-2.5% red) when using the original method.

Since climatic conditions in this country prevent the permanent use of "diffuse daylight from a bright sky," specified by Hatschek, the source of illumination employed was an 800 C.P. lamp the light from which passed, after reflection from a white screen, through a piece of matt glass before entering the apparatus, this ensuring sufficient diffusivity. This method was employed by Miss Garner.<sup>10</sup>

The Hatschek cells were washed with a jet of warm NaOH solution, soap and water and, finally, with distilled water. They could not be steamed owing to the low melting point of the adhesive used in the preparation of the cells.

#### *Variation of $\beta$ with Coagulation Time.*

According to Smoluchowski's theory, in the region of "rapid" coagulation the values of  $\beta$  should be constant and exhibit no variation with the time allowed for coagulation. To verify this samples of sol were coagulated for various coagulation times at 80°C, following the procedure already described. Prior to initiation of the coagulation process the sols in all cases were maintained at 80°C for three hours. The results are given in Table I. The table as a whole represents the results of seven independent experiments, each of them duplicated.

TABLE I

Coagulation Time	Percent. red	$\beta$	Coagulation Time	Percent. red	$\beta$
10 secs.	81.25	0.0110	30 secs.	30.625	0.0269
15 "	62.5	0.0177	35 "	26.25	0.0272
20 "	43.75	0.0256	40 "	25.0	0.0250
25 "	37.5				

It is seen from the table that the values of  $\beta$  obtained when the sol is coagulated for 10 secs. and 15 secs. are low compared with the values of  $\beta$  obtained when a longer time is allowed for coagulation. In view of this, a time period of 20 secs. was chosen in the subsequent experimental results recorded.

On addition of the electrolyte to the sol, the flask was in all cases shaken for one second. Continuous shaking was not undertaken, since it has been shown by Freundlich and Kroch,<sup>11</sup> and Freundlich and Loebmann,<sup>12</sup> that

<sup>10</sup> Maud Garner: J. Phys. Chem., 30, 1401 (1926).

<sup>11</sup> Freundlich and Kroch: Z. physik. Chem., 124, 158 (1926).

<sup>12</sup> Freundlich and Loebmann: Z. physik. Chem., 139, 368 (1928).

continuous stirring during a run affects the speed of coagulation and the conditions have not yet been worked out to ensure reproducibility of results in that case.

It seemed likely that the low values of  $\beta$  for the 10 secs. and 15 secs. coagulation times were due to the time required for complete mixing of the electrolyte with the sol. This conclusion was borne out by certain experiments carried out with vigorous stirring for 5 secs. (instead of one second). It was then found that the  $\beta$  value even for the 10 sec. coagulation time was decidedly greater than that recorded in the table.

*Observed Values for the Temperature Coefficient of the Rate of Coagulation of Gold Sol.*

Employing gold sols which had reached the steady reproducible state by having been maintained at 80°C for three hours, Miss Davies (*loc. cit.*) has examined the influence of temperature upon the coagulation process itself. In Miss Davies' case the amount of electrolyte employed was only sufficient to give rise to "slow" coagulation. Under these conditions it was found that whilst the influence of temperature upon the Smoluchowski coefficient  $\beta$  was very largely accounted for by the alteration in the viscosity of the medium—as it should be on the basis of the Smoluchowski theory—some other effect entered at the same time. It is not improbable that this had to do with the fact that all the colloidal particles had not been electrically discharged. In view of this conclusion it becomes of importance to endeavour to measure the influence of temperature upon the rate of coagulation in the "rapid" region, where electrical effects have been eliminated by the choice of the concentration of the coagulating electrolyte. This type of measurement is rendered possible by the use of the improved apparatus already described, which permits of high coagulation speeds being measured with accuracy.

Two sets of measurements were carried out:— (a) 100 cc. samples of the sol, contained in the quartz flasks, were immersed in a thermostat at 80°C for three hours in order to eliminate thermo-senescence. After this period of immersion, they were coagulated at 80°C, the time allowed for coagulation being 20 secs. (b) 100 cc. samples of the sol, as in (a), were maintained at 80°C for three hours. After this period of 'ageing' the flasks were removed to the 25°C thermostat and left for two hours before coagulation for 20 secs. at 25°C.

The results are given in Table II.

TABLE II

Sol	Coagn. Time	$\beta_{80^\circ}$	$\beta_{25^\circ}$	$\beta_{80^\circ}/\beta_{25^\circ}$
XII	20 secs.	0.0500	0.0174	3.01
XII	20 "	0.0500	0.0166	2.87
XIII	20 "	0.0256	0.0087	2.94
XIII	20 "	0.0256	0.0083	3.08
XIV	20 "	0.0311	0.0103	3.02

For the sake of comparison it may be mentioned that the values obtained by Miss Davies varied between 3.283 and 1.544.

On the basis of the Smoluchowski theory it would be expected that if the effect of temperature on coagulation is due solely to the change in viscosity of the sol, the following expression should hold:—

$$\beta_2/\beta_1 = \eta_1 T_2/\eta_2 T_1$$

Where,  $\beta_2$  = value of  $\beta$  at  $T_2$

$\beta_1$  = value of  $\beta$  at  $T_1$

$\eta_2$  = viscosity of the sol at  $T_2$

$\eta_1$  = viscosity of the sol at  $T_1$

$T_1, T_2$  = absolute temperatures at which the coagulations are carried out ( $T_2 > T_1$ )

Since the viscosity of the sol does not differ appreciably from that of the medium, water, it follows that the theoretical value of  $\beta_{30^\circ\text{C}}/\beta_{25^\circ\text{C}}$  should be 2.964. It may be inferred from the results in Table II that this relation holds quantitatively for coagulation in the "rapid" region.

In the region of "slow" coagulation, a quantity  $\beta$ , is introduced by Smoluchowski into the velocity. This quantity, erroneously regarded as a constant by Smoluchowski, is the fraction of effective encounters. It is not independent of temperature and in this region, therefore, change in viscosity will not account entirely for the change in speed of coagulation of the sol. This fact probably accounts for the results of Miss Davies<sup>1</sup> and Westgren<sup>13</sup> who worked with gold sols in the region of "slow" coagulation, and Jablczynski and Knaster,<sup>14</sup> working with ferric oxide sol, all of whom found that the effect of temperature was not accounted for by the change in viscosity of the sol alone.

Freundlich and Basu,<sup>15</sup> working with copper oxide sol, and Lachs and Goldberg,<sup>16</sup> who worked with gold sols, obtained results in agreement with those obtained in the present investigation, but it is felt that the methods employed in the present work allow a more rigid control to be exercised.

The results given in the foregoing table are those which would be expected if coagulation in the "rapid" region of the sol previously rendered thermostable is a purely physical operation and no critical increment in the usual chemical sense is involved.

#### Summary

(1) It is shown that the phenomenon of thermo-senescence which had already manifested itself by its effect upon the subsequent rate of coagulation in the "slow" region, likewise manifests itself by its effect upon the subsequent rate of coagulation in the "rapid" region. This is interpreted to mean that thermo-senescence is accompanied by an alteration (namely a decrease)

<sup>13</sup> Westgren: Arkiv. Kemi. Min. Geol., 7, No. 6 (1918).

<sup>14</sup> Jablczynski and Knaster: Bull., 43, 156 (1928).

<sup>15</sup> Freundlich and Basu: Z. physik. Chem., 115, 203 (1925).

<sup>16</sup> Lachs and Goldberg: Kolloid-Z., 39, 166 (1926).

in the value of the range of attraction postulated by Smoluchowski as existing around each sol particle. This alteration in  $\rho$  may be attributed not unreasonably to an actual decrease in the dimensions of the sol units.

(2) Employing a form of apparatus in which it is possible to measure coagulation with accuracy over short time periods (20 seconds) measurements have been made of the Smoluchowski coefficient  $\beta$  at two temperatures in the region of "rapid" coagulation.

(3) From the data obtained in the region of "rapid" coagulation, it is concluded that the effect of temperature in this region (though not in the region of "slow" coagulation) is quantitatively accounted for by the change in viscosity of the system, as is demanded by the Smoluchowski theory.

The above work was carried out in the Department of Physical Chemistry of the University of Liverpool under the direction of Professor W. C. M. Lewis. The cost of the investigation was borne by a grant made to the Department by Imperial Chemical Industries Ltd. (England).

The writer wishes to acknowledge his indebtedness to the Lord Kitchener National Memorial Fund for a personal grant.

*The University,  
Liverpool,  
England.  
September 12, 1929.*

## ON THE ADSORPTION OF GASES BY SOLIDS

BY ASHUTOSH GANGULI

The intimate connection of adsorption with surface tension was shown long before by Gibbs, subsequently known as Gibbs-Thomson equation. This equation is generally derived from thermodynamical considerations, which also leads to the following extension of the gas laws<sup>1</sup> to the surface,

$$\pi\Omega = RT \quad (1)$$

Where  $\pi$  is the difference of surface-tensions of the pure solvent and solution and  $\Omega$  corresponds to the area usually covered by the adsorbed substance.  $R$  and  $T$  are well-known symbols. Later on Langmuir<sup>2</sup> has derived the following interesting relationship between the concentration of the adsorbed substance and the amount adsorbed from purely kinetic theory:

$$C = \frac{k\eta}{1-\eta\beta} \quad (2)$$

where  $C$  is the concentration,  $k = \text{constant}$  (Langmuir's constant),  $\eta = \text{amount adsorbed, being equal to } \frac{1}{\Omega}$ ,  $\beta = \text{another constant}$ . Recently Volmer<sup>3</sup> has tried to combine the thermodynamical derivation of Gibbs-Thomson formula with modified equation of state for the surface

$$\pi(\Omega - \beta) = RT \quad (3)$$

which is readily obtained from kinetic theory by introducing corrections similar to that of van der Waals. Thus he claims to have arrived at a general formula

$$C = \frac{k\eta}{1-\eta\beta} e^{\frac{\eta\beta}{1-\eta\beta}} \quad (4)$$

which, by neglecting  $\beta^2$  reduces to

$$C = \frac{k\eta}{1-2\eta\beta} \quad (5)$$

similar to that of Langmuir if  $2\beta$  is substituted for  $\beta$ .

Later on K. C. Kar<sup>4</sup> has derived Langmuir's formula by purely statistical methods and has obtained an interesting formula for the Langmuir constant

$$k = \frac{(2\pi MRT)^{\frac{1}{2}}}{hN} e^{-\alpha/RT} \quad (6)$$

where  $\pi$ ,  $R$ ,  $h$ ,  $N$  and  $T$  have their usual significance,  $M$  is the molecular weight in grams of the adsorbed substance,  $\alpha$  is the adsorption potential. Very recently Kar and Ganguli<sup>5</sup> have also arrived at the same Langmuir's

<sup>1</sup> Freundlich: "Capillary and Colloid Chemistry," 46 (1926).

<sup>2</sup> Met. Chem. Eng., 15, 469 (1916); J. Am. Chem. Soc., 38, 2221 (1916); 39, 1848 (1917).

<sup>3</sup> Z. physik. Chem., 115, 253 (1925).

<sup>4</sup> Physik Z., 26, 615 (1925).

<sup>5</sup> Physik. Z., (Communicated for publication)

formula by applying the statistical method of Gibbs. Their value of  $k$  is however more general, as

$$k = \frac{(2\pi MRT)^{\frac{3}{2}}}{\rho N} e^{-\alpha/RT} \quad (7)$$

$\rho$  being a constant, and the other symbols having the same meaning as in (6). If we consider the thickness of the adsorption layer to be unimolecular then  $\rho$  in (7) will have the minimum value  $h$ . Thus the value of  $k$  becomes identical with that of S. C. Kar.

Now, the adsorption potential  $\alpha$  may be identified with the heat of adsorption. Again, if instead of considering the thickness of the adsorption layer to be multimolecular, we take it as unimolecular,<sup>6</sup> then the adsorption potential becomes identical with the maximum value of the potential of Polanyi.<sup>7</sup> Incidentally it may be remarked that Lowry and Olmstead<sup>8</sup> have also suggested that the heat of adsorption =  $\sum_i E \Delta x$  where  $x$  = mass adsorbed.  $E$  = adsorption potential (as defined by Polanyi)  $\Delta x$  = mass adsorbed; thus for maximum adsorption (which is expected at the equilibrium stage) the heat of adsorption corresponds to the maximum adsorption potential. The accompanying table taken from the previous paper of Kar and Ganguli<sup>6</sup> point out clearly that the heat of adsorption in several cases approximates to Polanyi's maximum potential as determined by Berenyi<sup>9</sup> from the data of standard authors.

TABLE I

Gas	Heat of Adsorption in Cal.	Heat of Sublimation in Cal.	Maximum Adsorption Potential in Cal.
Argon	3,636	4,180	4,100 (Homfray)
Nitrogen	3,686		4,320 (H), 4450 (Titoff)
Carbon monoxide	3,416	3,715	4,840 (H)
Carbon dioxide	7,300	6,100	6,100 (H), 5,700 (Richardson)
Ammonia	7,200	7,120	7,180 (H), 8,600 (Patrick)
Methane	—	—	5,320 (H)
Ethylene	—	—	7,100 (H)

It will also be noted that the above table shows a remarkable agreement between the heat of adsorption and heat of sublimation. This agreement if it is true for all cases of adsorption, is certainly of fundamental importance, for it throws a considerable light on the mechanism of adsorption. It has been remarked by several authors that the adsorbed substance is present in a very condensed form on the surface.<sup>10</sup> According to Langmuir<sup>2</sup> the adsorbed

<sup>6</sup> Langmuir: loc. cit. 2, Harkins and collaborators: J. Am. Chem. Soc., 39, 354, 541 (1917) et seq.; also Adam: Proc. Roy. Soc., 99A, 344, 350 et seq.; also Freundlich: "Capillary and Colloid Chemistry," 314 (1926).

<sup>7</sup> Ber. deutsch. physik. Ges., 16, 1012 (1914); 18, 55 (1916), Z. Elektrochemie, 26, 370 (1920).

<sup>8</sup> J. Phys. Chem., 31, 1601 (1927).

<sup>9</sup> Z. physik. Chem., 94, 625 (1920).

<sup>10</sup> Eucken: Ber. deutsch. physik. Ges., 16, 345 (1914); Freundlich: "Capillary and Colloid Chemistry," 325 (1926); Patrick: J. Am. Chem. Soc., 42, 946 (1920).

molecules are held on the surface by the residual valencies of the adsorbent. Since the adsorption potential is equal to the heat of sublimation, it can be very well supposed that adsorption is essentially a process of condensation on the surface, the adsorbed substance being present as a layer of solid at the interface of the adsorbent forming adsorption compounds, somewhat similar to the solid solution but much more complex in nature.

That we are justified in regarding adsorption layer as unimolecular in most cases, and that the heat of adsorption is equal to Polanyi's maximum potential on the one hand and the heat of sublimation on the other is also confirmed by the agreement of the theoretical value of  $k$  with that calculated from the experimental data of various standard authors as given in Table II.

TABLE II

Gas	Temp. °C	Value of Q used in Cal.	k Exp.	k Calc.	Experimenter
Argon	-78°	4,100	$3.326 \times 10^3$	$6.929 \times 10^3$	Homfray
Carbon monoxide	0°	4,840	$3.682 \times 10^4$	$6.425 \times 10^4$	"
	20°C	"	$7.868 \times 10^4$	$15.67 \times 10^4$	"
	-33.6°	"	$1.689 \times 10^5$	$1.761 \times 10^4$	"
	"	3,715	"	$1.857 \times 10^5$	"
Carbon dioxide	0°C	6,100	$9.208 \times 10^3$	$7.745 \times 10^3$	"
	30°	6,100	$1.869 \times 10^4$	$2.484 \times 10^4$	Richardson
Nitrogen	0°	4,320	$2.885 \times 10^5$	$2.048 \times 10^5$	Homfray
Ammonia	0°	7,180	$40.5 \times 10^2$	$6.645 \times 10^2$	Titoff
Methane	0°	5,320	$1.463 \times 10^4$	$2.384 \times 10^4$	Homfray
Ethylene	20°	7,100	$5.193 \times 10^3$	$2.002 \times 10^3$	"

This agreement (Table II) gives conclusive evidence in favour of Langmuir's theory. Volmer's methods are defective in the sense that he has combined thermodynamics with kinetic theory. Had he adopted purely thermodynamic methods and used equation (1) instead of (3) he would not have arrived at his so-called general equation (4). Again had he followed the kinetic method throughout, he would have obtained an equation

$$vdp = (\Omega - \beta)d\pi$$

instead of his thermodynamical relation<sup>2</sup>

$$vdp = \Omega d\pi$$

and thus he would have obtained Langmuir's equation.

Lastly we may note that the equation of state for adsorbed substance at the surface should be  $\pi(\Omega - \beta) = RT$  and not  $\pi\Omega = RT$  as has been conclusively shown by the beautiful work of Adams.<sup>11</sup> The value of  $\beta$  has been

<sup>11</sup> Loc. cit. 6; also Frumkin: Z. physik Chem., 116, 490 (1926).

suggested by him to be equal to double the area of a mole of the adsorbent, similar to the volume correction of van der Waals. If this correction is introduced, a modified Gibbs-Thomson equation

$$\alpha = \frac{r}{(r/\eta - \beta)} = - \frac{c}{RT} \frac{d\gamma}{dc} \quad (8)$$

is obtained,  $\gamma$  being the surface tension and  $c$  the concentration. It may be remarked that for very dilute solution the correction introduced can be neglected for in that case we may regard equation (1) to be true. The experimental works of Donnan and Barker<sup>12</sup> point that the value of  $\alpha$  (observed) is somewhat greater than that of  $\alpha$  (calculated). Again W. C. Mc. Lewis<sup>13</sup> and others have been able only to test the order for  $\alpha$ .

Hence the experimental evidence does not go against the correction suggested above.

I have the pleasure of thanking Dr. K. C. Kar for his interest in this work.

*Physical Laboratory,  
Presidency College,  
Calcutta.*

<sup>12</sup> Proc. Roy. Soc., 85A, 557 (1911).

<sup>13</sup> Z. physik. Chem., 73, 129 (1910).



## THE EFFECT OF ETHANE AND NITROGEN ON THE RATE OF THERMAL DECOMPOSITION OF AZOMETHANE AT LOW PRESSURES

BY HERMAN C. RAMSPERGER\*

The rate of decomposition of azomethane has previously been shown to be first order at high pressures but the rate decreases at low pressures.<sup>1</sup> It was found, however, that the first order rate constant did not change during the progress of any given experiment even at low pressures. This indicated that the products of the reaction exerted about the same influence in maintaining the rate as their equivalent of azomethane would. These products are ethane and nitrogen and it is the purpose of this communication to present some roughly quantitative data on the effect of adding these gases to azomethane at a partial pressure of about 1 mm.

### Experimental Procedure

Ethane was prepared by hydrolyzing the Grignard reagent, freezing out the ether with carbon-dioxide snow and ether, then freezing out the ethane with liquid air and finally fractionally distilling the ethane. Nitrogen was prepared by very slowly heating recrystallized sodium azide in vacuum and passing the evolved gas thru a liquid air trap.<sup>2</sup> The thermal decomposition was carried out in the same Pyrex reaction vessel previously used<sup>1</sup> but the gases were handled and pressures determined with the special greaseless stopcock and McLeod gauge described recently.<sup>3</sup> The procedure in using it for this particular research was explained in the article referred to and needs no further comment. Rate constants were calculated as described in a previous article.<sup>4</sup>

### Experimental Data

Three experiments were made with azomethane alone at an initial pressure of 0.100 cm during the course of the experiments with inert gases. The average rate constant was  $0.52 \times 10^{-3}$  which is very nearly the same as that found from the curve of Fig. 1 of reference 1, namely  $0.53 \times 10^{-3}$ . Table I gives a summary of the results.

The data in the last column are calculated in the following manner: We may determine the relation between rate constant and initial pressure of azomethane from Fig. 1 of reference 1. For our present purpose it is sufficiently accurate to take the linear relation  $\Delta \log k = .35 \Delta \log P$ . We then accept as the rate constant for pure azomethane at a pressure of 0.100 cm. the value  $0.52 \times 10^{-3}$ . We can then calculate the initial pressure of azo-

\* National Research Fellow in Chemistry.

TABLE I

Partial pressure azomethane cm.	Inert gas	Partial Pressure inert gas cm.	Total pressure cm.	Av. rate constant $k \times 10^3$ sec <sup>-1</sup>	Equivalent azomethane pressure cm.
0.1000	none	—	0.1000	0.52	0.100
0.1019	ethane	0.0435	0.1454	0.608	0.155
0.1023	ethane	0.0690	0.1715	0.583	0.140
0.1003	ethane	0.1993	0.2996	0.752	0.290
0.1031	ethane	0.2277	0.3308	0.697	0.230
0.0974	nitrogen	0.2142	0.3116	0.52	0.100
0.0998	nitrogen	0.8136	0.9134	0.64	0.180
0.1008	nitrogen	1.3686	1.4694	0.81	0.355

methane without added gas that would have given the rate constants in the second column from the right. In case the added gas is ethane these figures show that this equivalent azomethane pressure approaches on the average very close to the total pressure, that is, the added ethane is nearly equivalent to azomethane itself in maintaining the rate. Nitrogen, on the other hand, is far from being equivalent to azomethane. A more exact evaluation of the contribution of these gases to the reaction rate cannot be given because of the limited increase in rate and the appreciable experimental error over the range of pressures studied. They do show, however, that the combined effects of the ethane and nitrogen produced during the thermal decomposition would be sufficient to maintain the reaction rate at its initial value. They show furthermore that most of the effect is due to the ethane.

#### Discussion

These results require some comment in connection with certain reaction rate theories which have been found to be in agreement with the experimental data on azomethane and other unimolecular reactions.<sup>5</sup> According to these theories the rate is not maintained at low pressures since collisions cannot supply activated molecules sufficiently fast for reaction and also maintain the Maxwell-Boltzmann fraction of activated molecules. If now an inert gas be added it will increase the rate of activation insofar as it is able to transfer internal energy on collision with azomethane molecules. In order to calculate the rate of activation it was necessary to make the assumption<sup>6</sup> that deactivation (or at least a certain sufficient loss of energy) occurs at every collision of an activated molecule. This assumption could be justified in the case of an azomethane molecule if statistical equilibrium occurs between the combined internal degrees of freedom of two colliding azomethane molecules. Any inert gas which collides as frequently as does azomethane and deactivates an activated azomethane molecule at each collision will therefore be as effective as azomethane itself in maintaining the rate. Apparently this is very nearly the case with ethane. Nitrogen, however, could only produce the smaller effect through fewer collisions with azomethane than azomethane

itself or through failure to deactivate many of the activated azomethane molecules with which it collides. Kinetic theory data indicates that the number of collisions will not be changed appreciably so we must conclude that the nitrogen molecule exchanges but very little energy with an activated azomethane molecule. This is probably due to the limited internal energy of the nitrogen molecule and to the fact that the frequencies of the molecule may be sufficiently different from those of azomethane that statistical equilibrium is not established between the combined internal degrees of freedom of the two molecules at collision.

*Stanford University, California,  
July 14, 1929.*

#### Bibliography

- <sup>1</sup> Ramsperger: *J. Am. Chem. Soc.*, **49**, 1495 (1927).
- <sup>2</sup> Later in preparing nitrogen by the same method for another purpose an explosion occurred. The method should never be used to prepare larger quantities of nitrogen.
- <sup>3</sup> Ramsperger: *J. Am. Chem. Soc.*, **51**, 2132 (1929).
- <sup>4</sup> Ramsperger: *J. Am. Chem. Soc.*, **51**, 2134 (1929).
- <sup>5</sup> Rice and Ramsperger: *J. Am. Chem. Soc.*, **49**, 1617 (1929).
- <sup>6</sup> See Rice and Ramsperger: *J. Am. Chem. Soc.*, **49**, 1626 (1929).

## NEW BOOKS

**Analytical Processes, a Physical-Chemical Interpretation.** By *T. B. Smith*. 22 × 14 cm; pp. viii + 373. London: Edward Arnold and Co. Price: 12 shillings, 6 pence. The days when quantitative analysis was treated purely empirically are rapidly passing, more and more interest being taken in the underlying theory upon which all analytical processes rest.

It is most desirable that all instruction in analytical methods should include adequate theoretical explanations of the experimental procedure. The book under review should materially assist in this. It should be very useful to teachers for it is interestingly and thoughtfully written and covers the whole range of the subject very thoroughly. Most students, except the very advanced ones, will probably find it rather beyond them. In the reviewer's opinion it is better, for the student, to incorporate theory and practice in one volume and not to deal almost exclusively with theory as is done in the present book. The book is well produced and is very free from misprints and other errors. Only one of the latter has been noticed. The name "Silver ammonium ion" which is used frequently by the author for the complex ion  $[\text{Ag}(\text{NH}_3)_2]^+$  is very undesirable and misleading. It is true that the cations of the metal ammines are formed by a similar process to that by which the ammonium ion is formed, but they cannot be regarded as being substituted ammonium ions as the above name would imply—nor do these ammines contain ordinary ammonium ions which some readers might infer from such a name.

The book is divided into two parts:—Part I. The theoretical foundations of some typical processes and Part II. A critical examination of some theories employed—but this subdivision does not seem really necessary and has led to a good deal of repetition.

A number of useful literature references are given throughout the book but it is a curious fact that nowhere, not even in the preface, is any reference or any acknowledgment made by the author to other books on similar lines. It may be deduced from the general lines followed that he has made considerable use of such books and he should have referred to them.

*H. Bassett*

**Aluminiumoxyd als Katalysator in der organischen Chemie.** By *W. N. Ipatiew*. Translated by *Carl Freitag*. 21 × 15 cm; pp. vi + 91. Leipzig: Akademische Verlagsgesellschaft, 1929. Price: 6.60 marks. This is an interesting little monograph to show that aluminum oxide is very nearly the universal catalyst. Everybody knows that it converts alcohol nearly quantitatively into ethylene and water; but it is not so generally known that it will convert dimethyl trimethylene into trimethyl ethylene, and this latter into isopropyl ethylene; cyclohexane into methyl cyclopentane; unsymmetrical dimethyl allylene or isopropyl acetylene into isoprene. Ethylene glycol is converted into acetaldehyde, presumably after passing through ethylene oxide as an intermediate stage.

Alumina causes the condensation of ethylene into polymethylenes and also into unsaturated hydrocarbons, such as amylene and hexylene. Acetylene and ammonia give a mixture of pyrrol, picoline, and collidine; while acetylene and hydrogen sulphide give thiophene. Acetaldehyde and ammonia give the pyridine bases. Ethylene and acetone apparently give hydrocarbons of the terpene series, while methyl alcohol and acetone give hexamethyl benzene. This same product is obtained from phenol and methyl alcohol at atmospheric pressure, whereas, at high pressures, anisol, o-cresol, and xanthene are obtained. Aniline and alcohol benzyl an eighty-one percent yield of benzyl aniline.

Alumina splits off hydrogen chloride completely from isobutyl chloride at 350°. In diffused light hydrous alumina causes chlorine to form hexachlorobenzene from benzene. With hydrogen under pressure and in presence of alumina, cyclohexanol goes over almost quantitatively at 430° into cyclohexane.

The weak part of the pamphlet is the theoretical discussion which should be skipped by the sympathetic reader.

*Wilder D. Bancroft.*

## ON THE EXISTENCE AND BEHAVIOR OF COMPLEX POLYIODIDES

BY GRINNELL JONES

Gay-Lussac<sup>1</sup> during his early fundamental researches on the properties of iodine and its compounds, observed that "All of the hydroiodates [iodides in modern terminology] have the property of dissolving iodine abundantly, thereby becoming strongly colored reddish-brown. But they only retain the iodine with very feeble force; for they give it up on boiling or on evaporation to dryness in air; moreover, the iodine does not change the neutrality of the hydroiodates (iodides) and the reddish-brown coloration of the liquid, similar to that of other solutions of iodine, is a new proof of the feebleness of the combination." He suggests the name "hydroiodate iodure" for the combination. He is here contrasting the feebleness of the combination of the iodine in the colored polyiodides, with the firmer combination in the colorless iodides.

Baudrimont<sup>2</sup> found that when a solution of potassium iodide containing iodine is shaken repeatedly with carbon bisulfide the dissolved iodine can be completely extracted, leaving the potassium iodide in the aqueous layer. He regarded this as proof that no compound is formed between iodine and potassium iodide in solution.

Dossios and Weith<sup>3</sup> determined the solubility of iodine in strong solutions of potassium iodide and found that with increasing concentration of the potassium iodide the solubility of the iodine increases more than proportionally with the concentration of the potassium iodide. Or in other words, a concentrated solution of potassium iodide saturated with iodine will precipitate iodine on dilution with water. They also observed that by blowing air through a solution of potassium iodide containing dissolved iodine, the iodine can be completely removed. They regarded this as proof that no compound is formed.

But this interpretation was soon challenged by Jörgensen,<sup>4</sup> who points out that the facts given by Baudrimont and by Dossios and Weith do not disprove the existence of compounds because if there is even a slight dissociation of the compound into free iodine and iodide the continual removal of the free iodine by any means will result in a shift of the equilibrium and eventually complete dissociation of the compound. However, Jörgensen was unwilling to assert that a compound is formed but concluded that the matter was still unsettled and would be very difficult to settle. And indeed, progress had to wait for twenty years until van't Hoff and Raoult had interpreted the freezing

<sup>1</sup> J. L. Gay-Lussac: *Ann. Chimie*, 91, 72 (1814). (Quotation translated by the author.)

<sup>2</sup> E. Baudrimont: *Compt. rend.*, 51, 827 (1860).

<sup>3</sup> L. Dossios and W. Weith: *Z. Chem.*, 5, 380 (1869).

<sup>4</sup> S. M. Jörgensen: *J. prakt. Chem.*, 110, 347 (1870).

points of solutions and thus furnished a new method of attack. It was then found by LeBlanc and Noyes<sup>1</sup> that when iodine dissolves in a solution of potassium iodide there is no appreciable change in freezing point and a considerable decrease in electrical conductivity. They found that a 1 N KI solution had a freezing point of  $-3.375^{\circ}\text{C}$ ., whereas the same solution with  $1/5$  mol  $\text{I}_2$  added had a freezing point of  $-3.335^{\circ}\text{C}$ ., and with  $2/5$  mols  $\text{I}_2$  added had a freezing point of  $-3.325^{\circ}\text{C}$ .. Instead of finding a greater depression of the freezing point due to the added iodine, they find an elevation of the freezing point of  $0.050^{\circ}$  which they regard as insignificant. They point out that if all of the added iodine in the later case had gone into solution as free iodine, it would have produced an additional depression of the freezing point of  $0.76^{\circ}\text{C}$ .. Since the addition of iodine caused no additional depression, they conclude that it must have combined with the potassium iodide in such a way that the number of dissolved particles is essentially unchanged and that the heavy complex ion has a smaller mobility than the iodide ion, and that there is some free  $\text{I}_2$  in the solution. These experiments show that each complex ion contains one iodide ion only and, therefore, carries only one negative charge but do not permit a conclusion as to the exact formula of the complex.

The next important step was soon taken by Jakowkin,<sup>2</sup> who proved that the complex ion has the formula  $\text{I}_3^-$  by means of quantitative experiments on the distribution ratio of iodine between carbon bisulfide (and other solvents) and solutions of potassium iodide (and other iodides). The free iodine ( $\text{I}_2$ ) in the solution of potassium iodide was computed from the analyses of the carbon bisulfide layer by the use of the distribution ratio obtained with pure water. The free iodine was then subtracted from the total titratable iodine and the difference assumed to be tri-iodide. Then the remaining iodide was computed by subtracting the tri-iodide from the original iodide. Jakowkin found that a good constant can be obtained for the equilibrium constant

defined by the equation  $k = \frac{\text{KI} \times \text{I}_2}{\text{KI}_3}$  except in solutions which are concen-

trated in potassium iodide or saturated or nearly saturated with iodine or both, which gave lower values for the constant. The following table summarizes his results, the numbers in parentheses in the third column being the result obtained with solutions saturated or nearly saturated with iodine

TABLE I

Summary of Jakowkin's Values of Tri-iodide Equilibrium Constants at  $25^{\circ}\text{C}$

Normality of KI solution	$k = \frac{\text{I}_2 \times \text{KI}}{\text{KI}_3}$	Normality of KI solution	$k = \frac{\text{I}_2 \times \text{KI}}{\text{KI}_3}$
1	0.001365 (0.000773)	1/8	0.001380 (0.001314)
1/2	0.001407 (0.001084)	1/16	0.001395 (0.001341)
1/4	0.001399 (0.001255)	1/32	0.001392 (0.001385)

<sup>1</sup> M. LeBlanc and A. A. Noyes: *Z. physik. Chem.*, 6, 401 (1890).

<sup>2</sup> A. A. Jakowkin: *Z. physik. Chem.*, 13, 539 (1894); 18, 585 (1895); 20, 19 (1896).

and those in the second column being an average of the values obtained with solutions which are less concentrated in iodine and which show no systematic trend in spite of considerable variations in iodine

These experiments prove that the much greater solubility of iodine in potassium iodide solutions as compared with its solubility in pure water is due to the reaction  $KI + I_2 \rightleftharpoons KI_3$ . Jakowkin also found that many other iodides gave the same equilibrium constant which indicated that the cation takes no part in the reaction so that the reaction is preferably written  $I^- + I_2 \rightleftharpoons I_3^-$ . The lowering of the constant in the more concentrated solutions, especially in the strong KI solutions, indicates that higher complexes are formed in small amounts in the concentrated solutions and that two or more monovalent iodide ions unite with two or more iodine molecules ( $I_2$ ) to form a polyvalent complex ion.

The solubility of iodine in pure water at 25°C. was found by Noyes and Seidensticker<sup>1</sup> to be 0.00134 moles per liter. They also determined the solubility in potassium iodide solutions up to 0.1 N KI. They interpret their data on the assumption that the concentration of free iodine ( $I_2$ ) in equilibrium with solid iodine is the same in any potassium iodide solution as in pure water and that the dissolved iodine in excess of the amount which dissolves in water is present as  $KI_3$  (or  $I_3^-$ ). They found that these solutions which are saturated with iodine contain approximately equal amounts of KI and  $KI_3$  and confirm Jakowkin's explanation of the mechanism of the reaction.

Dawson,<sup>2</sup> using methods similar to those of Jakowkin, found the following values for the equilibrium constant: at 13.5°C., 0.001015; at 15°C., 0.001035; at 18°C., 0.001153; and at 25°C., 0.001356.

Osaka<sup>3</sup> has made freezing point measurements of a similar character to those of Le Blanc and Noyes but on a more extensive scale with similar results. In his experiments the concentration of the potassium iodide solution was varied from 0.155 to 1.000 normal and the dissolved iodine from 0.01 to 0.403 moles  $I_2$  per liter. He also carried out similar experiments with hydriodic acid instead of potassium iodide. In all cases he found a rise in freezing point on adding the iodine instead of a greater depression of the freezing point as would be given if the dissolved iodine did not combine with the iodide. He interprets his data as proving the formation of a compound  $KI_3$  (or  $HI_3$ ). The slight rise in freezing point which LeBlanc and Noyes regarded as insignificant in their experiments was found consistently by Osaka in all of his measurements and is regarded by him as greater than his probable experimental error. His interpretation of this rise in freezing point is that the degree of electrolytic dissociation of  $KI_3$  into the ions  $K^+$  and  $I_3^-$  is slightly less than the degree of dissociation of KI. In the case of his solutions of hydriodic acid the effect is greater and is explained in the same way. An interpretation in the more modern fashion of these experiments would be that

<sup>1</sup> A. A. Noyes and J. Seidensticker: *Z. physik. Chem.*, 27, 357 (1898).

<sup>2</sup> H. M. Dawson: *J. Chem. Soc.*, 79, 238 (1901); 81, 1086 (1902); 93, 1308 (1908).

<sup>3</sup> Y. Osaka: *Z. physik. Chem.*, 38, 743 (1901).

the activity coefficient of  $KI_3$  is less than that of  $KI$  at the same concentration, which may not advance our knowledge very much because it amounts to another form of words for saying that the effect of  $KI_3$  on the freezing point is not as great as that of an equivalent concentration of  $KI$ . Or the slight rise in freezing point on adding the iodine may be due to the formation of a more complex polyiodide containing more than one iodide ion.

The next new line of evidence on the problem is furnished by the experiments of Burgess and Chapman,<sup>1</sup> who proved that when a direct electric current is passed through a solution of potassium iodide containing dissolved iodine, the dissolved iodine migrates to the anode. This proves very definitely that the dissolved iodine is part of a negative ion, and is not merely dissolved as  $I_2$  or any other uncharged molecule. These experiments, therefore, confirm the conclusion that a complex anion is formed which was drawn by Jakowkin from his distribution experiments and by Le Blanc and Noyes from their freezing point experiments. Burgess and Chapman also conclude from their experiments that if the complex is taken as  $I_3^-$  on the basis of Jakowkin's results, then the mobility of the tri-iodide ion is 0.566 of that of the iodide ion.

It is now in order to discuss three important papers by Charles L. Parsons<sup>2</sup> and collaborators. The experimental data in these papers includes;

(a) confirmation of the observations of LeBlanc and Noyes, and of Osaka that when iodine is added to a solution of potassium iodide the freezing point is raised a few hundredths of a degree instead of being further depressed by the added solute;

(b) Phase Rule studies of the system potassium iodide-iodine-water, at 25°C. including measurements of the solubility of iodine in very concentrated solutions up to saturation with both iodine and potassium iodide, which occurs when the solution contains 5.17 moles of  $KI$  and also 17.80 gram atoms of iodine per liter. They confirm the observation of Dossios and Weith that the solubility increases more than proportionally to the concentration of potassium iodide in the strong solutions so that concentrated potassium iodide solutions saturated with iodine will precipitate iodine when diluted with water. They interpret their experiments as proof that solid  $KI_3$  can not exist at 25°C;

(c) similar Phase Rule studies with ethyl alcohol added as a fourth component;

(d) observations that when iodine is added to a solution of potassium iodide the electrical conductance decreases about 10 to 12 percent., confirming earlier similar observations of LeBlanc and Noyes.

(e) diffusion experiments to be discussed more in detail below.

Parsons' interpretation of these data is however very different from that of earlier investigators. Parsons says, "It is the purpose of this paper to study in some detail ternary mixtures in which the solute is itself insoluble

<sup>1</sup> C. H. Burgess and D. L. Chapman: *J. Chem. Soc.*, 85, 1305 (1904).

<sup>2</sup> C. L. Parsons: *J. Phys. Chem.*, 11, 659 (1907); C. L. Parsons and H. P. Corliss: *J. Am. Chem. Soc.*, 32, 1367 (1910); C. L. Parsons and C. F. Whittemore: 33, 1933 (1911).



or but slightly soluble in that one of the mixed solvents which first separates as a solid phase on cooling." . . . "Two facts should be stated: First, there has been for some time in the literature of chemistry a clearly defined principle, apparently unnoticed by most writers, which will explain many of the seeming discrepancies of the dissociation theory without the assumption of complex molecules. Second, a dissolved solid itself frequently acts as a solvent or, if one prefers so to view it, alters the nature of the liquid in which it dissolves, the resultant solution becoming a true solvent with entirely different freezing-point which is *raised* in the particular case under consideration. It may be, however, variously affected according to other solubility relations which the three components of the ternary mixture bear to each other. Unfortunately the effect must, for the present at least, remain qualitative only."

The "clearly defined principle" referred to above is due to Miller<sup>1</sup> "who, starting with a theorem of Gibbs, shows thermodynamically that in all such solutions as those so far cited the freezing point must rise." Parsons then gives a further exposition of Miller's views as to the thermodynamic properties of ternary mixtures in general terms and with other illustrative examples.

Miller's views for the special cases of the type under discussion may be briefly stated as follows. If we have a ternary mixture of A, B, and C then  $\frac{d\mu_c}{dm_a} = \frac{d\mu_a}{dm_c}$ , where  $\mu_a$  and  $\mu_c$  are the potentials of these substances in the mixture in the sense that the word is used by Gibbs and  $m_a$ ,  $m_c$  are the amounts of these components of the mixture. Miller argues that if the addition of A to the solution saturated with C causes a precipitation of C, then for unsaturated solutions  $\frac{d\mu_c}{dm_a}$  must be positive and, therefore,  $\frac{d\mu_a}{dm_c}$  must also be positive and, therefore, the addition of more C to an unsaturated solution will increase the potential of A and hence raise the temperature at which the solution will be in equilibrium with solid A.

Miller does not discuss the case of iodine, potassium iodide, and water, but Parsons points out in effect that if we read water for A, potassium iodide for B, and iodine for C, the equation and conclusions of Miller are applicable. Since it is well known that the addition of water causes the precipitation of iodine from its saturated solutions in aqueous potassium iodide, therefore the addition of iodine to an aqueous solution of potassium iodide should favor the separation of solid water or raise the freezing point.

However, pure thermodynamics does not deal with the mechanism of processes but only with necessary relationships between properties, regardless of the mechanism. If we are interested in the mechanism of processes, we must employ molecular or kinetic reasoning, which although less rigid than thermodynamic reasoning, may give a deeper insight. Parsons' thermodynamic proof of the necessary correlation of the precipitation of iodine when water is added to a potassium iodide solution saturated with iodine, and the rise in freezing point when iodine is added to a solution of potassium

<sup>1</sup> W. Lash Miller: J. Phys. Chem., 1, 633 (1897).

iodide, does not make it any less desirable to understand the mechanism of the process but does clarify the situation by making it evident that the true mechanism must account for both of these phenomena.

If the only chemical reaction which occurred when iodine is added to a potassium iodide solution were the reaction  $I^- + I_2 = I_3^-$ , the solubility of iodine could not attain the high values found by Parsons in strong potassium iodide solutions, nor would the dilution of a solution saturated with iodine cause the precipitation of iodine, nor would the addition of iodine to an unsaturated solution cause any rise in freezing point. Parsons must therefore be given credit for pointing out that the hypothesis of the formation of triiodides is by itself insufficient to account for all of the known facts about these solutions. For the sake of clarity and fairness Parsons' own interpretation will be quoted in his own words.

Parsons says: "Although the resemblance of a mixture of water and alcohol (or acetic acid) to a mixture of water and potassium iodide is obvious, it is certainly true that the thought of the average writer is that iodine will dissolve in the first mixture simply because it is soluble in alcohol, but the idea that it can dissolve in the second simply because it is soluble in potassium iodide seems never to have occurred to the many investigators of this interesting phenomena. It is certainly true that there are striking analogies in the two instances and the solubility of the iodine increases respectively with the concentration of the alcohol or the potassium iodide. It will be held by some, and perhaps correctly, that the iodine is not soluble in one component of the binary mixture but in the liquid phase considered as a single liquid. Since the difference is simply one of the melting-point of one of the components, there is no difference whatever between a dissolved solid and a dissolved liquid and we have just as good a right to consider the iodine as soluble in the potassium iodide, itself rendered liquid by its solution in water, as we have to consider it soluble in aqueous alcohol, and *per se*, there is no more necessity to assume the formation of complex molecules in the first case than in the second to explain a rise in the freezing-point. In both cases the results follow from Miller's deduction, since the saturated solutions if diluted with water precipitate iodine. The value of this point of view becomes more apparent if we consider the solubility of iodine in aqueous acetic acid. Ordinarily this is considered a case of mixed liquids, but if we happen to be working at a temperature below 16.6° we are in reality dealing with a dissolved solid. Iodine raises the freezing point of such a liquid as does camphor or any other solid which is soluble in acetic acid and insoluble or but slightly soluble in water, always providing of course we are working with such concentration of acetic acid that it is water which first crystallizes on cooling."

It seems apparent to the reviewer that this interpretation of Parsons' fails to account for the phenomena which he especially emphasizes. If the iodine dissolves as such ( $I_2$ ) in a solution of potassium iodide it would be expected that the freezing point would be further depressed thereby but no such

additional depression is observed. LeBlanc and Noyes inferred from this fact that the dissolved iodine adds on to the iodide ion present so that the total number of dissolved ions remains unchanged. They actually observed a slight rise in freezing point but it was so slight that they regarded it as within their experimental error and made no attempt to interpret this rise. Osaka and Parsons have shown that this slight rise in freezing point is real and therefore some process must occur which causes a net decrease in the number of dissolved particles. Osaka accounts for the apparent decrease in the number of dissolved particles in accordance with the theoretical views current at the time by the hypothesis that the degree of dissociation of  $KI_3$  is less than that of  $KI$ . This interpretation has since been discredited by Bray and MacKay.<sup>1</sup> Parsons' suggestion that the iodine dissolves as such not only fails to account for the rise in freezing point but also fails to account for other known facts. Parsons has himself observed that the addition of iodine reduces the electrical conductance of a potassium iodide solution but makes no attempt to harmonize his hypothesis with this fact. Nor does he offer any explanation of the fact that the dissolved iodine moves with an electric current toward the anode as observed by Burgess and Chapman. And indeed these facts must be embarrassing to anyone who denies that the dissolved iodine forms a part of a complex anion.

Parsons and Corliss have made some experiments on diffusion of solutions containing potassium iodide and free iodide which were undertaken to give evidence as to the existence or non-existence of tri-iodides in these solutions. They made an agar-agar beaker using 0.1 N  $KI$  as solvent and studied the diffusion through this membrane. They say:

"According to Jakowkin's researches and the theory of those who believe in the presence of polyiodides, a solution of potassium iodide saturated with iodine must have one-half of the potassium iodide converted into tri-iodide and contain also a small, almost negligible amount of iodine dissolved as such in the water present.

"In the first experiment tried the outer solution was 0.1 normal potassium iodide and the inner solution was 0.16 molar potassium iodide saturated with iodine.

"According to Jakowkin the following conditions should exist and the potassium iodide should, of course, diffuse from higher to lower concentration or from left to right.

Outer Solution	Inner Solution
0.1 molar $KI$	0.08 molar $KI$
	0.08 molar $KI_3$
	0.0013 molar $I_2$

"If there is no complex present, the following condition should exist and potassium iodide should diffuse from right to left.

Outer Solution	Inner Solution
0.1 molar $KI$	0.16 molar $KI$
	0.0813 molar $I_2$

<sup>1</sup> W. C. Bray and G. M. J. MacKay: *J. Am. Chem. Soc.*, 32, 914 (1910).

"At stated periods the outer liquid was removed for analysis and replaced by a fresh portion of 200 cc. each. The first portion was taken off just as the iodine diffused to the outer wall. This took almost exactly two hours and was easily judged by the eye. It will be seen at once that the potassium iodide passed outward and that a notable portion had passed through ahead of any iodine as was to be expected from its smaller molecular weight."

They then give data showing that both potassium iodide and free iodine diffused outward and that the diffusion of the potassium iodide was more rapid.

Their own interpretation of this and of another analogous experiment is as follows:

"We believe that the above results strongly indicate that no polyiodide exists to any notable extent in these solutions and that we have here simply a case of 'solution in a dissolved solid'<sup>1</sup> a solid which above 82° has been shown by Abegg and Hamburger<sup>2</sup> to be itself a remarkable solvent for iodine."

Parsons, in his interpretation, ignores the ionization of these salts and the influence of interionic attraction on the diffusion. It seems to me that another interpretation of this experiment, making due allowance for these influences, is to be preferred. The salts are of course ionized substantially completely so that the conditions may be better described as follows, assuming tri-iodides to be formed:

Outer Solution	Inner Solution
0.1 mole K <sup>+</sup>	0.16 K <sup>+</sup>
0.1 mole I <sup>-</sup>	0.08 I <sup>-</sup>
	0.08 I <sub>3</sub> <sup>-</sup>
	0.0013 I <sub>2</sub>

The osmotic forces due to the differences in concentration would thus tend to cause a diffusion of the iodide ion from left to right and to cause a diffusion of potassium ion and tri-iodide ion from right to left.

Making due allowance for the relative magnitude of the osmotic forces and of the mobilities of the ions (K<sup>+</sup> = 74.8, I<sup>-</sup> = 76.5, I<sub>3</sub><sup>-</sup> = 41.0 at 25°) it is evident that the potassium ion will tend to diffuse most rapidly and will tend to get ahead of the tri-iodide which moves in the same direction. The result will be the establishment of a difference in electric potential between the two solutions with the left-hand solution positive compared to the right-hand solution. This difference of potential across the boundary between the

<sup>1</sup>"To explain what is meant by solution in a dissolved solid it may be pointed out that so far as analogy goes the only difference between dissolving potassium iodide in water and water in alcohol is that one is a solid and the other a liquid at the temperature at which most of our ordinary ideas are conceived. Sugar is not soluble in alcohol until water is added, but it is doubtful if any one would claim that the solubility of sugar in aqueous alcohol is due to the formation of sugar hydrates. It is simply because sugar is soluble in water and if one worked at -1° it would be a solid we were adding which, after dissolving, in its turn dissolved the sugar. In like manner working at 15° solid acetic acid dissolving in water acts as a solvent for camphor and the latter gives analogous conditions as to rise in freezing point and decrease in conductivity to those that exist when iodine, itself practically insoluble in water, is brought easily into solution when dissolved potassium iodide is present.

<sup>2</sup>Z. anorg. Chem., 50, 403 (1906)." (Footnotes quoted from Parsons and Corliss.)

two solutions will slow down the positive potassium ion and speed up the tri-iodide ion. But the tri-iodide ion being sluggish, will lag behind and the more mobile iodide ion (mobility 76.5 at 25°) will tend to accompany the potassium ion in spite of the comparatively slight difference in concentration opposing diffusion in this direction. The electric forces will ensure that the diffusing positive potassium ion will be accompanied by iodide and tri-iodide ions and that the sum of the migrating iodide and tri-iodide will be equivalent to the diffusing potassium. The diffusion outward from the more concentrated to the more dilute solution is thus to be expected in accordance with either point of view as to the existence or non-existence of the tri-iodide ions in solutions.

Laurie<sup>1</sup> has made measurements of the electromotive force of iodine-iodide concentration cells. He finds that his data are quantitatively in accord with Jakowkin's hypothesis of the presence of tri-iodides except that in concentrated solutions deviations are observed which he suggests are most likely due to the simultaneous formation of small amounts of a more complicated polyiodide.

Measurements similar to those of Noyes and Seidensticker have been made by Bray and MacKay at 25°C. with greater precision, covering the range 0.001 N KI to 0.1 N KI. Their results, like Jakowkin's, show an apparent decrease in the equilibrium constant in the stronger KI solutions from 0.00150 in 0.001 N KI to 0.00131 in 0.1 N KI solutions. They suggest that this indicates that appreciable amounts of more complex polyiodides are formed in the more concentrated solutions in addition to the tri-iodide but they make no attempt to determine the exact formula of the higher polyiodide. Bray and MacKay also measured the electrical conductivity of these saturated solutions and concluded that the degree of ionization of KI<sub>3</sub> is substantially the same as that of KI at corresponding concentrations and that the mobility of the tri-iodide ion (I<sub>3</sub><sup>-</sup>) is 41.0 (K<sup>+</sup> = 74.8 and I<sup>-</sup> = 76.5). The ratio of mobility of the tri-iodide ion to that of the iodide ion is 0.54 according to these figures, which agrees within the limit of error with the result 0.566 of Burgess and Chapman obtained by an entirely different method.

Bray<sup>2</sup> found that when iodine is dissolved in pure water the reaction  $I_2 + H_2O = H^+ + I^- + HIO$  occurs to a slight extent and that after correcting the measured solubility for iodine dissolved by this reaction, the true solubility of I<sub>2</sub> as such is 0.00132 at 25°C. The hydrolysis of iodine is negligible in solutions containing moderate amounts of either hydrogen ion or iodide ion.

The equilibrium constant has been obtained at 0°C., 20° and 40° by Fedotieff<sup>3</sup> by a very different method. Fedotieff was interested primarily in the study of the equilibrium in the reaction  $2 Cu^+ + I_2 = 2 Cu^{++} + 2 I^-$  but in order to interpret his data on this equilibrium quantitatively he found it necessary to make allowance for the complication due to the formation of

<sup>1</sup> A. P. Laurie: *Z. physik. Chem.*, **67**, 627 (1909).

<sup>2</sup> W. C. Bray: *J. Am. Chem. Soc.*, **32**, 932 (1910); **33**, 1485 (1911).

<sup>3</sup> Fedotieff: *Z. anorg. Chem.*, **69**, 31 (1911).

tri-iodides. From his data it may be computed that the equilibrium constant

$$\frac{I^- \times I_2}{I_3^-} = 0.000735 \text{ at } 0^\circ\text{C.}; \text{ and } 0.001194 \text{ at } 20^\circ; \text{ and } 0.001751 \text{ at } 40^\circ.$$

Washburn and Strachan<sup>1</sup> have determined the equilibrium constant in hydriodic acid and found a slightly lower value—0.00130—at 25°C. These experiments were carried out incidentally in the course of an experimental determination of the equilibrium constant of the oxidation of arsenious acid by iodine to give arsenic acid and hydriodic acid. In the interpretation of their data they found it necessary to make due allowance for the formation of the tri-iodide ion, I<sub>3</sub><sup>-</sup>.

Jones and Hartmann<sup>2</sup> have made a study at 0°C. similar to that of Bray and MacKay at 25°C. with analogous results. In solutions saturated with iodine the amount of tri-iodide formed is nearly equal to the remaining iodide. They found the solubility of iodine at 0°C. to be 0.0006383 moles I<sub>2</sub> per liter, or after correction for hydrolysis 0.000635 moles I<sub>2</sub> per liter. The decrease in the equilibrium constant at the higher concentrations of potassium iodide saturated with iodine was also observed but is less pronounced at 0°C. than at 25°C. The equilibrium constant changes from 0.000718 in dilute solutions to 0.000686 in 0.1 N KI. This indicates that there is lesser tendency for higher polyiodides to be formed at 0° than at 25°C. Jones and Hartmann also found that at 0°C., when a 0.1 N KI solution is saturated with iodine, the conductivity decreases by 12.5%, whereas the viscosity increases only 1.3%. The decreased conductivity cannot, therefore, be accounted for on the hypothesis that potassium and iodide ions are slowed down by the increased viscosity due to the presence of dissolved I<sub>2</sub>. But the lowered conductivity can be accounted for on the hypothesis that about half the original iodide ion of mobility 43.4 at 0° is converted into a heavier and larger tri-iodide ion of mobility 22.8.

Van Name and Brown<sup>3</sup> have made studies similar to those of Jakowkin using SrI<sub>2</sub>, ZnI<sub>2</sub>, NiI<sub>2</sub>, LaI<sub>3</sub> and obtained the same value for the equilibrium constant,

$$\frac{\sum I}{\sum I_3} \times I_2 = 0.00140 \text{ at } 25^\circ, \text{ as Jakowkin and others, which they regard}$$

as supporting Jakowkin's theory of the process. They found, however, that when using a solution of CdI<sub>2</sub>; CdI<sub>2</sub>, 2KI; and HgI<sub>2</sub>.2KI no constant could be obtained by the same method of calculation as in the other cases mentioned which supports the other available evidence that these salts form complex anions.

The vague suggestion of Bray and MacKay that a higher polyiodide may be present in addition to the tri-iodide was made more definite by Linhart.<sup>4</sup> He measured the solubility of iodine in potassium iodide solutions at concentrations between those studied by Bray and MacKay and by Parsons and Whittemore. Since a solid KI<sub>7</sub> has been observed by Abegg and Hamburger<sup>5</sup>

<sup>1</sup> E. W. Washburn and E. K. Strachan: *J. Am. Chem. Soc.*, **35**, 681 (1912).

<sup>2</sup> Grinnell Jones and M. L. Hartmann: *J. Am. Chem. Soc.*, **37**, 241 (1915).

<sup>3</sup> R. G. Van Name and W. G. Brown: *Am. J. Sci.*, [4] **46**, 105 (1917).

<sup>4</sup> G. A. Linhart: *J. Am. Chem. Soc.*, **40**, 162 (1918).

<sup>5</sup> R. Abegg and A. Hamburger: *Z. anorg. Chem.*, **50**, 427 (1906).

and also by Foote and Chalker and a polyvalent complex is indicated by the data, Linhart assumes that the solid is really  $K_2I_{14}$  and that the reaction  $2I^- + 6I_2 \rightleftharpoons I_{14}^{2-}$  occurs in solution in addition to the reaction  $I^- + I_2 \rightleftharpoons I_3^-$ . Surprisingly concordant values of the equilibrium constant of this reaction are computed by Linhart from the solubility data referred to above, and the data of Bray and MacKay and of Parsons and Whittemore.

This hypothesis thus accounts quantitatively for the variation of the solubility of iodine with variation in concentration of potassium iodide and also for the apparent variation in the values of the equilibrium constant of the reaction  $I + I_2 \rightleftharpoons I_3^-$  observed by Jakowkin, by Bray and MacKay and by Jones and Hartmann. It is evident that on dilution the complex  $I_{14}^{2-}$  would dissociate thus dropping its load of iodine, so that this hypothesis is in harmony with the fact that strong solutions of potassium iodide saturated with iodine will precipitate iodine on dilution. Although Linhart does not point it out, it is apparent that the occurrence of the reaction  $2I^- + 6I_2 \rightleftharpoons I_{14}^{2-}$  also accounts for the rise in freezing point on adding iodine to a potassium iodide solution which has been emphasized by Parsons. Thus the properties which Parsons has shown to be thermodynamically related and which he argues disprove the existence of tri-iodides or of any polyiodide in solution really prove the existence of a more complex polyvalent polyiodide which is shown by Linhart's equilibrium calculations to be  $I_{14}^{2-}$ . The amount of this polyiodide present is small in comparison with the tri-iodide in dilute solutions (say 0.1 normal and under) especially if unsaturated with iodine. But since the amount of  $I_{14}^{2-}$  would increase as the square of the concentration of the iodide ion present and as the sixth power of the free iodine ( $I_2$ ) it becomes of great importance in the higher concentrations.

The equilibrium  $I^- + I_2 \rightleftharpoons I_3^-$  has recently been studied by Jones and Kaplan<sup>1</sup> as a necessary preliminary step in the determination of the normal potential of the iodine-iodide electrode and the measurement of the free energy of a reaction in which iodine takes part. In order to avoid errors due to the presence of  $I_{14}^{2-}$  it was desirable to work with solutions unsaturated with iodine. But the amount of tri-iodides present can not be made negligible by this means and it was therefore necessary to evaluate quantitatively the effect on the measured potential of the formation of tri-iodide. All earlier studies of the equilibrium in solutions unsaturated with iodine have been based on distribution experiments with some other solvent such as carbon bisulfide or carbon tetrachloride. This procedure is however not well suited for precision work because the nonaqueous solvent has a much greater solvent power for iodine than water and therefore a trace of solvent emulsified in the aqueous layer can make a serious error in the analysis. They invented a new device in which the distribution ratio of iodine between water and solutions of potassium iodide was determined by bringing them to equilibrium through the vapor phase. The results show a good constancy of the equilibrium constant in spite of considerable variations in the concentration of both iodine and iodide up to  $1/3$  normal KI and  $1/3$  saturation with iodine.

<sup>1</sup> Grinnell Jones and B. B. Kaplan: J. Am. Chem. Soc., 50, 1600, 1845 (1928).

Table II gives the most probable value of the equilibrium constant  $\frac{I^- \times I_2}{I_3^-}$  at various temperatures.

	k		k
0° Jones and Kaplan	0.000718	20° Fedotieff	0.00119
13.5° Dawson	0.00101	25° Jakowkin, Jones Kaplan	0.00140
15° Dawson	0.00103	40° Fedotieff	0.00175
18° Dawson	0.00115		

When  $\log k$  is plotted against  $1/T$  these results fall approximately on a straight line, thus showing a normal variation of the equilibrium constant with the temperature.

Johnson<sup>1</sup> evaporated solutions of iodine and potassium iodine over sulfuric acid and obtained lustrous dark prismatic crystals, some of which were two inches long which were proved by analyses to have the composition represented by  $KI_3$ . He also determined the density of these crystals to be 3.498, which corresponds to a molecular volume of 120.1 cc. Whereas the molecular volume of  $KI$  is 54.3 cc. and of  $I_2$  is 51.34cc., making a total of 105.64 cc. Therefore, unless Johnson made an error of nearly 15% in the determination of the density of his crystals, they could not have been a mixture of potassium iodide and iodine. He found the melting point to be 45°C. Wells, Wheeler and Penfield<sup>2</sup> also prepared solid  $KI_3$  and determined the crystal angles and showed that it is monoclinic and determined the melting point to 38°C. Foote and Chalker obtain evidence of the formation of solid  $KI_3$  from Phase Rule studies of the system  $KI - I_2 - H_2O$ . Clark and Duane<sup>3</sup> have prepared solid crystals of  $KI_3$  and confirm the observation of Wells and Penfield that it belongs to the monoclinic system and have studied the structure of the crystal by means of X-ray analysis with results proving that their crystals were not merely a mixture of  $KI$  and  $I_2$ . It should be noted, however, that Johnson is the only one of these investigators who reports analyses of the pure crystals.

But in spite of this definite and circumstantial evidence of the existence of solid  $KI_3$ , Abegg and Hamburger, Parsons and Corliss, Parsons and Whittemore, and Bancroft<sup>4</sup> deny the existence of solid  $KI_3$  at 25°C. on the basis of Phase Rule studies of the system  $KI-I_2-H_2O$ . Abegg and Hamburger and Foote and Chalker<sup>5</sup> state that a higher complex having the formula  $KI_7$  exists in the solid state at 25°C., whereas Parsons and his collaborators deny the existence of any solid polyiodides of potassium at 25°C.

<sup>1</sup> G. S. Johnson: J. Chem. Soc., 31, 249 (1877).

<sup>2</sup> H. L. Wells, H. L. Wheeler and S. L. Penfield: Z. anorg. Chem., 1, 442 (1892).

<sup>3</sup> G. L. Clark and W. Duane: J. Optical Soc. America, 7, 472 (1923).

<sup>4</sup> W. D. Bancroft: oral statement before the Division of Physical Chemistry at the Swampscott meeting of the American Chemical Society, Sept. 1928.

<sup>5</sup> H. W. Foote and W. C. Chalker: Am. Chem. J., 39, 561 (1908).



Berthelot<sup>1</sup> obtained crystals which he believed to be  $KI_3$  but he found the heat of solution of these crystals to be the same as the heat of solution of equivalent quantities of  $KI$  and  $I_2$  in the same amount of water, which indicates but does not necessarily prove that his crystals were a mixture rather than a compound.

There are numerous references in the literature describing complex solid polyiodides of rubidium, cesium,<sup>2</sup> ammonium and organic bases.

There is thus an irreconcilable conflict of evidence in the literature as to the existence of solid  $KI_3$ . There are reports of four independent investigations in which it is claimed that solid  $KI_3$  was obtained and in one or more of these researches the chemical analysis, density, melting point, crystal system and crystal angles, and internal structure as deduced from X-ray analyses were determined. On the other hand, there are four separate investigations based on Phase Rule studies of the system  $KI-I_2-H_2O$  in which no evidence of the occurrence of  $KI_3$  was found. The reviewer gives greater weight to the definite circumstantial positive evidence of the existence of solid  $KI_3$  than to the negative evidence of those investigators who failed to find it. But even if it should eventually be definitely determined that  $KI_3$  is unstable at  $25^\circ C.$ , this fact—if it be a fact—would merely indicate that the vapor pressure of iodine from solid  $KI_3$  exceeds that of pure iodine at  $25^\circ C.$  but would not disprove the existence of tri-iodide ions in solution. Evidence as to the existence of solid tri-iodides of cesium, rubidium and ammonium seems to be undenied. On the other hand, so far as the reviewer is aware, no one claims to have produced solid  $LiI_3$  or  $NaI_3$ .

However interesting the question of the stability of solid  $KI_3$  at  $25^\circ C.$  or even existence of this substance at any temperature may be for its own sake, the question of the existence of tri-iodide ions in solution will have to be decided on other grounds.

There have been many attempts to interpret the significance of the color of iodine solutions beginning with the statement of Gay-Lussac, quoted on a previous page. Only a few of these can be referred to here.<sup>3</sup>

Iodine—as is well known—dissolves in some solvents, including carbon tetrachloride, carbon bisulphide, chloroform, and bromoform, with a violet or reddish violet color like the color of iodine vapors. In other solvents it gives red, reddish brown, or yellow solutions, depending on the solvent, concentration, and temperature.

Beckmann and his coworkers have found that in all solvents the molecular weight of dissolved iodine corresponds to the formula  $I_2$  and Beckmann<sup>4</sup> has expressed the opinion that in the brown solutions there is a chemical combination of the iodine with the solvent. Lachman<sup>5</sup> supports this posi-

<sup>1</sup> M. Berthelot: *Compt. rend.*, **90**, 841 (1880).

<sup>2</sup> J. W. Mellor: "A Comprehensive Treatise on Inorganic and Theoretical Chemistry," **2**, page 609 ff. (1922).

<sup>3</sup> See Kayser: "Handbuch der Spektroskopie," **3**, 324, for a fuller discussion with many additional references.

<sup>4</sup> E. Beckmann: *Z. physik. Chem.*, **5**, 76 (1890); **17**, 107 (1895); **58**, 543 (1907).

<sup>5</sup> A. Lachman: *J. Am. Chem. Soc.*, **25**, 50 (1903).

tion and concludes from the examination of scores of cases that "saturated solvents give violet, solvents which have unsaturated character give brown solutions." He points out that brown solutions tend to become violet when heated owing to thermal dissociation of addition compounds. Hildebrand and Glascock<sup>1</sup> have demonstrated by freezing point measurements that there is a chemical combination between iodine and several solvents which give brown solutions, and no combination in several solvents giving violet solutions.

Piccard<sup>2</sup> has found that this change from violet to brown is caused by many nitrogenous organic bases and by organic compounds of oxygen and has used this reaction (in the absence of nitrogenous bases) as a qualitative test for oxygen in organic compounds. He has also found (private communication, as yet unpublished) that the brown solutions obtained by adding a trace of nitrogenous base to a violet solution may be changed to violet by the addition of an acid. He believes the violet color to be due to free iodine,  $I_2$ , and the appearance of a reddish brown color to indicate the formation of an addition compound.

A solution of iodine in pure water is reddish violet and when potassium iodide is added in excess it changes color in a very obvious and unmistakable manner to a yellow, thus indicating that a chemical reaction is occurring between the added iodide and the free iodine. Tinkler<sup>3</sup> has photographed the absorption spectra of an aqueous solution of iodine and of potassium iodide and of a solution containing both iodine and potassium iodide and finds that the latter contains two absorption bands in the ultraviolet which are not given by either iodine or potassium iodide alone. He regards this as proof of the formation of a periodide (tri-iodide).

Additional evidence of the existence of tri-iodide ion of an entirely different nature from that quoted above is given by research on the velocity of reactions in which iodine and iodides are among the factors or the products. Owing to the unavoidable complexity of the interpretation of the kinetics of reactions and the great number of papers in this field, no attempt will be made to give a detailed analysis of the evidence or a complete list of references. Among the earliest of the careful investigations of this kind is the work of Donnan and Le Rossignol<sup>4</sup> on the oxidation of iodides by ferricyanides. These authors say:

"These results show that the velocity-coefficient  $K$  varies directly as the cube of the concentration of the iodine ions. This rather unexpected result points to the formation of complex  $I_3^-$  ions in the primary reaction, and accordingly this change must be represented by the equation:

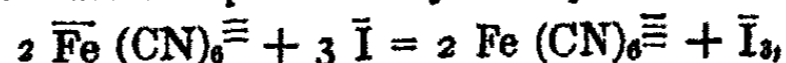

and not by the successive equations:

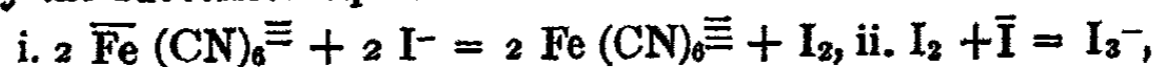

<sup>1</sup> J. H. Hildebrand and B. L. Glascock: *J. Am. Chem. Soc.*, 31, 26 (1909).

<sup>2</sup> J. Piccard: *Helv. chim. Acta*, 5, 243, 625 (1922).

<sup>3</sup> C. K. Tinkler: *J. Chem. Soc.*, 91, 996 (1907).

<sup>4</sup> F. G. Donnan and R. LeRossignol: *J. Chem. Soc.*, 83, 703 (1903).

where the second equation represents a reaction which proceeds with very great speed in comparison with that represented by the first. Judging from the generally observed simplicity in the mechanism of chemical reactions, the latter hypothesis appeared to be more natural. It is, however, entirely negatived by the foregoing results. The primary formation of such complex halogen ions (or the corresponding undissociated compounds) has been already detected in kinetic investigations. Thus in the bromination of benzene in presence of iodine, L. Bruner<sup>1</sup> found that the reaction was *quadrimeric* with respect to bromine, according to the equation:

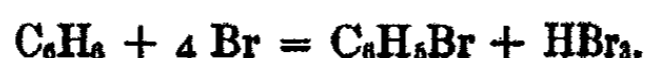

"In an investigation of the action of bromine on alcohol in which the following change occurs,

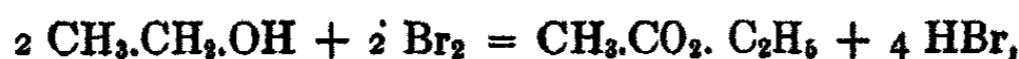

S. Bugarsky<sup>2</sup> found it necessary to take into account the formation of  $\text{HBr}_3$  in the establishment of an equation to express the speed of the reaction.

"Other investigations dealing with chemical equilibrium have conclusively proved the existence of complex  $\text{I}_3^-$  ions in solution. The foregoing instances, together with the results obtained in the present investigation, indicate the primary part played by these complexes in the kinetics of chemical reaction."

On the other hand the conclusion reached by Donnan and LeRossignol as to the mechanism of the reaction between ferricyanide and iodide ions is not supported by Just,<sup>3</sup> or by Wagner<sup>4</sup> who do not find it necessary to assume the primary formation of triiodide ions to account for their own observations on the velocity of this reaction. The equilibrium of this reaction has been studied by LaMer and Sandved<sup>5</sup> and by LaMer and Friedman,<sup>6</sup> who find that due allowance must be made for the presence of tri-iodide ions in the equilibrium mixture in order to compute an equilibrium constant for the reversible oxidation of iodides by ferricyanides.

Another pertinent investigation is that of Dushman<sup>7</sup> on the velocity of the reaction between iodic and hydriodic acids. Dushman interprets his measurement of the kinetics of this reaction as evidence that the two reactions,  $2 \text{ I}^- + 2 \text{ H}^+ + \text{IOI}_3^- = 2 \text{ HOI} + \text{IO}^-$ , and  $\text{I}^- + \text{I}_3^- + 2 \text{ H}^+ + \text{IO}_3^- = \text{HOI} + \text{HOI}_2 + \text{IO}^-$  are occurring simultaneously.

Skrabal<sup>8</sup> has studied with great care the reverse reactions; namely, the action of alkalis ( $\text{OH}^-$ ) on iodine to form iodate and iodide with the formation of hypoiodite as an intermediary step and regards his data as proof that the

<sup>1</sup> Bull. Acad. Sci. Cracovie, 1902, 3, 1905; Abstr., 1902 II, 447.

<sup>2</sup> Z. physik. Chem., 42, 545 (1903).

<sup>3</sup> G. Just: Z. physik. Chem., 63, 513 (1908).

<sup>4</sup> C. Wagner: Z. physik. Chem., 113, 261 (1924).

<sup>5</sup> V. K. LaMer and K. Sandved: J. Am. Chem. Soc., 50, 2656 (1928).

<sup>6</sup> V. K. LaMer and H. B. Friedman: J. Am. Chem. Soc., 52, 876 (1930).

<sup>7</sup> S. Dushman: J. Phys. Chem., 8, 453 (1904).

<sup>8</sup> A. Skrabal: Monatsheft, 32, 815 (1911).

tri-iodide ion is present and takes part in the slow steps of the reaction which control the velocity.

King and Jette<sup>1</sup> have studied the velocity of the oxidation of iodides by persulphate from which they draw the conclusion "These calculations demonstrate conclusively that the observed reaction velocity is the sum of the velocities of two reactions—the first involving the iodide ions and the second the tri-iodide ions, and, furthermore, that the tri-iodide ion reacts at approximately one-half the rate of the iodide ion."

Then in a second paper<sup>2</sup> they study the effect on the velocity of the reaction of removing the reaction products and conclude "Finally, the main conclusion of the first article, that is, that the observed reaction velocity is the sum of the velocities of the iodide and of the tri-iodide ions reacting with the persulfate ion, was confirmed by measurements at considerably greater velocities."

Finally it remains to consider the measurements of the normal potential of the iodine-iodide electrode. These measurements have especial importance for our purpose because they permit a comparative quantitative test of Jakowkin's and of Parsons' idea of the nature of solutions containing iodine and potassium iodide. The iodine-iodide electrode ranks among the most definite, constant, reproducible, and easily reversible of electrodes. Some discussion and comparison of these investigations will be found in the paper of Jones and Kaplan.<sup>3</sup> For the present purpose it is only necessary to point out that all of these investigators, with the single exception of Gerke,<sup>4</sup> in the computation of the normal potential made allowance for the presence of the tri-iodide in the solutions used in their investigations. Gerke avoids the necessity of computing the effect of the presence of tri-iodide by a clever experimental device. He measured the potential of a cell Pb (Hg), PbI<sub>2</sub>,

TABLE III

Summary of the results of all measurements of the normal potential of the iodine-iodide electrode since 1900:

F. Crotonino	Z. anorg. Chem., 24, 247 (1900)	-0.256
V. Sammet	Z. physik. Chem., 53, 674 (1905)	- .256
W. Maitland	Z. Elektrochemie, 12, 263 (1906)	- .2569
G. Jones and W. C. Schumb	Proc. Am. Acad., 56, 226 (1921)	- .2555
A. McKeown	Proc. Faraday Soc., 17, 517 (1922)	- .2454
R. H. Gerke	J. Am. Chem. Soc., 44, 1703 (1922)	- .2531
G. N. Lewis and M. Randall	"Thermodynamics," 428 (1923)	- .2539
G. N. Lewis and M. Faragher	Not published in detail (1923)	- .2539
H. D. Murray	J. Chem. Soc., 127, 882 (1925)	- .2535
G. Jones and B. B. Kaplan	J. Am. Chem. Soc., 50, 2075 (1928)	- .2544

<sup>1</sup> C. V. King and E. R. Jette: J. Am. Chem. Soc., 51, 1047 (1929).

<sup>2</sup> C. V. King and E. R. Jette: J. Am. Chem. Soc., 51, 1057 (1929).

<sup>3</sup> Grinnell Jones and B. B. Kaplan: J. Am. Chem. Soc., 50, 2068 (1928).

<sup>4</sup> R. H. Gerke: J. Am. Chem. Soc., 44, 1703 (1922).

$\text{Pb}(\text{ClO}_4)_2 + \text{HClO}_4, \text{PbI}_2, \text{I}_2, \text{Pt}$ . In this cell liquid junction corrections are negligible and when the cell operates there is no change in the concentration of the electrolyte and, therefore, the cell gives directly the free energy of the reaction  $\text{Pb}(\text{Hg}) + \text{I}_2 = \text{PbI}_2$ . By correcting this result for the difference between lead amalgam and pure lead and combining it with measurements of Lewis and Brighton<sup>1</sup> on a cell  $\text{Pb}, \text{PbI}_2, 0.1 \text{ N KI}; \text{N.E.}$  with proper allowance for the activity of the iodide in this solution the normal potential of the iodine-iodide electrode is found to be  $-0.2531$  as given in the table.<sup>2</sup> This result differs from that of Jones and Kaplan by only 1.3 millivolts but 0.4 millivolts of this difference is due to a variation in the definition of the normal calomel electrode so that the real difference is only 0.9 millivolts. Since the method used by Gerke is so radically different from that used by all of the other investigators referred to, the agreement of the results within about a millivolt gives strong support to the views of these investigators that due allowance must be made for the presence of the tri-iodide iodine in interpreting measurements of the potential of iodine-iodide electrodes.

In order to test this matter further, I give in Table IV a comparison of values of the normal potential computed from the same data first with proper allowance for the presence of tri-iodides and secondly on the supposition that tri-iodides are not formed but that all the dissolved iodine found by an iodometric titration is free and electromotively active as  $\text{I}_2$ . For this purpose I select the data of Jones and Kaplan at  $25^\circ\text{C}$ . The first column gives the

TABLE IV  
Normal Potential of Iodine at  $25^\circ$

Conc.	Total Dissolved Iodine	Free Iodine	Normal Potential Computed with allowance for $\text{I}_3$	Normal Potential Computed without allowance for $\text{I}_3$
0.100,0	0.008,246	0.000,124,13	-0.254,39	-0.202,32
0.100,0	0.004,865,5	0.000,070,864	-0.254,39	-0.201,20
0.049,94	0.012,496	0.000,441,3	-0.254,35	-0.218,06
0.049,77	0.002,670	0.000,076,47	-0.254,46	-0.210,80
0.049,98	0.001,153,4	0.000,031,518	-0.254,36	-0.209,59
0.050,00	0.001,136,4	0.000,031,11	-0.254,35	-0.209,59
0.020,00	0.002,366,8	0.000,174,5	-0.254,77	-0.225,54
0.020,00	0.001,194	0.000,083,53	-0.254,23	-0.223,12
0.010,00	0.006,185	0.001,32	-0.254,34	-0.250,84

concentration of potassium iodide solution used. The second column gives the concentration of total dissolved iodine as determined by titration with arsenious acid. The third column gives the concentration of free ( $\text{I}_2$ ) as determined by distribution with pure water through the vapor phase with the

<sup>1</sup> G. N. Lewis and T. B. Brighton: *J. Am. Chem. Soc.*, **39**, 1906 (1917).

<sup>2</sup> G. N. Lewis and M. Randall, "Thermodynamics and the Free Energy of Chemical Substances," p. 430 (1923).

Jones and Kaplan equilibrators. The fourth column gives the normal potential as computed by Jones and Kaplan with allowance for the presence of tri-iodides as is explained in detail in their original paper. The last column gives the normal potential computed from the same data as and if no tri-iodide is formed, but otherwise exactly like the calculations of Jones and Kaplan. As will be seen when proper allowance is made for the occurrence of tri-iodides, the results agree very well among themselves and the slight deviations are unsystematic and therefore may be ascribed to experimental errors. On the other hand the results when computed on the hypothesis that tri-iodides do not exist show large deviations among themselves and a systematic variation with the concentrations, which indicates that the deviations are not due to experimental errors but to a mistaken or inadequate theoretical interpretation. Moreover, the results are not in agreement with that of Gerke. The evidence of these potential measurements thus lends strong support to the hypothesis that tri-iodide ions are present.

#### Summary

The hypothesis that iodine and iodides react in aqueous solution to form a negative tri-iodide ion ( $I_3^-$ ) in reversible equilibrium in accordance with the reaction  $I^- \times I_2 \rightleftharpoons I_3^-$  is supported by evidence of a varied character including:

(1) The solubility of iodine in water is very low (0.001,34 moles  $I_2$  at  $25^\circ\text{C}$ .) but is greatly increased by the addition of any soluble iodide, approximately  $1/2$  mol  $I_2$  per mol soluble iodide in dilute solution, and in greater ratio in concentrated solutions.

(2) The iodine can be removed completely by extraction with a suitable solvent or by an indifferent gas.

(3) The freezing point of a potassium iodide solution instead of being further depressed by the addition of iodine is slightly raised.

(4) The equilibrium constant,  $\frac{I^- \times I_2}{I_3^-}$ , has been found by many experimenters using divers methods to be 0.001,40 at  $25^\circ\text{C}$ . The equilibrium constant has also been measured at several other temperatures over the range  $0^\circ$  to  $40^\circ\text{C}$ . and varies with the temperature in a normal manner.

(5) The electrical conductivity of a potassium iodide solution is lowered by dissolving iodine therein, the reduction being about 12% in solutions saturated with iodine. The change cannot be accounted for by the increased viscosity which amounts to less than 1% in solutions not exceeding 0.1 n KI, nor by the hypothesis of a diminished degree of dissociation. It can be accounted for by the conversion of the iodide ion  $I^-$  into a less mobile tri-iodide ion,  $I_3^-$ .

(6) It has been found that dissolved iodine migrates to the anode when a direct current is passed through the solution, thus proving it to be a part of a negative ion.

(7) Computations of the mobility of the tri-iodide ion from measurements of electrolytic transference agree with the mobility determined by conductivity measurements.

(8) Solid tri-iodides of rubidium, of cesium, and of ammonium have been reliably reported and their existence remains unquestioned. The existence of solid potassium tri-iodide has been reported in four independent investigations with much circumstantial detail, including analyses and measurements of density, melting point, crystal angles and crystal structure. Nevertheless, the stable existence of solid  $KI_3$  at  $25^\circ C.$  is denied as a result of four independent Phase Rule investigations of the system  $KI, I_2, H_2O$ .

(9) There is evidence of a diverse character that violet solutions of iodine contain free iodine,  $I_2$ , whereas solutions of other colors, usually reddish brown, contain addition compounds of iodine with the solvent or some other solute.

(10) An aqueous solution containing iodine and an iodide gives two absorption bands in the ultraviolet which are not given by either iodine or potassium iodide alone.

(11) There are several cases in which measurements of the velocity of chemical reactions in which iodine and iodides are among the factors or products have shown that the tri-iodide ion plays a part in the indicated mechanism of the reaction.

(12) Experiments on diffusion in solutions containing iodides and free iodine although interpreted by the original authors as showing the absence of tri-iodides are shown in this paper to be capable of interpretation on the hypothesis of the presence of tri-iodides.

(13) Measurements of the potential of iodine-iodide electrodes can only be interpreted to give a definite normal potential independent of the concentrations of the solutions used by making proper allowance for the presence of tri-iodides.

Those who argue against the existence of tri-iodides in solution base their arguments on the alleged non-existence of solid  $KI_3$  at  $25^\circ C.$ , and on an interpretation of the slight rise in freezing point which occurs when iodine is added to solutions of potassium iodide, and on an interpretation of some diffusion experiments. It is shown in this review that these arguments are fallacious.

There is some evidence that relatively small amounts of a still more complex polyiodide, possibly  $I_{14}^-$ , is formed, especially in concentrated solutions of potassium iodide saturated with iodine.

*Mallinckrodt Laboratory,  
Harvard University,  
Cambridge, Massachusetts.*

## THE SOLUBILITY OF FERROUS SULPHATE

BY FRANK K. CAMERON

*Non-aqueous Solvents.* Ferrous sulphate is not soluble in ammonia,<sup>1</sup> carbon dioxide,<sup>2</sup> alcohol,<sup>3</sup> glacial acetic acid, methyl acetate,<sup>4</sup> or ethyl acetate.<sup>5</sup> It is slightly soluble in sulphuric acid,<sup>6</sup> a saturated solution containing 0.22 percent FeSO<sub>4</sub> at 30.2°C and 0.63 percent at 63.8°C. The solid phase in contact with these solutions contains both ferrous and hydrogen sulphates but in undetermined proportions. Similar solids containing ferrous sulphate and hydrogen sulphate or ferrous sulphate, hydrogen sulphate, and water have been prepared.<sup>7</sup> The limits of concentration of sulphuric acid between which the several solids are stable, have been determined, but not their solubilities.

*Various Properties.* Ferrous sulphate is quite soluble in water, and with noticeable contraction.<sup>8</sup> Extensive tables have been prepared of the specific heats of its solutions in water and aqueous sulphuric acid,<sup>9</sup> the boiling points<sup>10</sup> of aqueous solutions of varying composition, and the specific gravities<sup>11</sup> at 15°C. Agde and Barkholt<sup>12</sup> have determined the specific gravities of saturated solutions from one degree to 80°C. At this last temperature it is 1.367. At 54°, a short way below the transition temperature of the heptahydrate to the tetrahydrate, the specific gravity of the saturated solution is 1.432 and it falls continuously to 1.114 at one degree. The electrical conductivity of aqueous solutions at 25°C. has been determined by Wagner.<sup>13</sup> The dielectric constant<sup>14</sup> has been found to decrease and then rise with increasing content of ferrous sulphate. The surface tension of water is slightly increased by dissolving ferrous sulphate.<sup>15</sup> The solutions are more or less toxic, and have been used as insecticides, fungicides, weed killers, etc. Ferrous sulphate is but slightly toxic to fish.<sup>16</sup> The solutions are astringent and have been employed as coagulants and as a primer before painting resinous woods.<sup>17</sup>

<sup>1</sup> Franklin: Am. Chem. J., 20, 828 (1898).

<sup>2</sup> Büchner: Z. physik. Chem., 54, 674 (1905).

<sup>3</sup> Anthon: J. prakt. Chem., 14, 125 (1838).

<sup>4</sup> Naumann: Ber., 42, 3790 (1909).

<sup>5</sup> Naumann: Ber., 37, 3601 (1904).

<sup>6</sup> Kendall and Davidson: J. Am. Chem. Soc., 43, 979 (1921).

<sup>7</sup> Kenrick: J. Phys. Chem., 12, 704 (1908).

<sup>8</sup> Rakschit: Z. Electrochemie, 31, 97 (1925); 32, 276 (1926).

<sup>9</sup> Agde and Holtmann: Z. anorg. allgem. Chem., 158, 316 (1926).

<sup>10</sup> Gerlach: Z. anal. Chem., 26, 426 (1887).

<sup>11</sup> Gerlach: Z. anal. Chem., 8, 287 (1869).

<sup>12</sup> Z. angew. Chem., 39, 851 (1926).

<sup>13</sup> Z. physik. Chem., 71, 429 (1910).

<sup>14</sup> Hellman and Zahn: Ann. Physik, 81, 711 (1926).

<sup>15</sup> Stocker: Z. physik. Chem., 94, 149 (1920).

<sup>16</sup> Belding: Trans. Am. Fish Assoc., 57, 110 (1927).

<sup>17</sup> Brooke: Philipp. J. Sci., 30, 303 (1926).



Solutions show the phenomena of creeping but to a slight extent as compared to those of many other salts.<sup>1</sup> Ferrous sulphate heptahydrate effloresces. In water, ferrous sulphate hydrolyzes and the determination of the "free acidity" has received much attention in recent years, electrometric titration seeming to be favored.<sup>2</sup> In the order of the salting out of ions,<sup>3</sup>  $\text{Fe}^{++}$  lies between Mg and Zn. In contact with zeolites or soil minerals,  $\text{Fe}^{++}$  in aqueous solutions of ferrous sulphate is displaced<sup>4</sup> by Ca. It is also displaced<sup>5</sup> readily by Ba, but not by Be.

*Oxidation.* In aqueous solution ferrous sulphate is readily, and sometimes annoyingly, oxidized by air. Jilek<sup>6</sup> finds no oxidation at the end of forty-eight hours if sulphuric acid be present. Banerjee<sup>7</sup> finds the oxidation by air to be slow, an unimolecular reaction, approximately, hastened by the presence of potassium sulphate but retarded by all other sulphates, particularly sulphuric acid and copper sulphate. Reedy and Machen<sup>8</sup> find the oxidation to be slow, to fall off gradually, but to be positively catalyzed by pyrolusite ( $\text{MnO}_2$ ). This last fact is the basis of patents and commercial practice. Potassium permanganate, potassium dichromate, iodine chloride<sup>9</sup> ( $\text{ICl}$ ) are readily reduced, and their solutions are mediums for the analytical estimation of ferrous sulphate. Chlorine<sup>10</sup> is used commercially as is also sodium peroxide. The reaction with hydrogen peroxide is not well understood. Manchot and Lehmann<sup>11</sup> find that in dilute solutions of ferrous sulphate one  $\text{Fe}^{++}$  is equivalent to  $3\text{H}_2\text{O}_2$ , probably  $\text{Fe}_2\text{O}_3$  being formed; while, in concentrated solutions, one  $\text{Fe}^{++}$  may be equivalent to as much as  $24\text{H}_2\text{O}_2$ . In acid solutions ferrous sulphate is oxidized by X-rays irrespective of the wave length.<sup>12</sup> It induces the oxidation of other substances, and is important for various autoxidations as with glycolic acid by hydrogen peroxide.<sup>13</sup>

From the literature it appears that the best way to prevent oxidation of ferrous sulphate or its solutions is to keep them in contact with hydrogen. Some investigators have found an atmosphere of nitrogen satisfactory. Contact with iron wire or nails is unsatisfactory. A layer of nujol has been moderately successful for a few days, but not over a period of weeks. Satisfactory results have been attained by using water which has been long boiled for making solutions and keeping the solutions in contact with carbon dioxide.

<sup>1</sup> Druce: Pharm. J., 119, 333 (1927); Washburn: J. Phys. Chem., 31, 1246 (1927).

<sup>2</sup> Koenig: Chimie et Industrie, Special No. 187 (1926); Haczko: Z. anal. Chem., 73, 404 (1928); Kamienski: Bull. intern. Acad. Polonaise, 1928, 33.

<sup>3</sup> Randall and Failey: Chem. Reviews, 4, 285 (1927).

<sup>4</sup> Magistad: Arizona Agr. Exp. Sta., Tech. Bull. 18, 445 (1928).

<sup>5</sup> Bodfors: Z. physik. Chem., 130, 82 (1927).

<sup>6</sup> Chem. Listy, 15, 105; 138 (1921).

<sup>7</sup> Proc. Asiatic Soc. Bengal, 18, No. 6, 71 (1922); Z. anorg. allgem. Chem., 128, 343 (1923).

<sup>8</sup> Ind. Eng. Chem., 15, 1271 (1923).

<sup>9</sup> Heisig: J. Am. Chem. Soc., 50, 1687 (1928).

<sup>10</sup> Mohlman and Palmer: Eng. News Record, 100, 147 (1928).

<sup>11</sup> Ann., 460, 179 (1928).

<sup>12</sup> Fricke and Morse: Am. Jour. Roentgenology and Radium Therapy, 18, 426 (1927); Strahlentherapie, 26 749 (1927); Ber. ges. Physiol. expt. Pharmakol., 44, 336.

<sup>13</sup> Goldschmidt, Askenasy, and Pierros: Ber., 61, 223 (1928).

At higher temperatures an atmosphere of water vapor alone has proved quite sufficient to prevent noticeable oxidation over periods of several weeks, and at lower temperatures the presence of a few percent of alcohol has proved effective.

*Hydrates of Ferrous Sulphate.* At ordinary temperatures the heptahydrate,  $\text{FeSO}_4 \cdot 7\text{H}_2\text{O}$ , is the stable solid, separating from an aqueous solution as deep green, monoclinic crystals. Rhombic crystals<sup>1</sup> have been observed and can be induced by seeding the mother liquor with corresponding heptahydrates of other bases which crystallize in the rhombic system.<sup>2</sup> Westerbriek<sup>3</sup> by studying spectrograms found it to be monoclinic. It has a specific gravity of 1.889 according to Roscoe and Schorlemmer, quoting Joule and Playfair. Retgers<sup>4</sup> found it to be 1.898 at 18.0°C. In contact with its saturated aqueous solution it is stable from the cryohydrate point,  $-1.82^\circ\text{C}$ , to  $56.6^\circ\text{C}$ , according to Fraenckel,<sup>5</sup> the latter being a transition point at which the tetrahydrate becomes the stable form. Tilden<sup>6</sup> found the melting point of the heptahydrate to be  $64^\circ\text{C}$ . It loses water readily. Heated in vacuo at  $140^\circ\text{C}$  it is transformed to the monohydrate and on further gentle heating out of contact with the air, the anhydrous salt is formed. Liver-side<sup>7</sup> found heating in a water oven for 90 minutes left a residue containing 82.5%  $\text{FeSO}_4$ ; and Pritzer and Jungkuntz<sup>8</sup> found six molecules of water are removed when the heptahydrate is heated in xylene. Schumb<sup>9</sup> found that at  $25^\circ\text{C}$ . the dissociation pressure is 14.56 mm Hg for the transformation  $\text{FeSO}_4 \cdot 7\text{H}_2\text{O}$  to  $\text{FeSO}_4 \cdot 6\text{H}_2\text{O}$ . Cohen and Visser<sup>10</sup> are quoted by Jorissen<sup>11</sup> as having found 1.91 Kalories for the transformation:  $\text{FeSO}_4 \cdot 4\text{H}_2\text{O} + 3\text{H}_2\text{O} = \text{FeSO}_4 \cdot 7\text{H}_2\text{O}$ . The molecular volume of the salt and the hydrating water molecules were determined in the classical investigation of Thorp and Watts,<sup>12</sup> and recently by Moles and Crespi,<sup>13</sup> who found  $13.4 \text{ cm}^3$  for the first,  $16.3 \text{ cm}^3$  for the remaining water molecules.

The hexahydrate,  $\text{FeSO}_4 \cdot 6\text{H}_2\text{O}$ , is described by Lecoq de Boisbaudran,<sup>14</sup> and by Hensgen.<sup>15</sup> The former obtained it by seeding a solution of ferrous sulphate, slightly under-saturated with respect to  $\text{FeSO}_4 \cdot 7\text{H}_2\text{O}$ , with a crystal of cobalt sulphate crystallized at  $50^\circ\text{C}$ ,  $\text{CoSO}_4 \cdot 6\text{H}_2\text{O}$ . The compound

<sup>1</sup> Rammelsberg: Pogg. Ann., 91, 321 (1854); Volger: Jahrb. Mineralogie, 1855, 152.

<sup>2</sup> Roscoe and Schorlemmer: "Treatise on Chemistry", (1911).

<sup>3</sup> Verslag Akad. Wetenschappen, Amsterdam, 35, 1913; Proc. Acad. Sci. Amsterdam, 29, 1223 (1926).

<sup>4</sup> Z. physik. Chem., 3, 534 (1889).

<sup>5</sup> Z. anorg. Chem., 55, 223 (1907).

<sup>6</sup> J. Chem. Soc., 45, 267 (1884).

<sup>7</sup> Pharm. J., 118, 106; Chemist and Druggist, 106, 141 (1927).

<sup>8</sup> Chem. Ztg., 50, 962 (1926).

<sup>9</sup> J. Am. Chem. Soc., 45, 364 (1923).

<sup>10</sup> Arch. néerl., (2), 5, 300 (1900).

<sup>11</sup> Landolt and Börnstein: 3rd. Edition, 463, 1905; Z. physik. Chem., 74, 308 (1910).

<sup>12</sup> J. Chem. Soc., 37, 102 (1840).

<sup>13</sup> Z. physik. Chem., 130, 337 (1927).

<sup>14</sup> Ann. Chim. Phys., (4), 18, 255 (1869).

<sup>15</sup> Ber., 11, 1776 (1878).

is metastable, however, and is soon transformed to the heptahydrate. It is pale green in color. Crystals with faces of several mms. dimensions were obtained. Hensgen obtained it as green needles, by treating the heptahydrate with concentrated hydrochloric acid.

The pentahydrate,  $\text{FeSO}_4 \cdot 5\text{H}_2\text{O}$ , is said by Roscoe and Schorlemmer to form when a solution of ferrous sulphate in aqueous sulphuric acid is evaporated in vacuum, the heptahydrate first separating, then the pentahydrate, and finally the tetrahydrate, isomorphous with the corresponding manganese salt. It is probable that this sequence does not take place, as will be shown later in this paper. Lecoq de Boisbaudran<sup>1</sup> found that seeding with cupric sulphate pentahydrate will induce the separation of ferrous sulphate pentahydrate from an aqueous solution as a metastable form quickly transforming to the heptahydrate. He states that it is difficult to obtain and only from solutions much supersaturated with respect to the heptahydrate. It was not observed by Agde and Barkholt,<sup>2</sup> nor by Cameron and Crockford<sup>3</sup> and the evidence for the possible existence of this hydrate needs confirmation.

The tetrahydrate,  $\text{FeSO}_4 \cdot 4\text{H}_2\text{O}$ , was found by Fraenckel<sup>4</sup> to be the stable form in contact with its aqueous solutions between  $56.6^\circ\text{C}$  and  $64.4^\circ\text{C}$  and he describes it as bright green in color. It will be shown presently that it is stable in contact with a saturated aqueous solution to  $67.4^\circ\text{C}$  and that it is stable at  $65^\circ\text{C}$  in solutions containing as much as 2.5 percent sulphuric acid. The crystals obtained were quite small and faintly green. When dried, the crystals remained clear, apparently quite stable, and unaffected by exposure to the air for weeks.

The trihydrate,  $\text{FeSO}_4 \cdot 3\text{H}_2\text{O}$ , has been reported by Kane<sup>5</sup> and by Kühne.<sup>6</sup> Kane obtained it by crystallization from a solution saturated with hydrochloric acid, as bright-green, hard, transparent crystals, but could not determine their form. The water found on analysis agreed with that calculated for the trihydrate.

The dihydrate,  $\text{FeSO}_4 \cdot 2\text{H}_2\text{O}$ , has been reported by von Bonsdorff,<sup>7</sup> in a reference not accessible to the writer. As will be shown presently it is stable in contact with its saturated aqueous solution above  $67.4^\circ\text{C}$ . It is stable at  $65^\circ\text{C}$ , in contact with aqueous solutions containing more than about 2.5 percent sulphuric acid. It was obtained as a very finely divided white crystalline powder quite stable in the air when dry, dissolving at ordinary temperatures more slowly than the other hydrates obtained in this investigation. It packs on a filter to a dense mass, which may be washed only with difficulty.

The monohydrate,  $\text{FeSO}_4 \cdot \text{H}_2\text{O}$ , was found by Fraenckel to be the stable solid in contact with the saturated aqueous solutions above  $64.4^\circ\text{C}$ ; but

<sup>1</sup> Loc. cit. See also Marignac: *Ann. d. Mines*, (5), 9, 9 (1856); Lecoq de Boisbaudran, Liebig and Kopp: *Jahresber.*, 1867, 152.

<sup>2</sup> *Z. angew. Chem.*, 39, 851 (1926).

<sup>3</sup> *J. Phys. Chem.*, 33, 709 (1929).

<sup>4</sup> *Z. anorg. Chem.*, 55, 223 (1907).

<sup>5</sup> *Ann.*, 19, 7 (1836).

<sup>6</sup> *Schweigger's Journal*, 61, 235 (1831).

<sup>7</sup> *Bericht über d. Versammlung deutsch. Naturforscher und Ärzte in Prag, 1837*, 124.

he is mistaken, as will be shown presently. It will be shown also that it is the stable compound below this temperature in contact with solutions containing higher concentrations of sulphuric acid. It is a snow white, crystalline, fine powder. When dry it is stable in the air, without appreciable oxidation on long standing, or other obvious change.

The anhydrous salt,  $\text{FeSO}_4$ , is not stable in contact with aqueous solutions under any conditions, so far as now known. It is readily prepared by heating a hydrate in a neutral atmosphere, or better in hydrogen. But it is also decomposed rather readily on heating, the thermal decomposition having interested a number of investigators,<sup>1</sup> and recently Greulich,<sup>2</sup> who finds it decomposes according to the equation:  $2\text{FeSO}_4 = \text{Fe}_2\text{O}_3 + \text{SO}_3 + \text{SO}_2$ . At atmospheric pressure the dissociation temperature is probably  $680^\circ\text{C}$  and the heat of dissociation 189.5 calories.

*The Effect of Temperature.* For comparison the data of Etard,<sup>3</sup> Fraenckel,<sup>4</sup> Agde and Barkholt,<sup>5</sup> and the International Critical Tables,<sup>6</sup> have been recalculated to the basis of percent  $\text{FeSO}_4$  in solution. The data of Brandes and Firnhaber,<sup>7</sup> Tobler,<sup>8</sup> and Mulder,<sup>9</sup> are not included as being of historical interest only. The results are assembled in Table I.

Below  $60^\circ\text{C}$  the figures of Etard and Agde and Barkholt agree very well with the International Critical Table. Etard's figures for  $130^\circ\text{C}$  and  $152^\circ\text{C}$  lie fairly near to extrapolated values from the International Critical Table, but his figures below  $60^\circ\text{C}$  and for  $130^\circ\text{C}$  do not. In good agreement with the International Critical Table is Agde and Barkholt's figure at  $80^\circ\text{C}$ , and Schreinmakers<sup>10</sup> 24.89 percent at  $30^\circ\text{C}$ . Too high are Wirth's<sup>11</sup> figure of 22.8 percent at  $25^\circ\text{C}$ , Occleshaw's<sup>12</sup> 22.98 percent at  $25^\circ\text{C}$  and Schiff's<sup>13</sup> 37.2 percent at  $20^\circ\text{C}$ , while Hauer's<sup>14</sup> 17.02 percent at  $15^\circ\text{C}$  is too low. Fraenckel determined two transition temperatures approximately, but all his solubility data are too high.

It has been assumed hitherto that the stable solid in contact with its saturated solution in water, above  $64^\circ$ , is the monohydrate. It is so stated in the International Critical Tables. Fraenckel thought he had proved it. He used the van Bijlert<sup>15</sup> method with sodium chloride as "tell-tale" to

<sup>1</sup> Marchal: J. Chim. phys., 22, 325 (1925); Keppeler and D'Ans: Z. physik. Chem., 62, 89 (1908).

<sup>2</sup> Z. anorg. allgem. Chem., 168, 197 (1927).

<sup>3</sup> Ann. Chim. Phys., (7), 2, 553 (1894).

<sup>4</sup> Z. anorg. Chem., 55, 223 (1907).

<sup>5</sup> Z. angew. Chem., 39, 851 (1926).

<sup>6</sup> "International Critical Tables", 4, 224 (1928).

<sup>7</sup> Archiv. Apothekerverein in nördl. Deutschland, VII, 83.

<sup>8</sup> Ann., 95, 193 (1855).

<sup>9</sup> "Scheikundige Verhandelingen," III, 3, 141 (1864).

<sup>10</sup> Z. physik. Chem., 71, 110 (1910).

<sup>11</sup> Z. anorg. Chem., 79, 364 (1913).

<sup>12</sup> J. Chem. Soc., 127, 2598 (1925).

<sup>13</sup> Ann., 118, 362 (1861).

<sup>14</sup> J. prakt. Chem., 103, 114 (1868).

<sup>15</sup> Z. physik. Chem., 8, 343 (1891).

determine the composition of the solid phases at 50°, 64° and 80°C. At this last temperature he found FeO to be 42.55 per cent, calculated 42.30, corresponding to the monohydrate  $\text{FeSO}_4 \cdot \text{H}_2\text{O}$ . At all three temperatures he found good agreement with calculated figures in spite of the recognized difficulties and uncertainties of the analytical procedure. But the results to be detailed later on the solubility of ferrous sulphate in aqueous solutions of sulphuric acid have made necessary a re-examination of the solubility in water alone, the transition point where the tetrahydrate is in stable contact with a lower hydrate, and the composition of the lower hydrate.

To this end the heptahydrate was recrystallized from dilute alcohol, filtered from the mother liquor, washed with alcohol, then with ether, and dried by pressing between bibulous paper. This product was then added gradually to hot distilled water which had just been boiled vigorously for an hour, a current of hydrogen gas being bubbled continually through the mass, until there was, approximately, 50 grams of solid in contact with 100 ccs. of saturated solution. The containing bottle was tightly closed with a new rubber stopper, and alternately heated and cooled for 36 hours. No signs of oxidation appearing, it was placed in a thermostat at 75°C, being momentarily withdrawn from time to time for vigorous shaking. After being in the thermostat for 24 hours, it was seeded with about 5 gms. of monohydrate. After another 24 hours, a sample of the solid phase was freed from mother liquor by suction, washed with alcohol and ether, and dried by pressing between filter paper. Calculated from its iron content, it contained 3.8 moles water per mole ferrous sulphate. The mother liquor contained 35.03 per cent ferrous sulphate. The mass was then seeded with about 2 gms. of the dihydrate. After another 24 hours, 5.3808 gms. of the washed and dried solid phase contained 4.1744 gms.  $\text{FeSO}_4$ . It contained 2.4 mols water per mole ferrous sulphate and the mother liquor contained 32.97 per cent ferrous sulphate. After another 24 hour period, 5.6315 gms. of the solid contained 4.4386 gms.  $\text{FeSO}_4$ , and the water content was therefore 2.2 moles per mole  $\text{FeSO}_4$ , while the mother liquor contained 31.58 per cent  $\text{FeSO}_4$ . A day later the mother liquor contained 31.02 per cent  $\text{FeSO}_4$ , and two days later two separate samples of the mother liquor gave respectively 31.06 and 31.04 per cent  $\text{FeSO}_4$ .

It seems safe to conclude, therefore, that the stable solid phase at 75° in contact with a saturated water solution is the dihydrate and the solubility at this temperature is 31.04 gms.  $\text{FeSO}_4$  per 100 gms. solution.

A large sample, about 200 gms., of heptahydrate, crystallized from a dilute alcohol solution, washed with alcohol and ether, and dried between bibulous paper, was suspended in freshly boiled water to which a small amount of alcohol had been added. The containing flask was fitted with a reflux condenser and the mass boiled for about 5 hours at a temperature of 96° ±. The solid was then separated quickly from the mother liquor on a Buchner funnel, and, after washing with alcohol, then ether, and dried, 4.0725 gms. were found, through an iron determination, to contain 3.2761

gms.  $\text{FeSO}_4$ , corresponding to a water content of 2.05 moles per mole ferrous sulphate.

Fraenckel found the temperature for the transition heptahydrate to tetrahydrate, to be  $56.56^\circ\text{C}$  by a dilatometer. We have found it to be not higher than  $56.68^\circ\text{C}$  by a Bremer-Frowein differential tensimeter.<sup>1</sup> Fraenckel also found, with a dilatometer, a transition point at  $64.70^\circ\text{C}$ , and cites in support a "Knicke" in the solubility curve of Mulder at  $63.5^\circ$ , and one in the solubility curve of Etard at  $65^\circ$ , as well as the melting point of  $64^\circ$  for the heptahydrate as found by Tilden.

If the melting point of the heptahydrate be  $64^\circ\text{C}$  as found by Tilden, it cannot be the transition temperature for the tetrahydrate to the dihydrate or to the monohydrate as assumed by Fraenckel and the International Critical Tables.

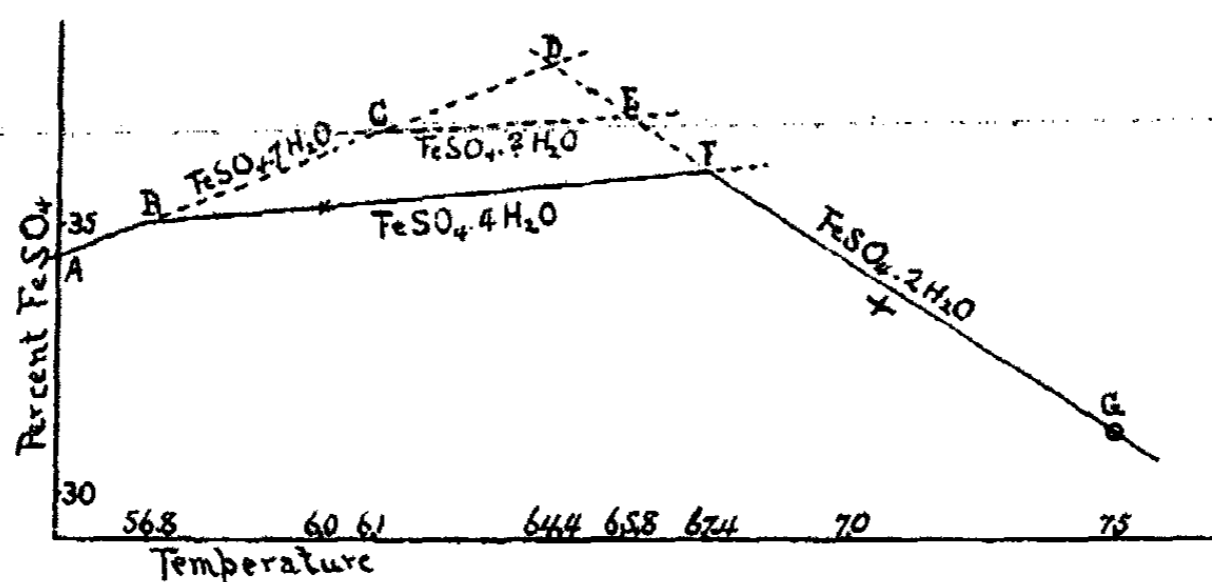

FIG. 1

Solubility of Ferrous Sulphate in Water, showing temperatures at Transition Points. Solid lines stable, broken lines metastable conditions.

A Bremer-Frowein tensimeter was arranged with heptahydrate in one arm and tetrahydrate, with a few drops of water, in the other. On raising the temperature a tenth of a degree about every 12 hours, equal vapor pressure in both arms was attained at about  $56.8^\circ\text{C}$ .

A second instrument was prepared with tetrahydrate in one arm and dihydrate in the other. A small addition of heptahydrate was made to each before evacuating and sealing. This instrument showed equal vapor tensions in both arms at about  $68^\circ$ .

Both instruments, after cooling, were very slowly heated in a large water bath, readings of the difference in level of the oil gauge and the temperature being made at 5 minute intervals. Similar readings were made with the temperature falling. The response in vapor pressure to change in temperature was fairly prompt although there was an appreciable lag. Five transition points or temperature at which the vapor pressures in the two arms closely approached equality, were discovered. The procedure was repeated a number of times, until the instruments indicated but two transitions, the one at

<sup>1</sup> Z. physik. Chem., 1, 5; 362 (1888); 7, 260 (1891); 17, 52 (1895).

about 57° and the other at about 68°. The average of the determinations, five sets on a rising thermometer with two sets on a falling thermometer, gave transitions at about 57°, 61°, 64.4°, 65.8° and 67.8°. Of these the one at 64.4° seemed to be the most sharply and clearly determined, the one at 65.8° the least. These data seem to be most reasonably interpreted as in Fig. 1.

TABLE I  
Comparison of Data. The Effect of Temperature on the Solubility of Ferrous Sulphate, FeSO<sub>4</sub>, in Water. Stated in Percentages of Saturated Solution.

T.	Etard	Fraenckel	Agde and Barkholt	International Critical Tables	Solid Phase
-10°	13.0				?
-1.82°		14.98			FeSO <sub>4</sub> ·7H <sub>2</sub> O
0°		15.62		13.58	"
1°			13.79		"
5°	15.1				"
9.6°			17.10		"
10.0		20.85		17.02	"
20.0		26.42		20.90	"
21.			21.30		"
24.	22.7				"
25.			22.98		"
30.		33.0		24.70	"
34.	26.3		26.56		"
40.				28.70	"
43.			30.04		"
50.				32.50	"
54.			34.50		"
56.6		54.58			FeSO <sub>4</sub> ·7H <sub>2</sub> O
60.	36.4	55.02		35.48	FeSO <sub>4</sub> ·4H <sub>2</sub> O
64.				35.73	
67.	37.7				
70.				33.79	FeSO <sub>4</sub> ·2H <sub>2</sub> O
77.	37.8				
80.		43.0	30.20	30.43	FeSO <sub>4</sub> ·2H <sub>2</sub> O
86.	37.8				"
90.				27.20	"
94.	36.7				"
102.	34.7				"
112.	28.0				"
130.	17.3				"
152.	2.5				"

The line AB is a part of the solubility curve of the heptahydrate based on the figures in the International Critical Tables. It is continued to D since all investigators agree that there is a transition at  $64.4^{\circ}\text{C}$ . Assuming the real existence of this point and the correctness of my solubility determination at  $75^{\circ}\text{C}$  (circle) at G, the line DEFG is drawn. Assuming the correctness of the International Critical Table's solubility at  $60^{\circ}$  and a transition at  $56.8^{\circ}\text{C}$ , the line BF is drawn, showing a transition at  $67.4^{\circ}\text{C}$  instead of  $67.8^{\circ}$  as found in the tensimeter measurements. The line CE is the solubility curve of a hydrate of undetermined composition metastable over the range of temperature indicated.

I am indebted to Mr. A. E. Hughes for the tensimeter readings and to Mr. R. H. Munch for constructing the apparatus; and more particularly for building and maintaining the thermostats necessary for the experiments to be described presently.

*The effect of other electrolytes on the solubility of ferrous sulphate in water is generally quite marked. Electrolytes without a common ion increase the solubility; but qualitative data only are available. Systems containing another sulphate as well as ferrous sulphate and water are often mentioned in the literature. For instance,  $\text{FeSO}_4 \cdot 7\text{H}_2\text{O}$ , is isomorphous with  $\text{CoSO}_4 \cdot 7\text{H}_2\text{O}$ ,  $\text{MgSO}_4 \cdot 7\text{H}_2\text{O}$ , etc.  $\text{FeSO}_4 \cdot (\text{NH}_4)_2\text{SO}_4$  is isomorphous with  $\text{ZnSO}_4 \cdot (\text{NH}_4)_2\text{SO}_4$ . Many similar cases are cited; but the attention generally, has been concentrated upon the solid phases, with scanty or no data of value upon the accompanying liquid phases. In the following paragraphs are summarized the principal studies pertinent to this investigation.*

*The System: Ferrous Sulphate-Sodium Sulphate-Water* has been studied by Koppel.<sup>1</sup> The cryohydrate temperature for ferrous sulphate and water is  $-2^{\circ}\text{C}$ , while that for ferrous sulphate, sodium sulphate decahydrate, and water is  $-3^{\circ}\text{C}$ . With both salts present as solid phases, the solubility of each seems to be slightly greater than when present by itself up to  $18.5$ - $18.8^{\circ}\text{C}$ . At this temperature a double salt,  $\text{FeSO}_4 \cdot \text{Na}_2\text{SO}_4 \cdot 4\text{H}_2\text{O}$ , becomes a stable solid phase. The liquid phase at this point contains 18.3 per cent  $\text{FeSO}_4$  and 13.8 per cent sodium sulphate. Continued addition of ferrous sulphate heptahydrate with rise of temperature is accompanied by an increase in concentration of ferrous sulphate on a smooth curve from the cryohydrate point to  $40^{\circ}\text{C}$ . But the solubility of the sodium sulphate decreases, the concentration falling on a straight line.

When sodium sulphate decahydrate is added in excess, the solubility of the sodium sulphate increases with rising temperature, and the ferrous sulphate decreases, until  $31.4^{\circ}\text{C}$  is reached, when the two stable solids are the double salt and the anhydrous sodium sulphate. Curiously, further rise in temperature produces no change in composition of the liquid phase. Also, there is no change in composition of the liquid phase in contact with the double salt alone from  $20.5^{\circ}\text{C}$  (below which the latter is not stable by itself) up to  $40^{\circ}\text{C}$ .

<sup>1</sup> Z. physik. Chem., 52, 405 (1905).



The double salt can be prepared by melting together the components, but better by bringing them together in solution and adding an excess of sulphuric acid. Washed with alcohol and ether and dried, the white double salt is quite stable in the air. The publication does not give data from which isotherms can be plotted.

*The System: Ferrous Sulphate-Lithium Sulphate-Water*, at 30°C, has been studied by Schreinemakers with Reindler.<sup>1</sup> The two salts mutually depress one another's solubility in water. There is a transition point with a liquid phase containing about 16.1 per cent ferrous sulphate (FeSO<sub>4</sub>) and 16.5 per cent lithium sulphate, Li<sub>2</sub>SO<sub>4</sub>. Solutions richer in ferrous sulphate are in contact with ferrous sulphate heptahydrate, FeSO<sub>4</sub>·7H<sub>2</sub>O, as stable solid phase. Solutions richer in lithium sulphate are in contact with lithium sulphate monohydrate, Li<sub>2</sub>SO<sub>4</sub>·H<sub>2</sub>O, as the stable solid.

*The System: Ferrous Sulphate-Ammonium Sulphate-Water*, at 30°C, has been studied by Schreinemakers with van Meurs.<sup>2</sup> The two salts mutually depress each other's solubility in water. The double salt, FeSO<sub>4</sub>(NH<sub>4</sub>)<sub>2</sub>SO<sub>4</sub>·6H<sub>2</sub>O, is the stable solid phase in contact with solutions between the limits 0.79 per cent FeSO<sub>4</sub> — 43.88 per cent (NH<sub>4</sub>)<sub>2</sub>SO<sub>4</sub> and 25.24 per cent FeSO<sub>4</sub> — 5.91 per cent (NH<sub>4</sub>)<sub>2</sub>SO<sub>4</sub>. Solutions richer in ferrous sulphate are in contact with ferrous sulphate heptahydrate, FeSO<sub>4</sub>·7H<sub>2</sub>O. Those richer in ammonium sulphate are in contact with the anhydrous salt, (NH<sub>4</sub>)<sub>2</sub>SO<sub>4</sub>, as stable solid phase.

*The Quaternary System: Ferrous Sulphate-Lithium Sulphate-Ammonium Sulphate-Water*, at 30°C, was also studied by Schreinemakers, and found to have three "constant solutions" in contact with three solid phases. The composition of the solutions and the formulas of the accompanying solid phases at the several transition points are assembled in Table II.

TABLE II

Percentage Composition of Liquid Phases and Formulas of Accompanying Solids in the System, FeSO<sub>4</sub>—Li<sub>2</sub>SO<sub>4</sub>—(NH<sub>4</sub>)<sub>2</sub>SO<sub>4</sub>—H<sub>2</sub>O at 30°C

FeSO <sub>4</sub> percent	Li <sub>2</sub> SO <sub>4</sub> percent	(NH <sub>4</sub> ) <sub>2</sub> SO <sub>4</sub> percent	Solid Phases
16.1	16.5	0.	FeSO <sub>4</sub> ·7H <sub>2</sub> O—Li <sub>2</sub> SO <sub>4</sub> ·H <sub>2</sub> O
16.85	15.62	4.82	FeSO <sub>4</sub> ·7H <sub>2</sub> O—Li <sub>2</sub> SO <sub>4</sub> ·H <sub>2</sub> O—FeSO <sub>4</sub> (NH <sub>4</sub> ) <sub>2</sub> SO <sub>4</sub> ·6H <sub>2</sub> O
25.22	0.00	5.93	FeSO <sub>4</sub> ·7H <sub>2</sub> O—FeSO <sub>4</sub> (NH <sub>4</sub> ) <sub>2</sub> SO <sub>4</sub> ·6H <sub>2</sub> O
.79	0.00	43.86	FeSO <sub>4</sub> (NH <sub>4</sub> ) <sub>2</sub> SO <sub>4</sub> ·6H <sub>2</sub> O—(NH <sub>4</sub> ) <sub>2</sub> SO <sub>4</sub>
.61	6.23	40.48	FeSO <sub>4</sub> (NH <sub>4</sub> ) <sub>2</sub> SO <sub>4</sub> ·6H <sub>2</sub> O—(NH <sub>4</sub> ) <sub>2</sub> SO <sub>4</sub> —(NH <sub>4</sub> ) <sub>2</sub> SO <sub>4</sub> ·Li <sub>2</sub> SO <sub>4</sub>
0.00	6.59	39.55	(NH <sub>4</sub> ) <sub>2</sub> SO <sub>4</sub> —(NH <sub>4</sub> ) <sub>2</sub> SO <sub>4</sub> ·Li <sub>2</sub> SO <sub>4</sub>
4.15	20.03	12.32	FeSO <sub>4</sub> (NH <sub>4</sub> ) <sub>2</sub> SO <sub>4</sub> ·6H <sub>2</sub> O—(NH <sub>4</sub> ) <sub>2</sub> SO <sub>4</sub> ·Li <sub>2</sub> SO <sub>4</sub> —Li <sub>2</sub> SO <sub>4</sub> —Li <sub>2</sub> SO <sub>4</sub> ·H <sub>2</sub> O

<sup>1</sup>Z. physik. Chem., 71, 110 (1910).

<sup>2</sup>Z. physik. Chem., 71, 111 (1910).

*The System: Ferrous Sulphate-Magnesium Sulphate-Water* has been studied by Rammelsberg,<sup>1</sup> Retgers,<sup>2</sup> and Barker<sup>3</sup>; but quantitative data for the liquid phase are yet lacking. The two salts mutually depress one another's solubility. Two series of solid solutions, or mixed crystals are found. In one, containing from zero to 57 per cent  $\text{MgSO}_4 \cdot 7\text{H}_2\text{O}$ , the crystals are monoclinic. In the other, containing from 75 to 100 per cent  $\text{MgSO}_4 \cdot 7\text{H}_2\text{O}$ , the crystals are rhombic. Retgers worked mainly at 20°-23°C. He determined the specific gravities, from which he computed the molecular volumes, the purpose of the investigation being to obtain an insight into the factors involved in isomorphism.

*The System: Ferrous Sulphate-Aluminum Sulphate-Water*, at 25°C, has been studied by Occleshaw.<sup>4</sup> The two salts mutually depress each other's solubility. There are three solubility curves. Hydrated aluminum sulphate,  $\text{Al}_2(\text{SO}_4)_3 \cdot 18\text{H}_2\text{O}$ , is the stable solid phase in contact with solutions containing less than 4.13 per cent ferrous sulphate,  $\text{FeSO}_4$ . At this point the solution contains 25.4 per cent aluminum sulphate,  $\text{Al}_2(\text{SO}_4)_3$ . From this point, until a liquid phase is reached containing 10.17 per cent  $\text{FeSO}_4$  and 20.16 per cent  $\text{Al}_2(\text{SO}_4)_3$ , the stable solid in contact with the solutions is a double salt of the composition,  $\text{FeSO}_4 \cdot \text{Al}_2(\text{SO}_4)_3 \cdot 24\text{H}_2\text{O}$ , corresponding to the alums. With higher concentrations of ferrous sulphate the solutions are in contact with ferrous sulphate heptahydrate,  $\text{FeSO}_4 \cdot 7\text{H}_2\text{O}$ , as the stable solid. Occleshaw determined the solid phase by analyzing residues in contact with the several liquid phases and plotting the results on the triangular diagram by the Schreinemakers-Bancroft method. There is a congruent point on the curve corresponding to the double salt. This was confirmed experimentally by crystallizing the double salt from a solution containing ferrous sulphate and aluminum sulphate in equimolecular proportions. The salt so obtained consisted of white needles which matted on the filter to an asbestos-like mass.

*The System: Ferrous Sulphate, Thallous Sulphate, and Water.* Benrath<sup>5</sup> finds that a yellowish-green, soluble salt is formed as a crystalline turbid mass if at least five times excess of ferrous sulphate be added to a saturated solution of thallous sulphate. The salt has the composition  $\text{FeSO}_4 \cdot 11\text{SO}_4 \cdot 6\text{H}_2\text{O}$  and has been noted previously by Werther.<sup>6</sup> Benrath does not furnish figures, but a diagram of the system, from which the data for the transition point can be read approximately.

*The System: Ferrous Sulphate, Cupric Sulphate, and Water.* Agde and Barkholt<sup>7</sup> made a large number of cooling curves from which they have plotted the isotherms for 10°, 25°, 30°, 40°, and 56°C.

<sup>1</sup> "Krystallographische Chemie", 1, 434.

<sup>2</sup> Z. physik. Chem., 3, 534 (1889).

<sup>3</sup> J. Soc. Chem. Ind., 44, 20 (1925).

<sup>4</sup> J. Chem. Soc., 127, 2598 (1925).

<sup>5</sup> Z. anorg. allgem. Chem., 151, 23 (1926).

<sup>6</sup> J. prakt. Chem., 92, 134 (1864).

<sup>7</sup> Z. angew. Chem., 39, 851 (1926).

Hydrolysis of the salts was found not to be important. At lower concentrations of the liquid phase with respect to ferrous sulphate, the solutions are in contact with cupric sulphate pentahydrate,  $\text{CuSO}_4 \cdot 5\text{H}_2\text{O}$ , as stable solid phase. The solubility of the cupric sulphate is, practically, not changed by increasing concentration of ferrous sulphate until a transition point is reached. Beyond the transition point the two salts markedly decrease each others solubility and the solid phases in contact with these solutions are members of a series of solid solutions or isomorphous mixtures of  $\text{FeSO}_4 \cdot 7\text{H}_2\text{O}$  and  $\text{CuSO}_4 \cdot 7\text{H}_2\text{O}$  previously described by Retgers.<sup>1</sup> The limiting member of this series of solid solutions, at the transition point, probably has the composition,  $2\text{FeSO}_4 \cdot 7\text{H}_2\text{O} \cdot 3\text{CuSO}_4 \cdot 7\text{H}_2\text{O}$ . Retgers described two series of mixed crystals of the heptahydrates of cupric sulphate and ferrous sulphate; a monoclinic series, ferrous sulphate heptahydrate varying from 47 to 100 per cent; and a triclinic series, ferrous sulphate heptahydrate varying from zero to 5 per cent. The monoclinic double salt,  $2\text{FeSO}_4 \cdot 7\text{H}_2\text{O} \cdot 3\text{CuSO}_4 \cdot 7\text{H}_2\text{O}$ , described by Pisani<sup>2</sup> as a natural mineral occurring in rather large masses as stalactites in a Turkish mine, was not observed. Agde and Barkholt suggest that it is metastable only and changes to the triclinic limiting member of the series of solid solutions.

Agde and Barkholt's results are remarkably consistent and it would appear to be easy to duplicate them. Cameron and Crockford,<sup>3</sup> made a series of solubility determinations at 30°C which confirmed the general nature and slopes of the Agde and Barkholt isotherms, but the location of the transition point is not consistent with the several location found by Agde and Barkholt. Agde and Barkholt found equilibrium to be reached easily and quickly while Cameron and Crockford had exactly opposite experiences. The composition of the solutions at the transition point are assembled in Table III.

TABLE III

Composition of Aqueous Solutions of Cupric Sulphate and Ferrous Sulphate at the Transition Point,  $\text{CuSO}_4 \cdot 5\text{H}_2\text{O} - (\text{Cu}, \text{Fe})\text{SO}_4 \cdot 7\text{H}_2\text{O}$ . Calculated from the Results of Agde and Barkholt.

Temp.	$\text{CuSO}_4$ percent	$\text{FeSO}_4$ percent
10.°C	14.34	5.57
25°	17.70	8.82
40°	21.57	12.12
56°	25.34	15.64

From Cameron and Crockford's figures the composition of the solution at the transition point at 30°C is, approximately 15 per cent  $\text{CuSO}_4$  and 12.6 per cent  $\text{FeSO}_4$ .

<sup>1</sup> Z. physik. Chem., 15, 555 (1894).

<sup>2</sup> Compt. rend., 48, 807 (1859).

<sup>3</sup> J. Phys. Chem., 33, 709 (1929).

*The Quaternary System: Ferrous Sulphate, Cupric Sulphate, Sulphuric Acid, and Water at 30°C.* Cameron and Crockford<sup>1</sup> have charted two isotherms for the system finding that not only do the two salts depress each other's solubility, but that the presence of sulphuric acid increases the depression in every case. No transition points were found on either isotherm. The nature of the solid phases was the particular object of the investigation. These were found to be, probably, in every case, cupric sulphate pentahydrate,  $\text{CuSO}_4 \cdot 5\text{H}_2\text{O}$  and a series of solid solutions each member of which contained ferrous sulphate, sulphuric acid, and water.

*The System: Ferrous Sulphate, Sulphuric Acid, and Water.* Kenrick<sup>2</sup> cites Dammer<sup>3</sup> for references to the older literature describing a number of hydrates of ferrous sulphate and double ferrous hydrogen sulphates, some of doubtful validity. Kenrick found that, at room temperature, ferrous sulphate heptahydrate,  $\text{FeSO}_4 \cdot 7\text{H}_2\text{O}$ , is the stable solid phase in contact with solutions up to 43.9 percent sulphuric acid. In the present investigation at

TABLE IV

Series No.	Solution		Residue		Solid Phase
	$\text{H}_2\text{SO}_4$ per cent	$\text{FeSO}_4$ per cent	$\text{H}_2\text{SO}_4$ per cent	$\text{FeSO}_4$ per cent	
	Solubility at 0°C				
1	1.81	14.1	3.23	28.91	$\text{FeSO}_4 \cdot 7\text{H}_2\text{O}$
2	4.10	13.18			"
3	8.45	11.10			"
4	15.56	8.93	10.67	27.01	"
5	17.76	7.67			"
6	25.98	4.80			"
7	26.84	4.57			"
8	32.50	3.99			"
9	34.48	3.67			"
10	36.05	3.64	16.24	33.10	"
11	36.33	3.68			"
12	37.79	3.46			"
13	38.62	3.38			$\text{FeSO}_4 \cdot 7\text{H}_2\text{O}$ + $\text{FeSO}_4 \cdot \text{H}_2\text{O}$ $\text{FeSO}_4 \cdot \text{H}_2\text{O}$
14	41.80	2.34			"
15	47.82	.91			"
16	53.25	.55			"
17	56.76	.46	25.42	49.50	"
18	60.21	.37			"
19	63.60	.28	25.62	40.00	"

<sup>1</sup> J. Phys. Chem., 33, 709 (1929).

<sup>2</sup> J. Phys. Chem., 12, 693 (1908).

<sup>3</sup> "Handbuch anorg. Chemie", 3, 329-337 (1893).

TABLE IV (Continued)

Series No.	H <sub>2</sub> SO <sub>4</sub>	Solution FeSO <sub>4</sub>	Residue		Solid Phase
			H <sub>2</sub> SO <sub>4</sub>	FeSO <sub>4</sub>	
Solubility at 25°C					
1	1.13	22.88			FeSO <sub>4</sub> ·7H <sub>2</sub> O
2	3.41	20.64	1.01	33.41	"
3	6.32	18.67			"
4	9.37	16.79			"
5	13.00	15.56	7.42	32.51	"
6	14.68	14.34			"
7	17.34	13.25			"
8	24.54	11.23			"
9	26.17	11.05	12.50	34.61	"
10	27.78	10.70			FeSO <sub>4</sub> ·7H <sub>2</sub> O + FeSO <sub>4</sub> ·H <sub>2</sub> O
11	31.00	8.50			FeSO <sub>4</sub> ·H <sub>2</sub> O
12	34.52	6.26			"
13	35.66	5.89	17.01	48.61	"
14	36.17	4.99			"
15	41.47	3.07			"
16	45.70	1.75	18.12	56.21	"
17	54.71	.97			"
18	57.15	.76			"
19	60.23	.56			"
20	61.92	.55	29.52	46.98	"
21	64.35	.40			"
Solubility at 55°C					
1	1.74	33.48			FeSO <sub>4</sub> ·7H <sub>2</sub> O
2	2.42	32.76			"
3	3.87	31.91			"
4	5.93	29.20	3.04	47.95	FeSO <sub>4</sub> ·H <sub>2</sub> O
5	6.45	28.62			"
6	7.73	26.87			"
7	11.44	24.34			"
8	15.43	20.45			"
9	22.26	15.42			"
10	31.30	9.25	26.00	22.1	"
11	38.31	5.39			"
12	45.37	3.03			"
13	51.02	1.64			"
14	56.49	1.01			"
15	64.03	.86			"
16	68.12	.76			"
17	69.20	.61	53.29	22.90	"

TABLE IV (Continued)

Series No.	Solution		Residue		Solid Phase
	H <sub>2</sub> SO <sub>4</sub>	FeSO <sub>4</sub>	H <sub>2</sub> SO <sub>4</sub>	FeSO <sub>4</sub>	
Solubility at 65°C					
1	1.82	34.24			FeSO <sub>4</sub> ·4H <sub>2</sub> O
2	1.61	34.66			"
3	3.29	32.57			FeSO <sub>4</sub> ·2H <sub>2</sub> O
4	10.21	25.11			"
5	16.32	20.48			"
6	29.46	10.38			"
Solubility at 75°C					
1	0.43	31.46			FeSO <sub>4</sub> ·2H <sub>2</sub> O
2	3.45	28.00			"
3	5.60	25.58			"
4	8.71	22.60			"
5	10.78	21.29			"
6	21.90	14.40			"
7	27.72	11.26			"
8	34.72	7.05			"

25°C the limit has been found to be 45.6 percent. Kenrick found ferrous sulphate tetrahydrate to be metastable below, but near this concentration, which has been confirmed by several observations in the present study. From 43.9 percent to 82.2 percent sulphuric acid, the stable solid in contact with the solutions is the monohydrate, FeSO<sub>4</sub>·H<sub>2</sub>O, white granular crystals. From 82.2 to 87.7 percent sulphuric acid in solution the stable solid is white, small, thin hexagons, with the composition, 2FeSO<sub>4</sub>·H<sub>2</sub>SO<sub>4</sub>. The compound FeSO<sub>4</sub>·H<sub>2</sub>SO<sub>4</sub> in irregular groups of fine crystals was found to be stable in contact with solutions of 87.7 to 94.1 percent sulphuric acid, and the compound FeSO<sub>4</sub>·3H<sub>2</sub>SO<sub>4</sub> in fine needles was stable in more concentrated solutions of sulphuric acid.

Wirth<sup>1</sup> quotes Scharitzer<sup>2</sup> as having noted that the presence of sufficient sulphuric acid induces a transformation of the heptahydrate to the monohydrate of ferrous sulphate. Wirth determined the 25°C isotherm for the system finding the transition point at about a 40 percent or a 12.2 normal solution of sulphuric acid. His data are in terms of grams ferrous sulphate dissolved by various volumes of aqueous sulphuric acid of stated normalities. Although a direct comparison is not possible, qualitatively, Wirth's results are confirmed by those to be given presently. Cameron and Crockford<sup>3</sup> have reported a few figures, which can now be regarded as of qualitative significance only. The system has been investigated by Moser and Hertzner,<sup>4</sup> who found the various ratios of ferrous sulphate and sulphuric acid which dissolves a definite amount of nitric oxide, or of sulphur dioxide.

<sup>1</sup>Z. anorg. Chem., 79, 364 (1913).

<sup>2</sup>Z. Min. Krist., 30, 209 (1899); 37, 549 (1903).

<sup>3</sup>J. Phys. Chem., 33, 709 (1929).

<sup>4</sup>Z. anal. Chem., 64, 81 (1924).

Solubility curves have been determined at 0°C and 25°C by Ethel Ruth Ward.<sup>1</sup> Eight-ounce nursing bottles were employed as containers each solution being about 150 cc in volume in contact with a solid phase of 30 to 50 grams. So large a mass, especially of solid, made the approach to final equilibrium rather slow. But, equilibrium once attained, it was less likely to be disturbed by extraneous influences and it was an advantage to be able to command a large volume of clear solution from which to draw samples without the intervention of filters. Usually, but not always, the sample was of about ten cc. volume and was quickly transferred by an ordinary pipette to a glass-stoppered weighing bottle. The samples were made up to 500 cc. volumes and suitable aliquots taken for analysis. Since the iron must be first removed before the sulphate determination, iron was determined gravimetrically as ferric oxide. To prevent occlusion or adsorption of sulphates, the ferric hydrate was always dissolved with hydrochloric acid and reprecipitated. Although somewhat more labor was involved, this procedure appeared preferable to the usual volumetric estimation with standard potassium permanganate solution particularly as a rather wide range of concentrations was involved in each series. Sulphates were determined as the barium salt, with the usual precautions. The precipitations were made from a relatively large volume to avoid as far as possible adsorption of excess barium.

The criteria that equilibria had finally been attained were that successive analyses of the contents at intervals of a week or more, should give prac-

TABLE V

Moles Water of Crystallization found in Solid Phase in Contact with Aqueous Solutions of Ferrous Sulphate and Sulphuric Acid

Series No.	0°	25°	55°	65°	75°
1	7.03	7.03	6.96	4.25	1.73
2		6.99	7.03	4.50	2.04
3			6.82	2.04	2.02
4	6.99			2.00	2.00
5		6.68		2.01	2.16
6				2.16	2.80
7					2.08
8	7.00				1.40
10	6.99				
14	1.22	.98			
16		1.02			
17	1.17	.94			
18		1.61			
19	1.12				
20		.67			

<sup>1</sup> Master's Thesis, University of North Carolina, (1929).

tically identical results, and that these results should, when plotted, fall on smooth curves. The approach to equilibria was very irregular with the individual cases; and, apparently false equilibrium is a common phenomenon with this system. The solutions were generally "seeded" with both the heptahydrate and the monohydrate during the approach to the final state.

Composition of the solid phases was established in two ways. In some cases residues of the solid and adhering mother liquor were analyzed, the data being given in Table IV. The composition of the solid was then found by plotting on the equilateral triangle by the method of Schreinemakers-Bancroft, or on the isosceles triangle, or by algebraical computations. In other cases, the solid was quickly drained of the mother liquor, washed successively with 98 percent alcohol, then with ether, and dried by pressing between bibulous paper. The results obtained by this procedure are assembled in Table V.

At zero degree, there is a transition point, with a "constant solution" containing 38.62 percent  $H_2SO_4$  and 3.38 percent  $FeSO_4$ . Extrapolation gives a value of about 15.3 percent  $FeSO_4$  in water alone, a figure somewhat low in comparison with Fraenckel's results but about 12 percent too high in comparison with the data of the International Critical Tables. It would appear that the results here given for  $0^\circ C$  may be somewhat high up to about 25 percent sulphuric acid. The number and character of the determinations in the vicinity of the transition point leave little doubt that they are substantially correct. In contact with solutions of less sulphuric acid content than that of the transition point, ferrous sulphate heptahydrate is the solid phase. With more concentrated solutions of sulphuric acid, ferrous sulphate monohydrate is the stable solid.

At  $25^\circ C$  the composition of the solution at the transition point is 27.78 percent  $H_2SO_4$  and 10.70 percent  $FeSO_4$ . Extrapolation shows approximately 24 percent  $FeSO_4$  in water alone, in good agreement with the data of the International Critical Tables. The stable solid phases are, again, the heptahydrate and monohydrate of ferrous sulphate.

The writer determined the solubilities at  $55^\circ$  and  $65^\circ C$ . At  $55^\circ C$ , efforts to realize the solution at the transition point failed. It is certainly near to solution No. 3. Plotting the results obtained on a large scale and interpolating, the figures 4 percent  $H_2SO_4$  and 31.6 percent  $FeSO_4$  are obtained. Extrapolation gives 34.9 percent  $FeSO_4$  as the solubility in water alone, in good agreement with the International Critical Tables. The solid phases are the heptahydrate and the monohydrate.

At  $65^\circ C$  two curves were realized. The stable solid phase in contact with the more dilute solutions of sulphuric acid was the tetrahydrate, while that in contact with the more concentrated solutions of acid was the dihydrate. By interpolation the concentrations at the transition point were found to be 2.5 percent  $H_2SO_4$  and 33.8 percent  $FeSO_4$ .

The results obtained at this temperature were unexpected as it was anticipated that but one curve would be obtained and but one solid phase, the monohydrate. All the solutions had been seeded, generously, with mono-



hydrate as well as heptahydrate, and there could be no doubt as to the stability of the solid phases as found. The thermometer was then checked. It registered  $+0.03$  on standing in a mush of ice and water,  $99.9^\circ$  in steam with a barometer reading of  $759.35$  mm Hg and  $32.43^\circ$  in melting sodium sulphate decahydrate.

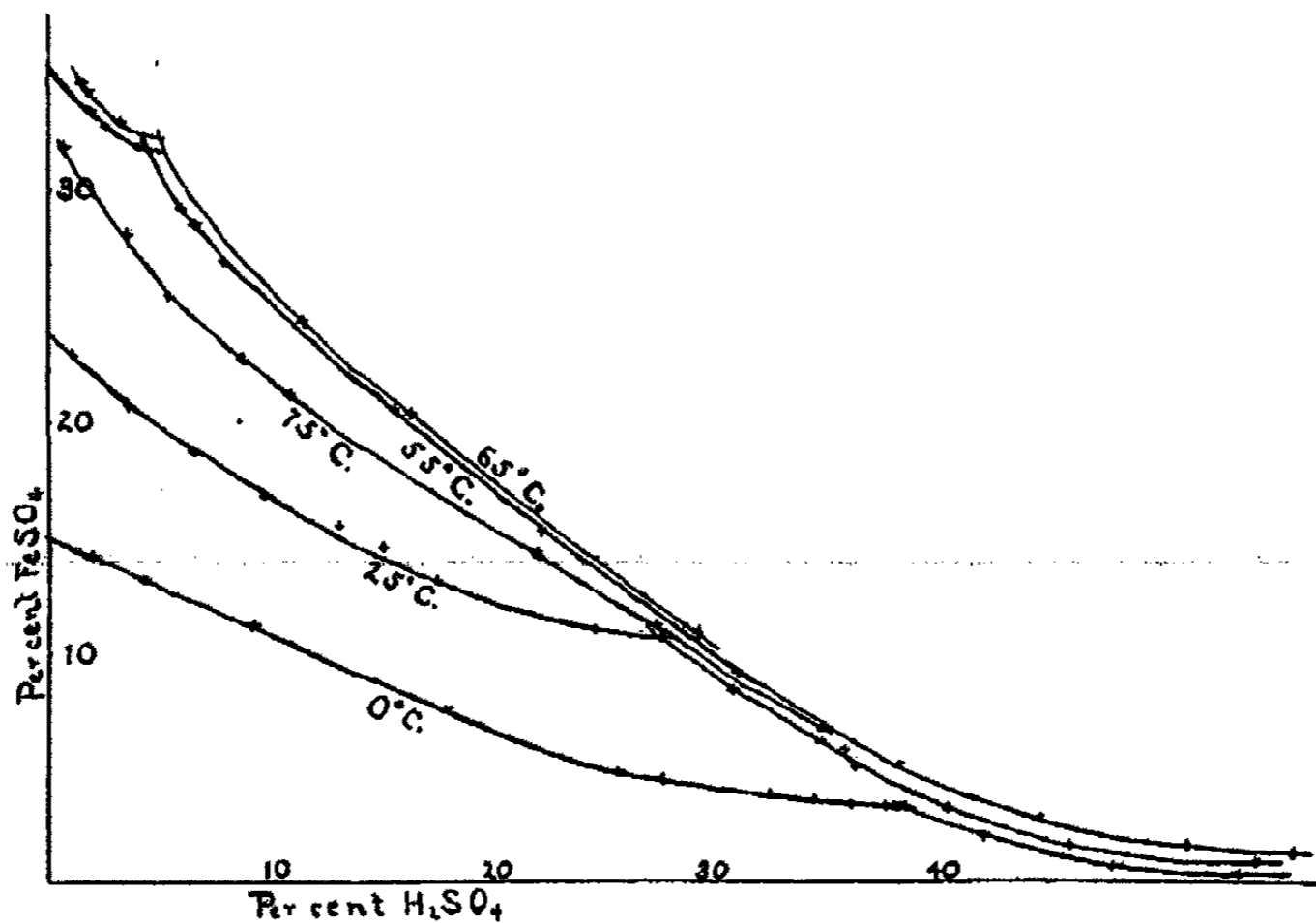

FIG. 2  
Solubility of Ferrous Sulphate in Aqueous Solutions of Sulphuric Acid.

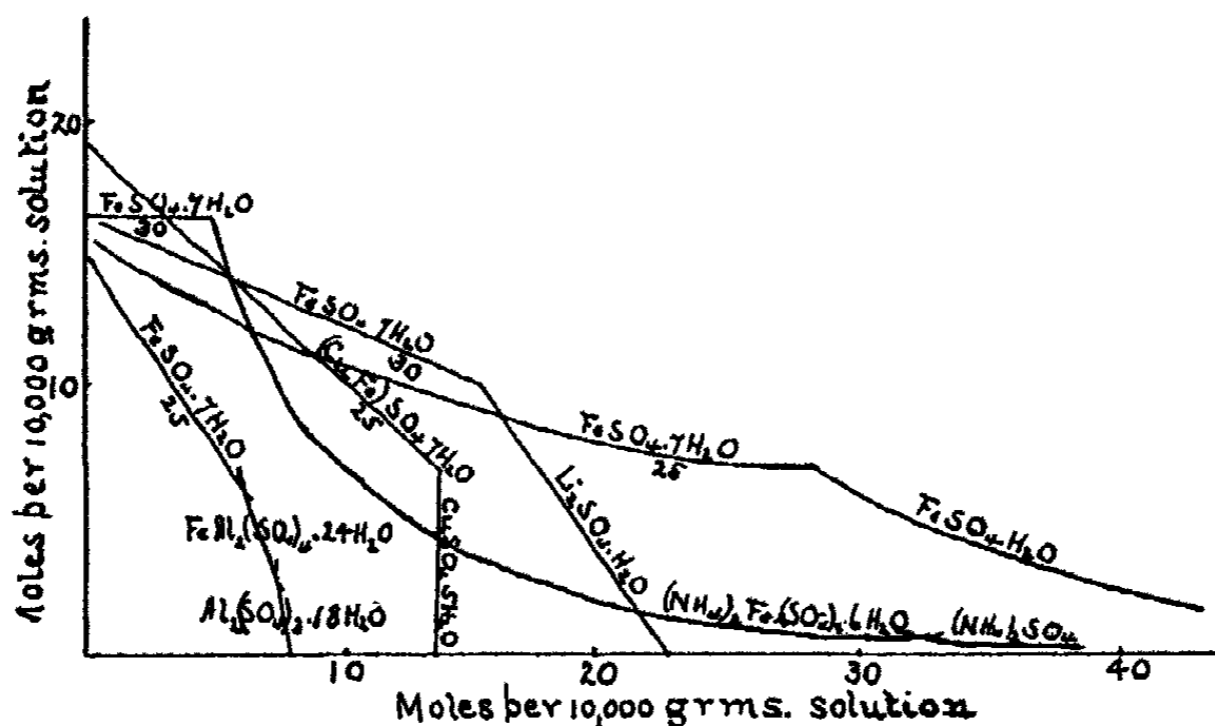

FIG. 3  
Solubility of Ferrous Sulphate in Aqueous Solutions of Other Sulphates.

I am indebted to Mr. A. T. Clifford for a series run at  $75^\circ$  C. The stable solid phase in contact with solutions from less than a half percent to nearly 35 percent sulphuric acid was found to be the dihydrate. It became necessary then to reinvestigate the solubility in water alone as described under the

heading Effect of Temperature. There can be no doubt that the stable solid at 75°C is the dihydrate throughout the whole range of acid solutions from zero to 35 percent. It would appear, however, that Mr. Clifford's determinations of  $\text{FeSO}_4$  at the lower concentrations of  $\text{H}_2\text{SO}_4$  may be slightly high.

*Comparison of the Effects of Other Sulphates on the Solubility of Ferrous Sulphate* has been attempted by computing the available data on a common basis of moles per 1000 grams of solution and charting the results. Some of the results are shown in Fig. 3. It would be needlessly confusing to include all. Temperatures and solid phases are indicated. Beyond the general conclusion that all other sulphates depress the solubility of ferrous sulphate, this method of attack does not appear helpful.

#### Summary

1. Ferrous sulphate is insoluble or very slightly soluble in solvents other than water.
2. The general properties of aqueous solutions of ferrous sulphate have been examined.
3. The conditions necessary to the existence of the several hydrates of ferrous sulphate have been examined.
4. The data regarding the effect of temperature on the solubility of ferrous sulphate in water have been compared. Corrections have been made and new data added.
5. The effects of other sulphates on the solubility of ferrous sulphate have been compared.
6. The solubilities of ferrous sulphate in aqueous solutions of sulphuric acid have been found at 0°, 25°, 55°, 65°, and 75°C. The composition of the solid phases in contact with the liquid solutions, and the composition of the solutions at the transition points have been determined.

*University of North Carolina,  
Chapel Hill,  
North Carolina.*

## SLOW AND INDUCED OXIDATION OF GLYCOGEN, LECITHIN, CHOLESTEROL, FORMATE, OLEATE, STEARATE, AND SOME FOOD MATERIALS

BY C. C. PALIT AND N. R. DHAR

In previous publications<sup>1</sup> we have shown that carbohydrates, fats, and nitrogenous substances, occurring either singly or in mixtures, can be oxidised at the ordinary temperature by passing air in presence of reducing agents and some metallic hydroxides. We have also shown that the amount of oxidation of carbohydrates is greatly decreased by the presence of fats.

TABLE I

### *Oxidation of glycogen in presence of different inductors*

Estimation of glycogen in presence of (i) freshly precipitated hydroxides of different metals in neutral solutions and (ii) caustic soda, sodium bicarbonate and sodium sulphite. The volume of glycogen used was 10 c.c. and the volumes of different salt solutions, each of 1% concentration, were 20 c.c. in each case. The hydroxides were precipitated from the salt solutions by the addition of an equivalent amount of caustic soda. The volume of air passed was 36.5 litres in 5½ hours (10 c.c. of glycogen  $\equiv$  0.2343 gm. of CuO = 0.1065 gm. of glucose  $\times$  0.927 = 0.0987 gm. of glycogen).

	Substance (freshly precipitated hydroxides, caustic soda, sodium bicarbonate, fats, or sodium sulphite) used in the experiment as catalyst	Actual amt. of copper oxide formed in gm. in 10 c.c. of the solution taken (Blank)	Amount of copper oxide formed in gm. after the experiment	Amount of substance oxidised in gm. in terms of copper oxide	Percentage amt. of substance oxidised
1.	Ferrous hydroxide	0.2343	0.0831	0.1512	64.5
2.	Cerous hydroxide	"	0.0293	0.2050	87.5
3.	Manganous hydroxide	"	0.0501	0.1842	78.6
4.	Uranous hydroxide	"	0.0433	0.1910	81.5
5.	Cobaltous hydroxide	"	0.0261	0.2082	88.9
6.	Nickelous hydroxide	"	0.0253	0.2090	89.2
7.	Mercuric hydroxide (Wet HgO)	"	0.1585	0.0758	32.35
8.	Chromic hydroxide	"	0.1095	0.1248	53.3
9.	Ferric hydroxide	"	0.0753	0.1590	67.9
10.	Cupric hydroxide	"	0.0707	0.1636	69.8
11.	Caustic soda (= 10 c.c. of N/8)	"	0.1469	0.0874	37.3
12.	Sodium bicarbonate (= 10 c.c. of 1% solution)	"	0.2061	0.0282	12.0
13.	Sodium sulphite (= 10 c.c. of 1% solution)	"	0.1832	0.0511	21.8
14.	Potassium stearate (= 10 c.c. of 1% solution)	"	0.2241	0.0101	4.3
15.	Potassium oleate (= 10 c.c. of 1% solution)	"	0.2161	0.0182	7.8

<sup>1</sup> J. Phys. Chem., 29, 376, 799 (1925); 30, 939 (1926); 32, 1663 (1928).

In this communication the results on the oxidation of glycogen, sodium formate, butter, cholesterol, lecithin, milk, egg white and egg yellow by air at the ordinary temperature occurring either singly or in mixtures in presence of different hydroxides or NaOH or NaHCO<sub>3</sub> or Na<sub>2</sub>SO<sub>4</sub> are shown and we are also recording our experiments showing that the induced oxidations of potassium stearate and potassium oleate are retarded by the presence of different carbohydrates. In presence of carbohydrates and urea, the oxidations of potassium stearate and oleate are more retarded than in presence of carbohydrates alone.

The experimental procedure is the same as described in previous papers and the temperature of the experiment is 25°. The results are given in Tables I-VII.

TABLE II  
*Oxidation of glycogen in mixtures*  
Inductor—Ferrous hydroxide

Estimation of glycogen in presence of freshly precipitated ferrous hydroxide (= 0.0674 gm) with (i) potassium stearate (ii) potassium oleate (iii) glycine (iv) urea and (v) glucose, in neutral solutions. The volume of each of the solutions taken was 10 c.c. of 1% concentration. The volume of air passed was 36.5 litres in 5½ hours.

Substance used in the experiment as retarder	Actual amt. of copper oxide formed in gm. in 10 c.c. of the solution taken (Blank)	Amount of copper oxide formed in gm. after the expt.	Amount of substance oxidised in gm. in terms of copper oxide	Percentage amt. of substance oxidised
1. Potassium stearate	0.2343	0.1103	0.1240	52.9
2. Potassium oleate	"	0.1047	0.1296	55.3
3. Glycine	"	0.1358	0.0985	42.0
4. Urea	"	0.1442	0.0901	38.45
5. Glucose	"	0.1075	0.1268	54.1

TABLE III

Experiments with sodium formate in presence of (i) caustic soda, (ii) sodium bicarbonate, (iii) freshly precipitated ferrous hydroxide and (iv) freshly precipitated cerous hydroxide. The volume of air passed was 36.5 litres in 5½ hours.

Substance used as inductor in the experiment	Amount of inductor in gm.	Actual amount of sodium formate in 10 cc. of the solution taken before the expt. in grms. (Blank)	Amount of sodium formate left after the expt. in gm.	Amount of sodium formate oxidised in gm.	Percentage amount of substance oxidised
1. Caustic soda	0.04	0.0737	0.0606	0.0131	17.8
2. Sodium bicarbonate	0.1	"	0.0656	0.0081	11.0
3. Ferrous hydroxide	0.0648	"	0.0576	0.0161	21.8
4. Cerous hydroxide	0.1069	"	0.0565	0.0172	23.3

It appears from Table III that an aqueous solution of sodium formate can be oxidized by merely passing air at 25° in presence of sodium hydroxide, sodium bicarbonate, ferrous or cerous hydroxide.

TABLE IV  
*Oxidation of Potassium stearate*  
Inductor—Ferrous hydroxide (=0.06476 gm.)

Estimation of potassium stearate in presence of freshly precipitated hydroxide with (i) carbohydrates and (ii) carbohydrates and urea in neutral solution. The volume of air passed was 60 litres in 9 hours. The solutions of carbohydrates, urea and fat were each of 1% concentration.

Substance used in the experiment	Amount of absorption of ICl <sub>3</sub> by fat in terms of N/10 Na <sub>2</sub> S <sub>2</sub> O <sub>3</sub> before expt. (Blank)	Oxidation in presence of carbohydrates		Oxidation in presence of carbohydrates and urea	
		Amount of absorption of ICl <sub>3</sub> by fat left in terms of N/10 Na <sub>2</sub> S <sub>2</sub> O <sub>3</sub> after the experiment	Percentage amt. of fat oxidised	Amount of absorption of ICl <sub>3</sub> by fat in terms of N/10 Na <sub>2</sub> S <sub>2</sub> O <sub>3</sub> left after the experiment	Percentage amt. of fat oxidised
	(1)	(2)	(3)	(4)	(5)
1. Arabinose	5.8 c.c.	2.4 c.c.	58.6	2.5	56.9
2. Galactose	"	2.5	56.9	2.6	55.2
3. Glucose	"	2.8	51.7	3.4	41.3
4. Laevulose	"	2.9	50.0	3.2	44.8
5. Lactose	"	3.0	48.2	3.5	39.5
6. Cane Sugar	"	2.7	53.4	3.5	39.5
7. Maltose	"	2.9	50.0	3.3	43.1
8. Starch	"	2.4	58.6	3.3	43.1

The amount of oxidation of potassium stearate by air with ferrous hydroxide as inductor and in absence of carbohydrates = 63.8%.

The figures in columns 2 and 4 indicate the absorption of ICl<sub>3</sub> by fat left after deducting the absorption of ICl<sub>3</sub> by the respective carbohydrates and urea left in the mixture for which the absorptions were separately made.

TABLE V  
*Oxidation of potassium stearate*  
Inductor—Cerous hydroxide (=0.1069 gm.)

Estimation of potassium stearate in presence of freshly precipitated cerous hydroxide with (i) carbohydrates and (ii) carbohydrates and urea in the neutral solution. The volume of air passed was 60 litres in 9 hours. The solutions of carbohydrates, fat and urea were each of 1% concentration.

TABLE V (Continued)

Substance used in the experiment	In presence of carbohydrates			In presence of carbohydrates and urea	
	Amount of absorption of $\text{ICl}_3$ by fat in terms of $\text{N}/10 \text{Na}_2\text{S}_2\text{O}_8$ before expt. (Blank)	Amount of absorption of $\text{ICl}_3$ by fat in terms of $\text{N}/10 \text{Na}_2\text{S}_2\text{O}_8$ left after the expt.	Percentage amt. of substance oxidised	Amount of absorption of $\text{ICl}_3$ by fat in terms of $\text{N}/10 \text{Na}_2\text{S}_2\text{O}_8$ left after the experiment	Percentage amount of substances oxidised
	(1)	(2)	(3)	(4)	(5)
1. Arabinose	5.8	2.0	65.5	2.2	62.0
2. Galactose	"	2.45	57.7	2.4	58.6
3. Glucose	"	1.6	55.2	3.5	39.6
4. Laevulose	"	2.85	50.9	3.2	44.8
5. Lactose	"	2.9	50.0	3.4	41.4
6. Cane sugar	"	2.7	53.4	3.7	36.2
7. Maltose	"	2.8	51.7	3.4	41.4
8. Starch	"	2.3	60.3	3.2	44.8

The amount of oxidation of potassium stearate by air with cerous hydroxide as inductor and in absence of carbohydrates = 68.9%.

The figures in columns 2 and 4 indicate the absorption of  $\text{ICl}_3$  by fat left after deducting the absorption of  $\text{ICl}_3$  by the respective carbohydrates and urea left in the mixture for which the absorptions were separately made.

TABLE VI

*Oxidation of Potassium Oleate*

Inductor—Ferrous hydroxide (= 0.06476 gm.)

Estimation of potassium oleate in presence of freshly precipitated ferrous hydroxide with (i) carbohydrates and (ii) carbohydrates and urea in neutral solution. The volume of air passed was 60 litres in 9 hours. The solutions of carbohydrates, fats and urea were each of 1% concentration.

Substance used in the experiment	Oxidation of fat in presence of carbohydrates			Oxidation of fat in presence of carbohydrates and urea	
	Amount of absorption of $\text{ICl}_3$ by fat in terms of $\text{N}/10 \text{Na}_2\text{S}_2\text{O}_8$ before expt. (Blank)	Amount of absorption of $\text{ICl}_3$ by fat in terms of $\text{N}/10 \text{Na}_2\text{S}_2\text{O}_8$ left after the expt.	Percentage amt. of substance oxidised	Amount of absorption of $\text{ICl}_3$ by fat in terms of $\text{N}/10 \text{Na}_2\text{S}_2\text{O}_8$ left after the expt.	Percentage amt. of substance oxidised
	(1)	(2)	(3)	(4)	(5)
1. Arabinose	6.6	3.6	45.4	3.9	40.6
2. Galactose	"	3.95	41.7	4.05	38.6
3. Glucose	"	4.05	38.6	4.5	31.8
4. Laevulose	"	4.1	38.0	4.2	36.3
5. Lactose	"	4.3	34.8	4.6	30.3
6. Cane sugar	"	3.9	40.9	4.6	30.3
7. Maltose	"	4.2	36.3	4.4	33.3
8. Starch	"	3.7	43.9	4.4	33.3

The amount of oxidation of potassium oleate by air with ferrous hydroxide as inductor and in absence of carbohydrates = 47%.

The figures in columns 2 and 4 indicate the absorption of  $\text{ICl}_3$  by fat left, after deducting the absorption of  $\text{ICl}_3$  by the respective carbohydrates and urea left in the mixture for which absorptions were separately made.

We have also carried on some experiments on the oxidation of carbohydrates, fats and nitrogenous substances either occurring singly or in mixtures by hydrogen peroxide and ferric sulphate. The results are as follows:

TABLE VII (a)

Experiments on oxidation of carbohydrates, nitrogenous substances and fats by hydrogen peroxide in presence of ferric sulphate at  $50^\circ$ . The volume of each of the substances under investigation was 10 c.c. of M/10 concentration, where M represents a molecule of the substance. The volume of ferric sulphate taken was 1 c.c. (= 0.00158 gm. of  $\text{Fe}_2\text{O}_3$ ). Time of oxidation was 2 hours in each case.

Substance used in the experiment	Percentage amount of oxidation of substances occurring singly or in presence of						
	(1) Singly	(2) Glycine	(3) Potassium oleate	(4) Potassium stearate	(5) Potassium palmitate	(6) Glycine oleate	(7) Glycine stearate
1. Glucose	78.3	70.0	12.5	33.0	23.3	29.3	25.5
2. Starch	69.6	59.5	27.7	35.8	—	44.4	54.3
3. Cane sugar	90.0	—	—	—	24.8	—	—
4. Maltose	93.0	—	—	—	86.5	—	—
5. Lactose	92.4	—	—	—	84.5	—	—

TABLE VII (b)

Substance used in the experiment	Percentage amount of oxidation of substances occurring singly or in presence of				
	(1) Singly	(2) Glucose	(3) Starch	(4) Glucose potassium oleate	(5) Glucose glycine
1. Glycine	32.8	17.2	20.0	15.4	—
2. Potassium oleate	70.7	30.9	32.1	—	28.6

The foregoing results prove that the oxidations of glucose, starch, cane-sugar, maltose and lactose by  $\text{H}_2\text{O}_2$  and ferric salts are retarded by glycine, potassium oleate and potassium palmitate.

Similarly the oxidations of glycine and potassium oleate by  $\text{H}_2\text{O}_2$  and ferric sulphate are retarded by glucose, starch, etc. The retardation of the oxidation of carbohydrates is more pronounced in presence of fats than glycine.

In order to find out whether the carbohydrates, fats and nitrogenous substances are oxidized completely to carbon dioxide or other intermediate products were formed, we have estimated the amount of carbon dioxide obtained in these oxidations in potash bulbs. The amount of oxidation of these substances was in all cases also estimated by direct analysis as in previous cases. The experimental results are recorded in Tables VIII-X.

TABLE VIII  
Inductor—Fe(OH)<sub>2</sub>

Experiments on the oxidation of carbohydrates, proteins and fats, in presence of freshly precipitated ferrous hydroxide and the estimation of carbon dioxide formed. The volume of air passed was 75 litres in 11 hours. The amount of ferrous hydroxide used was 0.06476 gm.

Substance used in the experiment	Amount of Substance taken in 10 c.c. of the solution before	Amount of CO <sub>2</sub> formed as found by expt.	Amount of substance oxidised as calculated from the value of CO <sub>2</sub> found	Percentage amt. of substance oxidised	Amount of substance oxidised as found by direct estimation	Percentage amt. of substance oxidised
expt (Blank)						
1. Glucose	0.1255 gm.	0.0529	0.0369	36.9	0.0427	24.0
2. Glycine	0.0915 "	0.0217	0.0185	18.5	0.0180	19.6
3. Potassium oleate	5.5 c.c. (=0.1 gm.)	0.0224	0.0091	9.1*	0.6 c.c.	10.9
4. Lecithin	5.0 c.c. (=0.1 gm.)	0.0206	0.0086	8.6	0.45 c.c.	9.0
5. Cholesterol	1.35 c.c. (=0.035 gm.)	0.0182	0.0059	16.9	0.20 c.c.	14.8
6. Milk	10.75 c.c.	0.0203	—	—	1.65 c.c.	13.5
7. Egg-yellow (5% sol'n).	6.7 c.c. (0.5 gm.)	0.0134	—	—	3.70 c.c.	55.2
8. Egg-white (1% sol'n).	0.75 c.c. (0.1 gm.)	0.0125	—	—	0.05 c.c.	6.7
9. Egg-white (5% sol'n).	1.6 c.c. (0.5 gm.)	—	—	—	0.30 c.c.	18.75

*N.B.* The figures in Nos. 3 to 5 represent the amount of absorption of ICl<sub>3</sub> by the fat in terms of N/10 Na<sub>2</sub>S<sub>2</sub>O<sub>3</sub> and in nos. 6 to 9 the amount of absorption of ammonia by the acid—as determined by Kjeldahl's method—in terms of N/10 NaOH before and after the experiments.

In the case of potassium oleate, the amount of carbon dioxide obtained by experiment was a little lower than the calculated amount and this low value may be due to the absorption of CO<sub>2</sub> by the alkali set free by the hydrolysis of potassium oleate.

We have tried to obtain quantitative and comparative results on the amount of oxidation of carbohydrates, fats and proteins by air and thus establish whether fats or carbohydrates or nitrogenous substances are more readily oxidised in the system or outside. The experimental results are given in Tables XI-XV.

Comparative experiments on the oxidation of carbohydrates, nitrogenous substances and fats in presence of (i) caustic soda and (ii) sodium carbonate and in absence of any inductor.



TABLE IX

Inductor—Ce(OH)<sub>3</sub>:

Experiments on the oxidation of carbohydrates, proteins and fats in presence of freshly precipitated cerous hydroxide and the estimation of carbon dioxide formed. The volume of air passed was 75 litres in 11 hours. The amount of cerous hydroxide used was 0.1069 gm.

Substance used in the expt.	Amount of substance taken in 10 c.c. of the solution before expt. (Blank)	Amount of CO <sub>2</sub> formed as found by experiment	Amount of substance oxidised as calculated from the value of CO <sub>2</sub> found	Percentage amt. of substance oxidised	Amount of substance oxidised as found by direct estimation	Percentage amount of substance oxidised
1. Glucose	0.1034	0.0174	0.0120	12.0	0.0130	12.6
2. Glycine	0.0900	0.0562	0.0479	47.9	0.04275	47.5
3. Potassium oleate	5.5 c.c. N/10 Na <sub>2</sub> S <sub>2</sub> O <sub>3</sub> (0.1 gm.)	0.0184	0.0074	7.4*	0.55 c.c. N/10 Na <sub>2</sub> S <sub>2</sub> O <sub>3</sub>	10.0
4. Lecithin	5.0 c.c. N/10 Na <sub>2</sub> S <sub>2</sub> O <sub>3</sub> (0.1 gm.)	0.0186	0.0078	7.8	0.40 c.c. "	8.0
5. Cholesterol	1.35 c.c. N/10 Na <sub>2</sub> S <sub>2</sub> O <sub>3</sub> (0.035 gm.)	0.0153	0.0050	14.3	0.20 c.c. "	14.8
6. Milk	10.75 c.c. N/10 NaOH	0.0221	—	—	1.45 c.c. N/10 NaOH	15.4
7. Egg-yellow (5% solution)—	6.7 c.c. N/10 NaOH(0.5 gm.)	0.0189	—	—	3.8 cc. "	56.7
8. Egg-white (1% solution)	0.75 c.c. N/10 NaOH(0.1 gm.)	0.0378	—	—	complete	100.0
9. Egg-white (5% solution)	1.6 c.c. N/10 NaOH (0.5 gm.)	—	—	—	1.3 c.c. N/10 NaOH	81.25

\* In the case of potassium oleate, the amount of CO<sub>2</sub> obtained by experiment was a little lower than the calculated amount and this low value may be due to the absorption of CO<sub>2</sub> by the alkali set free by hydrolysis of potassium oleate.

TABLE X

Inductor— $\text{Na}_2\text{SO}_3$ 

Experiments on the oxidation of carbohydrates, proteins and fats in presence of sodium sulphite (K0.1513 gm.) and the estimation of carbon dioxide formed. The volume of air passed was 75 litres in 11 hours.

Substance used in the experiment	Amount of substance taken in 10 c.c. of the solution before experiment (Blank)	Amount of $\text{CO}_2$ formed as found by experiment	Amount of substance oxidised as calculated from the value of $\text{CO}_2$ found	Percentage amount of substance oxidised	Amount of substance oxidised as found by direct estimation	Percentage amount of substance oxidised
1. Glucose	0.0962 gm.	0.0406	0.0277	27.7*	0.0347	36.0
2. Glycine	0.0915 "	0.0320	0.027	27.0	—	—
3. Potassium oleate	6.5 c.c. (0.1 gm.)	0.0120	0.005	5.0*	0.45 c.c.	6.9
4. Lecithin	5.0 c.c. (0.1 gm.)	0.0165	0.0069	6.9	0.35 c.c.	8.1
5. Cholesterol	1.35 c.c. (0.035 gm.)	0.0442	0.0144	41.1	0.55 c.c.	40.8
6. Milk	10.75 c.c.	0.01265	—	—	1.05 c.c.	9.7
7. Egg-yellow (5% solution)	6.7 c.c. (0.5 gm.)	0.0112	—	—	3.85 c.c.	57.5
8. Egg-white (1% sol'n)	0.75 c.c. (0.1 gm.)	0.0291	—	—	0.15 c.c.	20.0
9. Egg-white (5% " )	1.6 c.c. (0.5 gm.)	—	—	—	0.3 c.c.	18.75

N.B. The figures in nos. 3 to 5 represent the amount of absorption of  $\text{ICl}_3$  by the fat in terms of  $\text{N}/10 \text{ Na}_2\text{S}_2\text{O}_3$  and in nos. 6 to 9 the amount of absorption of ammonia by the acid—as determined by Kjeldahl's method—in terms of  $\text{N}/10 \text{ NaOH}$  before and after the experiments.

\* In the case of potassium oleate and glucose the amount of  $\text{CO}_2$  as obtained by experiment was a little lower than the calculated amount and this low value may be due to the absorption of  $\text{CO}_2$  by the alkali set free by the hydrolysis of potassium oleate and sodium sulphite.

TABLE XI

## In presence of NaOH

In the experiments the volume of each of the solutions taken was 10 c.c. of 1% concentration. The volume of air passed was 36.5 litres in  $5\frac{1}{2}$  hours and the amount of alkali used was 10 c.c. of N/10 NaOH (= 0.04 gm.)

Substance used in the experiment	Actual amt. of substance in 10 c.c. of the solution (Blank)	Amount of substance left after the expt.	Amount of substance oxidised	Percentage amount of substance oxidised
1. Glucose	0.0962 gm	0.0857 gm.	0.0105 gm.	10.9
2. Starch	0.1027 "	0.0701 "	0.0326 "	31.7
3. Alanine	0.0997 "	0.0730 "	0.0267 "	26.8
4. Glycine	0.0999 "	0.0750 "	0.0249 "	24.9
5. Potassium stearate*	0.55 c.c.	0.35 c.c.	0.20 c.c.	36.3
6. Potassium oleate*	5.85 c.c.	4.35 c.c.	1.5 c.c.	26.5

\* The figures indicate the amount of absorption of  $\text{ICl}_3$  by fat in terms of N/10  $\text{Na}_2\text{S}_2\text{O}_3$  before and after the experiment.

TABLE XII

In presence of  $\text{NaHCO}_3$ 

In these experiments the volume of each of the solutions taken was 10 c.c. of 1% concentration. The volume of air passed was 36.5 litres in  $5\frac{1}{2}$  hours and the amount of bicarbonate used was 0.1 gm.

Substance used in the experiment	Actual amount of substance in 10 c.c. of the solution (Blank)	Amount of substance left after the experiment	Amount of substance oxidised	Percentage amount of substance oxidised
1. Glucose	0.0962	0.0779	0.0183	19.0
2. Starch	0.1027	0.0658	0.0367	35.9
3. Alanine	0.0997	0.0703	0.0294	29.5
4. Glycine	0.0999	0.0682	0.0317	31.5
5. Potassium stearate*	0.55 c.c.	0.40 c.c.	0.15 c.c.	30.0
6. Potassium oleate*	5.85 c.c.	5.2 c.c.	0.65 c.c.	11.2

\* The figures indicate the amount of absorption of  $\text{ICl}_3$  by fat in terms of N/10  $\text{Na}_2\text{S}_2\text{O}_3$  before and after the experiment.

Comparative experiments with carbohydrates, proteins and fats in presence of (i) freshly precipitated cerous hydroxide, (ii) sodium bicarbonate and (iii) caustic soda.

TABLE XIII

In presence of cerous hydroxide (=0.1069 gm.). Estimation of carbohydrates, nitrogenous substances and fat in presence of freshly precipitated cerous hydroxide. The volume of air passed was 60 litres in 9 hours.

Substance used in the experiment	Amount of substance taken in 10 c.c. of the solution before experiment (Blank)	Amount of substance left after the expt.	Amount of substance oxidised	Percentage amount of substance oxidised
1. Egg-white (5% solution)	1.5 c.c.	0.25 c.c.	1.3 c.c.	83.3
2. Egg-yellow (5% solution)	8.35 c.c.	2.55 c.c.	5.8 c.c.	69.4
3. Starch	0.1027 gm.	0.0439 gm.	0.0588 gm.	57.2
4. Glucose	0.1034 "	0.0657 "	0.0377 "	36.5
5. Butter (=0.9320 gm.)	12.7 c.c.	8.9 c.c.	3.8 c.c.	29.9

N.B. The figures in nos. 1 and 2 represent the amount of absorption of ammonia by the acid—as determined by Kjeldahl's method—in terms of N/10 NaOH and in no. 5, the absorption of ICl<sub>3</sub> by butter in terms of N/10 Na<sub>2</sub>S<sub>2</sub>O<sub>3</sub>.

TABLE XIV

In presence of sodium bicarbonate (=0.10 gm.). Estimation of carbohydrates, fat and nitrogenous substances in presence of sodium bicarbonate. The volume of air passed was 60 litres in 9 hours.

Substance used in the expt.	Amount of substance taken in c.c. of the solution before experiment (Blank)	Amount of substance left after the expt.	Amount of substance oxidised	Percentage amount of substance oxidised
1. Starch	0.1027 gm.	0.0699 gm.	0.0328 gm.	31.9
2. Butter (=0.932 gm.)	12.7 c.c.	9.4 c.c.	3.3 c.c.	26.0
3. Glucose	0.1034 gm.	0.0896 gm.	0.0138 gm.	13.3
4. Egg-yellow (=5% solution)—	8.35 c.c.	7.35 c.c.	1.00 c.c.	12.0
5. Egg-white (=5% solution).	1.55 c.c.	1.40 c.c.	0.15 c.c.	9.7

The figures in no. 2 (2) represent the amount of absorption of ICl<sub>3</sub> by butter in terms of N/10 Na<sub>2</sub>S<sub>2</sub>O<sub>3</sub> and in nos. 4 and 5 the amount of absorption of ammonia by the acid—as determined by Kjeldahl's method in terms of N/10 NaOH.

The foregoing results show that in presence of sodium bicarbonate, the oxidation of egg-yellow and egg-white is much less than in presence of cerous hydroxide in neutral solution. It seems likely that the fat present in egg is partly separated and saponified and this fat retards the oxidation of the protein matter of egg.

TABLE XV

In presence of caustic soda (=0.04 gm.) Estimation of carbohydrates, fat and nitrogenous substances in presence of caustic soda. The volume of air passed was 60 litres in 9 hours.

Substance used in the experiment	Amount of substance taken in 10 c.c. of the solution before experiment (Blank)	Amount of substance left after the experiment	Amount of substance oxidised	Percentage amount of substance oxidised
1. Starch	0.1027 gm.	0.0661 gm.	0.0466 gm.	45.3
2. Egg-yellow (=5% solution)	8.35 c.c.	5.95 c.c.	2.4 c.c.	28.7
3. Egg-white (=5% solution)	1.55 c.c.	1.20 c.c.	0.35 c.c.	22.5
4. Butter (=0.932 gm.)	12.7 "	10.2 "	2.50 "	19.7
5. Glucose	0.1034 gm.	0.0839 gm.	0.0195 gm.	18.8

The figures in nos. 2 and 3 represent the amount of absorption of ammonia by acid as determined by Kjeldahl's method in terms of N/10 NaOH and in no. 4 the amount of absorption of  $\text{ICl}_3$  by butter in terms of N/10  $\text{Na}_2\text{S}_2\text{O}_3$ .

In this case also, the oxidation of the protein matter in eggs, appears to be retarded by the partially saponified fat also present in the eggs.

#### Discussion

The experimental results recorded in Table I show that glycogen can be oxidised by passing air at the ordinary temperature in presence of one of the following substances:

$\text{NaHCO}_3$ ,  $\text{NaOH}$ ,  $\text{Na}_2\text{SO}_3$ ,  $\text{Fe}(\text{OH})_2$ ,  $\text{Ce}(\text{OH})_3$ ,  $\text{Mn}(\text{OH})_2$ ,  $\text{UO}_2(\text{OH})_2$ ,  $\text{Co}(\text{OH})_2$ ,  $\text{Ni}(\text{OH})_2$ ,  $\text{HgO}$ ,  $\text{Cr}(\text{OH})_3$ ,  $\text{Fe}(\text{OH})_3$ ,  $\text{Cu}(\text{OH})_2$ . From the results recorded in Table II, it will be observed that the amount of glycogen oxidised by air at the ordinary temperature with ferrous hydroxide as the inductor is decreased by potassium stearate, oleate, glycine, urea, and glucose; and all these latter substances are also simultaneously oxidised along with glycogen.

These results on the slow and induced oxidation of glycogen are interesting in view of the fact that glycogen, which is present in liver and muscle, is looked upon as a reserve form of carbohydrate which plays very much the same role in animal metabolism as starch does in plant life. Moreover glycogen stands in very close connection with the general questions of carbohydrate metabolism. The results recorded in Tables IV, V and VI show that the induced oxidation of potassium stearate and oleate by air at the ordinary temperature is appreciably retarded by arabinose, galactose, glucose, laevulose, lactose, cane sugar, maltose, and starch. Moreover, in presence both of urea and carbohydrates the oxidation of potassium stearate and

oleate is more retarded than in presence of carbohydrates alone. These results are likely to throw considerable light on the metabolism in the animal body in normal health and diabetes.

The function of the fats is, like that of the carbohydrates, to supply heat and energy. Within certain limits, fats and carbohydrates can be used alternatively in the diet. If all the carbohydrate in the food be replaced by fats, the fat is incompletely oxidised; in other words, carbohydrate burns more easily than fat and for complete combustion of fat in the body, carbohydrate must be burned along with it. Very little carbohydrate and a great deal of fat are eaten by the Eskimos but they eat an abnormal amount of protein; in this case the proteins act like carbohydrates in retarding the oxidation and assisting in the complete oxidation (combustion) of fat.

The foregoing results show that the amount of carbon dioxide obtained in these slow oxidations is practically the same as is expected from the point of view that the carbohydrates, fats and nitrogenous substances are completely oxidised into carbon dioxide and water by passing air at the ordinary temperature. We venture to think that these results are of importance because these oxidations are of the same type as those taking place in the animal body.

The oxidation of organic substances by hydrogen peroxide and iron salts has been investigated by Dakin and co-workers and others, but in these cases several complex intermediate products are obtained and these slow oxidations appear different from those taking place in the animal body. As far as we know we have been the first to prove conclusively in a systematic manner that fats, carbohydrates, nitrogenous and other organic substances can be completely oxidised into their main end products, carbon dioxide and water by air with the help of an inductor or in presence of light at the ordinary temperature and have thus been able to imitate successfully the physiological processes of oxidation on which animal life depends.

Voit stated "that the metabolism in the body was not proportional to the combustibility of the substances outside the body, but that protein which burns with difficulty outside metabolises with the greatest ease, then carbohydrates, while fat which readily burns outside is the most difficultly combustible in the body."

This conclusion was arrived at by Voit from actual feeding experiments on animals.

We have obtained quantitative and comparative results on the velocity of oxidation of fats, proteins, and carbohydrates by air and thus tried to establish whether fats or carbohydrates are oxidised more readily in the system.

Our experimental results (Vide Table XIII) show that the order in which they are oxidised in presence of cerous hydroxide are as follows:

Egg-white > egg-yellow > starch > glucose > butter; whereas the orders are different in presence of sodium bicarbonate or caustic soda. In presence of cerous hydroxide, the induced oxidation of fats, nitrogenous substances and carbohydrates follow the same order as stated by Voit.

Further work in this line is in progress in these laboratories.

### Summary

(1). An aqueous solution of sodium formate and an aqueous suspension of glycogen have been oxidized by air at 25° in presence of NaOH, NaHCO<sub>3</sub>, and different metallic hydroxides.

(2). The oxidation of glycogen is retarded by fats and nitrogenous substances.

(3). The induced oxidation of potassium stearate and oleate by air is retarded by carbohydrates and to a greater extent by a mixture of carbohydrate and urea.

(4). The oxidation of carbohydrates by H<sub>2</sub>O<sub>2</sub> and ferric sulphate is retarded by glycine, potassium, stearate and oleate.

(5). Experimental results on the estimation of carbon dioxide prove that glucose, glycine, potassium oleate, lecithin, cholesterol, milk, egg yellow and egg white are oxidized by air at 25° in presence of inductors chiefly to carbon dioxide and not to any intermediate product.

(6). Comparative experiments have been carried on the induced oxidation of fats, carbohydrates and nitrogenous substances to prove whether nitrogenous matter is more readily oxidized than carbohydrates. The results show that in neutral solutions with cerous hydroxide as an inductor, the order in which oxidation takes place is as follows: egg-white > egg-yellow > starch > glucose > butter. This order is the same as stated by Voit, the eminent physiologist from physiological experiments.

(7). These results on slow and induced oxidation of fats, nitrogenous substances and carbohydrates occurring either singly or in mixtures by air at ordinary temperatures, are important, because these oxidations are of the same type as those taking place in the animal body.

*Chemical Laboratory,  
Allahabad, India.  
February 6, 1929.*

## ADSORPTION AT CRYSTAL-SOLUTION INTERFACES\*

### IV. Macroscopic Ammonium, Cesium and Potassium Alum Crystals grown in the Presence of Dyes and other Foreign Materials.

BY M. E. LASH AND W. G. FRANCE

#### Introduction

In previous articles the growth<sup>1</sup> and solution of single copper sulfate crystals and the growth of potassium alum<sup>2</sup> and ammonium alum<sup>3</sup> crystals in the presence of dyes was studied. It was found that dyes modified the velocity of perpendicular displacement of the crystal faces and also modified the crystal habit. These effects were attributed to the specific adsorption of the dyes at the crystal-solution interface. The present investigation is a continuation of the study of selective adsorption by crystal faces using ammonium, potassium, and cesium alum crystals.

The work consists of (A) the determination of the growth ratio of ammonium alum in the presence of two dyes and also for the pure alum using cubic seed crystals. (B) A comparison of the effects of various dyes upon the crystal habit of ammonium, potassium and cesium alum. (C) A study of the influence of the state of dispersion of dyes in alum solution upon their effectiveness in modifying the crystal habit. (D) An attempt to ascertain the thickness of the layer of dye adsorbed on the ionic planes of the crystal during its growth. (E) The measurement of the interfacial angles of a crystal containing adsorbed dye.

#### Experimental

##### A. Growth Ratio Measurements.

###### (1) The Growth Ratio of Ammonium Alum as affected by Dyes.

By growth ratio is meant the ratio of the perpendicular displacement of the cube faces to that of the octahedral faces of the alum crystal. In the previous papers of this series of investigations it has been shown that the determination of this ratio affords a measure of the repressing effect of foreign substances upon the growth rate of the faces.

The study undertaken required close control of the conditions of temperature and humidity and made use of a motion picture record of the growth of individual macroscopic crystals. The apparatus used was essentially that described by Keenen, Bennett and France<sup>4</sup> and consisted of a large air thermostat and three mechanical units; (1) the thermal regulator, (2) the illuminating and optical system and (3) the automatic mechanism controlling the camera and illuminating system.

\* In part from the dissertation presented to the Graduate School of The Ohio State University by M. E. Lash, August 1928 in partial requirement for the Ph.D. degree.

<sup>1</sup> T. S. Eckert and W. G. France: *J. Am. Ceramic Soc.*, 10, 579 (1927).

<sup>2</sup> F. G. Keenen and W. G. France: *J. Am. Ceramic Soc.*, 10, 821 (1927).

<sup>3</sup> G. W. Bennett and W. G. France: *J. Am. Ceramic Soc.*, 11, 571 (1928).

<sup>4</sup> Keenen, Bennett and France: *J. Am. Ceramic Soc.*, 10, 435 (1927).



The procedure followed was that previously developed in this laboratory and described in detail by Bennett and France.

Ammonium alum crystallizes in cubo-octahedrons. The principal face is the octahedral and while cube faces are always present in the normal crystal, they are usually quite small. Frequently when foreign materials are adsorbed by a given face the adsorption retards the perpendicular growth, with the result that that area of such a face increases and often exceeds the principal faces in area. One can therefore usually determine whether or not a substance is adsorbed by observing if the habit of the crystals is changed when they are grown in the presence of the foreign material.

Preliminary to the growth ratio measurements, qualitative tests were made. Small crystals of ammonium alum were secured to nichrome wires and allowed to grow in saturated solutions containing from one half to one percent of foreign material. Thirty-nine compounds which contain polar groups such as NH<sub>2</sub>, OH, SO<sub>3</sub>Na and COOH were found to have no effect upon the crystal habit of ammonium alum. These compounds are given in Table I. A new series of eighteen dyes was tried in a similar manner; all but four were without effect. These are designated by the numbers 4, 11, 12 and 13 and their formulas are shown below.

Dye No. 4.

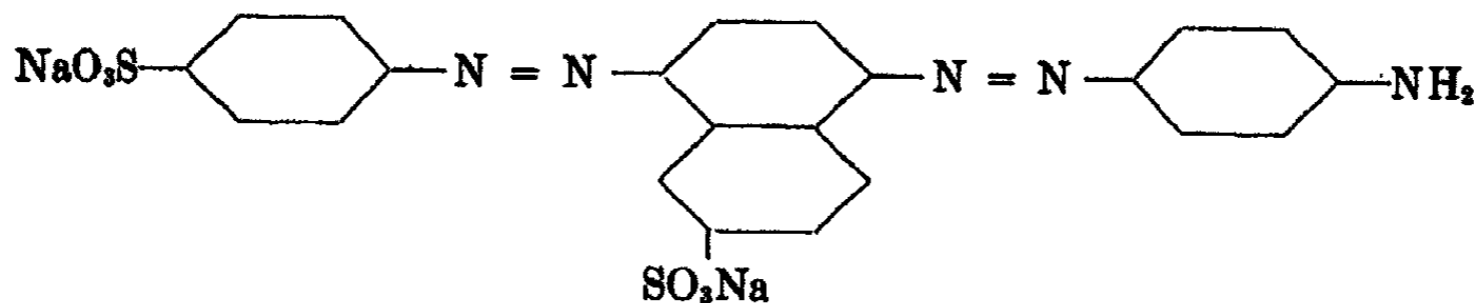

Dye No. 11.

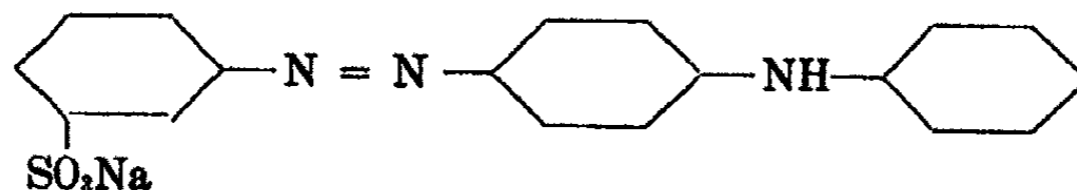

Dye No. 12.

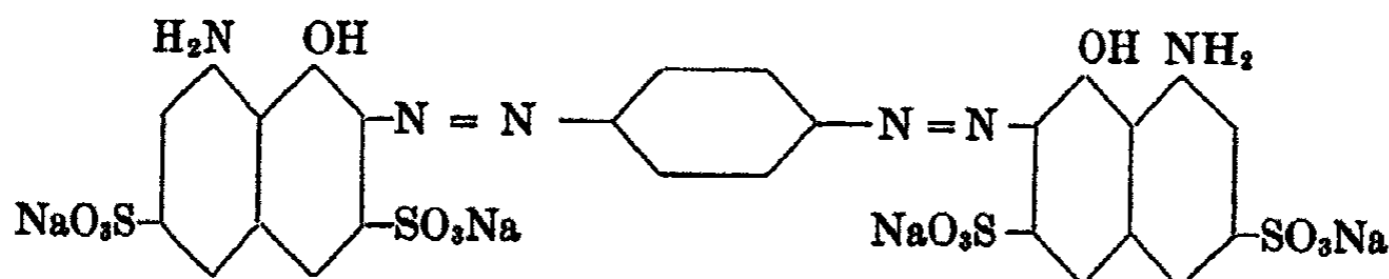

Dye No. 13.

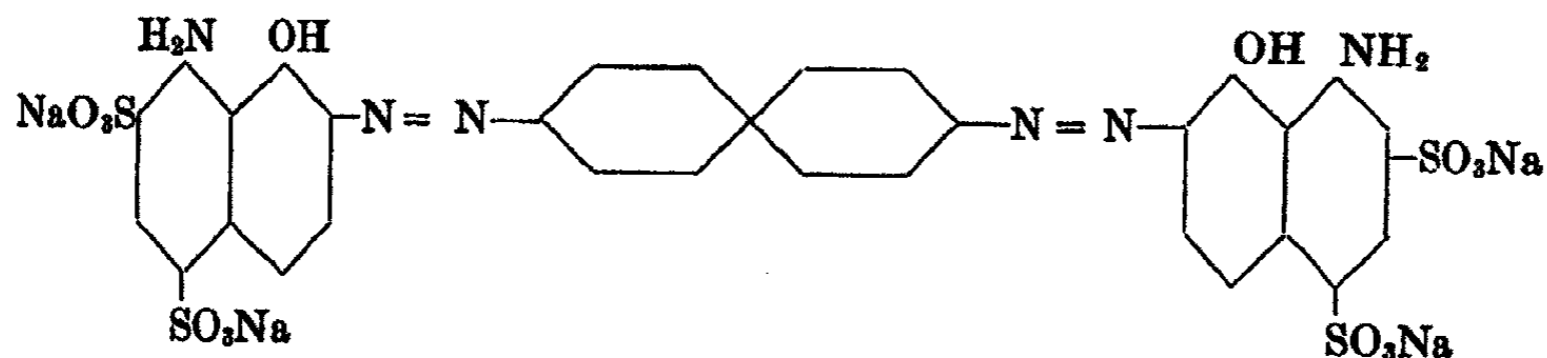

TABLE I  
Compound added

Compound added	Effect on Ammonium Alum Crystal	
Acetamide.....	No effect	
Hydroquinone.....	" "	
Hexamethylene tetramine.....	" "	
Raffinose.....	" "	
Hippuric acid.....	" "	
Leucine.....	" "	
Alanine.....	" "	
Phenyl alanine.....	" "	
Guanidine hydrochloride.....	" "	
Cocaine hydrochloride.....	" "	
Phthalimide.....	" "	'
Diphenylamine.....	" "	i
2,4, Dinitro phenol.....	" "	]
Propyl resorcinol.....	" "	
Benzidine.....	" "	
Picric acid.....	" "	
P Magnesium phenol sulfonate.....	" "	
B Naphthalene sulfonic acid.....	" "	
P Toluene sulfonyl aniline.....	" "	
Sodium-p-toluene sulfonate.....	" "	
Sulfanilic acid.....	" "	
2 Amino toluene 4 sulfonic acid.....	" "	
Alpha naphthylamine chloride.....	" "	
Hydroxylamine hydrochloride.....	" "	
Hydrazine hydrochloride.....	" "	
Sodium-p-phenol azobenzene sulfonate.....	" "	1
Ortho aminophenol.....	" "	1
Acetoxime.....	" "	
Ethyl urethane.....	" "	"
Ethyl-p-toluene sulfonate.....	" "	1
Benzidine sulfate.....	" "	
2 Naphthylamine 7 sulfonic acid.....	" "	
Dicyandiamid.....	" "	
Acetaldehyde sodium bisulfite.....	" "	B
Ethyl chlorohydrin.....	" "	i
Acetaldehyde.....	" "	x
Methyl p-amidophenol.....	" "	
Glycine.....	" "	'

TABLE II  
Data (Summarized)  
Dye No. 4

Expt.	100	111	Ratio	g. dye per 100 cc.
1.	0.5	8.9	0.06	0.00500
4.	1.4	7.7	0.18	0.00375
5.		not used—film fogged		
2.	2.6	5.5	0.47	0.00250
6.	2.2	5.0	0.44	0.00182
3.	4.0	4.2	0.95	0.00125
7.	3.5	3.0 <sup>a</sup>	1.17	0.00100
8.	5.5	3.6	1.53	0.00075

Dye No. 13

Expt.	100	111	Ratio	g. dye per 100 cc.
1.	1.3	12.2	0.11	0.00250
2.	0.4	6.3	0.06	0.00125
3.	2.1	7.8	0.27	0.00080
4.	1.6	6.9	0.23	0.00050
5.		not used—crystal irregular		
7.	5.4	5.2	1.04	0.00030
6.	3.6	2.3	1.57	0.00020
8.	4.8	3.2	1.50	0.00020

TABLE II  
Data (Summarized)  
Pure Alum from Cubical Seed Crystals

Expt.	100	111	Ratio	Deviation
1.	11.2	5.1	2.20	-5.1%
2.	11.9	5.0	2.38	+2.6
3.	9.3	4.0	2.32	0.0
4.	10.6	4.4	1.40	+3.4

Mean of ratios  $2.32 \pm 0.03$   
Average deviation 2.8%

Dye No. 12 repressed the perpendicular growth of the cube faces only slightly. These dyes were of a high degree of purity and it is believed that the effects observed are the result of the action of the dyes rather than of any impurities present. Such impurities as NaCl, alpha-naphthylamine, and diphenylamine which may have been present in small amounts were found to have no effect on the alum even when present in concentrations as high as one half percent. Before being used for the growth ratio measurements these dyes were further purified by repeated salting out of water solution and subsequent recrystallization.

Dyes No. 4 and No. 13 only were used in the growth ratio determinations. Dye No. 12 could not be used because at the concentration necessary to affect the growth ratio, the limited amount of light which passed through the solution was insufficient to affect the photographic film. Dye No. 11 could not be used for similar reasons, particularly because the color of the dye in alum solution is deep red which rendered the transmitted light low in actinic value.

The data and results obtained in these measurements are summarized in Table II. The columns (100) and (111) represent the perpendicular displacements between parallel cube

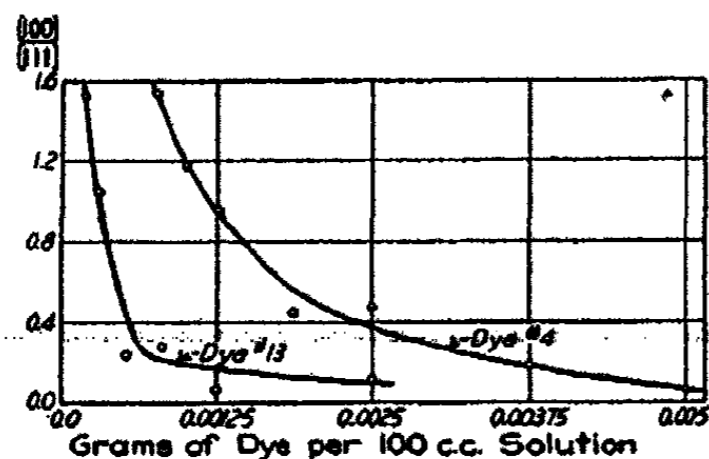

FIG. 1

would be different if instead of a normal crystal with octahedral faces present, a seed crystal having only cube faces, was used. Due to the large area of the cube faces compared to that of the octahedral faces, the velocity of their perpendicular displacement should be greater. Seed crystals for these measurements were obtained by mounting very small crystals of ammonium alum on copper wires by plunging the heated end of the wire into the crystal. They were allowed to grow in a solution of the salt containing 0.01 percent of dye No. 4. The resulting crystals were very nearly perfect cubes and weighed about 0.2 gram.

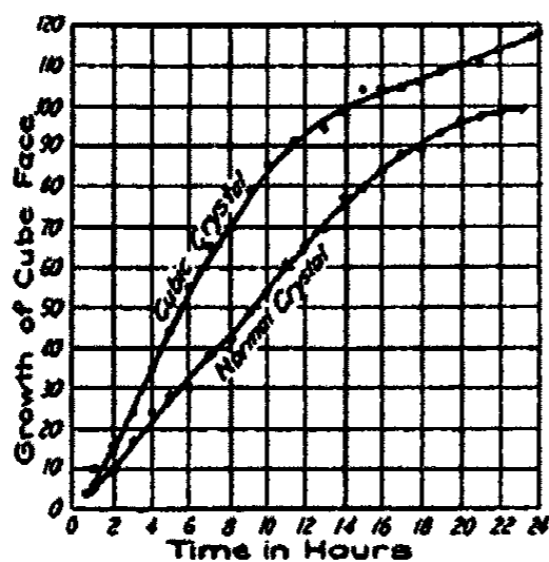

FIG. 2

Growth Rates of Ammonium Alum

and normally shaped crystals.

#### B. A Comparison of the Effects of Dyes upon the Crystal Habit of Ammonium and Cesium Alums.

In part (A) the effect of eighteen dyes upon the crystal habit of ammonium alum was determined. The procedure was repeated using potassium alum with the same results except for dye No. 12 which was without effect.

It was thought advisable to determine whether those dyes which modified the habit of ammonium and potassium alum, would also produce the same effects on cesium alum. Due to the low solubility of cesium alum only

placements between parallel cube and parallel octahedral faces respectively. The results are also shown graphically in Fig. 1.

#### (2) Growth Ratio of Pure Ammonium Alum when grown from Cubical Seed Crystals.

The growth ratio for ammonium alum has been found by Bennett and France to be 1.53. However it might be expected that this ratio

They were allowed to grow in a solution of the salt containing 0.01 percent of dye No. 4. The resulting crystals were very nearly perfect cubes and weighed about 0.2 gram.

The data and results are summarized in Table III. It will be seen that the growth ratio  $V_{100}/V_{111}$  is 2.32. Fig. 2 shows the time rate of the perpendicular displacement of the cube face for both cubical

small crystals were obtained and no growth ratios were measured. The dyes were added to the saturated alum solutions which were permitted to evaporate slowly. The crystals formed were removed and examined with a microscope.

Dye No. 13 which modified the habit of both the ammonium and potassium salts colored the crystals uniformly but did not change their shape.

Dye No. 2 which repressed the perpendicular displacement of the cube faces of ammonium alum to a small extent, and which left potassium alum unaffected, had no effect upon the crystal habit of cesium alum, although the crystals were uniformly colored.

Oxamine blue and dye No. 11, both of which were effective in modifying the crystal habit of ammonium and potassium alums behaved similarly with cesium alum.

Bismarck brown which did not modify the crystal habit of ammonium alum, and which affected that of potassium alum was found to have a very pronounced effect upon cesium alum. The crystals produced were brown and nearly perfect cubes.

#### C. The State of Dispersion of Dyes in Saturated Alum Solutions.

A Zsigmondy slit ultramicroscope was used to examine the dyes both in pure water and saturated alum solutions in order to determine their state of dispersion. The solutions contained about 0.003 percent of dye. In all of them, the presence of colloid particles was revealed. The number of particles, however, varied widely among the different solutions. Dyes showing only a few particles were diamine sky blue, dye No. 4, dye No. 13, and anthraquinone green, while oxamine blue, Bismarck brown and dye No. 11 showed a great many; others were intermediate. In connection with these observations the sign of the charge of the colloid particles present in the water solutions was determined. Of the dyes diamine sky blue, oxamine blue, anthraquinone green, Bismarck brown, No. 4, No. 5, No. 11, No. 12, and No. 13, all were negative except Bismarck brown which was positive. There appears to be no relation between the colloidal content or the sign of the charge of the particles and the action of the dyes on the growing crystals.

The process of ultrafiltration was applied to alum solutions containing dyes. Very dense collodion filters removed all the color, less dense filters removed only a part of the color but practically all the colloid particles as shown by examination in the slit ultramicroscope. This indicates that the dyes may be both molecularly and colloiddally dispersed.

#### D. The Relation between the Weight of Dye adsorbed and the Area of the Adsorbing Surface.

The shape of the curves in Fig. 1 suggests the possibility that at small values for the growth ratios, the dyes may be adsorbed in monomolecular layers. The following procedure was used in order to obtain information regarding this point. (1) Five crystals of ammonium alum were selected, uniform as to size and symmetry. (2) The area of the cube faces was determined by use of a microscope equipped with a mechanical stage. (3) The crystals were mounted on nichrome wires and allowed to grow in ammonium

alum solution containing 0.01 per cent of diamine sky blue for eight hours at 30.0 C.  $\pm$  0.2°. (4) The crystals were removed from the solution, dried and weighed. (5) The area of the cube faces was again measured as in (2). (6) The cube faces of the crystals were then very carefully scraped with a razor blade until no more dye was visible. (7) The remnants of the crystals were weighed. This weight, taken from that obtained in (4) gave the weight of alum scraped off the cube faces. (8) The alum and dye scraped off the cube faces were dissolved in water and the weight of dye determined colorimetrically.

Area of cube faces before growth	119.0 mm <sup>2</sup>
Area of cube faces after growth	430.6 "
Wt. of alum scraped off cube faces	0.1928 g.
Wt. of dye adsorbed	0.0000468 g.
Diamine sky blue, molecular weight 992.	

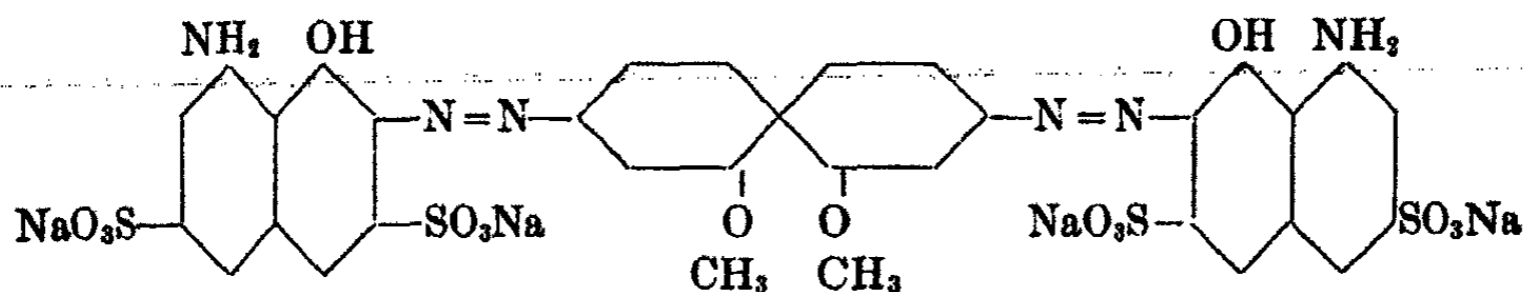

$$(0.0000468/992) \times 6.06 \times 10^{23} = 28.6 \times 10^{16} \text{ molecules of dye adsorbed.}$$

The work of W. H. and W. L. Bragg<sup>1</sup> indicates that the benzene and naphthalene molecules are flat and that the former covers an area of approximately 36 sq. Å., and the latter 54 sq. Å. Assuming that the two naphthalene and two benzene groups of the diamine sky blue molecule lie essentially in one plane, the area covered by these groups would be 180 sq. Å. The area covered by the attached groups is not known but is perhaps less than 180 sq. Å. For the purpose of calculation it will be assumed to be 120 sq. Å, making the total area assumed to be covered by the diamine sky blue molecule 300 sq. Å.

Multiplying 300 sq. Å. by the total number of dye molecules adsorbed, 300 sq. Å  $\times$  28.6  $\times$  10<sup>16</sup> = 858  $\times$  10<sup>16</sup> sq. Å. the total area covered by a monomolecular layer of the dye.

It remains to compare this area with the total area of the ion planes present in the cube faces of the crystals during their growth, that is, the total area of the surface on which the dye was adsorbed.

This total surface area was computed from the above data together with the information given by Wyckoff<sup>2</sup> on the crystal structure of the alum. The volume scraped off the crystal is 0.1928 g.  $\div$  1.645 (the density of alum) = 0.1172 cm<sup>3</sup> or 117.2 mm<sup>3</sup>; and the perpendicular displacement of the cube faces during growth is therefore 117.2 mm<sup>3</sup>  $\div$  430.6 mm<sup>2</sup> = 0.27 mm.

As there are six planes of ions in a distance of 12 Å perpendicular to the cube face in the alum crystal, the number of ion planes on which the dye

<sup>1</sup> W. H. and W. L. Bragg: "X-Rays and Crystal Structure," Chapter 14.

<sup>2</sup> Wyckoff: Am. J. Sci., (5) 205, 209 (1923).

was adsorbed is  $(0.27 \times 10^7 + 12) \times 6 = 13.5 \times 10^6$  and the mean area of the planes is  $(430 \text{ mm}^2 + 119 \text{ mm}^2) \div 2 = 275 \text{ mm}^2$ . Therefore the total area of the adsorbing surface is  $275 \text{ mm}^2 \times 13.5 \times 10^6 = 3712 \times 10^6 \text{ mm}^2 = 3712 \times 10^{10} \text{ sq. } \text{Å}$ , or in round numbers  $3700 \times 10^{10} \text{ sq. } \text{Å}$ . The area covered by the dye molecules themselves has been shown above to be  $858 \times 10^{16} \text{ sq. } \text{Å}$ . A comparison of these areas shows that the area of the surface on which the dye was adsorbed is about 4300 times that covered by the dye if present as a monomolecular layer.

It is realized that the errors in this measurement are necessarily great both because of the lack of adequate technique and because more information is needed regarding the size and shape of the dye molecule, its arrangement in the crystal, and the state of aggregation of the dye in the solution. Therefore no claim is made for the accuracy of the results. The results indicate in a qualitative way that this adsorption is perhaps not in the form of a continuous mono-molecular layer at the ionic planes.

The thickness of the layer of dye adsorbed by crystal powders has been studied by Paneth and Vorwerk<sup>1</sup> and Paneth and Radu<sup>2</sup>. In the case of the adsorption of Ponceau 2 R by lead sulfate, their measurements indicate that when the crystals have taken up a maximum of dye, the surface is covered by a monomolecular layer. Bancroft and Barnett<sup>3</sup> in studying the adsorption of methylene blue by lead sulfate find that the amount of adsorption is a function of the  $p_H$  of the solution and that Paneth's method of determining the total adsorbing surface on the assumption that the dye molecules are present as a monomolecular layer, is in error. However these cases are perhaps not strictly comparable with the work presented in this paper since the adsorption here is by growing crystals whereas Paneth and Bancroft are considering the adsorption by crystal surfaces already developed.

#### E. The Effect of Dye Adsorption on the Interfacial Angles of Ammonium Alum.

A two-circle goniometer was used to measure the angle between the cube and the octahedral faces of an ammonium alum crystal grown in the presence of 0.005 percent dye No. 13. The normal value for this angle is  $54^\circ 44'$ . The angles measured were  $54^\circ 42'$ ;  $54^\circ 38'$ ;  $54^\circ 39'$ .

#### Discussion

The results obtained in this investigation will be considered on the following basis: adsorption of foreign materials by growing crystals is dependent on (1) the nature of the residual valence force fields in the crystal faces; those faces having alternating planes of ions of like charge exhibiting a much greater adsorbing power than those with a checkerboard arrangement of the positive and negative ions; (2) the interionic distances in the crystal lattice; and (3) the presence and spatial arrangement of polar groups in the molecules of the adsorbed material.

<sup>1</sup> Paneth and Vorwerk: *Z. physik. Chem.*, 101, 480 (1922).

<sup>2</sup> Paneth and Radu: *Z. physik. Chem.*, 101, 488 (1922).

<sup>3</sup> Bancroft and Barnett: *Colloid Symposium Monograph*, 6, 73 (1928).

The adsorption of foreign materials by crystals has generally been regarded as very highly specific in character. This specificity of action may be attributed in part to items (2) and (3) in the paragraph above. If adsorption were due only to the presence of polar groups, all substances containing them should be adsorbed. Such is by no means the case. The configuration of the molecule or the distribution of the polar groups is most likely a contributing factor. In support of this idea, one experimental fact may be cited; dyes No. 12 and No. 13 are isomeric, they are identical except for the relative position of the two  $\text{SO}_3\text{Na}$  groups in the naphthalene nucleus. Dye No. 13 was adsorbed by ammonium alum at a very low concentration while dye No. 12 was adsorbed but slightly at a very high concentration.

Korbs<sup>1</sup> discovered that sodium chloride when crystallized in the presence of formamid was octahedral in form, whereas the formamid had no effect on the crystal form of potassium chloride. Since the two salts have identical structures, the specificity of adsorption is most likely due either to the kind of ions present or to the interionic distances in the crystal lattice. Similar behavior has been observed in the comparison of the effect of dyes upon ammonium, potassium and cesium alums. Thus while Bismarck brown is not adsorbed by ammonium alum, it is adsorbed to a moderate extent by potassium alum, and very markedly by cesium alum. Oxamine blue and dye No. 11 are adsorbed by all three salts; dye No. 13 is adsorbed by ammonium and potassium alum but not by cesium alum; dye No. 12 is slightly adsorbed by ammonium alum but not by the other two. This preferential adsorption may be due in part to the difference in the size of the ammonium, potassium, and cesium ions, or to the distances between the ions in the crystal lattice.

The ultramicroscopic examination of the solutions of dye and alum showed that particles of colloidal dimensions were present in all the solutions. Some dyes appeared to be dispersed very largely in the colloidal state and others only slightly so. No relation between the apparent state of dispersion of the dye and its effectiveness in repressing the growth rate of alum was observed. The sign of the charge of the colloid particles does not indicate whether or not a dye will be adsorbed by any given crystal. It would seem then that adsorption of the dyes by the alum crystals is largely independent of the colloidal state and therefore must be dependent upon the molecular or ionic dispersity.

The curves in Fig. 2 show the more rapid growth of the cube faces of ammonium alum when a cubic seed crystal was employed in place of a normally shaped crystal. It should be noted that Loir<sup>2</sup> observed that cubic crystals of alum grew three times as fast as octahedral crystals when both were suspended in pure alum solution. This more rapid growth of the cube faces is to be expected on the basis of the theory of crystal growth advanced by Niggli<sup>3</sup> in which he states that the velocity of the perpendicular displace-

<sup>1</sup> Korbs: *Z. Krist.*, 43, 451 (1907).

<sup>2</sup> Loir: *Compt. rend.*, 92, 1166 (1881).

<sup>3</sup> Niggli: *Z. anorg. allgem. Chem.*, 110, 55 (920).



ment of a crystal face depends on the thickness of the layer of crystallographically unsatisfied ions. The thickness of this layer is maximal for vicinal faces and hence they rapidly disappear. The cube face of the alum crystal has a higher growth velocity than the octahedral; hence if the cube faces are the only ones present, as in the case of the cubic crystals, their perpendicular growth will be more rapid than normal until they are reduced to their usual area or disappear entirely.

From the comparison of the area of the adsorbing surface of the crystals with that which the adsorbed dye could have covered as a continuous monomolecular layer, it is apparent that such a layer is most likely not present in the cases here studied. It is of course recognized that there are large errors involved in the measurements such as the assumption that the dye is molecularly dispersed, whereas ultramicroscopic examination shows that some particles of colloidal dimensions are present, and also the uncertainty of the size of the dye molecule and area of the ionic planes. The adsorbed molecules or ions of the dyes probably produce fields of force around them due to the unsaturation of the polar groups. These force fields may inhibit growth over the entire range of their forces which would extend laterally over considerable area and vertically through several layers of planes of ions.

The break points in the curves (Fig. 1) in which the growth ratios are plotted against dye concentration, may be thought of as representing not a monomolecular layer of adsorbed dye, but a "saturated surface" in which the adsorbed dye exerts an almost completely inhibitory influence upon the further perpendicular displacement of the cube faces.

That there is certain concentration of dye at which this "saturated surface" can be formed was indicated by two determinations of the growth ratio of ammonium alum in the presence of 0.0002 percent of dye No. 13. The curves in Fig. 3 show the distances between the 111 faces plotted against the corresponding distances for the 100 faces, which was the method followed in determining all the growth ratios. At the very low concentration of 0.0002 percent no adsorption took place and the growth ratio has the value of that of pure alum or 1.53. As the solution evaporated, the dye became more concentrated and after reaching a certain value was able to form a "saturated surface" with the result that the perpendicular growth of the cube face was quite suddenly checked as shown by the abrupt break in the curve.

The results obtained from the study of adsorption of dyes by ammonium, potassium and cesium alums are in harmony with the theory previously advanced (1) that adsorption by a growing crystal is closely connected with its structure. (2) that adsorption will take place on those faces populated by ions of like charge and hence with strongest residual valency force fields. (3)

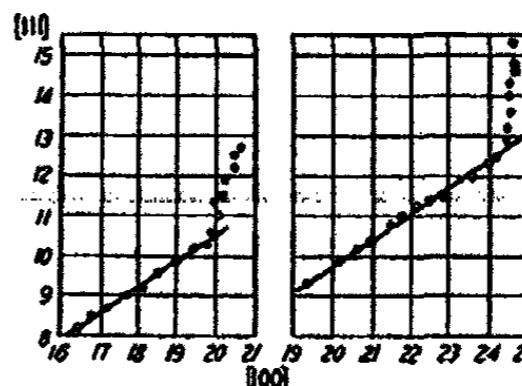

FIG. 3  
Growth Rates of Ammonium Alum  
in the Presence of Dye No. 13  
0.0002 per cent.

that the interionic distances within the faces, and (4) the presence and spatial arrangement of polar groups in the adsorbed material are also factors.

On the basis of the determination of growth ratios, and the weight of adsorbed dye together with the area of the adsorbing surface, it may reasonably be concluded that there is a minimum concentration of dye in the solution at which the dye is adsorbed to form a "saturated surface," and that the dye is present in this "saturated surface" in an amount many times less than that required by a continuous monomolecular layer.

The conclusions drawn in this work are not in agreement with those of Saylor<sup>1</sup> who studied the modification of crystal habit by foreign substances. Drops of saturated solutions containing foreign substances were permitted to evaporate at room temperature on microscope half slides. The development of the crystals was observed through a microscope on the stage of which the half slides were placed. The following quotation, *J. Phys. Chem.*, 32, 1446 is illustrative of his views.

"Using acid and alkaline solutions, their influence upon external crystal form has served as a key to the entire field of adsorption and has tied in with those examples where adsorption can actually be demonstrated. This new technique is absolutely general; it applies to all crystal systems; it applies to crystals growing from solvents other than water; and it can be applied to crystals growing from a melt if the chemistry of the melt is understood sufficiently."

From this the conclusion is drawn that if a given habit results from growth in an acid medium it is due to the adsorption of hydrogen ions and therefore all readily adsorbed cations will produce the same form. If another habit is favored when the crystal is grown in an alkaline medium, this is due to the adsorption of hydroxyl ions and therefore all readily adsorbed anions will produce this form. The statement is also made p. 1455 that "Negative ions are adsorbed on the octahedron faces of the alkali halides and barium nitrate, on the cube faces of potassium alum, and on the pyramids of sodium nitrate. The other principal faces adsorb positive ions."

The results obtained in this laboratory certainly are not in harmony with the above stated generalization. In all the cases studied in which adsorption and modification of the crystal habit occurred, the growth ratio varied in such a way as to indicate adsorption only by those faces populated by ions of like charge. If the other principal faces adsorbed any material at all the effect on the repression of the perpendicular displacement of such faces was negligible in comparison to the effect on the other faces.

In an attempt to reconcile the results of Keenen and France<sup>2</sup> on potassium alum and dyes with his generalization, Saylor decides on the basis of some diffusion experiments that diamine sky blue and Bismarck brown are not

<sup>1</sup> C. H. Saylor: Bancroft's "Applied Colloid Chemistry," 2nd. Ed., p. 198; Colloid Symposium Monograph, 5, 49 (1928); *J. Phys. Chem.*, 32, 1441 (1928).

<sup>2</sup> Keenen and France: *J. Am. Ceramic Soc.*, 10, 821 (1927).

in true solution but that naphthol yellow, quinoline yellow, methyl violet, and methylene blue are. He states: "The dyes which are in true solution do not alter the crystal form of potassium alum."

Relative rates of diffusion were determined by placing saturated alum solutions containing the dyes in test tubes fitted with rubber stoppers carrying glass tubes 3 mm. in diameter and 20 cms. long. These tubes were sealed off at one end, filled with saturated alum solution and immersed open end down in the dye alum solutions in the test tubes. The progress of the diffusion was observed by the upward movement of the color boundary in the tubes. Potassium permanganate was used as a standard for molecular dispersion. After standing two days in a quiet dark place the potassium permanganate, methyl violet, naphthol yellow and methylene blue had diffused to the tops of the tubes. Since 20 cms. diffusion in 48 hours seemed excessively high, the experiments were repeated by Mr. A. H. Burkholder<sup>1</sup> in this laboratory.

The first results obtained were unsatisfactory due to the fact that small crystals formed in the tubes, when the temperature of the room dropped slightly. When these became detached from the walls they fell through the tube and stirred up the solution in the test tubes. The difficulty was avoided by saturating the pure alum solutions, placed in the small tubes, about 2 degrees below room temperature. This resulted in a concentration difference which accelerated the diffusion velocity, however, under these conditions the stirring effect was eliminated and the maximum diffusion observed in five weeks was but 15 cms. Diffusion constants were calculated and found to be 19, 22, 12, 4 and 18 for naphthol yellow, methylene blue, quinoline yellow, diamine sky blue, and Bismarck brown respectively. The use of these constants as a criterion for molecular dispersion would lead one to conclude that both Bismarck brown and naphthol yellow are similarly dispersed, a conclusion not reached by Saylor. Diamine sky blue has a molecular weight about three times that of either naphthol yellow or Bismarck brown and its diffusion velocity would therefore be expected to be less than that of the other two dyes.

If Saylor's generalization is correct then one would expect that all basic dyes forming readily adsorbed cations would produce the same habit in the same crystalline substance. This is not the case when lead nitrate is grown in the presence of the basic dyes Bismarck brown and methylene blue. Both are adsorbed but the former produces octahedra and the latter cubes.

From these considerations it would appear that no simple rule has yet been found that enables one to predict just what foreign materials will be adsorbed by any one crystalline substance. However the results obtained thus far in this laboratory seem to warrant the conclusion that if a foreign substance is going to be adsorbed by a given crystal, the adsorption, resulting in a modification of the crystal habit, will occur at those crystal planes having the stronger fields of force. Such planes will in general be populated

<sup>1</sup> M. S. Dissertation, O.S.U., "Adsorption at Crystal Solution Interfaces," A. H. Burkholder, June 1929.

by ions of like charge rather than by mixtures of like and unlike. In general those substances containing polar groups will be more readily adsorbed than non-polar compounds.

#### Summary

1. Growth ratios have been determined for (a) ammonium alum in the presence of two dyes; (b) pure ammonium alum when grown from cubic seed crystals.

2. The effect of eighteen dyes and thirty-nine simpler organic compounds upon the crystal habit of ammonium alum has been determined.

3. The effect of certain dyes upon the crystal habit of ammonium, potassium and cesium alums has been compared.

4. The state of dispersion of dyes in water and in alum solution has been investigated by the use of the ultramicroscope and the ultrafilter.

5. The sign of the charge of the colloidal particles in dye-water solutions has been determined.

6. The possibility of the dye being adsorbed as a monomolecular layer has been considered, and an approximate determination of the thickness of the layer has been made.

7. Interfacial angles of an ammonium alum crystal on which dye was adsorbed have been measured.

*The Chemical Laboratories of  
The Ohio State University.*

## COMPARATIVE INFLUENCE OF SUNLIGHT, IRON PREPARATIONS AND VITAMINS IN THE MAINTENANCE OF HEALTH

BY C. C. PALIT, R. K. KAUL AND N. R. DHAR

It is well known that substances like sugar, starch, fats and proteins do not oxidise in air at the ordinary temperature but they are readily oxidised at the body temperature inside the animal body. In previous communications<sup>1</sup> from these laboratories, we have tried to explain the mechanism of the oxidation in the animal body and we have imitated these oxidation reactions. We have proved that the food materials can be oxidised by passing air at the ordinary temperature when they are mixed with reducing agents like sodium sulphite, ferrous hydroxide, cerous hydroxide, manganous hydroxide etc. It is well known that there are certain reducing agents in the animal body and these reducing agents when oxidised by atmospheric oxygen inside the body, are likely to induce the oxidation of food materials. Moreover, these food materials have been oxidised by us by passing air at the ordinary temperature in presence of sunlight. Also all these substances have been oxidised by hydrogen peroxide in presence of ferrous or ferric salts at a temperature of about 40°C.

Having induced the oxidation of food materials by passing air in presence of sunlight, we have carried on experiments on the metabolism in animals in presence and in absence of sunlight. We have also compared the influence of sunlight with that of substances containing vitamins and iron preparations on animal metabolism.

We have carried on experiments with pigeons and white rats. We divided the pigeons and rats among six compartments, each containing four pigeons and four rats respectively. The first compartment had sufficient amount of sunlight for about six hours, the second, fourth, fifth and the sixth ones had diffused light, while the third one was quite dark. The arrangements were the same in the case of the rats. All the six sets—pigeons and rats—were given polished (Rangoon) rice—which is known as being entirely devoid of vitamins—as food. The first and the third sets were given only rice, the second set was given 25 grms of 'palak' (*spinacia oleracea*) juice and 10 grms of 'palak' leaf, the fifth set was given 25 grms of 'bathua' (*chenopodium album*) juice and 10 grms of 'bathua' leaf and the sixth set was given 25 grms of tomato together with the same amount of rice in each case. The fourth set was given 25 c.c. of colloidal ferric hydroxide (25 c.c. = 0.002 gm. of Fe per 4 pigeons or 4 rats) or 25 c.c. of very dilute solution of ferric chloride (25 c.c. = 0.00086 gm. Fe per 4 pigeons or 4 rats) together with the same amount of rice. This diet was continued for three weeks. For the first week, they were found to be quite well, though there were very slight decrease in their weights. During the second week, no remarkable change but decrease

<sup>1</sup> Palit and Dhar: *J. Phys. Chem.*, 29, 799 (1925); 30, 939 (1926).

in their weights was noticed, but at the end of this period, most of the pigeons in the third set had stomachic troubles. During the third week, the third set which was kept in the dark, and the fourth set which was given colloidal ferric hydroxide, were found to be ill which turned serious day by day. Moreover it was found that all those that were ill had stomachic troubles and had their eyes greatly affected. All of them practically lost their moving power and showed symptoms of polyneuritis and beri-beri. At the end of the third week, the pigeons fed with 'palak,' (*spinacia oleracea*) 'bathua' (*chenopodium album*) and tomato were affected one after the other and became ill. The third set which was kept in the dark was found to be most affected. The order in which they were affected was the following:—

Set No. III > set No. IV > set No. II > set No. V > set No. VI, while the set No. I was not ill at all, though there was a considerable decrease in their weights. The diet was at once changed and the rice was discontinued. Those that were seriously affected and practically lost their eye-sight and moving power, were given milk, tomato juice, whole wheat and other substances rich in vitamins for the first two days, after which when they improved a little, were given a small quantity of "bajra," (*Pennisetum typhoideum*) and gram along with other substances. All the rest were given "bajra", (*Pennisetum typhoideum*) and gram. Those that were seriously affected and could not take their food, were separated from the rest and exposed to sunlight daily for three to four hours and were fed artificially with milk and tomato juice. Within a week the symptoms of beri-beri and polyneuritis disappeared and had their stomachic troubles removed. All of them were found to gain in weight and ultimately recovered perfectly. The first set which had sufficient amount of sunlight, though rendered weak, did not show any sign of beri-beri or polyneuritis at all. The second, fifth and sixth sets which were given 'palak', 'bathua' and tomato, were not as much affected as the third and the fourth sets, though they were not exposed to sunlight. It was also found that iron preparations given in very small doses ( $\text{Fe} = 0.00086$  grm. for 4 pigeons per day) is beneficial whereas in larger doses ( $\text{Fe} = 0.002$  grm. for 4 pigeons per day) become harmful. These iron preparations appeared to have more favourable action on rats than on pigeons. All these experiments were repeated and the same results were obtained showing that the results are reproducible. With the rats exactly similar results were obtained as in the case of the pigeons. When these birds and rats are fed on polished rice and kept in diffused daylight, they also develop the same troubles as described before.

Our results show that the animals receiving sunlight and no substances containing vitamin A, B or C and fed on polished (Rangoon) rice, kept good health for about three weeks whilst the same number of animals—pigeons and rats—getting the same food but no sunlight, developed stomachic troubles after a fortnight and acute form of polyneuritis and paralysis and their eyes were highly affected. Our experiments show that the addition of leafy vegetables like 'palak' (*spinacia oleracea*), 'bathua' (*chenopodium album*) etc. to polished rice have beneficial effect but their influence is less than that

of sunlight. Tomatoes and small doses of ferric chloride (25 c.c. = 0.00086 gm of Fe for 4 pigeons or 4 rats per day) are also beneficial. In slightly larger doses (25 c.c. = 0.002 gm of Fe for 4 pigeons or 4 rats per day) is not helpful as is quite evident from our experiments.

From our results we conclude that sunlight is more efficacious than leafy vegetables and tomatoes, when the animals are fed with polished (Rangoon) rice. In previous papers,<sup>1</sup> we have suggested that vitamin A acts as promoters in the oxidation of fatty food materials and vitamin B as promoter in that oxidation of carbohydrates. From our experiments it seems likely that sunlight acts as an accelerator of all kinds of food materials and can replace at least for a limited period vitamin A and B. It is, therefore, evident that in poor tropical countries like India and China, where the quality of food materials is unsatisfactory and also insufficient from the vitamin point of view, deficiency diseases would have been more prevalent, had not the compensating agent, the sunlight, been present. We are convinced that in tropical countries, the metabolism in the animal body is helped by sunlight and hence several diseases are avoided. McCollum and Simmonds (The Newer Knowledge of Nutrition—3rd Edition 1925 page 512) have advanced the view that leafy vegetables (*sak*) have been the protective food of the Indians, because they contain vitamin A. We are of opinion that the beneficial effect of the leafy vegetables is not due mainly to the vitamin content but is also due to their iron content. We have repeatedly shown that iron is a marked accelerator in the oxidation of the food materials. We have carried on systematic analysis of the iron content of many leafy and other vegetables and the results are as follows:—

Name of substance taken for analysis	Amount of ash taken in gm.	Percentage amount of iron found
Palak ( <i>Spinacia oleracea</i> )	1.1256	1.69
Bathua ( <i>Cenopodium album</i> )	0.7754	1.13
Methi ( <i>Trigonella Foenum-Græcum</i> )	1.5278	1.92
Tomato	0.5480	1.45

From our researches, it will be seen that polyneuritis and beri-beri can be avoided by sunlight and hence the following statement of Mayer<sup>2</sup> is erroneous:—

“Deficiency diseases which may be counteracted by vitamins are specially prevalent in the tropics and seem not affected by ultra-violet light, e.g. beri-beri and scurvy. Experiments with vitamins other than antirachitic and deficiency diseases other than rickets seem to have met with no success”.

<sup>1</sup> *Chemie der Zelle und Gewebe*, 12, 217, 225, 317 (1925); 13, 209 (1926).

<sup>2</sup> “Clinical Application of Sunlight and Artificial Radiation,” 70 (1926).

Recently Campbell<sup>1</sup> has found no effect of radiation from a mercury vapour lamp on the metabolism of men, rats and mice. Our results are not in agreement with Campbell's observations.

We have proved that food materials can be oxidised in presence of sunlight by passing air at the ordinary temperature. We have also been able to oxidise cholesterol in presence of light at the ordinary temperature. These results are interesting in view of the recent observations of different workers who have stated that inert food materials irradiated with the quartz mercury vapour lamp may be endowed with antirachitic qualities. It seems likely that these food materials when exposed to light take up oxygen from air and form a compound of the peroxide type which can oxidise any other food materials when mixed with it. Consequently the addition of the exposed substances to ordinary food materials facilitates the proper assimilation of ingested food stuff and hence we observe the efficacious results. The number of food materials that can be made antirachitic by simply exposing them to light is far from being limited. Steenbock and Daniels state that it is a property quite common to food of both plant and vegetable origin. We are of opinion that these substances on exposure to light take up oxygen directly and become converted into peroxides which can oxidise the foods taken into the system.

We have found that when a stream of oxygen is passed through a solution of olive oil in benzene or cholesterol in alcohol in presence of sunlight for two hours, an appreciable amount of the substance of the peroxide type is formed in both the cases, but the peroxide compound formed in the case of olive oil is much greater than that formed with cholesterol. These substances—peroxide type—when acidified with dilute sulphuric acid, decolourise potassium permanganate very quickly and then the pink colour of the permanganate slowly disappears and takes up more permanganate little by little. This very phenomenon was also observed in the case of the oxidation of potassium oxalate and sodium nitrite and has already been mentioned in one of our previous publications.<sup>2</sup> They also liberate iodine from potassium iodide and when compared colorimetrically, it was observed that the amount of iodine liberated from olive oil was much greater than that liberated from cholesterol. We have further observed that olive oil can be retained in that activated or excited state for a sufficient length of time if kept in the dark, but this phenomenon was not observed in a marked degree in the case of cholesterol, as it was found to have lost its active state in the course of a few days. Hence these facts corroborate our previous statements regarding the oxidation of food materials in the animal body.

In this connection, it will be interesting to note that E. Baur and C. Neuweiler<sup>3</sup> obtained hydrogen peroxide in aqueous suspensions of zinc oxide exposed to sunlight.

<sup>1</sup> Proc. Roy. Soc., 99B, 451 (1926).

<sup>2</sup> J. Phys. Chem., 3A, 939 (1926).

<sup>3</sup> Helv. Chim. Acta, 10, 90 (1927).



When the pigeons were affected, we took some photographs, which are shown below:—



**PLATE NO. 1<sup>1</sup>**  
 From set No. II (Palak and Rangoon rice)—just attacked with polyneuritis showing that the legs are affected.  
<sup>1</sup> Reference Plates I and II.  
 (1) J. Phys. Chem., 30, 939 (1926).  
 (2) Helv. Chim. Acta, 10, 90 (1927).



**PLATE NO. 4**  
 From set No. III (dark and Rangoon rice)—seriously affected showing the acute form of the disease.



**PLATE NO. 2<sup>1</sup>**  
 Same pigeon as in Plate No. 1—showing the acute form of the disease after 24 hours.  
<sup>1</sup> See Plate No. 1.



**PLATE NO. 5**  
 Same as Plate No. 4 showing still more acute form of the disease.



**PLATE NO. 3**  
 From set No. III (dark and Rangoon rice)—just attacked with disease showing that the legs and the eyes are affected.



**PLATE NO. 6**  
 (a) Black pigeon on the left—From set No. VI (Tomato and Rangoon rice):—just attacked with disease showing that the legs are affected.  
 (b) White pigeon on the right—From set No. II (Palak and Rangoon rice): shows the slight attack with disease.

**PLATE NO. 7**  
 From set No. VI (Tomato and Rangoon rice) seriously affected and almost on the point of death showing the acute form of the disease.  
 All these pigeons have been completely cured and are now enjoying good health.



### Summary

- 1). Experiments on pigeons and rats show that they do not get polyneuritis when fed on Rangoon rice alone provided they get some sunshine.
- 2). Leafy vegetables like Palak, Bathua, etc. and tomatoes when mixed with polished rice appear less effective than sunlight in the prevention of polyneuritis and eye troubles. Colloidal ferric hydroxide and ferric chloride in very small doses are as effective as the above vegetables.
- 3). Analysis shows that common leafy vegetables contain iron and hence the usefulness of leafy vegetables in the prevention of deficiency diseases is not only due to the presence of vitamins in them but is also due to their iron contents.
- 4). In tropical countries many deficiency diseases are avoided due to sunlight.
- 5). When substances like cholesterol, olive oil etc. are exposed to light in presence of air, peroxides are formed and these induce the oxidation of food materials mixed with them. Hence the antirachitic and beneficial properties of substances when exposed to light and not containing the necessary vitamins, are due to the presence of peroxides, which help the oxidation of food materials in the animal body. The substances can acquire anti-rachitic properties when exposed to light only in presence of air or oxygen.

*Chemical Laboratory,  
University of Allahabad, India.  
July 2, 1928.*

## THE VAPOR PRESSURE OF SOME STANNANES

BY RALPH H. BULLARD AND ALFRED C. HAUSSMANN

The vapor pressure of tetramethylstannane,  $(\text{CH}_3)_4\text{Sn}$ , trimethylethylstannane,  $(\text{CH}_3)_3(\text{C}_2\text{H}_5)\text{Sn}$ , and trimethyl-n-propylstannane,  $(\text{CH}_3)_3(\text{C}_3\text{H}_7)\text{Sn}$ , were measured in order to extend our knowledge of this class of substances.

### Materials

The tetramethylstannane for this research was supplied by Dr. C. A. Kraus of Brown University. It was treated with dry ammonia gas to remove any halides<sup>1</sup> and then fractionally distilled several times. Finally the portion boiling at  $77.5\text{--}78.0^\circ$  (uncorr) was used for the measurements.

The trimethylethylstannane was prepared by treating sodium trimethylstannide in liquid ammonia with ethyl iodide.<sup>2</sup> It was then fractionally distilled several times and the middle portion boiling at  $107.0\text{--}107.5^\circ$  (uncorr) was used for the measurements.

The trimethyl-n-propylstannane was prepared and purified by the same method, and the portion boiling at  $129.0\text{--}129.5^\circ$  (uncorr) was taken for the measurements.

### Apparatus

The apparatus employed was essentially that recommended by Smith and Menzies<sup>3</sup> except that the system was entirely of glass with no rubber connections. The confining liquid in the U-tube of the isoteniscope was the substance being measured. The thermostat was a well-insulated square metal tank of about sixty liters capacity, provided with a Cenco centrifugal stirrer, Cenco knife-type heaters and a thermoregulator operating through a relay. The temperature could be maintained constant within  $0.01^\circ\text{C}$ . For measurements up to  $55^\circ\text{C}$  water was used in the thermostat; above  $55^\circ$  a colorless transparent mineral oil was used. The manometer was of the ordinary closed end type accurate to within  $0.2$  mm. Temperatures were measured by means of a copper-constantan thermocouple which had previously been calibrated by the Bureau of Standards. A Leeds and Northrup Type K potentiometer and a Leeds and Northrup Type R galvanometer were used to read the electromotive force. Temperature measurements were accurate to within  $0.05^\circ\text{C}$ . For evacuating the system a mercury vapor pump backed by a Cenco Hyvac pump was used.

<sup>1</sup> Werner and Pfeiffer: *Z. anorg. Chem.*, 17, 82 (1898).

<sup>2</sup> Bullard and Vinge: *J. Am. Chem. Soc.*, 51, 892 (1929).

<sup>3</sup> Smith and Menzies: *J. Am. Chem. Soc.*, 32, 1419 (1910).

### Procedure

The isoteniscope and a tube containing the stannane, fitted with a glass stopcock, were sealed into the vacuum line. The system was then evacuated until it showed a pressure of less than 0.001 mm on the McLeod gauge. The stopcock to the tube containing the stannane was then opened and by immersing the bulb of the isoteniscope in ice water the stannane distilled into it. Some stannane was then distilled into the U-tube of isoteniscope. The stopcock directly above the isoteniscope was then closed. The isoteniscope was then sealed to the manometer. The system, down to the isoteniscope, was evacuated until it showed a pressure of less than 0.001 mm. The stopcock above the isoteniscope was then opened to the manometer and pump. The bulb of the isoteniscope was warmed and some of the stannane was allowed to boil through the confining stannane in the U-tube, thus removing any dissolved gases. The usual procedure for determining vapor pressures was then followed. For adjusting the levels in the U-tube air was admitted cautiously through a well-lubricated glass stopcock or taken out by the vacuum pump by carefully turning another well-lubricated glass stopcock. Two independent series of determinations were made on each stannane over the entire temperature range.

### Experimental Data

The observed temperatures and vapor pressures are given in Table I. In all cases the pressures have been corrected and are expressed in terms of millimeters of mercury at 0°C.

TABLE I  
Observed Temperatures and Vapor Pressures

$(\text{CH}_3)_4\text{Sn}$		$(\text{CH}_3)_3\text{C}_2\text{H}_5\text{Sn}$		$(\text{CH}_3)_2\text{C}_2\text{H}_7\text{Sn}$	
Temp °C	Vapor Press	Temp °C	Vapor Press	Temp °C	Vapor Press
0.1	31.4	0.1	8.2	13.5	6.0
1.3	33.4	0.9	8.5	18.5	8.3
2.9	36.5	5.0	10.9	21.1	9.3
5.8	42.6	8.6	13.5	24.6	11.9
7.5	46.2	10.6	15.0	27.0	13.6
8.9	50.0	11.9	15.9	29.1	15.2
11.2	55.7	12.7	17.1	31.3	17.3
12.0	58.5	13.7	17.8	33.4	19.0
14.1	64.6	16.2	20.2	34.7	20.4
14.3	65.4	17.5	21.6	36.1	22.0
16.0	71.1	19.2	24.2	38.3	24.7
18.3	79.2	23.6	30.0	41.1	28.3
22.1	95.1	26.1	33.6	44.3	32.9
25.6	111.2	27.4	35.7	47.8	39.3
26.8	117.3	29.1	39.0	50.3	43.5
28.1	124.2	30.8	42.6	52.1	48.5

TABLE I (continued)

$(\text{CH}_3)_4\text{Sn}$		$(\text{CH}_3)_2\text{C}_2\text{H}_5\text{Sn}$		$(\text{CH}_3)_2\text{C}_3\text{H}_7\text{Sn}$	
Temp °C	Vapor Press	Temp °C	Vapor Press	Temp °C	Vapor Press
29.8	133.6	33.5	48.6	53.8	51.9
32.4	148.8	35.8	53.9	55.0	55.1
33.7	157.0	38.7	61.7	56.0	57.4
34.9	165.3	40.2	66.2	56.6	59.1
37.1	181.3	41.5	70.9	57.3	60.2
39.1	195.9	44.6	80.8	58.0	62.8
39.3	197.3	46.4	86.9	59.5	67.5
40.5	208.7	48.0	94.1	63.7	80.4
41.8	217.9	50.4	103.6	64.4	82.3
43.0	229.2	52.3	111.9	67.0	92.5
44.3	240.6	52.9	114.8	70.2	104.5
45.3	250.7	56.0	131.1	72.5	114.6
47.4	268.6	57.1	137.4	77.0	135.9
50.1	300.8	58.8	145.9	80.8	156.8
53.4	336.3	60.7	157.7	82.5	166.2
54.3	350.4	62.3	167.0	84.3	178.4
57.8	396.5	62.3	167.2	87.7	201.2
59.9	425.5	63.4	175.8	88.7	207.7
60.1	429.8	64.7	185.0	90.3	220.2
61.7	450.8	66.2	193.6	93.5	245.6
63.4	479.5	67.8	207.0	97.0	276.7
65.7	516.3	69.7	220.7	98.5	289.1
66.4	525.6	70.9	231.5	100.5	308.7
67.7	550.4	73.8	256.3	103.1	337.3
70.2	594.9	75.2	269.7	106.2	372.7
72.3	637.0	76.1	277.4	106.7	377.7
73.3	653.6	78.8	306.5	109.0	404.4
75.0	691.6	81.6	335.6	112.1	444.6
75.2	694.6	82.8	346.8	116.1	502.5
75.6	706.2	84.4	368.3	119.0	544.9
76.1	716.1	87.6	409.8	121.5	582.5
77.2	740.6	88.9	424.1	122.0	590.4
77.8	753.5	90.1	443.8	125.3	653.6
79.1	784.2	92.9	485.0	127.9	702.6
79.7	794.8	94.4	506.8	129.1	724.5
80.2	809.9	96.2	535.5	130.1	744.4
		98.8	577.3	132.0	786.5
		101.5	626.0		
		103.2	655.9		
		105.9	713.6		
		106.9	731.9		
		109.4	787.6		
		110.5	809.6		

In Fig. 1 are shown the curves obtained by plotting the logarithm of the pressure against the reciprocal of the absolute temperature.

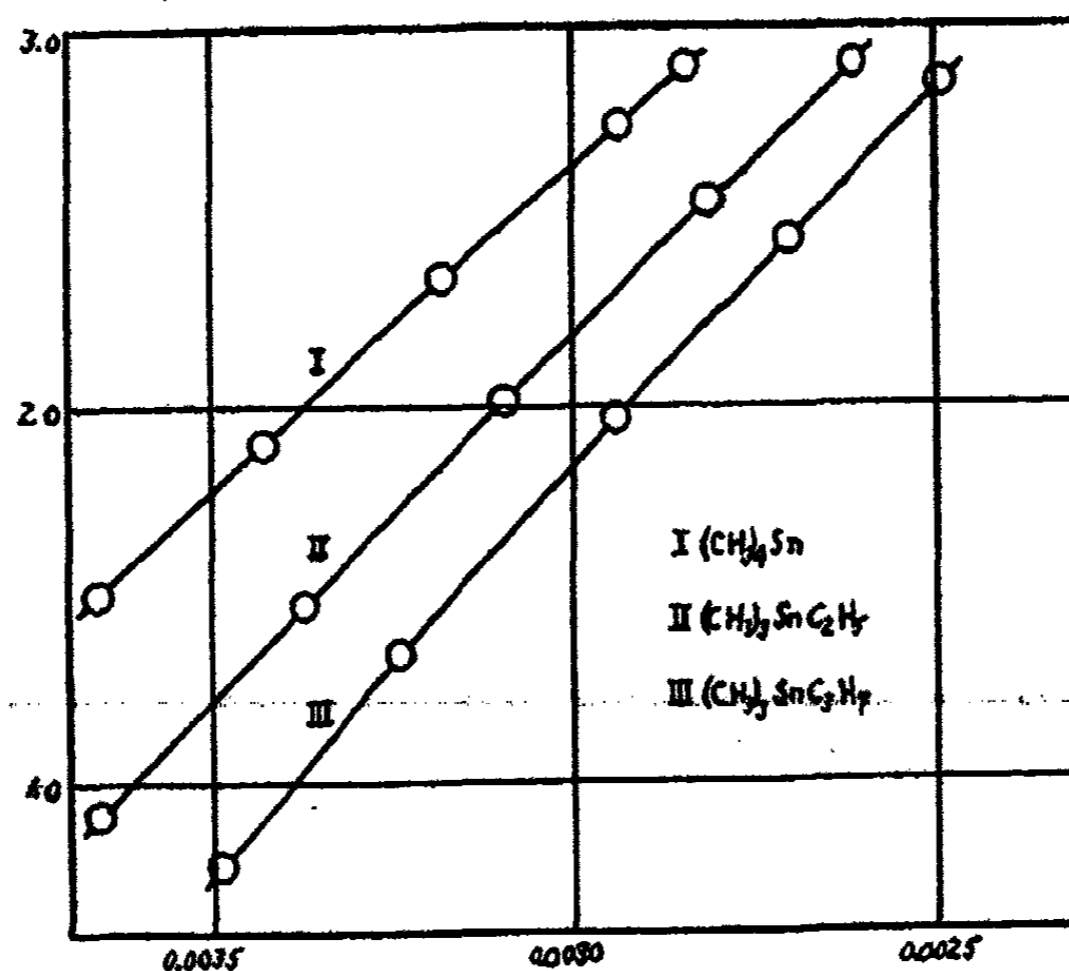

FIG. 1  
Log<sub>10</sub>P plotted against 1/T (abs.)

#### Discussion of Results

By use of the Method of Moments the constants in the equation  $\log_{10}P = B - A/T$  have been calculated for the compounds measured. The values of the constants A and B are given in Table II.

TABLE II  
Values of the constants A and B in the equation  $\log_{10}P = B - A/T$ .

		A	B
(CH <sub>3</sub> ) <sub>4</sub> Sn	from 0° to 35°	1747.8	7.8955
	from 35° to 80°	1648.0	7.5747
(CH <sub>3</sub> ) <sub>3</sub> (C <sub>2</sub> H <sub>5</sub> )Sn	from 0° to 63°	1934.3	7.9937
	from 63° to 111°	1822.7	7.6630
(CH <sub>3</sub> ) <sub>3</sub> (C <sub>3</sub> H <sub>7</sub> )Sn	from 13° to 55°	2164.0	8.3381
	from 55° to 132°	1990.3	7.8142

The boiling points of these substances were determined from the curves in Fig. 1 as that temperature corresponding to a pressure of 760 mm. They were found to be for (CH<sub>3</sub>)<sub>4</sub>Sn, (CH<sub>3</sub>)<sub>3</sub>(C<sub>2</sub>H<sub>5</sub>)Sn, and (CH<sub>3</sub>)<sub>3</sub>(C<sub>3</sub>H<sub>7</sub>)Sn, 78.0°C, 108.2°C, and 130.8°C respectively.

From the equation  $2.303 R \frac{d \log_{10} P}{d 1/T} = \Delta H$ , the molal heats of vaporization at the boiling points were calculated. The values of the tangents at the boiling points were obtained from the curves in Fig. 1. The molal heats of vaporization at their boiling points of  $(\text{CH}_3)_4\text{Sn}$ ,  $(\text{CH}_3)_3(\text{C}_2\text{H}_5)\text{Sn}$  and  $(\text{CH}_3)_3(\text{C}_3\text{H}_7)\text{Sn}$  are 7406, 8338, and 8913 respectively.

On substituting these quantities in the Trouton equation the molal entropies are found to be 21.0, 21.9 and 22.1 respectively, indicating that these are normal or non-polar liquids.

#### Summary

Vapor pressure measurements have been made on tetramethylstannane, from  $0^\circ\text{C}$  to  $80^\circ\text{C}$ , on trimethylethylstannane from  $0^\circ\text{C}$  to  $111^\circ\text{C}$ , and on trimethyl-n-propylstannane from  $13^\circ\text{C}$  to  $132^\circ\text{C}$ .

From these results the boiling points and molal heats of vaporization have been determined.

The molal entropies indicate that these are normal liquids.

The authors wish to acknowledge their indebtedness to the Warren Fund of the American Academy of Arts and Sciences for a grant which assisted in defraying the expenses of this investigation.

*Hobart College,  
Geneva, N. Y.*

## PLATINUM BLACK CATALYSTS

### I. Physical Properties and Catalytic Activity\*

BY GUY B. TAYLOR, GEORGE B. KISTIAKOWSKY AND JOHN H. PERRY

#### Introduction

Platinum is among the oldest known contact catalytic agents. It is widely used for a variety of chemical reactions both in the plant and laboratory. The present investigation is an attempt to correlate the catalytic activity of three samples of platinum black prepared by different methods with other properties of the preparations such as particle size and adsorptive characteristics. In these studies several members of the staff of this laboratory have participated. Part I is concerned with physical properties and catalytic activity. Part II, to follow, is a study of heats of adsorption.

#### *Preparation of Samples*

No. 1 was prepared by heating precipitated ammonium chloroplatinate in a stream of hydrogen at 200°C. followed by a stream of nitrogen at 250-300°C. for 24 hours. The sample contained a little ammonium chloride.

No. 2 was prepared by pouring an aqueous solution of platinum chloride and formaldehyde into boiling sodium hydroxide solution. The precipitated platinum was washed with dilute hydrochloric acid followed by hot and cold water for several days. Sodium could still be detected spectroscopically.

No. 3 was prepared by reducing platinum chloride solution with hot hydrazine hydrate solution and washing the precipitate free of the chloride ion.

#### *Structure of Samples*

The X-ray diffraction patterns of the three samples were obtained by the standard procedure with the General Electric Multiple X-ray Diffraction Apparatus, which uses filtered molybdenum radiation. The lines in all cases corresponded to pure platinum. The pattern of sample No. 1 was characterized by clear, sharp lines extending the entire length of the film. Nos. 2 and 3 gave patterns with broad, diffuse lines which faded out for the larger angles of diffraction. These differences indicate that the crystallites in No. 1 were considerably larger than those in the other two samples. They were, in fact, outside the range of measurement by the X-ray method, i.e., larger than  $10^{-5}$ cm. Nos. 2 and 3 could not be differentiated by X-ray methods, and their crystallites, as calculated by the Debye-Scherrer formula for line breadths, were of the order of 30 A.U. The X-ray photographs are shown in Fig. 1.

\* Contribution No. 22 from the Experimental Station of E. I. du Pont de Nemours and Company.



Particle size was measured by the microscopic method. Photo-micrographs show the mean diameter of the particles of Nos. 1 and 3 to be  $10^{-4}$  cm. The range in size of No. 1 was 0.4 to  $4 \times 10^{-4}$  cm. The particles of No. 2 were smaller, ranging between 0.15 and  $0.7 \times 10^{-4}$  cm. and averaging  $0.37 \times 10^{-4}$  cm.

By the method of dispersion in castor oil and measurement of the sedimentation rate,<sup>1</sup> Nos. 1 and 3 were obviously much coarser than No. 2 and settled out fairly rapidly under gravity even in so viscous a medium as castor oil. The particle size averaged  $3 \times 10^{-4}$  cm. Sample No. 2 was better adapted to sedimentation methods. Its light-obscuring power when dispersed in castor oil was twenty times that of No. 1. This sample was analyzed in the ultracentrifuge; the range in particle size was estimated to be 0.08 to  $1.2 \times 10^{-4}$  cm., with a "mean value" of  $0.3 \times 10^{-4}$  cm.

The discrepancies arise, in part, because different quantities are measured in the different methods. In photomicrographs obvious aggregates were not

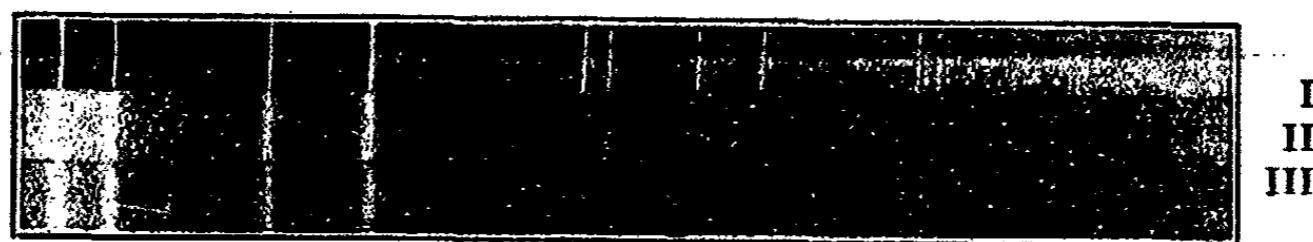

FIG. 1

X-Ray Powder Pictures of Platinum Blacks. Taken on General Electric Multiple Diffraction Apparatus.

counted, and in sample No. 2 many of the particles were below the resolving power of the microscope. The sedimentation method on the other hand includes all the particles, aggregates as well as submicroscopic particles. There is one other difference. The microscopic method yields directly a value for the average size while the "mean value" of the sedimentation method is the size of those particles which, taken together, weigh the most. In general, the sedimentation value is about three times that obtained by microscopic count.

From the above described tests it was established that preparation No. 1 was a relatively coarse crystalline powder; No. 3 consisted largely of aggregates of submicroscopic crystallites; and in No. 2 not only were the crystallites exceedingly minute, but aggregation was much less than in the other two.

#### Catalytic Properties

The samples were tested as catalysts for several simple oxidation and reduction reactions of gases. From heats of adsorption measurements to be reported in Part II of this paper, G. B. Kistiakowsky predicted that the order of efficiency of the three samples would be 3, 2, 1 for reductions and 2, 3, 1 for oxidations. These orders were later actually established for the reactions studied.

<sup>1</sup> For method see Nichols and Liebe: Coll. Symposium Monograph, 3, 268 (1925).



Electrolytic gas equivalent to 15 mg.  $\text{H}_2\text{O}$  per 5 min. interval<sup>1</sup> was added to either 200 cc. hydrogen or 115 cc. oxygen flowing per minute over 0.2 g. of the samples, unheated. The efficiency of reaction was in every case 100% for catalysts Nos. 1 and 2. No. 3 was not tested.



Hydrogen containing 3% nitric oxide was passed over 0.5g. platinum. At rates of 200 cc. per minute the conversions to  $\text{NH}_3$  without heating the catalysts were high. Addition of carbon monoxide, 2 to 3%, definitely poisoned the reduction at temperatures up to 285°, but not 400° (tests with No. 3). The carbon monoxide was not changed to methane by platinum under any conditions. A nickel catalyst in the same apparatus was not poisoned by carbon monoxide whether the temperature was high enough to convert carbon monoxide to methane or not.



This reaction was studied thoroughly with all three samples at 25°C., using a static method. Two grams of the sample were placed in a tube connected with a manometer. The platinum was first heated to 250°C. in hydrogen and then out-gassed. A mixture of ethylene and hydrogen was then admitted after cooling to 25°C., and the reaction followed by pressure change. Ratios of hydrogen to ethylene of 0.5, 1, and 2 were used. The results were reproducible and consistent but no kinetic reaction-order could be established. Table I for equimolar mixtures sufficiently fixes the order of activity as 3, 2, 1. The initial partial pressure of each gas was 335 mm.

TABLE I  
Hydrogenation of Ethylene

Time Minutes.	Pressure decrease in mm.		
	No. 1	No. 2	No. 3
0.5	50	85	93
1	60	93	101
3	100	125	131
5	117	140	146
10	162	180	185

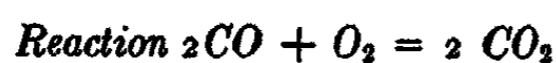

The apparatus consisted of a short Pyrex laboratory condenser supported vertically. The inside tube contained a plug of glass wool on which the catalyst was supported. Projecting 2 or 3 mm. through the plug from below was a narrow glass tube carrying a fine wire chromel-alumel thermocouple. Heating the catalyst was accomplished by boiling water or aniline in the condenser jacket. The effluent gases were analyzed volumetrically for carbon

<sup>1</sup> For general method see Pease and Taylor: *J. Am. Chem. Soc.*, **44**, 1637-47 (1922); or Larson and Smith: *ibid.*, **47**, 346-55 (1925).

dioxide with a Burrell-Haldane apparatus before and after passage over red-hot platinum gauze. In the following experiments (Table II) the oxygen flow was 110-120 cc. per minute.

TABLE II  
Oxidation of Carbon Monoxide

Catalyst No.	Wt. g.	Remarks	Heating Medium	T.C. °C. after cat.	% CO <sub>2</sub>	% CO <sub>2</sub> Total Combustion	
1	1.2	As made	Steam	92	0.00	2.75	
	1.2	" "	Aniline	180	2.10	2.10	
	0.2	Barely covered glass wool support	Steam	25	0.00	3.70	
2	1.0	Heated in air at 490° 24 hr.	None	65	3.40	3.30	
	1.0	" " " " " " "	"	62	2.80	2.85	
	0.1	" " " " " " "	"	35	0.15	3.15	
	0.1	" " " " " " "	Steam	150	2.55	2.45	
	1.95	" " " " 675° 1 hr.	None	25	0.00	3.50	
2	1.95	" " " " " " "	Steam	97	0.00	4.00	
	1.95	" " " " " " "	Aniline	190	4.00	4.00	
	0.2	" " " " " " "	"	190	2.55	2.85	
	3	1.2	As made	None	25	0.00	2.90
		1.2	" "	Steam	100	3.55	3.55
0.2		Barely covered glass wool support	None	—	0.00	3.60	
0.2		" " " " " " "	Steam	97	0.10	3.60	
0.2		" " " " " " "	Aniline	203	3.05	3.00	

From Table II it is evident that the order of activity is 2, 3, 1. The best criterion is the temperature at which quantitative conversion occurs. Sample No. 2 withstood a rather high temperature without becoming thermally inactivated.

TABLE III  
Conversion of SO<sub>2</sub> to SO<sub>3</sub>

	No. 1	No. 2	No. 3
Vol. catalyst cc. (0.976 g.)	0.75	1.2	1.2
Space velocity	36,000	22,000	22,000
Temp. max. conversion	445°	340°	412°
Maximum conversion	85%	98.5%	92%
Conversion at 300°	71%	98%	74%
" " 400°	83%	98%	91%
Tests after operation at	585°	545°	575°
Temp. max. conversion	500°	460°	500°
Maximum conversion	75%	85%	82%
Conversion at 300°	0%	69%	0%
" " 400°	61%	84%	66%

*Reaction*  $2 SO_2 + O_2 = 2 SO_3$ .

A mixture of air and sulfur dioxide, 8% by volume, was passed through the catalysts at a rate of 450 cc. per minute. The samples were contained in a glass tube heated in an electric resistance furnace. Temperatures were measured by a thermocouple in a small glass tube, the tip of which rested against the catalyst on the upstream side. Conversion efficiencies were determined by analysis of the exit gases by a modified Reich test.

After operation at about 200°C. for several hours, a series of conversion tests at increasing temperatures were made and curves constructed of conversion vs. temperature. Operation was then continued for several hours at a temperature above 540°C., the temperature lowered, and a second series of tests made. The results are given in Table III.

It is quite clear from the data that the order of activity is 2, 3, 1. Just as in the oxidation of carbon monoxide, No. 2 was remarkable in resisting thermal deactivation.

#### Summary

Particle size and catalytic activity have been measured for three samples of platinum black prepared by different methods. The two samples showing the smaller ultimate particle size show the greater catalytic activity. One of these is superior in oxidation reactions and the other is slightly better for hydrogenation. Further discussion is reserved for Part II.

Acknowledgments are made to A. W. Kenney and G. H. Cameron for the X-ray studies, to H. B. DeVore for photomicrographs, to J. B. Nichols for sedimentation measurements and to P. W. Bachman and W. T. Harvey for some of the catalytic measurements.

## PHASE RULE STUDIES ON THE PROTEINS. II\* .

BY

WILDER D. BANCROFT AND C. E. BARNETT

### Pentavalent Nitrogen in Organic Compounds. I

Dr. P. A. Levene of the Rockefeller Institute was good enough to present us from his stock with samples of glycyl glycine, N-methyl-alanyl-glycyl glycine and glycyl-glycyl glycine, the simplest of the polypeptides, for which we are very grateful. Mr. M. O. Baker of this laboratory has made for us some glycyl-phenylalanine. Our thanks are given to Professor John R. Johnson for this sample. With the exception of glycyl-glycyl glycine, in all the cases, as well as with glycine itself, the simplest amino acid, all the nitrogens combine stoichiometrically with hydrogen chloride. From the curves for glycyl glycine, N-methyl-alanyl-glycyl glycine, glycyl-glycyl glycine, and glycyl-phenylalanine, as shown in Fig. 1 there is no reason to

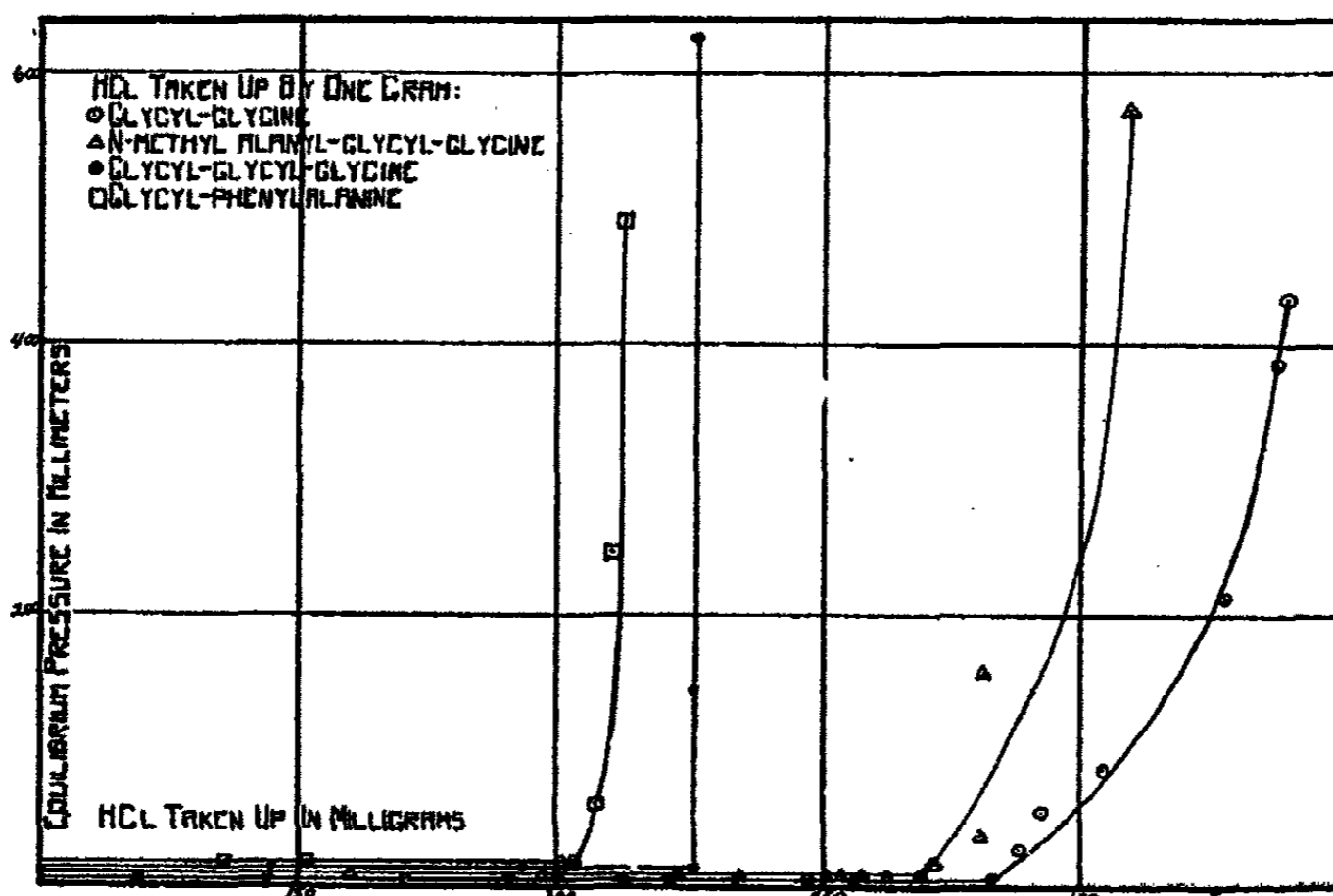

FIG. 1

suppose that a similar relation will not hold for higher polypeptides of the same type. On the other hand it has been found that with gliadin only about thirty percent in round numbers of the total nitrogen combines stoichiometrically with hydrogen chloride, with edestin only about twenty percent, and with zein none at all, at least within the present limits of accuracy.

\* This work is part of the programme now being carried out at Cornell University under a grant from the Heckscher Foundation for the Advancement of Research established by August Heckscher at Cornell University.

The discovery that glycyl-glycyl glycine reacted with only two equivalents of hydrogen chloride was a distinct disappointment, since there was no apparent reason for this abnormal behavior. It could be explained, however, if the solid tripeptide existed as the intramolecular salt



which hydrogen chloride could not displace. Some justification for this view is given by Emil Fischer.<sup>1</sup> "The results of the synthesis, and all known transformations, of the polypeptides are in harmony with the conclusion, that these compounds are still a kind of amino acid. . . . In spite of this simplification, the question of the structure and of the possibility of isomeric forms of the polypeptides remains complicated enough; for about one or another of them collected the disputed points, respecting which the structure of the amino acids and amines has remained unsettled. We have accordingly, on one side, to reckon with the possibility of lactam and lactim forms and on the other side with the antagonism between free amino acids and intramolecular salts. The following four formulas appear therefore for glycyl glycine:

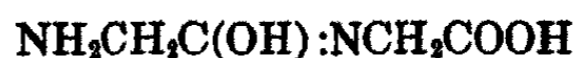

Since it is impossible from the observations submitted hitherto, to make a choice between them, for simplicity I have used only the first formula. I hold it, however, in no way useless, to be able, through a basic study of the polypeptides, to comprehend at a glance the above forms, whose number naturally increases with the size of the molecule. I have already made observations on some polypeptides which appear to point to different states. Leucyl-diglycyl glycine in the amorphous state is easily soluble in alcohol; if one heats this alcoholic liquid on a water bath, in a short time the crystalline tetrapeptide separates, which is very insoluble in alcohol."

On page 327 referring to glycyl-glycyl glycine, "the aqueous solution reacts neutral. . . . The tripeptide, relatively insoluble in cold water dissolves immediately on addition of hydrochloric acid. The hydrochloride is apparently easily soluble in fuming hydrochloric acid, crystallizing only at a higher concentration."

On page 352, "the tripeptide is very easily transformed by alcoholic hydrochloric acid into the ester, which separates as the very insoluble hydrochloride. If this is decomposed with silver oxide in cold aqueous solution, and the filtrate freed of silver by exact addition of hydrochloric acid, the liquid on evaporation in a vacuum leaves behind the diglycyl glycine ester as a crystalline solid easily soluble in water and reacting alkaline."

From these considerations it seems to us that we are dealing in glycyl-glycyl glycine with an intramolecular salt which prevents the addition of

<sup>1</sup> Emil Fischer: "Untersuchungen über Aminosäuren, Polypeptide und Proteine," 41 (1906).

hydrogen chloride on one of the nitrogen atoms, the nitrogen already being in the pentavalent state. The ester of glycyglycyl glycine would unquestionably add three equivalents of hydrogen chloride. A similar condition occurs with hippuric acid and will be taken up later. In glycine and glycyglycine the chain is too short to give an intramolecular salt which will resist the action of hydrogen chloride. This argument is strengthened by the fact that N-methyl-alanyl-glycyl glycine reacts with three equivalents of hydrogen chloride. In this case one hydrogen atom of the amino group has been replaced by methyl, thus eliminating the possibility of the formation of an intramolecular salt.

Somewhat similar results are reported for the alkaloids by Barger and Pyman.<sup>1</sup> "Most of the alkaloids are monacid bases even when they contain several atoms of nitrogen in the molecule. Thus, pilocarpine with two, physostigmine with three, and ergotoxine with five nitrogen atoms are monacid bases. Quinine is the best-known example of a di-acid alkaloid." Stating this in terms of percentages, one hundred percent of the nitrogen in quinine combines stoichiometrically with hydrogen chloride, fifty percent in pilocarpine, thirty-three percent in physostigmine, and twenty percent in ergotoxine.

Variations of the same sort occur in simpler substances where there is no doubt about the chemical constitution or the molecular weight. Hexamethylene tetramine has four nitrogen atoms in the molecule and all of them combine stoichiometrically with hydrogen chloride. Triamidotriphenyl amine has four nitrogens and takes up only three hydrogen chlorides stoichiometrically. Arginine has four atoms of nitrogen in the molecule and only two combine stoichiometrically with hydrogen chloride. In the case of aminoguanidine only one of the four nitrogen atoms reacts stoichiometrically and none of those in uric acid do. We can, therefore, have all stages from one hundred percent of the nitrogen reacting stoichiometrically with hydrogen chloride down to zero percent. If we had started with compounds having three nitrogen atoms in the molecule, it would have been equally easy to have cited cases in which three, two, one, or no hydrogen chlorides were taken up stoichiometrically.

In the cases where the constitution and molecular weight are known, it is easy to see that differences in the nitrogen linkages account for the differences in the amounts of hydrogen chloride reacting stoichiometrically. It seems only reasonable to conclude that similar factors play some part in the cases in which we do not know the molecular weight or constitution. If we could formulate a set of rules which would tell us with a fair degree of exactitude under what conditions nitrogen will become pentavalent at ordinary temperature, and in presence of hydrogen chloride at atmospheric pressure, it might be possible in particular cases to draw some conclusions as to linkages from the percentages of nitrogen which combines stoichiometrically with hydrogen chloride or other substances initially or after varying degrees of hydrolysis.

<sup>1</sup> Thorpe's "Dictionary of Applied Chemistry," 1, 140 (1921).

It would be very interesting if one could say, for instance, that there were no peptide linkages in zein within the limits of the present experimental error. Data of this sort should also give us some clue as to the peculiar action of pepsin on proteins and on the synthetic polypeptides.

An attempt was made by van't Hoff<sup>1</sup> over fifty years ago to formulate the conditions under which nitrogen becomes pentavalent; but some of the data, on which he relied, are now known to have been inaccurate, and consequently he missed some of the important points. Also there are now many more data on which to base a generalization than were available in 1877, when van't Hoff wrote the preface to his book. If one keeps this in mind, one cannot fail to be impressed by what van't Hoff did, though the seed fell on barren ground so far as the organic chemists were concerned. It is a great pleasure to us to call attention to this apparently forgotten record.

"The alkaline properties of the nitrogen compounds are all dependent on the action of the fourth and fifth valence of nitrogen. As one measure we may take the heats of neutralization. . . . The thermal data show that the hydrogen-rich methyl group behaves like hydrogen. In the absence of hydrogen and in the presence of chlorine or oxygen, the basic properties of the organic nitrogen compounds are modified.

"The interchangeability of methyl and hydrogen was discussed in Part I, p. 103. The effect of the other elements on the basic properties of the nitrogen compounds manifests itself in the simplest compounds and is therefore so obvious as only to need mentioning. The modification of the basic properties through absence of hydrogen can be seen by comparing ammonia with nitrogen itself. [This is not quite fair because there are two nitrogen atoms in the nitrogen molecule and only one in the ammonia molecule.] Only the ammonia adds on acids. A similar effect, when produced by substitution of chlorine or oxygen, shows itself in nitrogen trichloride and in the nitroxy compounds: the heat of neutralization of hydroxylamine is only 9.2 cal., and the basic character has disappeared completely in hyponitrous, nitrous, and nitric acids.

"By referring back to the simpler cases, we can account for what is observed in the more complicated ones. The interchangeability of methyl and hydrogen shows itself in the comparison of methyl-, dimethyl-, and trimethylamine with ammonia; also in the similarity between methylamine, ethylamine, and so on. In short the facts show that all the amines of the fatty acids come very close to ammonia in basic properties. [We now know that the replacement of hydrogen by methyl in ammonia increases the basic tendency somewhat.]

"The decrease of the alkalinity with the decrease in the hydrogen content shows itself in the increased hydrolysis of the salts by water or in the complete inability to combine with acids. The first occurs with hydrogen cyanide, the nitriles, and the carbylamines, which all contain four less hydrogen atoms than the corresponding amines of the fatty series, carbodi-imide, etc. The

<sup>1</sup> "Ansichten über die organische Chemie," II, 170 (1881).



second occurs with azobenzene, with diazobenzene imide, etc. It is important to notice that the effect of loss of hydrogen is greatest when the loss occurs in the immediate proximity of the nitrogen to be affected. In the case of aniline which has eight hydrogen atoms less than hexylamine, the heat of neutralization drops from at most 12.4 (the heat of neutralization of ammonia) to 7.4, a drop of only about 5. The hydrogen was not taken at all from the nitrogen, for then the effect is greater. The removal of two hydrogens from the nitrogen causes a further drop of at least 7.4, because azobenzene does not combine with acids at all. [This statement is generally believed; but it appears not to be accurate.] A similar result is observed if one compares the isomeric nitriles and carbylamines, for instance,  $\text{H}_3\text{C.C:N}$  and  $\text{H}_3\text{C.N:C}$ . In carbylamine the nitrogen is attached to the methyl group and consequently this compound is much more able to bind acids than the other.

"The above-mentioned decrease in alkalinity shows itself also in the addition of fewer molecules of acid than correspond to the nitrogen content. With the polyamines of the ethylene series the number of acid molecules which can be made to add on is exactly equal to the number of nitrogen atoms; but this figure decreases with substances containing less hydrogen. Thus, hexamethylene tetramine, the cyanamides, the amidines, the hydrazines, etc., combine each with only one molecule of hydrogen chloride. [This is known now not to be true for hexamethylene tetramine<sup>1</sup> and for the alkyl hydrazines.]

"The presence of substituted chlorine also decreases the alkalinity of organic nitrogen bases. In cyanogen chloride the power of prussic acid to bind hydrogen chloride has been lost. The chlorine-substituted amines ( $\text{CH}_3.\text{NCl}_2$ , etc.),

the amide chlorides, and the imide chlorides ( $\text{X.C} \begin{array}{l} \text{Cl} \\ \diagup \quad \diagdown \\ \text{NH}_2 \end{array}$  and  $\text{X.C} \begin{array}{l} \text{Cl} \\ \diagup \quad \diagdown \\ \text{NH} \end{array}$ )

will doubtless show the same thing.

"We can follow the same thing with oxygen more generally because there are more data available. If the oxygen in organic compounds is attached to the nitrogen itself, its effect is so strong that all tendency to combine with acids is lost. The nitro compounds, the nitroso compounds, the nitrolic acids, and the azoxy compounds do not combine at all with acids. When the oxygen is attached to the same carbon as the nitrogen, there is still a good deal of effect, but not so much as in the preceding cases. The amides combine with acids and so does cyanic acid; but the compounds are often decomposed by water. Only one molecule of hydrogen chloride is taken up by urea. When the oxygen is farther from the nitrogen, it still has an effect, as proved by the thermal data with regard to nitraniline and aniline. The effect is much less, and oxethylamine, for instance, is a strong base. . . .

"Very remarkable is the indirect action of the nitrogen on the acid character of hydrogen cyanide. The absence of hydrogen, which, as before men-

<sup>1</sup> Bancroft and Barnett: *J. Phys. Chem.*, 34, 449 (1930).

tioned, makes it possible for the group  $-C : CH$  to replace its hydrogen by metals is here increased by the presence of nitrogen. As for the extraordinary affinity of hydrogen cyanide for oxides of the heavy metals, we may mention that this is found both with substances having the group  $-C : CH$  and with the nitrogen compound ammonia.

"The nitrogen-containing nitro group also shows in its indirect action the closest agreement with oxygen, as appears from the following paragraph:—

"The nitro group makes it possible for adjacent hydrogen atoms to be replaced by metals, as in the case of nitromethane. As has been previously pointed out, the first metal atom that comes in checks this tendency, so only one of three otherwise identically bound hydrogen atoms is replaced. That the action of the nitro group decreases with the distance is shown by nitroethane and other substances which contain hydrogen on the nitrated carbon atom and elsewhere. Only the first is replaceable by metals. That this effect does not entirely disappear on other carbon atoms, but merely becomes too weak to cause this replacement is shown by the behavior of phenol which forms salts more readily after the introduction of a nitro group at some distance from the carbon which carries the hydroxyl. Also the alkalinity of aniline is decreased by the introduction of a nitro group."

Theoretically, the strength of the linkage between a nitrogen base and hydrogen chloride, as calculated from the dissociation pressure will vary with every change in the composition or the structure of the nitrogen base. Experimentally, we have found that the changes are either so small or so large that it is a relatively easy matter to say whether a stoichiometric compound and how many stoichiometric compounds will be formed under atmospheric pressure of hydrogen chloride. There are of course a certain number of cases that are about on the dividing line; but they are relatively few in number and they usually resemble the clear-cut cases sufficiently so that one can foretell that they will be doubtful cases, which is all that one needs for the present. We have been very much surprised to find how much simpler and how much more complete the classification turns out to be than we had expected. There are still some rough spots, cyaphenine for instance; but that is not serious.

We start with the postulate that in organic compounds all trivalent nitrogen atoms tend to take up hydrogen chloride stoichiometrically and to go over into pentavalent nitrogen. This tendency may be neutralized by the presence of certain radicals which may be considered as antagonistic. The degree of neutralization by any given radical in any given compound will of course vary with the temperature and with the pressure of the hydrogen chloride. Since the solid hydrochlorides are all formed with evolution of heat, so far as we now know, they will be less stable the higher the temperature. It is also very probable that at pressures of one hundred atmospheres or more of hydrogen chloride, much more hydrogen chloride would be taken up stoichiometrically in some cases than happens under more normal conditions. There is a good deal of evidence that more definite compounds are formed with sulphuric acid than with hydrogen chloride under any conditions yet

tried. There is some evidence that hydrogen fluoride will add on stoichiometrically under conditions under which hydrogen chloride will not.

Our present generalizations in regard to the effect of certain radicals, therefore, apply only to hydrogen chloride at ordinary temperatures and at atmospheric pressure.

I. The tendency for a nitrogenous compound to react stoichiometrically with hydrogen chloride is increased when hydrogen is replaced by an alkyl group and is decreased when the hydrogen is replaced by a phenyl group.

II. Introduction of so-called negative radicals, such as O, Cl, Br, NO<sub>2</sub>, etc, decreases the tendency of the nitrogenous compounds to react stoichiometrically with hydrogen chloride. These radicals have most effect when attached directly to the nitrogen.

III. Carbonyl groups attached directly to the nitrogen, or an aliphatic ethylene carbon linkage, decrease the tendency of the nitrogen to react stoichiometrically with hydrogen chloride. For convenience of discussion we shall call two carbonyl groups attached to nitrogen a diketo linkage, a CO group and a C:C aliphatic group attached to nitrogen a keto-ethylene linkage, and two C:C aliphatic groups attached to nitrogen a di-ethylene linkage. Two keto linkages or one keto and one ethylene linkage will destroy the tendency to add hydrogen chloride unless compensated by the presence of alkyl groups, etc. Since there are not many data at best, we usually mean methyl or ethyl groups when we speak of alkyl groups.

IV. Two or more nitrogens attached to the same carbon atom destroy the tendency to combine stoichiometrically with hydrogen chloride for all except one of the nitrogens, except in so far as this may be compensated by the introduction of alkyl groups.

V. In general, linkage of nitrogen to nitrogen seems to destroy the power of all but one of the nitrogens to combine stoichiometrically with hydrogen chloride, except in so far as this is compensated by the introduction of alkyl groups.

VI. Hydrogen chloride does not add direct to a nitrile nitrogen, an isonitrile nitrogen, or a cyanate nitrogen.

VII. If the nitrogen is already pentavalent through formation of an intramolecular salt, hydrogen chloride can only be taken up stoichiometrically in case it displaces the other acid.

VIII. Hydrogen chloride will add first to the nitrogen with which it will give the lowest dissociation pressure.

There is nothing new about these generalizations. They have either been made in some form by organic chemists or would be accepted by organic chemists as obvious platitudes. Some illustrations will prove this beyond any possibility of doubt.

Sidgwick<sup>1</sup> says: "The alkylamines are distinct bases, with an alkaline reaction to litmus, and they absorb carbon dioxide from the air. These properties are not shared by the aromatic amines which are much less basic.

<sup>1</sup> "The Organic Chemistry of Nitrogen," 18, 50, 51, 243, 363, 364, 388, 403, 406 (1910).

In fact the successive introduction of alkyl groups into ammonia increases the basicity, whilst that of aromatic groups diminishes it. . . . The quaternary [alkyl-aryl] hydroxide, unlike the primary, secondary, and tertiary bases, are strongly basic, caustic substances. . . . Phenylamine (aniline) has no alkaline reaction and does not absorb carbon dioxide: diphenylamine gives salts only with strong acids, and these are decomposed by water: triphenylamine gives no salts at all. . . .

"The primary and secondary aromatic hydrazines are decided monacid bases, forming salts with mineral and some organic acids. Unlike the primary fatty hydrazines they will not form salts with two equivalents of acid, but only with one. Secondary aromatic hydrazines, such as  $\phi_2\text{N.NH}_2$  will form salts with one equivalent of acid, but these are partially decomposed by water. This is like the behaviour of the secondary aromatic amines, and is a sign of the negative character of the phenyl group. . . .

"The reduced pyrrols have entirely lost the peculiar aromatic character of pyrrol, and behave as unsaturated or saturated fatty compounds. Thus pyrroline is a strong base, forming stable salts with acids, and giving a quaternary iodide with methyl iodide. . . . Successive methylation of pyrrolidine gives

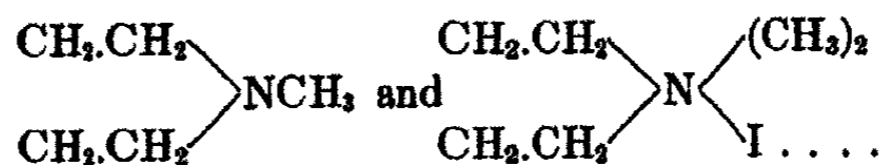

"Pyridine compounds are moderately strong bases though weaker than the reduced compounds such as piperidine. They form fairly stable salts with one equivalent of acid. . . . They are also able to add on alkyl iodide to form the pyridinium derivatives. . . . Quinoline closely resembles pyridine in behaviour. It is a tertiary base, and forms quaternary quinolinium iodides with the alkyl iodides. The corresponding hydroxides are strong bases; but, as with the pyridinium bases, the oxygen migrates very readily from the nitrogen to the carbon. . . . The unreduced isoquinoline compounds are tertiary bases, giving stable salts with acids and quaternary compounds with alkyl iodides. The stability of the pyridine ring is less in isoquinoline than in pyridine itself and in quinoline. Isoquinoline is more basic than quinoline and attracts carbon dioxide from the air."

Meyer and Jacobson<sup>1</sup> discuss one phase of the oxygen substitution. "The primary acid amides are like the amines in constitution; but quite different in chemical character. When an alkyl group is introduced into the ammonia molecule the basic nature of the substance is retained; the alkyl amines are powerful bases giving a strongly alkaline reaction. Introduction of the strongly electronegative acid radical into the ammonia molecule brings in a factor which tends to neutralize the basic character. The acid amides are therefore indifferent compounds giving a neutral reaction. The basic part of the molecule—the  $-\text{NH}_2$  group—is not completely paralyzed by the acyl radical. The acid amides have still the power to combine with strong acids

<sup>1</sup> "Lehrbuch der organischen Chemie," 1, §368 (1893).

to form instable compounds. Thus acetamide reacts with concentrated hydrochloric acid to form the compound  $\text{CH}_3\text{CO.NH}_2.\text{HCl}$ , which, on long standing over caustic soda goes over into the compound<sup>1</sup>  $(\text{CH}_3.\text{CO.NH})_2.\text{HCl}$ . This latter compound can be obtained directly in long pointed needles by passing hydrogen chloride into an ether-alcohol solution of the amide.<sup>2</sup> . . . These compounds (and the corresponding nitrates) react strongly acid and decompose readily. The alkylated amides<sup>3</sup> are more strongly basic." Meyer and Jacobson<sup>4</sup> say: "The hydroxyl derivatives of the aromatic hydrocarbons are more strongly acid and the amido derivatives less strongly basic than the corresponding aliphatic compounds. Thus the hydroxyl derivatives—the so-called phenols—dissolve in aqueous alkalis forming water-stable alkali salts, which the alcohols do not do. The amido derivatives, on the other hand, differ from the aliphatic amines, in not showing an alkaline reaction and in not absorbing carbon dioxide from the air. From these differences we draw the conclusion that the aromatic hydrocarbon radical is electronegative to the alkyl group."

We have already quoted van't Hoff as to the effect of oxygen and other negative groups on the basicity of nitrogen. The case for the halogen-substituted anilines was stated clearly by Hofmann<sup>5</sup> eighty-five years ago.

"From the foregoing experiments it appears, however, that the chlorine preserves to a certain extent, its electro-negative character in those compounds in which it replaces hydrogen, and that in proportion to the increase in the number of equivalents of the latter for which chlorine or bromine are substituted, so is this character the more impressed on the resulting compounds. The compound atom aniline,  $\text{C}_{12}\text{H}_7\text{N}$  [now written  $\text{C}_6\text{H}_5\text{NH}_2$ ], in consequence of the peculiar arrangement of its elements, possesses the property of uniting with an acid; replace one equivalent of its hydrogen by bromine and we obtain bromaniline, a body possessing likewise basic properties, but in a feebler degree. A number of metallic oxides, which can be precipitated from their solutions by aniline are not affected by the brominated base. Bromaniline is a less powerful base than aniline. By the assumption of the equivalent of the electro-negative body bromine, the basic properties of the original system is enfeebled; substitute now another bromine for hydrogen, and we have dibromaniline. The facility with which, as we mentioned, all its salts are decomposed, evidently indicates that the basic character of aniline is further enfeebled by the repeated assumption of bromide. Finally, in tribromaniline the electro-negative properties of the assumed bromine equivalents have placed themselves in equilibrium with the electro-positive character of the original system. Possibly, by the further addition of bromine, a body may be formed possessing acid properties."

<sup>1</sup> Pinner and Kern: Ber., 10, 1896 (1877).

<sup>2</sup> Strecker: Ann., 103, 321 (1857).

<sup>3</sup> Wallach: Ann, 214, 240 (1882).

<sup>4</sup> "Lehrbuch der organischen Chemie," 2, 43 (1902).

<sup>5</sup> Mem. Chem. Soc., 2, 298 (1845).

Roscoe and Schorlemmer<sup>1</sup> say: "The basic character of aniline is weakened much more by the introduction of nitroxyl than by that of a halogen atom; hence the mononitranilines are very weak bases, while the dinitranilines do not combine with acids, and trinitraniline behaves as an acid amide, being decomposed by alkalis with formation of ammonia and trinitrophenol (picric acid), on account of which reaction it was first named picramide. . . ."

"The amidophenols are obtained by the reduction of the nitrophenols as well as by heating amidosalicylic acid and its isomerides with caustic baryta. They are weak bases; their halogen-substitution products, on the other hand, behave like phenol, their acid character increasing with the number of hydrogen atoms replaced. The replacement of hydrogen by hydroxyl acts still more strongly this way."

Sidgwick<sup>2</sup> states: "The diminution of basicity on introducing halogen atoms is shown by the fact that while the mono-halogen anilines still give salts stable to water, the di-halogen compounds give salts which, if the acid is volatile, are largely decomposed on evaporating their aqueous solutions i.e. which are highly hydrolyzed; while the tri-halogen derivatives give no salts at all. . . ."

"The influence of substitutes on the basicity of aniline has been investigated by Farmer and Warth.<sup>3</sup> . . . The general conclusions are that the ortho position gives the greatest effect and the meta the least; and, as regards the nature of the substituents, the effect is in the order (strongly negative) NO<sub>2</sub>, CO<sub>2</sub>H, N:Nφ, Br, Cl, CH<sub>3</sub>O. (weakly positive)."

The effect of one carbonyl group attached to nitrogen has been discussed by Sidgwick.<sup>4</sup> "The amides are comparable in constitution to the primary amines, but differ from them markedly in behaviour. The electro-negative acyl group makes them indifferent substances of neutral reaction. The basic character of the NH<sub>2</sub> group is not wholly destroyed and they are able to form salts with strong acids; but these have a strongly acid reaction and are highly hydrolysed. The alkylated amides are more basic and can give double platinichlorides. In consequence of the more negative character of the amides as compared with the amines, the hydrogen is more easily replaced by metals. Thus an aqueous solution of an amide dissolves mercuric oxide, and on evaporation salt-like bodies such as Hg(NHCOCOCH<sub>3</sub>)<sub>2</sub> crystallize out. This is the general behaviour of NH attached to negative groups, as shown in isocyanic acid, H.N:C:O, and in phthalimide." The effect of two carbonyl groups in making the intervening group less basic and consequently the more acidic is well shown in malonic ester where one hydrogen of the CH<sub>2</sub> group is easily replaceable by sodium.

Sidgwick<sup>5</sup> has also discussed the CO.C.NH<sub>2</sub> group in connection with the diazo reaction. "Diazoacetic ester, the first member of the group to be

<sup>1</sup> "Treatise on Chemistry," 3 III, 233, 247 (1887).

<sup>2</sup> "The Organic Chemistry of Nitrogen," 54 (1910).

<sup>3</sup> J. Chem. Soc., 85, 1713 (1904).

<sup>4</sup> "The Organic Chemistry of Nitrogen," 80 (1910).

<sup>5</sup> "The Organic Chemistry of Nitrogen," 335 (1910).

discovered by Curtius in 1883, by the action of potassium nitrite on glycollic ester hydrochloride:—

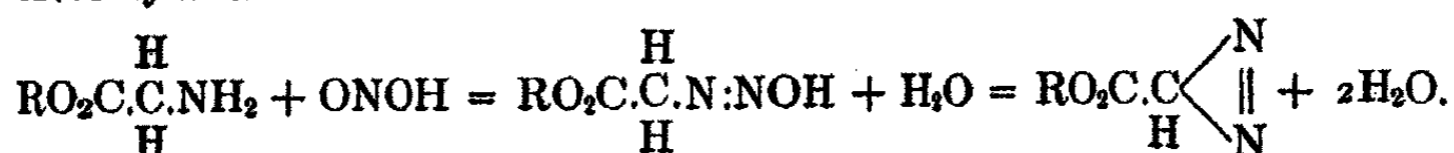

“It is to be noticed that glycollic does not give any diazo-compound with nitrous acid, but goes directly to glycollic acid with elimination of nitrogen. The whole question of the conditions which determine the reaction of an  $\text{NH}_2$  group with nitrous acid is very obscure. The main facts, as far as they are known, are these. Apart from the simple formation of a nitrite, which occurs in some cases, there are three possible reactions. First, the  $\text{NH}_2$  groups may be replaced by hydroxyl, which is the most frequent case, occurring with all ordinary alkylamines and with all amides. Secondly, a true open-chain diazo-compound may be produced, a fatty diazo-compound. Thirdly, a ring compound may be produced. This last reaction obviously requires that there should be a hydrogen atom on the same carbon atom as the  $\text{NH}_2$ ; if this is absent, as in the aromatic amines, only the first or the second reaction can take place. In fact there are two questions concerned, first, whether an alcohol or an open-chain diazo-compound is the primary product, and secondly, whether the latter, if produced, goes over at once into the ring compound.

“As regards the first question, the normal reaction is the production of a hydroxyl compound. The formation of a diazo compound of any sort seems to depend on the presence of acidic groups in the neighborhood of the  $\text{NH}_2$ , though it is by no means all acidic groups which will produce this effect, and in particular it does not occur with amides, which are always converted into the acids.

“But, at any rate, those amines which give diazo-compounds are always of a more or less negative character. They comprise in the first place the aromatic amines, in which the  $\text{NH}_2$  is attached to the negative benzene nucleus. The only fatty amines which give this reaction are those which contain a carbonyl group, and it would seem that this must be in the alpha-position to the  $\text{NH}_2$ , i.e. that the compound must contain the grouping  $\text{CO.C.NH}_2$ . Thus, among the amino-acids, Curtius<sup>1</sup> finds that the free acids never form diazo-compounds, and of the esters only those which have the  $\text{NH}_2$  in the alpha-position to the carboxethyl. For example,  $\alpha$ - $\beta$ -diaminopropionic ester gives  $\alpha$ -diazo- $\beta$ -oxypropionic ester. He has recently shown that the esters of the polypeptides which have the  $\text{NH}_2$  in the same relative position to the carbonyl, can likewise be converted into diazo-compounds:—

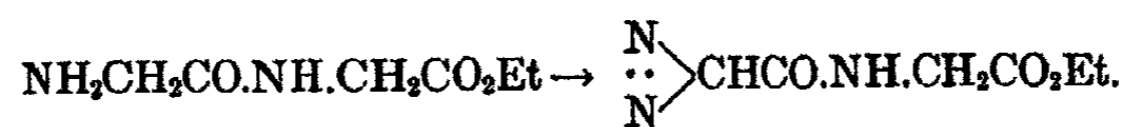

Again the alpha-amino-ketones, such as amino-acetophenone,  $\varphi\text{COCH}_2\text{NH}_2$

<sup>1</sup> Curtius and Müller: Ber., 37, 1261 (1904); Angeli: 26, 1715 (1893).

will give diazo-compounds (Angeli), these also containing the group CO.C.NH<sub>2</sub>. The same rule holds with certain uric acid derivatives such as amino-

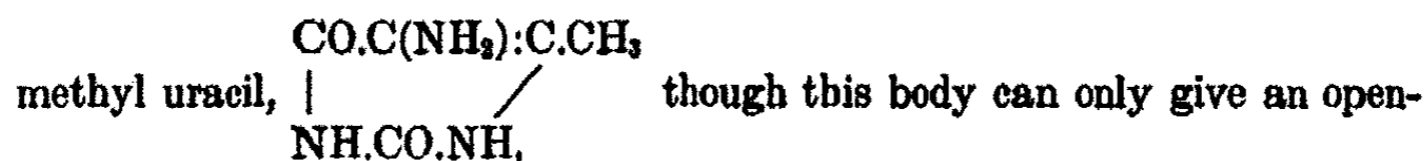

chain compound as there is no hydrogen on the carbon carrying the NH<sub>2</sub>. On the other hand, the presence of hydrogen on the carbonyl carbon prevents the formation of diazo-derivatives, as is shown by the behaviour of the free amino-acids. Further, it is found that while the presence of the hydrogen atom on the same carbon as the NH<sub>2</sub> is necessary for the production of a ring diazo-derivative, the stability of this body is greatly increased if there is a second hydrogen atom, i.e. if we start with a body —CH<sub>2</sub>.NH<sub>2</sub> and form a diazo-compound —CH.N<sub>2</sub>. It is possible that this may be due to the body being then able to assume the tautomeric structure  $\begin{array}{c} \text{—C—NH} \\ \diagdown \quad | \\ \quad \quad \text{N} \end{array}$ , although, as

we shall see later, the supposed evidence for the existence of compounds of this type has been shown to be incorrect."

Sidgwick<sup>1</sup> gives a discussion of the —C:C— group; but it is not very satisfactory if the same reasoning is to be applied to the benzene ring. "Pyrrol is a colourless liquid boiling at 131°, which smells like chloroform. It appears from its formula as a secondary amine; but its basic properties are extraordinarily weak. They are to some extent concealed by the fact that pyrrol and most of its homologues are very easily converted by strong acids into complicated polymers; but even when these bodies are not formed and the salts can be obtained, they are at once hydrolysed by water. In dilute acids pyrrol only dissolves slowly; and the tendency of the nitrogen to pass into the pentad condition is so slight that it will not combine with alkyl iodide.

"The weak basicity of the pyrrols is obviously related to their peculiar aromatic character. The remarkable point about this is that whereas thiophene and its homologues resemble the aromatic hydrocarbons, as has so often been emphasized, the striking analogy of pyrrol is not to the hydrocarbons but to the phenols. . . .

"Marckwald<sup>2</sup> has pointed out that the fact that the NH is attached to two —C:C— groups is itself sufficient to explain its feeble basicity, as is illustrated in the case of diphenylamine and dihydro-acridine which contain the same grouping and exhibit the same suppression of basic properties. The highly negative influence of this structure is further shown in indene

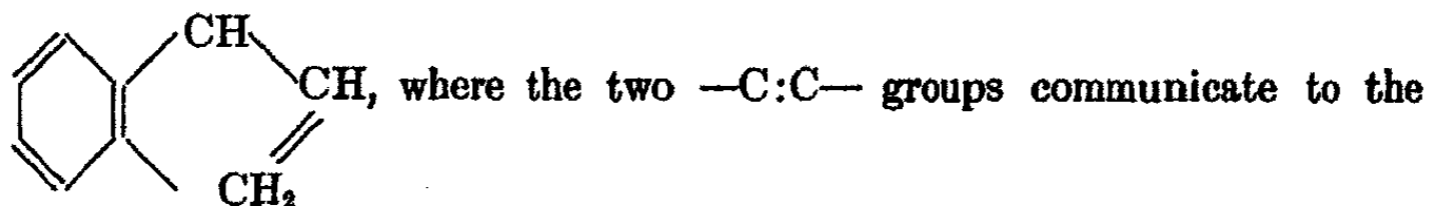

<sup>1</sup> "The Organic Chemistry of Nitrogen," 353, 358 (1910).

<sup>2</sup> Ann., 279, 8 (1894); Ber., 28, 114, 1501 (1895).



"Thiele has now introduced a greater flexibility into our conception of linkage, and we may fairly adopt a modified form of Bamberger's suggestion. It must be modified because pyrrol is much less completely saturated than benzene, as is shown by its behaviour on oxidation. But we may suppose that in pyrrol and similarly in thiophene and furfurane, the higher valency of the nitrogen (or the sulphur or the oxygen) is partially exerted, and that thus there are two bonds which can go somewhat toward saturating the residual valences of the carbon in the two alpha-positions. This would be expressed in Thiele's symbols by the formula

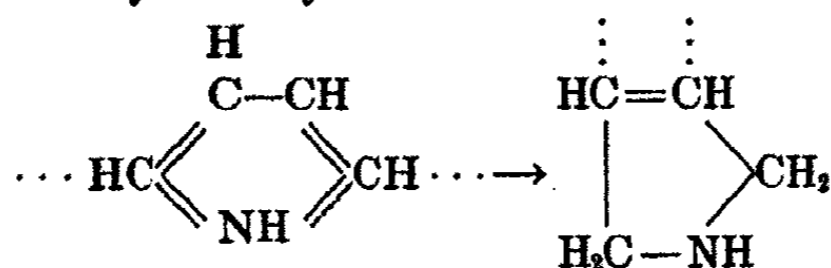

On reduction this passes, as benzene does, into an ordinary saturated system. In this way we get an explanation of the peculiar, so to speak semi-aromatic, character<sup>1</sup> of pyrrol."

We cannot accept the double bond explanation for diphenylamine. We have to postulate that the decreased basicity is due to the effect of the phenyl groups as such. Otherwise, we should have to conclude that acetanilide should not add on hydrogen chloride and it does. It would, therefore seem wiser to attribute the weak basic character of pyrrol to the ring structure. If it is due to two ethylene linkages, we must conclude that the diethylene linkage does not destroy the basicity completely as the diketo linkage normally does.

The negative effect of the ring structure has been suggested by Marckwald<sup>2</sup> to account for pyridine<sup>3</sup> and tetrazene. "Pyridine is a weak base of about the strength of aniline; but it is much stronger than pyrrol and forms fairly stable salts. . . . Marckwald points out that a nitrogen atom in a ring is able to behave under certain circumstances as a strongly negative group.

For example, tetrazol  $\overline{\text{HN.CH:N:N:N}}$  is an acidic compound which reddens blue litmus. This is not necessarily incompatible with the nitrogen also possessing basic properties, i.e. the power of becoming pentad."

By what he does not say, Marckwald recognizes indirectly that a four-nitrogen chain will probably not add on four hydrogen chlorides stoichiometrically. We have not yet been able to find any positive statement anywhere as to the effect of nitrogen linked to nitrogen, perhaps because any such statement would seem inconsistent with the behavior of the alkyl hydrazines.

Decker<sup>4</sup> has discussed the substitution products of pyridine in a rather unsatisfactory way. "One essential difference strikes one at once between

<sup>1</sup> Ciamician: Gazz., 35 II, 384 (1905).

<sup>2</sup> Ber., 26, 2187 (1893); 27, 317 (1894).

<sup>3</sup> Sidgwick: "The Organic Chemistry of Nitrogen," 386 (1910).

<sup>4</sup> J. prakt. Chem., (2) 45, 51 (1892).

the action of the nitric acid, the halogens, and sulphuric acid on pyridine, quinoline, and acridine, and their reaction on aniline or naphthylamine. A study of substitution reactions in pyridine, which gives the closest analogy with the behavior of the pyridine ring in quinoline, shows that, in the few cases in which substitution takes place at all, the substituting groups go in exclusively in the beta position. . . . The reason why the tertiary nitrogen in the aromatic ring behaves like a strongly aromatic radical, and not like the amido group in benzene and naphthalene is that the substitution reactions take place in acid solution and that the reaction is not really with pyridine or quinoline but with their salts or halogen addition products. This explains why substitutions in the pyridine ring may take place only at relatively high temperatures, at which the salts or addition products begin to dissociate. It is well known that up to now no nitro derivatives of pyridine could be prepared; in the cold there was no nitrification because the pyridine ring is negative in acid solution; at higher temperatures the nitric acid causes oxidation.

"The trivalent nitrogen in the ring is more negative than the CH group and therefore we have a greater stability of the alpha and gamma halogen derivatives with respect to alcoholic potash and aniline and a ready splitting-off of the carboxyl group in the alpha position."

Marckwald<sup>1</sup> is quite definite. "The resistance that pyridine offers to the entrance of a nitro group is the rock on which all previous attempts at nitration have failed. It depends obviously on the fact that the nitrogen, despite its basic character, acts as a strongly acidifying group. In this respect pyridine behaves like a benzene with a very strongly negative substitution-radical. Thus substituents always go into the beta-position with pyridine, the meta-position with regard to the nitrogen atom. While the nitro group cannot be introduced at all into pyridine, it is only with difficulty and to a limited extent that one introduces the sulphonic group, which is also strongly negative.<sup>2</sup> It is probably for the same reason that the acid character of the imide group in pyrrol is increased more and more by successive replacement of the methanyl groups by nitrogen atoms, so that Bladin's tetrazene<sup>3</sup> shows no basic properties at all but even reddens blue litmus paper.

"Finally the acidifying action of the pyridine atom shows itself in the alpha and gamma-substitution products of this base. In these the halogen is about as mobile as in the ortho and para halogen-substitution products of nitrobenzene. On the other hand, the chlorine in beta-chloropyridine is held extremely firmly, just as there is no mobility of the chlorine atom in meta-chloronitrobenzene."

The diazonium salts<sup>4</sup> are now generally considered to contain pentavalent nitrogen. "We will consider first salts of the diazo compounds with the

<sup>1</sup> Ber., 26, 2187 (1893).

<sup>2</sup> Fischer and Renouf: Ber., 17, 763 (1884).

<sup>3</sup> Bladin: Ber. 25, 1411 (1892).

<sup>4</sup> Sidgwick: "The Organic Chemistry of Nitrogen," 264, 270 (1910).

mineral acids. Here the evidence is conclusive in favour of Blomstrand's pentad nitrogen formula, which Hantzsch has called the diazonium formula, to indicate its analogy to that of the ammonium salts:—

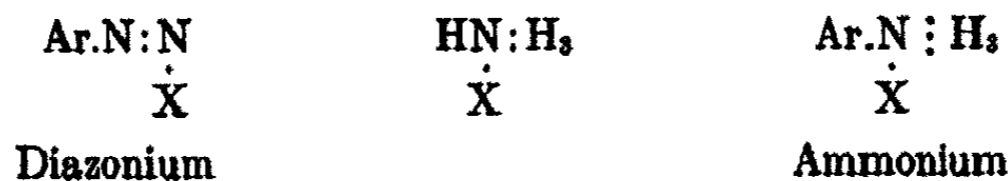

This was revived by Bamberger in 1895 in opposition to Hantzsch's stereochemical views; it was soon adopted by Hantzsch himself to whom the most important arguments in its favour are due. These consist in an elaborate comparison of the chemical and physico-chemical properties of the salts with those of the corresponding salts of the alkalies and the quaternary ammonium bases.

"In the first place, it is obvious that the diazo-salts do not behave like compounds of triad nitrogen. We have an example of triad nitrogen with a hydroxyl group attached in hydroxylamine,  $\text{NH}_2\text{OH}$ . This is not only a very weak base, but when it forms salts with acid it does so by addition, giving, for example, a hydrochloride,  $\text{H}_2\text{NOH.HCl}$ . The diazo salts, on the other hand, are derived from a very strong base, which in some of the substituted compounds is far stronger than ammonia, and almost if not quite as strong as the alkalies. Also when it forms salts it does not do so by addition, but by replacing the hydroxyl by an acid radical. In both of these points it closely resembles a quaternary ammonium hydroxide, such as  $\phi\text{N}(\text{CH}_3)_3\text{OH}$ .

"Again, diazonium chloride and nitrate have a neutral reaction; they are not hydrolyzed in aqueous solution, while they are ionized to the same high degree as potassium chloride or nitrate, not only in aqueous but also in alcoholic solution;<sup>1</sup> and the cation has almost the same velocity as that of an alkali metal or ammonium.<sup>2</sup> The carbonates, like some of the alkalies, are soluble in water and of a strong alkaline reaction. The double salts<sup>3</sup> resemble those of the alkalies. The platinichlorides,  $(\text{ArN}_2)_2\text{PtCl}_6$  have long been known; and Hantzsch has shown that the diazonium salts give cobaltinitrites and soluble chlorides with mercuric chloride analogous to those of potassium and ammonium. Further, as will be shown later, the cyanide forms a double salt with silver cyanide,  $\text{ArN}_2.\text{Ag}(\text{CN})_2$ , closely resembling in behaviour potassium silver cyanide,  $\text{KAg}(\text{CN})_2$ .

"A direct determination of the affinity constant of phenyl-diazonium hydrate showed that while it is a decidedly weaker base than tetramethyl-ammonium hydrate it is still nearly seventy times as strong as ammonium hydrate. The strength is greatly increased by the introduction of negative groups like bromine, but on the other hand it is enormously increased by positive groups such as methyl or methoxyl.<sup>4</sup> Thus anisol ( $\text{CH}_3\text{OC}_6\text{H}_4-$ )

<sup>1</sup> Hantzsch and Davidson: Ber., 31, 1612 (1898).

<sup>2</sup> Hantzsch: Ber., 28, 1740 (1895); Hantzsch and Davidson.

<sup>3</sup> Hantzsch and Danziger: Ber. 30, 2529 (1897).

<sup>4</sup> Hantzsch and Engler: Ber., 33, 2147 (1900).

and pseudocumene  $(\text{CH}_3)_2\text{C}_6\text{H}_2-$  diazonium hydrates are, like the alkalies, such strong bases that their strength cannot exactly be measured.

“Moreover, it has been shown that the only ions into which the hydrate breaks up are  $\text{Ar}\cdot\text{N}_2$  and  $\text{OH}$ , that is to say, that it is a true hydroxide. This excludes the nitrosamine formula, and leaves us only the choice between

$\text{Ar}\cdot\text{N}:\text{N}\cdot\text{OH}$  and  $\text{Ar}\cdot\text{N}\begin{array}{l} \text{N} \\ \parallel \\ \text{OH} \end{array}$ ; and the highly basic character of the compounds makes it certain that they must contain pentad nitrogen.

“A further point of resemblance between the diazonium and the ammonium compounds is found in the perhalides. These are formed by the action of the halogens on the diazonium halides and have the composition  $\text{Ar}\cdot\text{N}_2\text{Hal}_3$ . They were originally written on the type  $\text{ArN}-\text{N}-\text{Br}$ . But



it has been shown by Hantzsch<sup>1</sup> that they are strictly analogous to the alkaline perhalides  $\text{KI}_3$ . The diazonium perhalides, like those of the alkalies, are coloured, are not very soluble in most solvents, and readily break up again into the simple halide and free halogen. The resemblance is most marked between the diazonium compounds and those of caesium. Taking the three halogens, chlorine, bromine, and iodine, and neglecting structural or stereoisomerism, ten compounds  $\text{XHal}_3$  are possible. Of these in the diazonium series nine are known—all but  $-\text{Cl}_3$ , and in the caesium eight—all but  $-\text{Cl}_3$  and  $-\text{I}_2\text{Cl}$ . The similarity in colour is most striking. In both series you start with a blue-black, almost opaque, tri-iodide, and the colour gets lighter as the atomic weight of the halogen diminishes, passing through red, orange ( $-\text{Br}_3$ ), and yellow, and ending with the pale yellow  $-\text{Cl}_2\text{Br}$ . In colour and in stability the corresponding members of the two series are almost identical. . . .

“It has been shown that all quaternary ammonium hydroxides in which the nitrogen is either doubly linked to carbon, or forms part of a ring, are liable to a peculiar transformation in the presence of a base, the hydroxyl migrating from the nitrogen to another part of the molecule, forming a substance which is no longer a base. In other words they are pseudo-bases. Of the first kind we have already had an example in the triphenyl-methane dyes, where the highly ionized salt,  $\text{X}_2\text{C}:\text{C}_6\text{H}_4:\text{NH}_2\cdot\text{Cl}$ , on treatment with alkali first gives the corresponding hydroxide  $\text{X}_2\text{C}:\text{C}_6\text{H}_4:\text{NH}_2\cdot\text{OH}$ , which then changes spontaneously into the undissociated carbinol  $\text{X}_2\text{C}(\text{OH})\cdot\text{C}_6\text{H}_4\text{NH}_2$ . That is, the nitrogen becomes triad through the migration of the hydroxyl to another atom, and a non-basic substance is formed. Another such case is that of the pyridonium salts, when the base changes over into the non-basic oxypyridine:—

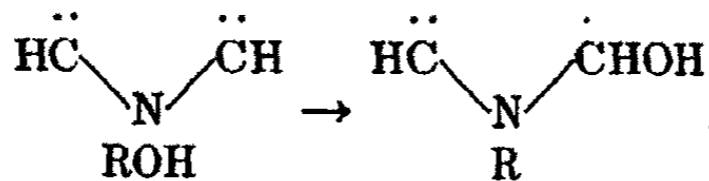

<sup>1</sup> Ber. 28, 2754 (1895).

"Now diazonium hydroxide is a substance peculiarly adapted for this kind of ionization-isomerism. The basic nitrogen is triply linked to another nitrogen atom, and it is quite probable that, in the presence of a base the hydroxyl of the undissociated portion) may at any rate partially migrate to this:—

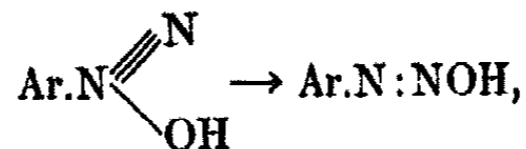

the body changing, to use Hantzsch's nomenclature, from a diazonium to a diazo-hydrate. This change is not hypothetical. It is absolutely required to explain the extraordinary behaviour of diazobenzene hydrate. It has been shown that the strongest argument for the diazonium structure of the dissociated part is its powerfully basic character. A diazo-hydroxide would be a weak base, like hydroxylamine. But though it is so strong a base, yet it is capable of forming a salt with potash, the normal diazotate. . . .

"The diazotates are distinct salts, derived from a weak, but not excessively weak, acid  $\text{ArN}_2\text{OH}$ . This unique behaviour of diazobenzene hydrate must be due to isomerism. The substance which reacts as a strong base must have a different structure from that which reacts as a weak acid; and,

if so, it is clear that the base must be the diazonium compound  $\text{Ar.N} \begin{array}{l} \equiv \text{N} \\ \diagdown \\ \text{OH} \end{array}$ ,

analogous to ammonium hydrate, and the weak acid the diazo body  $\text{Ar.N:N.OH}$ , corresponding to hydroxylamine. This hypothesis will also account for the unusual behaviour of sodium normal diazotate. This body, as the salt of a weak acid, is hydrolysed in water to an extent which can be determined by conductivity measurements. But the hydrolysis increases with the dilution enormously faster than in any other known case. It is hard to see how this can be explained except by supposing that the equilibrium is destroyed by the weak acid first liberated going over into the ions of the strong diazonium base.

"So far, then, we may conclude that the mineral acid salts of diazobenzene have the diazonium structure, but that, on addition of a base, the hydrate which is first formed changes over to give the alkaline salts of the weakly acidic diazo hydrate  $\text{Ar.N:NOH}$ , which are the normal diazotates."

"The anti-diazo-hydrates are prepared by precipitating the solution of an anti-diazotate with the calculated quantity of acetic acid at a low temperature. They are colourless crystalline compounds which are very unstable and are converted even by dissolving in water into the nitrosamines:—

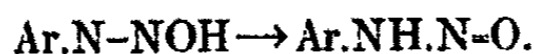

It is however, possible, by taking proper precautions, to isolate and examine these anti-diazo-hydrates. They behave as true acids. They react as hydroxyl compounds with phosphorus pentachloride, with acid chlorides, and with phenyl isocyanate; and they give the ammonia reaction. They also couple fairly rapidly with phenols.

"If an anti-diazotate is treated with acid without special precautions, or if an anti-diazo-hydrate is allowed to stand, the nitrosamine is produced. Owing to this fact, the diazotate behaves at the ordinary temperature as the salt of a pseudo-acid. Its solution, when treated with an equivalent of hydrochloric acid, has the conductivity of the potassium chloride which it contains. The nitrosamines are yellow crystalline compounds, rather sparingly soluble in water and easily in organic solvents. As pseudo-acids they have a neutral reaction, but neutralize an alkali; and they do not give the ammonia reaction. They do not react with phosphorus pentachloride in the cold, and hence do not contain a hydroxyl group. They couple very slowly with phenols. Mineral acids in the presence of water convert them into diazonium salts, but dry hydrochloric acid combines with them in ethereal solution without isomeric change to give the nitrosamine salt  $\text{Ar.NH.NO.HCl}$ ."

This last sentence is very important. Substances may be stable with hydrogen chloride in ether when they are decomposed by aqueous hydrochloric acid. It is quite possible that ether might have a disturbing effect in some cases and that it might be possible to eliminate decomposition more completely by the action of moderately dry hydrogen chloride on the solid substance. One experiment of this sort that ought to be tried is the action of hydrogen chloride on tetraphenyl hydrazine.

As Hantzsch and Engler<sup>1</sup> point out: "The strength of the diazonium bases varies extraordinarily. The group includes bases (almost) of the strength of caustic potash and also bases weaker than ammonia. Very surprising is the enormous effect on the strength of many substituents in the benzene ring. Nothing like it is found in any other group of bases. Just through the introduction of methoxyl (a not-especially positive group), the ammonia bases and especially the ordinary diazonium hydroxide, which is about the same strength as piperidine, become very nearly equal to potassium hydroxide. On the other hand, the weakening of the positive character by bromine is about normal and is much less than the enormous increase due to introducing the methoxyl group at the same place."

This question of substituents comes up in another form.<sup>2</sup> Bamberger<sup>3</sup> stated that the action of hydroxylamine on a nitroso derivative produced the iso- or anti-diazotate; but Hantzsch<sup>4</sup> has been able to show that it is really the syn-diazotate which is formed. This is to be expected if we suppose that an intermediate addition-compound is formed, which then loses a hydrogen and a hydroxyl which are near to one another:—

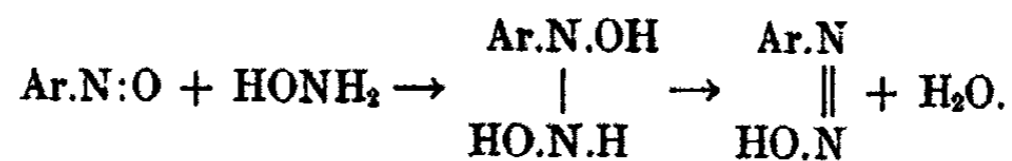

"It is evident from the foregoing that the constitution of the diazo-complex in a compound  $\text{Ar.N}_2\text{X}$  is mainly determined by the nature of the radical X.

<sup>1</sup> Ber., 33, 2148 (1904).

<sup>2</sup> Sidgwick: "The Organic Chemistry of Nitrogen," 277 (1910).

<sup>3</sup> Ber., 28, 1218 (1895).

<sup>4</sup> Ber., 38, 2056 (1905).

But it is also affected by the nature of the aryl radical, or in other words by the substituents on the benzene ring. The main directions in which this latter influence acts have been determined by Hantzsch, by the investigation of a large series of compounds. They are as follows: The more important substituents are on the one hand alkyl groups and methoxyl, which render the nucleus more basic, and on the other halogen atoms, which make it more negative or acidic. As regards the relation between the diazonium and syn-diazo bodies, it is found that the more basic the nucleus is, the more the diazonium form is favoured; and the more negative the more the syn-diazo. Thus the trimethyl-diazonium bromide is almost colourless and hardly explosive, while the tribrom-diazonium bromide is very explosive and deeply coloured; hence the former consists mainly of the diazonium, the latter mainly of the syn-diazo. So, too, the trimethyl-diazonium cyanide in aqueous solution is almost wholly in the form of diazonium cyanide ions, of which the tribromo-derivative scarcely forms any. Again, the trimethyl-diazonium hydrate is nearly as strong as potassium hydrate, while the tribromo-diazonium hydrate is weaker than ammonia, that is, it contains very little dissociated diazonium hydrate.

"Between these two extreme limits come the other diazo-compounds, for which the same general rule holds: the fewer alkyls or the more halogen atoms there are on the ring, the less tendency to produce the diazonium form. It is to be observed that the methoxyl group has the same powerful basic influence as the alkyl; a conclusion to which Baeyer had also come from a study of the aromatic oxonium salts.

"The relations among the true diazo-compounds between the syn- and anti-series are less regularly affected. In the diazotates the change of syn-into anti- is hindered by methyl groups and promoted by halogens; while in the sulphonates and the cyanides exactly the reverse effect is produced, the more positive compound changing the most rapidly. The presence of nitro-groups increases the velocity of the change in all cases.

"The conversion of the anti-diazo-hydrates into the nitrosamines seems to be hastened by the presence of halogen atoms."

There is no question in anybody's mind of the nitriles adding on hydrogen chloride or bromide to form pentavalent nitrogen compounds. These acids do combine stoichiometrically<sup>1</sup> with some of the nitriles; but the halogen adds to the carbon and not to the nitrogen.

"With hydrochloric acid, the nitriles form imino-chlorides or in alcoholic

solution imino-ethers:—  $\text{CH}_3\text{C}:\text{N} + \text{HCl} = \text{CH}_3\overset{\text{Cl}}{\underset{|}{\text{C}}}\text{:NH}$ . With hydrobromic acid an apparently different reaction occurs; two molecules are taken up instead of one, and an amido-bromide is formed:—

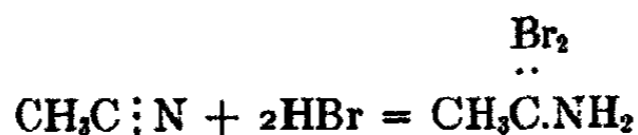

<sup>1</sup> Sidgwick: "The Organic Chemistry of Nitrogen," 205, 193, 344, 207 (1910).

The difference is really in the conditions of the experiment. Bromine first substitutes in the alkyl group, and then the hydrobromic acid so produced adds on to form an imino-bromide:—

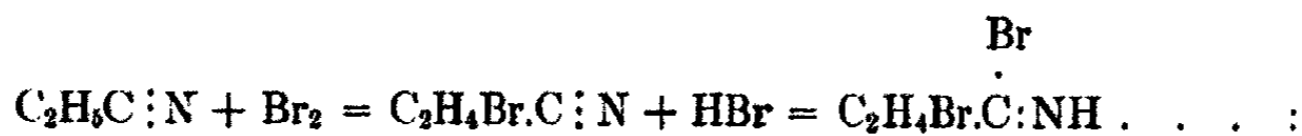

"Prussic acid combines with hydrochloric acid in ethyl acetate solution, giving a body of the composition  $2\text{HCN} \cdot 3\text{HCl}$ . The formula of this substance has been shown to be  $\text{HC} \cdot \text{NHCHCl}_2 \cdot \text{HCl}$ . [The third hydrogen



chloride has produced pentavalent nitrogen, but not the first two.] It is dichlormethylformamidine hydrochloride . . . . Hydrocyanic acid can also form a simpler compound with hydrochloric acid, iminoformyl chloride,



$\text{Cl}:\overset{\text{H}}{\text{C}}:\text{NH}$ . This body cannot be isolated, but its formula is proved by Gattermann's reaction for the synthesis of aldehydes.<sup>1</sup> If an aromatic hydrocarbon or a phenol ether is heated with prussic acid and hydrochloric acid, either alone or in presence of a condensing agent such as zinc chloride or aluminum chloride, it is converted into an aldimine from which the aldehyde is easily obtained by heating with dilute acid. This can only be explained by the intermediate formation of the imino-formyl chloride:—

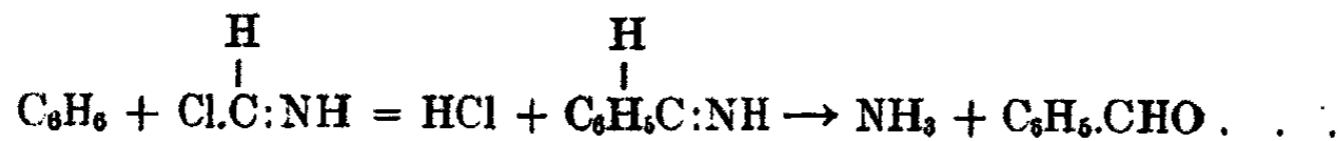

Sidgwick has apparently overlooked or discredited the work of Gautier.<sup>2</sup> "When one passes dry hydrogen chloride into anhydrous prussic acid kept at  $-15^\circ$  in a strong flask, a large amount of the hydrogen chloride dissolves. When the solution is saturated, the flask may be removed from the freezing mixture and one can satisfy oneself, by immediate distillation for instance, that no combination has taken place. If one seals the flask hermetically and places it for a few minutes in a bath at  $35^\circ$ - $40^\circ$  and then lets it cool down, at some moment during the cooling, there will be a rapid reaction, the mass will heat up and a portion will crystallize. If one chills again, pours off what liquid there is, and repeats several times, one can change most of the hydrocyanic acid into hydrochloride. The two substances do not react as gases."

\* Of course there is nothing to show that this may not have been a polymer of imino formyl chloride except perhaps the ready reversibility. "If the dry hydrochloride is placed in a vacuum, the whole solid may disappear." Special experiments showed that this vaporization was due to a decomposition into hydrogen chloride and hydrogen cyanide.

<sup>1</sup> Ann. Chim. Phys., (4) 17, 129 (1869).

<sup>2</sup> Ber., 31, 1149, 1765 (1898); Ann., 347, 347 (1906); 357, 313 (1907).



Gautier found that hydrogen bromide reacts more vigorously producing  $(\text{HCN})_2(\text{HBr})_3$ , corresponding to the hydrogen chloride compound obtained in ethyl acetate. It is quite possible that the second stage is the reaction  $2 \text{HC}(\text{Cl})\text{:NH} = \text{HN}\text{:CH.C}(\text{Cl}_2)\text{NH}_2$ .

"Sulphuric acid condenses with hydrocyanic acid (one molecule of the latter with two of the former) to give a disulphonic acid which can be shown to be a primary amine: for example, by its giving Hofmann's test with chloroform and potash. It must, therefore, be aminomethane disulphonic ester

$\begin{matrix} \text{SO}_3 \\ \diagdown \\ \text{C} \\ \diagup \\ \text{SO}_3 \end{matrix} \begin{matrix} \text{NH}_2 \\ \diagup \\ \text{C} \\ \diagdown \\ \text{H} \end{matrix}$ . When this is treated with nitrous acid it forms diazomethane disulphuric acid:—

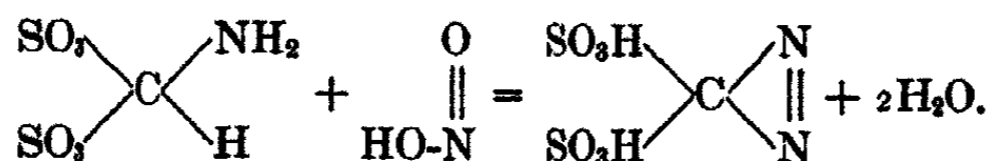

This body shows all the reactions of fatty diazo-compounds: for example, with iodine it gives nitrogen and di-iodo methane sulphonic acid, so that there can be no question about its constitution. It is to be noticed that we have here the case of a fatty compound which is capable of being diazotized, although it does not contain the group  $\text{CO.C.NH}_2$ . But it has a very similar structure. It contains an  $\text{NH}_2$  in the alpha-position to a strongly negative group, namely, the  $\text{SO}_3\text{H}$  group. It is also to be observed that in this case the free acid can be diazotized, whereas the aminocarboxylic acids must first be converted into their volatile esters. . . .

"The isocyanides are volatile liquids with a very powerful and extraordinarily repulsive smell. They are not basic, but nevertheless combine with hydrochloric acid in ethereal solution to form compounds such as  $2\text{CH}_3\text{NC}$ ,  $3\text{HCl}$ ; these, however, are not stable to water."

The existence of intramolecular salts with pentavalent nitrogen<sup>1</sup> is well-recognized. "The mono-sulphonic acids of aniline are colourless bodies which crystallize well. . . . They form salts with bases but not with acids, and hence dissolve in aqueous alkalies and are reprecipitated by acids. All these peculiar-

ities indicate that they are intramolecular salts, e.g.  $\text{H}_4\text{C}_6 \begin{matrix} \text{NH}_3 \\ \diagdown \\ \text{C} \\ \diagup \\ \text{SO}_2 \end{matrix} \text{O}$ , as in

the parallel case of the amino acids. This is confirmed by the fact that they cannot be acetylated, while their sodium salts, which must have a free  $\text{NH}_2$  group, can."

According to Meyer and Jacobson,<sup>2</sup> taurine crystallizes in large transparent columns and dissolves in 15.5 parts of water at  $12^\circ$ ; it reacts neutral and is therefore to be considered as an intramolecular ammonium salt in which the basic and the acid parts neutralize each other:

<sup>1</sup> Sidgwick: "The Organic Chemistry of Nitrogen," 55 (1910).

<sup>2</sup> "Lehrbuch der organischen Chemie," 1, 636 (1893).

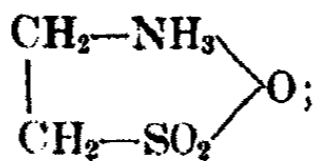

thus explaining why the amino group in taurine does not combine with acids to form salts."

The aqueous solution of methyl taurine<sup>1</sup> reacts very distinctly acid. Nevertheless, it is much less acid than taurine. The latter is not precipitated from an alkaline solution by alcohol, from which one concludes that there is formed a salt soluble in alcohol. A not too dilute alkaline solution of methyl taurine becomes turbid at once on the addition of alcohol, owing to precipitation of unchanged methyl taurine.

"It is readily soluble in strong acids, hydrochloric acid and nitric acid, but crystallizes unchanged from the partially evaporated solution. All attempts were in vain to make a double salt of methyl taurine hydrochloride by adding platinum chloride to an acid solution of methyl taurine.

Dimethyl and diethyl taurine<sup>2</sup> both react acid in aqueous solution and neither one adds hydrogen chloride stoichiometrically. What was supposed to be trimethyl taurine, proved to be the methyl ester of dimethyl taurine. It reacts neutral; but, unfortunately, the author did not test for a hydrochloride, which he would undoubtedly have found."

In spite of this mass of general information, nobody seems to have tried to collate the data carefully and systematically. Spiegel did not do it. Sidgwick did not do it. Several organic chemists, to whom we have talked, have assured us that it would be impossible to get results of any real value out of such a study. Actually, the matter seems to be extremely simple and one that anybody could have handled.

The chief difficulty probably has been that the people before us had too much respect for existing data. It would be quite impossible to bring order out of chaos if one were to accept all the data that are given in the literature. It was necessary to assume that the problem was quite simple and then to have confidence that the theory was more accurate than the data. So far, every case that has been checked is in agreement with the theory as now presented.

The errors in the observation are all in one direction. We have not found any case in which the amount of hydrogen chloride taken up was less than that found by observers using a different technique; but there have been many cases where more hydrogen chloride is taken up stoichiometrically than has been found by anybody else. The most striking case of this is hexamethylene tetramine. We have found no statement in the literature indicating that more than one hydrogen chloride is taken up stoichiometrically and yet there are really four.<sup>3</sup>

There is an obvious reason for this. The best results have been obtained when people have passed hydrogen chloride into dry ether, in which is dis-

<sup>1</sup> Dittrich: *J. prakt. Chem.*, (2) 18, 72 (1878).

<sup>2</sup> James: *J. prakt. Chem.*, 2, 31, 416 (1885).

<sup>3</sup> Bancroft and Barnett: *J. Phys. Chem.*, 34, 449 (1930).

solved the substance to be examined. In most cases these results are right; but many people have not made their experiments this way and there are possibilities of error even here. One of the hydrochlorides may be soluble in a solution of hydrogen chloride in ether or it is possible that hydrogen chloride in ether may decompose the compound more rapidly than would be the case with hydrogen chloride alone.

When we come to aqueous solutions of acid, the possible errors become real ones in many cases:

1. The acid solution may not be sufficiently concentrated.
2. The acid solution may dissolve the pure substance or some one of its hydrochlorides.
3. The acid solution may decompose the pure substance or one of its hydrochlorides.

The first error came up with tribromaniline hydrochloride. To get this as a solid phase, one must have approximately six-normal hydrochloric acid, which is a much more concentrated solution than one ordinarily uses. If one goes too much above that, the tribromaniline hydrochloride will dissolve in the concentrated acid.

In a great many cases we read that the substance dissolves in an acid solution and therefore forms a compound. Under these circumstances we do not know that a compound is formed or what its composition is if there is one. Aniline hydrochloride and tribromaniline hydrochloride dissolve in concentrated hydrochloric acid but that does not indicate the formation of a dihydrochloride.

Tetraphenyl hydrazine is decomposed even by hydrogen chloride in dry ether; but it does not necessarily follow that it would be decomposed by hydrogen chloride in the absence of ether. The difficulty in regard to decomposition becomes very serious with nitric acid, which has been used a good deal. With a dilute nitric acid solution, it is of course difficult to get many nitric acids added on stoichiometrically, and increasing the nitric acid concentration increases the danger of oxidation or nitration very much.

It will now be in order to see how well the generalizations enable us to account for the facts, real or imaginary. It will probably be easier to see the results if we deal first chiefly with substances containing one nitrogen in the formula, though not necessarily sticking to that too closely.

#### Substances containing One Nitrogen Atom

The mono-, di-, and tri-alkylamines add on one hydrogen chloride stoichiometrically. Owing to the substitution of hydrogen by alkyl groups, these amines are stronger bases than ammonia in the sense of being more highly dissociated electrolytically in aqueous solution.<sup>1</sup> According to Sidgwick,<sup>2</sup> "the alkylamine with the longest chain is heptadecylamine,  $C_{17}H_{35}NH_2$ . It

<sup>1</sup> Ostwald: *J. prakt. Chem.*, (2) 33, 352 (1886).

<sup>2</sup> "The Organic Chemistry of Nitrogen," 22 (1910); Meyer and Jacobson: "Lehrbuch der organischen Chemie," 1, 244 (1893).

melts at 40° and boils at 335°. It is as basic as the lower amines. Its alcoholic solution absorbs carbon dioxide from the air, and has a strong alkaline reaction. But its hydrochloride, though easily soluble in alcohol, is insoluble in water, whereas the hydrochlorides of the lower amines are deliquescent."

The tendency to form pentavalent nitrogen is so great that bromethylamine rearranges to form dimethylene imine hydrobromide. With H<sub>2</sub>SO<sub>4</sub> it goes to taurine and hydrogen bromide.<sup>1</sup> There seems to be some dispute as to the facts, because Sidgwick<sup>2</sup> says that ethylene imine adds on HCl to form chloroethylamine,

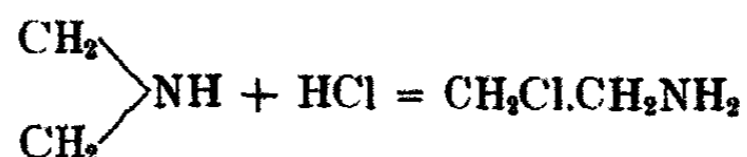

This again is a question of the conditions of the experiment.

Diacetonamine, triacetonamine, triacetonalkamine, and triacetonin each add on one hydrogen chloride stoichiometrically.<sup>3</sup> This covers quite a range of chemical characteristics. Diacetonamine is an open-chain compound, and shows by its reaction with nitrous acid that it is a primary amine. Triaceton-

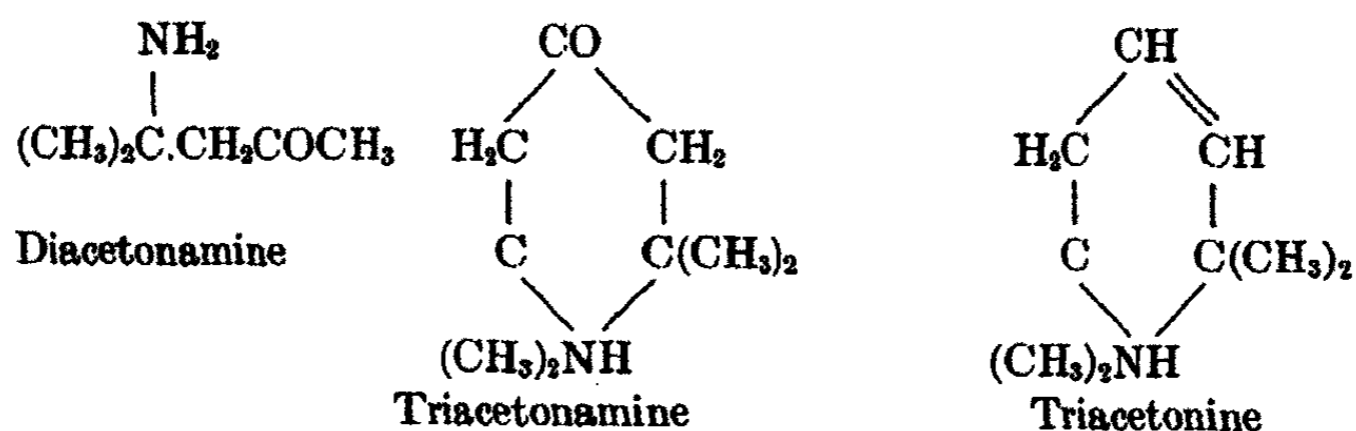

amine is a ring compound with five carbon atoms and one nitrogen atom in the ring. It belongs in the piperidine and pyridine group as do also triacetone alkamine and triacetonine.

Since the phenyl group is negative to hydrogen and to alkyl groups, we should expect the aromatic amines to be weaker bases than ammonia and still weaker than the corresponding alkylamines. This is the case experimentally. Aniline is a weaker base than ammonia and consequently a still weaker base than methyl or ethyl amine. The introduction of a second phenyl group would be expected to decrease the basicity, and diphenylamine is a much weaker base than aniline. It still forms salts with strong acids; but these salts are hydrolyzed so strongly that one cannot, for instance, recrystallize diphenylamine hydrochloride from water. One must have an excess of hydrochloric acid present if the hydrochloride is to crystallize.

Triphenylamine is still weaker and does not form a compound with hydrogen chloride at all. This substance has been rather a disappointment to us. It was all right for it not to react stoichiometrically with hydrogen chloride;

<sup>1</sup> Meyer and Jacobson: "Lehrbuch der organischen Chemie," 1 II, 251.

<sup>2</sup> "The Organic Chemistry of Nitrogen," 331 (1910).

<sup>3</sup> Meyer and Jacobson: "Lehrbuch der organischen Chemie," 1, 416 (1893).

but we expected that a relatively small increase in pressure or a lowering of the temperature would cause the formation of a definite compound. We ran the hydrogen chloride pressure up to two atmospheres, which was about all that the apparatus would stand, and carried the temperature down to about  $-30^{\circ}$  but all in vain. It still seems certain that triphenylamine will react stoichiometrically with hydrogen chloride at some pressure; but we do not at present know how to predict what that pressure will be.

Alkyl-substituted anilines are stronger bases than aniline, as they should be. If one adds methyl iodide to dimethyl aniline, we get trimethyl phenyl ammonium iodide,<sup>1</sup>  $C_6H_5.N(CH_3)_3I$ , which is not decomposed by cold, aqueous alkalies. Treatment with silver oxide sets free the corresponding, strongly caustic, ammonium base. If one heats the iodide in a current of hydrogen chloride, it decomposes into dimethyl aniline and methyl iodide. If one boils it for a long time with concentrated caustic potash, dimethyl aniline is also formed, along with methyl alcohol.

There are some rather interesting things about the formation and decomposition of dimethyl aniline,<sup>2</sup> which we have not yet been able to study; but which we hope to take up some day. "The introduction of alkyl radicals into the amido group of aniline can be done easily by treating aniline with the alkyl halides.<sup>3</sup> One obtains a mixture of unattacked aniline with mono-alkyl and di-alkyl aniline. The reaction runs like the one in which the alkyl halides react with ammonia. . . . The alkyl radicals of the alkyl-aryl amines can be split off again relatively easily as alkyl chlorides. If one heats dimethyl aniline to about  $180^{\circ}$  in a current of dry hydrogen chloride, first one methyl chloride and then another is split off, the final product being aniline hydrochloride."

It should apparently be possible to treat a primary alkyl or aryl amine with methyl chloride for instance and get an addition compound from which methyl chloride would dissociate; but which would change on heating to a compound from which hydrogen chloride would dissociate. If one could get addition compounds of methyl chloride with certain nitrogen bases, this would give us a gas which would not decompose gelatin, casein, and other proteins, and which would probably have quite other dissociation pressures from hydrogen chloride, thus enabling us to differentiate between nitrogen linkages in a new way.

Coming back to the official subject, the replacement of a phenyl group in aniline by a benzyl group should give something intermediate in basicity between aniline and methyl amine. This is already well known.<sup>4</sup>

"Aniline and its homologues, such as toluidine or amidotoluene, were classed as amines. They are, however, as different from these as phenols are from alcohols, and hence Griess<sup>5</sup> proposed to call them amido-compounds. They are only weak bases, although they combine readily with acids to form

<sup>1</sup> Meyer and Jacobson: "Lehrbuch der organischen Chemie," 2, 177 (1902).

<sup>2</sup> Meyer and Jacobson: "Lehrbuch der organischen Chemie," 2, 172 (1902).

<sup>3</sup> Hofmann: Ann., 74, 128 (1850); Ber., 10, 591 (1877).

<sup>4</sup> Roscoe and Schörllemmer: "A Treatise on Chemistry," 3 III, 2 (1887).

<sup>5</sup> Ann., 121, 258 (1862).

salts which crystallize easily but exhibit an acid reaction. On the other hand, benzylamine, an isomeride of toluidine, is a strong caustic liquid, miscible with water, possessing a powerful alkaline reaction, and rapidly absorbing carbon dioxide from the air. Aniline and its homologues, on the contrary, are only slightly soluble in water, possess an aromatic smell, exhibit no alkaline reaction, and do not form carbonates."

Laubenheimer<sup>1</sup> says that benzylamine is so like the alkyl amines in methods of preparation and in properties that nothing more need be said about it. He adds, however, that "it is worth noting that benzylamine, in contradistinction to toluidine is a strong base which absorbs carbon dioxide from the air and is converted into a crystalline carbonate."

The difference between benzylamine and aniline shows up in another way. Limpricht<sup>2</sup> reports that dibenzylamine hydrochloride and tribenzylamine hydrochloride crystallize easily from a hydrochloric acid solution, while triphenylamine hydrochloride has never been made. Wallach<sup>3</sup> has also made the tribenzylamine hydrobromide. Going down one step on the scale, Matsudaira<sup>4</sup> reports that dibenzylaniline is a weak base, whose salts are decomposed by water. There is nothing in that to show that dibenzylaniline is a weaker base than tribenzylamine; but that will certainly prove to be the case as soon as quantitative data are available.

Hofmann<sup>5</sup> has prepared a pentamethylaniline which combines with hydrogen iodide and Hodgkinson and Limpach<sup>6</sup> have made an ethyl dimethyl amido benzene, which combines with hydrogen chloride; but they give no measurements to show whether this is, as it should be, a stronger base than aniline. On the other hand Bredig<sup>7</sup> has found that p-toluidine is a good deal stronger base than aniline, m-toluidine a somewhat stronger base, and o-toluidine a somewhat weaker base. It would be interesting to know whether the same results would be obtained from a study of the dissociation pressures of the hydrochlorides.

If we hydrogenate the benzene ring we are getting back towards the aliphatic compounds and it is, therefore, quite natural to read<sup>8</sup> that "the amines of the cyclohexane series are usually oils with strongly basic properties, resembling those of the alkyl amines. They absorb carbon dioxide greedily from the air with formation of carbonates."

Indole is a weak base and forms, with concentrated hydrochloric acid, a sparingly soluble salt which is dissociated by boiling with water. The picrate is precipitated as dark red needles when a solution of indole in light petroleum is treated with picric acid.<sup>9</sup>

<sup>1</sup> "Grundzüge der organischen Chemie," 651 (1884).

<sup>2</sup> Ann., 144, 304 (1867).

<sup>3</sup> Ann., 259, 300 (1890).

<sup>4</sup> Ber., 20, 1611 (1887).

<sup>5</sup> Meyer and Jacobson: "Lehrbuch der organischen Chemie," 2, 219 (1902).

<sup>6</sup> J. Chem. Soc., 61, 420 (1892).

<sup>7</sup> Z. physik. Chem., 13, 322 (1894).

<sup>8</sup> Meyer and Jacobson: "Lehrbuch der organischen Chemie," 2, 790 (1902).

<sup>9</sup> Thorpe: "A Dictionary of Applied Chemistry," 3, 626 (1922).

Meyer and Jacobson<sup>1</sup> say that "the monohalogen derivatives of aniline form water-stable salts; the salt of the dihalogen derivatives with volatile mineral acids on the other hand decompose considerably while their aqueous solutions are being evaporated. The trihalogen derivatives<sup>2</sup> form no salts with aqueous acids."

The catch in the preceding paragraph is in the last two words. Gattermann obtained tribromaniline hydrochloride from a benzene solution and he did not realize that it must be possible also to get it from an aqueous solution, because the equilibrium between hydrogen chloride and solid tribromaniline to form solid tribromaniline hydrochloride must be independent of the nature of the solvent. That was shown by Gibbs over fifty years ago.

Jackson and Gallivan<sup>3</sup> have shown that the 1.2.4.5 and 1.3.4.5 tribromaniline are stronger bases than the 1.2.4.6 tribromaniline, which is the one that is obtained by brominating aniline hydrochloride.

If we change from aniline to benzylamine, we increase the basicity or decrease the acidity and, consequently, it is not surprising to find reported<sup>4</sup> a hydrochloride of trichlorbenzylamine.

Laubenheimer<sup>5</sup> points out that the heat of neutralization is one measure of the strength of a base and that the heats of neutralization by hydrochloric acid are:—

Aniline	+7440 cal
Metachloraniline	+7198 cal
Parachloraniline	+6606 cal
Orthochloraniline	+6274 cal

From this it follows that metachloraniline is the strongest of the three bases and orthochloraniline the weakest. What one should do now is to make comparative measurements of the dissociation pressures of the three hydrochlorides at different pressures. From the electrolytic dissociation theory we know that the heats of neutralization of the orthochloraniline hydrochlorides, hydrobromides, and hydriodides, for instance, would be practically equal, whereas there is nothing to show that this would be true for the dissociation pressures of the solids in the absence of water. In fact, all the indirect evidence is that there would be marked differences.

Laubenheimer<sup>6</sup> also points out that "in consequence of the acidifying action of the nitro group, the nitrated amines resemble the acid amides to some extent in their chemical behavior. Here we find, as in the preceding paragraph, that the effect of the nitro group is strongest when it is in the ortho position to the amide group and weakest when it is in the meta position. The acidifying action of the nitro group is much greater than that of a halogen

<sup>1</sup> Meyer and Jacobson: "Lehrbuch der organischen Chemie," 2, 209 (1902).

<sup>2</sup> Gattermann: Ber., 16, 634 (1883).

<sup>3</sup> Berlin: Ann., 151, 137 (1869).

<sup>4</sup> Am. Chem. J., 18, 248 (1896); 20, 180 (1898).

<sup>5</sup> "Grundzüge der organischen Chemie," 436 (1884).

<sup>6</sup> "Grundzüge der organischen Chemie," 662 (1884).

atom. Even in the mononitro derivatives of the amines the basic character has nearly disappeared. While the mononitranilines do form salts with strong acids, these salts are hydrolyzed to some extent by water. The di- and trinitranilines have no basic properties whatsoever. . . . These nitrated amines are more stable against ethyl nitrite the greater the effect of the nitro group on the amido group. While the mononitranilines and the 2,4-dinitraniline react fairly readily with ethyl nitrite to form mono- and dinitrobenzene respectively, ethyl nitrite reacts with 2,6-dinitraniline only when heated to about 120° and does not react with trinitraniline even at 160°."

It has already been pointed out that tribenzylamine adds hydrogen chloride. Since the nitro group has a strong acidifying effect, it is not surprising to find that mononitrodibenzylaniline does not add on hydrogen chloride. Matsudaira<sup>1</sup> reports that it does not function at all as a base, not forming salts with acids or double salts with platinum chloride. Nitroso dibenzyl aniline is also apparently over the line, though no experiments were tried with ether and hydrogen chloride. On the other hand mononitraniline combines stoichiometrically<sup>2</sup> with one hydrogen chloride. Lellmann noticed that the three hydrochlorides decomposed at different rates in moist air, the ortho compound apparently decomposing the most readily and the meta compound the least readily. The extent of the hydrolysis was estimated from the yellow color due to the base, the salts being almost colorless.

This was so qualitative that other experiments were started. "I have subjected this process of the decomposition of the nitraniline hydrochlorides by water to a quantitative study. The hydrochlorides were prepared by leading dried hydrogen chloride into solutions of the nitranilines in dry benzene, filtering when the voluminous precipitate seemed not to be increasing, washed with benzene, and dried in a vacuum [degree of vacuum not stated]. Meta-nitraniline hydrochloride was obtained in this way as a pure white mass, while the ortho compound was slightly yellowish, and the para compound had a touch of gray in it.

"The action of water on these hydrochlorides was now studied under two sets of conditions. First the same amounts of each hydrochloride (0.6504g) were placed in crucibles of practically identical size, together with the same amounts of water (9 cc), and the crucibles were placed in a tight-closing bell-jar and left there for eight days. At the end of that time the three crucibles were placed in another bell-jar which contained concentrated sulphuric acid and solid sodium hydroxide. After fourteen days of this, all the water and all the liberated hydrogen chloride were absorbed and chlorine determinations showed that the following amounts of the hydrochlorides had been converted into base and acid:—

<i>o</i> -nitraniline hydrochloride	9.64%
<i>p</i> -nitraniline hydrochloride	5.21%
<i>m</i> -nitraniline hydrochloride	0.84%

<sup>1</sup> Ber., 20, 1614 (1887).

<sup>2</sup> Lellmann: Ber., 17, 2719 (1884).



It follows from this that a partial decomposition into acid and base occurred in all three cases; but that the decomposition of the meta compound was so slight as not to exceed the experimental error by much. The conditions in a second run were, therefore, so chosen that the effect of the water was much greater. Equal quantities (0.5171g) of the hydrochlorides were placed in equal-sized flasks with the same amounts of water (27 cc) and the solutions were heated for a short time to incipient boiling, on a uniformly heated sand-bath. They were then evaporated to dryness in an oven held at 75°. The percentage decompositions came out:—

<i>o</i> -nitraniline hydrochloride	63.8%
<i>p</i> -nitraniline hydrochloride	13.1%
<i>m</i> -nitraniline hydrochloride	3.4%

"The order of decomposition is the same in the two runs. The meta compound is the most stable and the ortho compound the least stable.

"If one compares the behavior of the three nitraniline hydrochlorides with that of aniline hydrochloride, which is not decomposed by water, it appears that the introduction of the nitro group in the meta position weakens the basic character the least, while substitution in the para position has more effect, and substitution in the ortho position has a considerable effect. In other words, the nitro group, without being changed itself, gives the nitraniline hydrochloride a power to react [in the way of splitting off hydrochloric acid by water] which aniline hydrochloride does not have. The increased reactivity is greatest when the nitro group is in the ortho position and least when it is in the meta position."

These figures cannot be anything but qualitative. If, however, one were to measure the dissociation pressures of these three hydrochlorides, one could get data which could be translated at once into work units, as van't Hoff has done in the case of hydrated salts. These results would be independent of the nature of the solvent and would therefore be better adapted for comparison.

Since nitrodibenzylamine does not add on hydrogen chloride, it follows that the more negative compound nitro diphenyl amine will not and one cannot even guess what pressure of hydrogen chloride would be necessary to make such a compound as hexanitro diphenylamine<sup>1</sup> add on hydrogen chloride stoichiometrically.

The nitroso group would be expected to be less acidifying than the nitro group, and consequently it is not surprising to find that *p*-nitroso-aniline hydrochloride<sup>2</sup> can be recrystallized unchanged from water, which was not possible with *p*-nitraniline hydrochloride. A stronger base and one more familiar to physical chemists is *p*-nitrosodimethylaniline.

The amidophenols are phenols and are weak bases, but form definite chemical compounds with strong acids; their halogen-substitution products behave like phenol, the acid character increasing with the number of hydrogen

<sup>1</sup> Gnehm: Ber., 7, 1399 (1874).

<sup>2</sup> Meyer and Jacobson: "Lehrbuch der organischen Chemie," 2, 394 (1902).

atoms replaced. The replacement of hydrogen by nitroxyl acts still more strongly in this way.<sup>1</sup> The hydrochloride of ortho-amidophenol is readily soluble in water and crystallizes in long needles. Metamidophenol is not known in the free state, as it is a very unstable substance. Its hydrochloride is obtained by the reduction of metanitrophenol with tin and hydrochloric acid; it forms hard, colorless granules, an aqueous solution of which soon decomposes and becomes brown. The hydrochloride of paramidophenol crystallizes in prisms which dissolve readily in water, forming a solution which is colored first violet and then green by bleaching powder.

"Trimethylortho-amidophenol or trimethyl hydroxylammonium hydroxide,  $\text{HO.C}_6\text{H}_4\text{N(CH}_3)_3\text{OH}$ , is obtained by treating a solution of orthoamidophenol hydrochloride in methyl alcohol with three parts of methyl iodide, adding a considerable excess of caustic potash and allowing the whole to stand, with repeated additions of potash, until an acid reaction is no longer produced.<sup>2</sup> The hydriodide thus obtained is decomposed by freshly precipitated silver oxide. The base is readily soluble in water and alcohol, but not in ether, and crystallizes in white prisms which have an intensely bitter taste. On heating

to  $105^\circ$  it forms the anhydride:  $\text{C}_6\text{H}_4\text{N(CH}_3)_3$ ." 

Phenyl amido-oxybenzene,  $\text{HO.C}_6\text{H}_4\text{NH.C}_6\text{H}_5$ , is said to be a weak base and to form salts<sup>3</sup> with strong acids. This is not surprising, because this compound can only be a trifle less basic than diphenylamine which everybody knows forms salts. Stuckenberg<sup>4</sup> quotes Petersen to the effect that picramic acid,  $\text{C}_6\text{H}_2(\text{NO}_2)_2\text{NH}_2(\text{OH})$ , adds one hydrogen chloride. It is not clear why this should be. Dinitraniline will not add hydrogen chloride and one would expect the introduction of the hydroxyl group to decrease the basicity rather than to increase it. The statement seems to be confirmed.<sup>5</sup>

"Cahours prepared methyl picramate,  $\text{C}_6\text{H}_2(\text{NO}_2)_2\text{NH}_2(\text{OCH}_3)$ , by the action of alcoholic ammonium sulphide on methyl picrate. It crystallizes from hot alcoholic in dark violet needles and, like picramic acid, combines with acids to form unstable salts."

There is no difficulty about methyl picramate because the methoxyl group is known to be positive and might overcome the effect of the second nitro group. The experiments with picramic acid certainly should be repeated, because there is apparently something wrong about them.

Bromo-amido salicylic acid combines stoichiometrically<sup>6</sup> with hydrogen chloride. This is another case which one would expect to be over the border line rather than on it. Salicylic acid ( $K = 0.102$ ) is a much stronger acid than benzoic acid ( $K = 0.006$ ), and the introduction must make the compound

<sup>1</sup> Roscoe and Schörlammer: "A Treatise on Chemistry," 3 III, 247 (1887).

<sup>2</sup> Griess: Ber., 13, 246 (1880).

<sup>3</sup> Meyer and Jacobson: "Lehrbuch der organischen Chemie," 2, 394 (1902).

<sup>4</sup> Ber., 10, 384 (1877).

<sup>5</sup> Roscoe and Schörlammer: "A Treatise on Chemistry," 3 III, 250 (1887).

<sup>6</sup> Lellmann and Grothmann: Ber., 17, 274 (1884).

more acid. Evidently, however, the three groups together are not equal to two nitro groups. If we had dissociation pressure measurements we could evaluate these effects quantitatively instead of qualitatively as now.

In choline the nitrogen is already pentavalent,  $(\text{CH}_3)_3\text{N}(\text{OH})\cdot\text{CH}_2\text{CH}_2\text{OH}$  so we do not have to worry about that. As a tetra-alkyl ammonium hydroxide it is a strong base. Betaine is like choline. As has already been pointed out, amido-ethyl sulphonic acid occurs as an intramolecular salt, taurine,  $\text{NH}_3\cdot\text{CH}_2\text{CH}_2\cdot\text{SO}_3$ . It does not add on hydrogen chloride. Hippuric acid,  $\text{C}_6\text{H}_5\cdot\text{CO}\cdot\text{NH}\cdot\text{CH}_2\cdot\text{CO}_2\text{H}$ , was found not to add on hydrogen chloride. The only apparent way in which we could account for this was that hippuric acid, which is quite a strong acid, formed an intramolecular salt, analogous to taurine. If this were the case ethyl hippurate should add on one hydrogen

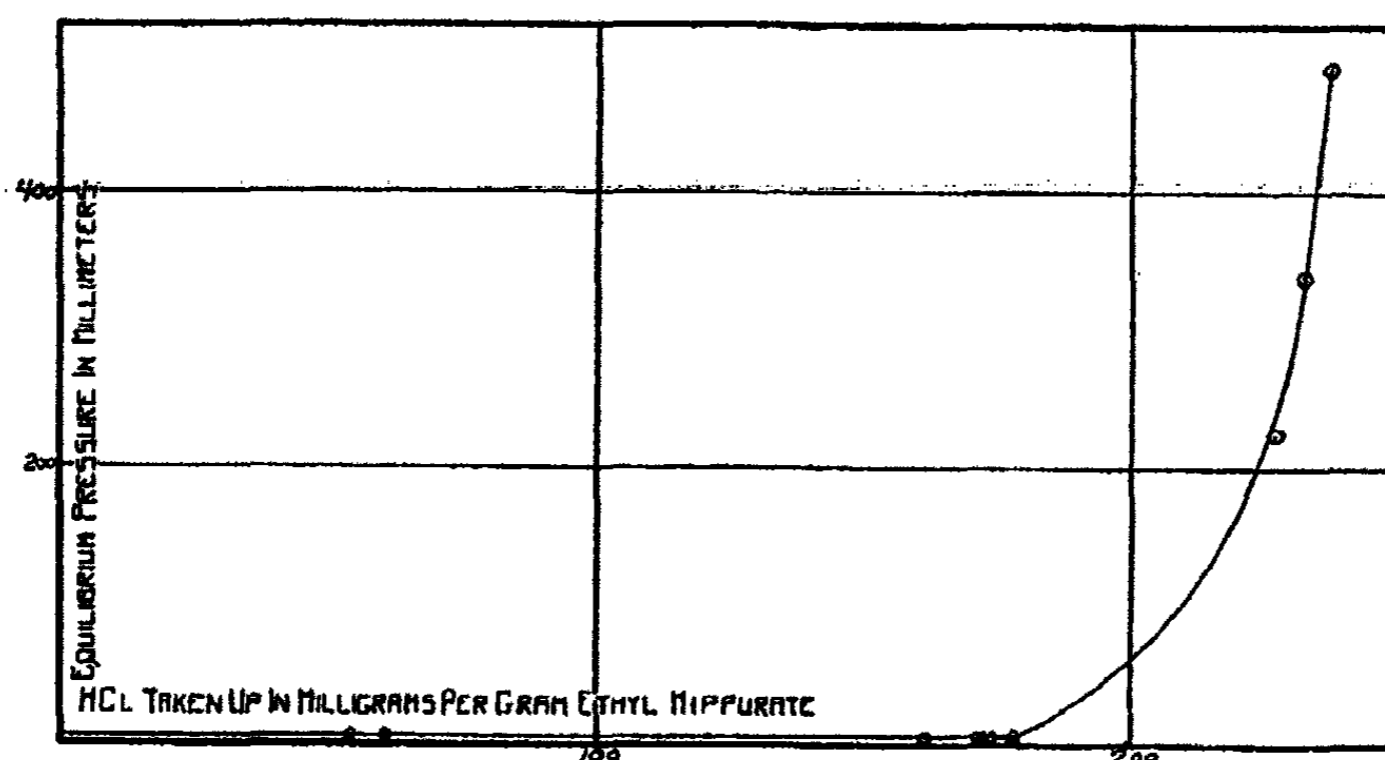

FIG. 2

chloride stoichiometrically. On trying the experiment the prediction was verified. The results are shown in Fig. 2. Sulphanilic acid is probably another case; but we have not tested it.

Oxyethyl, dioxyethyl amine, and trioxyethylamine add one hydrogen chloride apiece. Glycine adds on hydrogen chloride and so do all the normal amino-acids, such as p-amino benzoic acid, glutamic acid, etc.

"The pyridine bases are tertiary amines which form well-characterized salts with one equivalent of acid. They combine with one mol methyl iodide, ethyl iodide, etc., to form iodides of ammonium bases, from which the strongly basic ammonium hydroxides can be set free by treatment with water and silver oxide! . . . The carboxyl derivatives of the pyridine bases are obtained by oxidation of homologues of pyridine, a reaction which is analogous to the conversion of the homologues of benzene into acids of the benzoic acid type. Di- and tricarboxylic acids are obtained by oxidation from the quinoline group and from such alkaloids as quinine and cinchonine, which contain the quino-

<sup>1</sup> Laubenheimer: "Grundzüge der organischen Chemie," 825, 827, 833 (1884).

line nucleus. The typical reaction of this sort is the formation of quinolinic acid (pyridine dicarboxylic acid) from quinoline which is analogous to the formation of phthalic acid from naphthalene.

"These acids react with bases to form well-characterized salts and usually combine also with acids. In the case of the polybasic acids, the presence of several acid carboxyl groups weaken the tendency to combine with acids, and the basic properties are entirely lost in the case of pyridine pentacarboxylic acid, which is a very strong acid and does not combine at all with hydrochloric acid and which even precipitates a barium chloride solution."

"Quinoline is a strong tertiary base. With alkyl halides,  $C_xH_y.X$ , it forms addition products,  $C_9H_7N.C_xH_yX$ , from which moist silver oxide, caustic potash, or ammonia splits off the halide acid and precipitates the alkyl-substituted quinoline,  $C_9H_6N C_xH_y$ , whose halide salts are identical with the original addition products. . . .

"It is to be noted that in the halogen-substituted quinolines the tendency of the halogen atoms to react varies very much with their position relatively to the nitrogen atom. If the halogen is in the alpha-position and the compound, therefore, contains the atomic grouping  $-N:CX.$ , the halogen is easily replaced by other atoms or radicals. This carbostyryl,  $C_9H_6(OH)N$ , is formed merely by heating  $\alpha$ -chloroquinoline with water. In other cases the chlorine is held with about the same firmness as in the corresponding benzene compounds."

Mononitroquinoline has strongly basic properties. Dinitroquinoline and  $\alpha$ - and  $\beta$ -quinoline sulphuric acids apparently do not form salts with acids though this is not definitely so stated. The oxy-derivatives of quinoline behave in many respects like the phenols. As tertiary bases they combine with bases; but the dioxyquinolines are only slightly basic and their hydrochlorides are hydrolyzed by water.

Pyrrol is a weak base and has a tendency to polymerize in presence of acids. Dennstedt<sup>1</sup> obtained  $(C_4H_5N)_2HCl$  and  $(C_4H_5N)_3HCl$  by passing hydrogen chloride into a solution of pyrrol in ether. Ciamician and Zanetti<sup>2</sup> worked at  $-18^\circ$  and obtained true pyrrol addition compounds with only slight polymerization.  $\alpha\alpha'$ -dimethyl- $\beta$ -acetyl pyrrol and  $\alpha\alpha'$ -dimethyl- $\beta\beta'$ -diacetyl pyrrol each add one hydrogen chloride.

Naphthylamine forms a hydrochloride and anthramine is a very weak base. Methyl ketol is a weak base, while hydromethyl ketol is a stronger one,<sup>3</sup> just as it should be. Meta-amido acetophenone,  $C_6H_4NH_2(COCH_3)$  is of course a base and acetophenone anilide,  $C_6H_5.CO.CH_2.NHC_6H_5$ , is a weak one.

We have compiled a partial list<sup>4</sup> of alkaloids which contain one nitrogen atom and add on one hydrogen chloride. Trigonelline is the betaine of nicotinic acid and the nitrogen is therefore already pentavalent. Anhalamine, anhalodine, anhalonine, arecolidine, areoline, berberine, betonicine, cocaine,

<sup>1</sup> Ber., 20, 856 (1887); 21, 3429 (1888).

<sup>2</sup> Ber., 26, 1711 (1903).

<sup>3</sup> Laubenheimer: "Grundzüge der organischen Chemie," 690 (1884).

<sup>4</sup> Henry: "The Plant Alkaloids" (1924).

codeine, conhydrine, coniceine, coniine, corydaline, coriine, dioscorine, ephedrine, gavacine, gavacoline, hordenine, hydrastine, hydrastinine, hygrine, hyoscine (scopolamine), isotropine, lopophorine, mezacaline, morphine, narcotine, papaveine, paracurarine, pelletierine, pelletine, piperine, proto-curarine, stachhydrine, thebaine, turacine. This list makes no pretense at being exhaustive; but it is sufficient to show that the mono-nitrogen alkaloids are normal in the sense that we are using the term.

Owing to the keto linkage, acetamide is a weaker base than ethyl amine. It does add on hydrogen chloride, though this salt is hydrolyzed by water. This can lose hydrogen chloride, forming a compound with the formula<sup>1</sup>  $(\text{CH}_3\text{CONH}_2)_2\cdot\text{HCl}$ . What its structure formula is is not known definitely; but that is immaterial so far as we are concerned. The alkyl-substituted acetamides<sup>2</sup> are, of course, more strongly basic.

Diacetamide<sup>3</sup> does not add on hydrogen chloride because of the diketo linkage, and triacetamide<sup>4</sup> is of course more negative. "Diacetamide is distinguished from acetamide by not possessing basic properties, but acting as a weak acid, turning blue litmus red, and forming a silver salt which has not been specially examined. . . . Triacetamide crystallizes from ether in small elastic needles, which melt at  $78^\circ$ - $79^\circ$ , are odourless, possess a perfectly neutral reaction, and do not exhibit any basicity. This is easily explained, inasmuch as the basic character of the ammonia is altogether destroyed by the replacement of the three hydrogens by the three acid radicals. It however does not possess the character of an acid, because it does not contain any hydrogen replaceable by a metal, whilst diacetamide is a stronger acid than acetamide." Wichelhaus says that triacetamide behaves like an acid anhydride.

Chloethyl acetamide,  $\text{CH}_3\text{CONCl}(\text{C}_2\text{H}_5)$ , is a neutral, mobile liquid and does not add on hydrogen chloride. Benzamide,  $\text{C}_6\text{H}_5\text{CONH}_2$ , comes in between acetamide and diacetamide. It combines with hydrogen chloride to form a salt which is strongly hydrolyzed by water. Dibenzamide and tribenzamide and tribenzamide are more negative than diacetamide and triacetamide respectively, and do not either of them combine stoichiometrically with hydrogen chloride. Acetanilide is a weak base but does combine with hydrogen chloride, while diacetanilide,<sup>5</sup> with the diketo linkage, does not. Nothing is said<sup>6</sup> about acetyl diphenylamine; but we can be pretty certain that it does not. We could not find any statement in the literature either way as to a hydrochloride of benzanilide, so we tested it ourselves and found that a definite hydrochloride is formed, Fig. 3. Phenacetin,  $\text{CH}_3\text{CH}_2\text{O C}_6\text{H}_4\cdot\text{NH}\cdot\text{COCH}_3$ , should be at least as positive as acetanilide and therefore must add on hydrogen chloride, though Meyer and Jacobson<sup>7</sup> do not mention

<sup>1</sup> Pinner and Klein: Ber., 10, 1896 (1877).

<sup>2</sup> Wallach: Ann., 214, 340 (1882); Wallach and Lehmann: 237, 239 (1887).

<sup>3</sup> Hentschel: Ber., 23, 2399 (1890); Rosecoe and Schorlemmer: "A Treatise on Chemistry," 3 I, 519 (1886).

<sup>4</sup> Wichelhaus: Ber., 3, 847 (1870).

<sup>5</sup> Tassinari: Gazz., 24 I, 61 (1894).

<sup>6</sup> Merz and Weith: Ber., 6, 1511 (1873); Claus: 14, 2366 (1881).

<sup>7</sup> "Lehrbuch der organischen Chemie," 2, 393 (1902).

the fact. Acetylglycine adds on hydrogen chloride. It is sometimes called aceturic acid.

The amides of the oxyacids, such as glycolamide, are weak bases; but the hydroxyl is too far from the nitrogen to have much effect. These substances are isomeric with the amido acids.

Since piling up acetyl groups makes a compound more acid, one would expect that increasing the anilide groups would eventually make it possible for one of the nitrogens to react with hydrogen chloride. Zincke<sup>1</sup> reports on a case of this sort. Anilido-toluquinone has no basic properties; dianilido-toluquinone has no marked basic properties; and trianilido-toluquinone forms well-characterized salts with acids, the salts not being decomposed by water. It is a monacid base. Anilido-ethoxyquinone is quite a strong base.

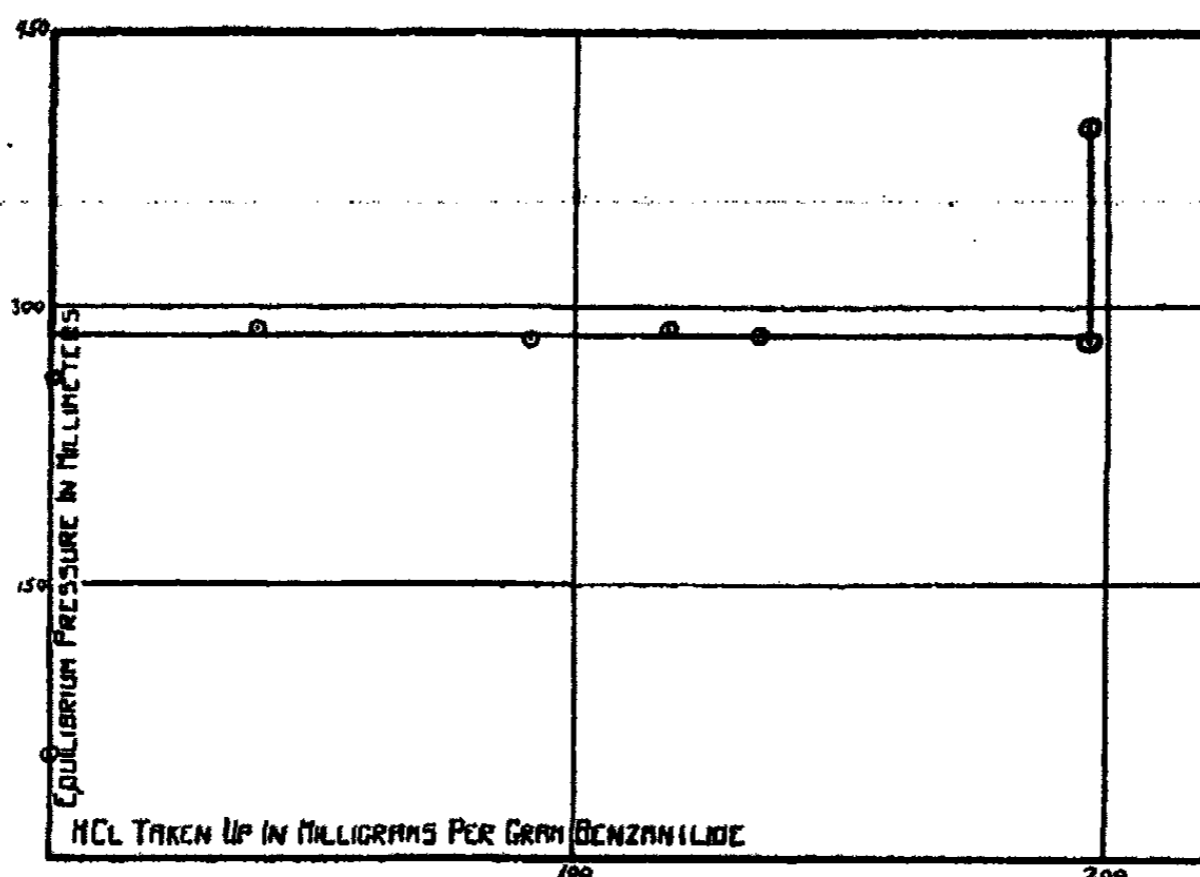

FIG. 3

The ethylester of glycine adds on hydrogen chloride.<sup>2</sup> Trimethyl glycine is betaine in which the nitrogen is already pentavalent; but the acid radical is weak enough so that a hydrochloride is formed, which is not the case with hippuric acid or with taurine.

The imido-ethers,  $\text{HN:C.R(OR)}$ , add on one hydrogen chloride, as they should, and it is even possible to get, temporarily, the hydrochloride<sup>3</sup> of a chloramido ether,  $\text{CH}_3\text{C(NH}_2\text{)Cl)OC}_2\text{H}_5$ . This goes over readily into the hydrochloride of the imido-ethers, just mentioned; in this case  $\text{CH}_3\text{C(NH)C}_2\text{H}_5$ . One can also get the hydrochloride of benzimido ethyl ether. We have found no statement as to acethydroxamic acid,  $\text{CH}_3\text{C.OH(NOH)}$ ; but the corresponding benzhydroxamic acid is over the line, and the dibenzhydroxamic acid still more so. Succinimide and phthalimide have the diketo

<sup>1</sup> Ber., 16, 1556 (1883).

<sup>2</sup> Meyer and Jacobson: "Lehrbuch der organischen Chemie," 1, 832 (1893).

<sup>3</sup> Meyer and Jacobson: "Lehrbuch der organischen Chemie," 1, 374 (1893).

linkage and do not add hydrogen chloride. In phthalimidine one of the oxygens has been replaced by two hydrogens and we get a weak base. A reduction product of succinimide is pyrrolidine which is a stronger base than pyrrol.

Hydroxylamine forms a hydrochloride, as everybody knows. Sidgwick<sup>1</sup> takes up the oxygen compounds in a somewhat different order from what one might expect; but it will simplify matters to follow him.

"The oxyamines have not been obtained in the anhydrous state. They separate from water in the form of hygroscopic crystals of a hydrate, e.g.  $(\text{CH}_3)_3\text{N}\cdot\text{O}\cdot 2\text{H}_2\text{O}$ , which retains its water of crystallization with great firmness. The solution has a strong alkaline reaction, and it does not reduce Fehling's solution, showing that the body is not a true hydroxylamine derivative. When treated with acid, it gives a salt such as  $(\text{CH}_3)_3\text{NOH}(\text{I})$ , so that it behaves as if one of the molecules of water was chemically bound to form a dihydroxy-compound,  $(\text{CH}_3)_3\text{N}(\text{OH})_2$ . Similarly it combines with methyl iodide to give the ether-salt  $(\text{CH}_3)_3\text{NOCH}_3(\text{I})$ .

"An analogous series of compounds are the oxides of the aromatic amines, prepared by Bamberger by direct oxidation. They are formed almost quantitatively from any testing mixed amines, such as dimethyl aniline, dimethyl toluidine, etc., by treatment with hydrogen peroxide or Caro's acid. They are crystalline compounds<sup>1</sup> ( $\varphi\text{N}(\text{CH}_3)_2:\text{O}$  melts at  $152^\circ$ ), which are excessively hygroscopic, but apparently do not form definite hydrates. When heated above their melting-points, they break up mainly into tertiary bases and oxygen. They have an alkaline reaction and form salts<sup>2</sup> with acids."

"The hydroxamic acids are related to the amides as hydroxylamine to ammonia, and like the amides they have two possible formulas:—



"The alkyl hydroxamic acids are neutral, while the aromatic acids have an acid reaction. . . . The chloride of formhydroxamic acid,  $\text{H}\cdot\text{C}:\text{NOH}(\text{Cl})$ , also known as formyl chloride oxime, is closely related to fulminic acid, from which it can be obtained by the action of hydrochloric acid and into which it is very easily converted:—



Diacethydroxamic acid,  $\text{CH}_3\text{C}(\text{OH}):\text{NO}\cdot\text{COCH}_3$ , obtained from hydroxylamine hydrochloride and acetic anhydride is a strong acid readily hydrolyzed by excess of alkali to acethydroxamic acid."

"The oximes are at once feebly basic and feebly acidic. They dissolve in alkalis and also form salts in ethereal solutions with mineral acids. They are, however, only in a secondary sense amphoteric electrolytes. The hydro-

<sup>1</sup> Sidgwick: "The Organic Chemistry of Nitrogen," 101, 103, 107 (1910).

<sup>2</sup> [Sidgwick uses  $\varphi$  as an abbreviation for phenyl.]

<sup>3</sup> Similar compounds can be prepared from the leuco-bases of the triphenyl methane dyes, such as malachite green and crystal violet. Bamberger and Rudolf: Ber., 41, 3290 (1908).

gen ion to which the acidic properties are due is derived directly from the oxime:—  $R_2C:NOH \rightleftharpoons R_2C:NO' + H'$ , while the basic properties are due to the nitrogen becoming pentad, as in salt  $R_2C:NH(OH).HCl$ ."

The acetaldoximes and the benzaldoximes add on hydrogen chloride stoichiometrically. Hydrochlorides are known of methoxylamine, and triethyl hydroxylamine.<sup>1</sup>

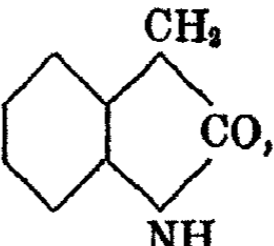
According to Sidgwick,<sup>2</sup> "Oxindol, or  $\alpha$ -indolinone, , melts

at 120°. It is the lactame of *o*-amino-phenyl-acetic acid, into the barium salt of which it is converted by heating with baryta to 150°. So great is the tendency to close the ring that the free acid is incapable of existence: if the barium salt is treated with acid the oxindol is formed at once. . . .

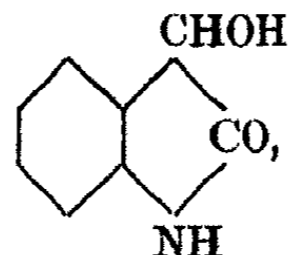
"Dioxindol, , is the lactame of *o*-amino-mandelic acid,

which can also exist only in the form of its salts, and passes over into the lactame as soon as set free. . . .

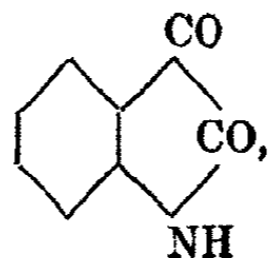
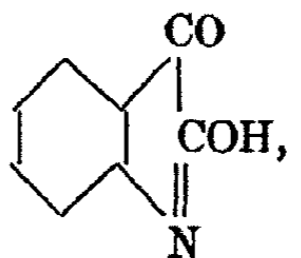
"Isatin is the lactame, , or lactime, , of

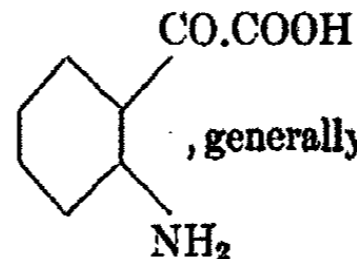
*o*-amino-benzoyl formic acid, , generally known as isatic acid, which

can be isolated, but goes over into isatin if warmed in aqueous solution.

Sidgwick does not mention the basicity; but Laubenheimer<sup>3</sup> says that oxindol and dioxindol form compounds with acids. Isatin should do the same and therefore probably does.

The hydrochloride of phenyl carbimide,  $C_6H_5N:C:O$ , is obtained<sup>4</sup> by passing hydrogen chloride through pure phenyl isocyanate, heat being evolved.

<sup>1</sup> Meyer and Jacobson: "Lehrbuch der organischen Chemie," 1, 250 (1893).

<sup>2</sup> "The Organic Chemistry of Nitrogen," 371 (1910).

<sup>3</sup> "Die Grundzüge der organischen Chemie," 694 (1884).

<sup>4</sup> Roscoe and Schorlemmer: "A Treatise on Chemistry," 3 III, 219 (1887).



Under the generalizations earlier in this paper, it was stated (No. VI) that hydrogen chloride does not add directly to the nitrogen in the case of nitriles and isonitriles. That appears to be contradicted by the statement<sup>1</sup> that the isonitriles or carbylamines are basic liquids which combine with hydrogen chloride in ethereal solution to give such compounds as  $2\text{CH}_3.\text{NC}.\text{3HCl}$ , for instance, where there is more hydrogen chloride than there are nitrogens, an apparently unpardonable thing. The answer is that the first addition of hydrogen chloride is not to the nitrogen. According to the way one writes the formula, the equation is

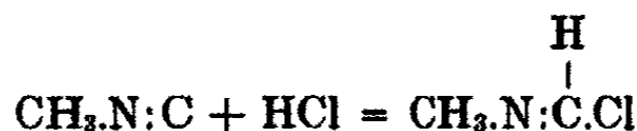

How the third hydrogen chloride shall be added depends on what assumption one makes as to the polymerized carbylamine.

In the same way phenyl carbylamine,  $\text{C}_6\text{H}_5.\text{NC}$  adds on hydrogen chloride<sup>2</sup> to form hydrochloride of phenylimido formyl chloride,  $(\text{C}_6\text{H}_5.\text{NCHCl})_2.\text{HCl}$ .

Meyer and Jacobson<sup>3</sup> say in regard to the nitriles: "In naming the compounds which are formed when an alkyl radical combines with the cyanogen group, one may either emphasize the relation to the alcohols or to the carboxyl acids. If we consider them as derivatives of the alcohols, we shall call them alkyl cyanides and the compound  $\text{CH}_3.\text{CN}$  will be methyl cyanide. If, on the other hand, we consider them as nitriles of the fatty acids, then one classes as nitriles those derivatives of acids which have the cyanide group  $-\text{CN}$  in place of the carboxyl group  $-\text{CO}_2\text{H}$ . Methyl cyanide  $\text{CH}_3.\text{CN}$  is then the nitrile of acetic acid and may be called acetoneitrile, ethyl cyanide  $\text{C}_2\text{H}_5.\text{CN}$  is propionitrile, etc.

"If one is considering these compounds as nitriles, the first term in the series is hydrocyanic or prussic acid  $\text{H}.\text{C}:\text{N}$ , which is the nitrile of formic acid. If one considers these compounds as alkyl cyanides, the series begins with methyl cyanide or acetoneitrile,  $\text{CH}_3.\text{CN}$ . In this chapter the latter point of view will be adopted and we shall discuss only acetoneitrile and its homologues. Prussic acid will be treated later, along with the other cyanogen compounds."

"Hydrogen chloride combines with the nitriles to give compounds which may be classed as imide chlorides:—

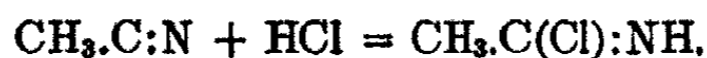

If one passes hydrogen chloride into a mixture of a nitrile and an alcohol, one gets the hydrochloride of an imido-ether:—



<sup>1</sup> Meyer and Jacobson: "Lehrbuch der organischen Chemie," 1, 258 (1893).

<sup>2</sup> Meyer and Jacobson: "Lehrbuch der organischen Chemie," 2, 194 (1902).

<sup>3</sup> "Lehrbuch der organischen Chemie," 1, 292, 297 (1893).

"While hydrogen chloride combines with the nitriles in the molecular ratio of one to one, two molecules of hydrogen bromide are fixed by one of the nitrile with equal ease:—

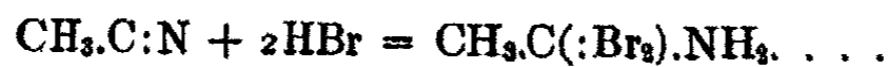

"Of special interest are the reactions, studied and explained chiefly by E. von Meyer, in which several molecules of the nitriles combine. We may have two nitrile molecules combining:

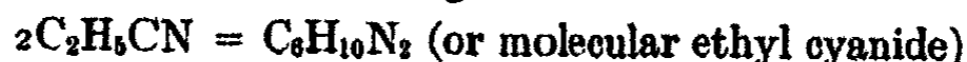

or three nitrile molecules combining.



Also different kinds of nitrile molecules may combine:—



The bimolecular nitriles are indifferent and the trimolecular nitriles are strongly basic substances.

"The formation of these bimolecular and trimolecular compounds occurs through the action of sodium on the alkyl cyanides. The bimolecular compounds are formed when the reaction takes place in presence of absolute ether. The trimolecular compounds, which have been known much longer, are formed when the dry alkyl cyanides are brought in contact with metallic sodium. . . .

"The bimolecular nitriles are to be considered as imidonitriles of keto acids, the bimolecular ethyl cyanide being then the nitrile

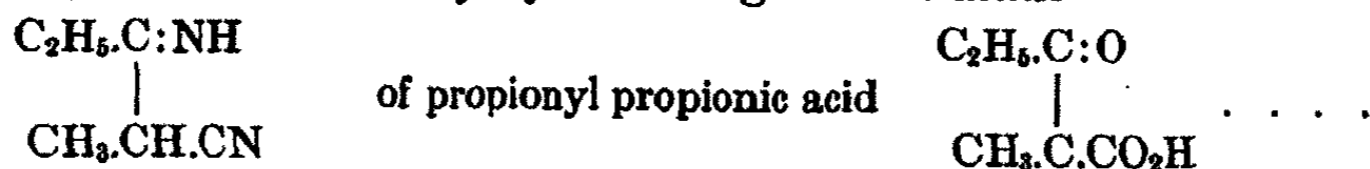

The trimolecular nitriles, the alkine cyanides, are derivatives of pyrimidine; the molecule contains a ring consisting of four carbon atoms and two nitrogen atoms.

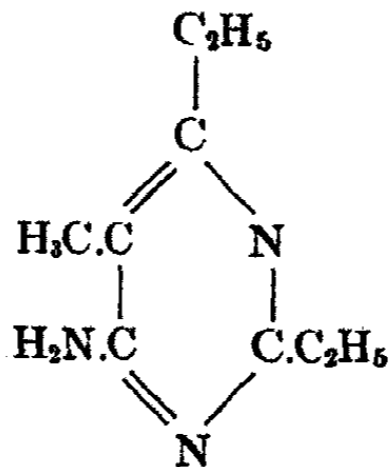

The bimolecular nitrile could conceivably add three hydrogen chlorides to give

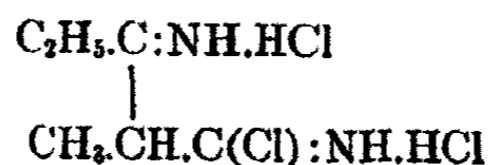

and this appears to have been realized experimentally.<sup>1</sup>

<sup>1</sup> Roscoe and Schorlemmer: "A Treatise on Chemistry," 3 I, 414 (1886).

"Anhydrous hydrochloric or hydrobromic acid is absorbed [by ethyl carbamate] with such avidity that a tarry mass is formed. In presence of ether the salts of ethylcarbamine are obtained, of which the hydrochloride<sup>1</sup> possesses the composition  $(\text{CN.C}_2\text{H}_5)_2(\text{HCl})_3$ ."

The trimolecular nitrile should only add two hydrogen chlorides, because there are two nitrogens attached to one carbon and consequently only one will react. According to Roscoe and Schorlemmer<sup>2</sup> cyanmethine or trimethyl cyanuride is a monacid base. If the hydrogen chloride added to the middle nitrogen, that would cut out both the other nitrogens because each is attached to a carbon to which the first nitrogen is attached. The statement in Roscoe and Schorlemmer may be due to experimental error. If not, we are dealing with a case covered by generalization No. VIII.

Another possibility is suggested by the work of Lescoeur and Rigaut<sup>3</sup> who added a small fragment of previously fused potassium cyanide to pure, anhydrous hydrogen cyanide. "At the end of twenty hours the liquid was colored a deep brown and after six days the solidification was complete. This solidification is accompanied by a large increase in volume which usually breaks the flasks.

"The black mass thus obtained is usually amorphous but often mixed with more or less transparent crystals which can be extracted with boiling benzene or ether. One obtains brilliant, colorless crystals, which change readily, turning brown. These crystals are soluble in alcohol and boiling water, sparingly soluble in cold water, and having a very bitter taste. In a short time brown flocks separate from the aqueous solution. Platinic chloride gives a beautiful green color.

"The composition of the material is that of hydrocyanic acid, HCN. The substance dissolves readily in acids and appears to be a weak base. The compound with hydrochloric acid is a hygroscopic mass, probably having the composition  $(\text{HCN})_3.3\text{HCl}.3\text{H}_2\text{O}$ . It can be dried on the stove, losing hydrogen chloride slowly and tending towards the composition  $(\text{HCN})_3.\text{HCl}$ ."

This cannot be the same as the compound  $\text{HCN.HCl}$  obtained by Gautier, because the latter dissociates into hydrogen chloride and hydrogen cyanide, leaving no solid behind.

A polymer of imino-formyl chloride would have three hydrogen chlorides in a trimolecular form, and with none of them attached to nitrogen. A compound of this type could contain three hydrogen chlorides which would apparently be impossible in a six-membered ring if the hydrogen chlorides were attached to nitrogen. Since we do not yet know whether or under what circumstances this happens, this case is not covered by the present generalizations, unless formally by No. VIII.

Sidgwick<sup>4</sup> says: "It is remarkable that while the alkyl cyanides give the pyrimidine derivatives, the triple polymer (cyaphenine) which benzonitrile

<sup>1</sup> Gautier: *Ann.*, 149, 29; 151, 239 (1869).

<sup>2</sup> "A Treatise on Chemistry," 3 I, 524 (1886).

<sup>3</sup> *Compt. rend.*, 89, 310 (1899).

<sup>4</sup> "The Organic Chemistry of Nitrogen," 205 (1910).

forms under the same conditions has quite a different constitution, being a cyanuric compound with the tricyanogen ring:—

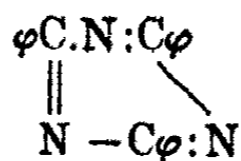

while benzoyl cyanide forms a triple polymer of a different type again, whose formula<sup>1</sup> is probably:— $\varphi\text{CO}:\text{N}:\text{C}:\text{C}:\text{N}:\text{C}(\text{C})\varphi$ , as well as a double polymer<sup>2</sup>

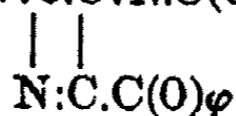

which seems to have the structure

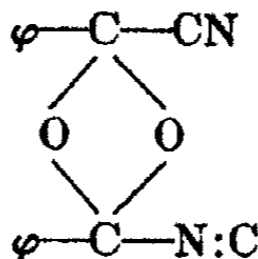

In a later paragraph Sidgwick<sup>3</sup> gives an explanation for the difference in behavior of acetonitrile and benzonitrile. "Nearly all cyanogen compounds polymerize with great ease to form trimolecular polymers, which in most cases can readily be reconverted into the simple bodies. The most natural way of accounting for this is to suppose that the three CN groups combine to form a tricyanogen ring of the form  $\text{N}-\text{C}-\text{N}$ . A strict proof of the existence

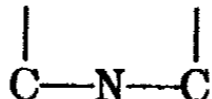

of this ring is still wanting; but it has been shown that the tricyanogen complex has a symmetrical structure. If cyanuric chloride is treated with ammonia or amines, the chlorine atoms are replaced by  $\text{NH}_2$  or substituted  $\text{NH}_2$  groups. By regulating the quantities, the replacement may be made to occur in three stages, and by using successively ammonia, methylamine, and ethylamine, we can replace the three chlorine atoms by amino-, methylamino-, and ethylamino-groups respectively, giving a substance known as methyl-ethyl-melamine,  $(\text{C}_3\text{N}_3)(\text{NH}_2)(\text{NHCH}_3)(\text{NHC}_2\text{H}_5)$ . Now it is found that whatever be the order in which the three groups are introduced, the same product is obtained, proving that the central  $\text{C}_3\text{N}_3$  nucleus is symmetrical, and this can only be accounted for by assuming the existence of a ring of the form suggested above which is known as the triazine ring.

"The mother substance of the group, triazine or tricyanogen hydride, has not yet been prepared. It may have two tautomeric formulae:

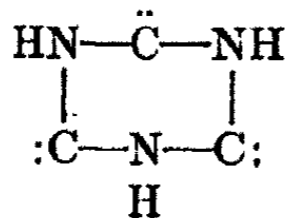

and

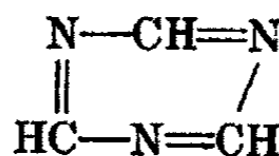

<sup>1</sup> Diehls and Stein: Ber., 40, 1665 (1907).

<sup>2</sup> Diehls and Pillow: Ber., 41, 1893 (1908).

<sup>3</sup> "The Organic Chemistry of Nitrogen," 231 (1910).

The simple derivatives—those which contain no oxygen and only have the hydrogen of the triazine group replaced by hydrocarbon groups—must all be derived from the first or second formula, since they are formed by the polymerization of nitriles and not of isocyanides. But, as has been pointed out, the usual product of the polymerization of a nitrile is a cyanalkine, an aminopyrimidine, such as

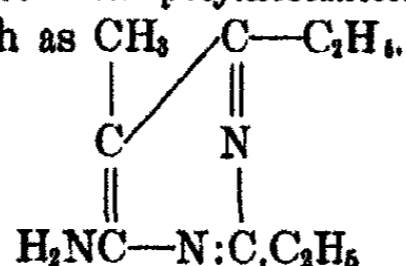

CN groups forming the ring, one nitrogen is driven outside, while a carbon atom from one of the alkyls takes its place. This is obviously only possible if the nitrile employed has, next to the CN, a carbon atom united to hydrogen. Hence, if a nitrile is used which has no hydrogen on this carbon, the reaction takes a different course and a triazine (tricyanogen) compound is formed. For instance, benzonitrile polymerizes in presence of sulphuric acid to form triphenyl-triazine: In this case a pyrimidine could not be formed without breaking one of the benzene rings."

Apparently the 2-4-6-triphenyl-1-3-5-triazene, cyaphenine, has no basic properties at all. Diphenyl triazene<sup>1</sup> is a very weak base. Krafft and von Hansen<sup>2</sup> have studied the methyl diphenyl tricyanide or triazene. "The substance has basic properties, but only to a slight extent in spite of its high nitrogen content. The hydrochloride  $\text{C}_{16}\text{H}_{13}\text{N}_3 \cdot \text{HCl}$  can be prepared with ease if one leads dry hydrogen chloride into the benzene solution of the base, whereupon it precipitates in difficultly soluble needles which decompose even when shaken with cold water. This property can be used for determining the hydrogen chloride content. If one heats the hydrochloride alone to about  $150^\circ$ , there is a vigorous revolution of hydrogen chloride and the pure base remains behind, easily recognizable by its melting-point."

According to the generalizations previously made, all three of these substances should add on two hydrogen chlorides, since one nitrogen can be ruled out because it is attached to a carbon which already has a pentavalent nitrogen. Actually cyaphenine adds no hydrogen chlorides, while methyl diphenyl triazene and diphenyl triazene add only one hydrogen chloride each.

The difference in the case of the cyanphenine is evidently due to three phenyl groups, in which case it follows that the two phenyl groups in the other two cases account for the other two compounds not taking their quota.

This is evidently the idea held by Krafft and von Hansen. "That a platinum double salt cannot be made in spite of all efforts finds a sufficient explanation—if one considers cyaphenine as a tricyanide—in the replacement of the positive alkyl radical of the very weak base (methyldiphenyl tricyanide) by a negative phenyl group. We will express a definite opinion on this matter later. It has been known for a long time that cyaphenine has no basic properties."

<sup>1</sup> Bladin: Ber., 22, 802 (1889).

<sup>2</sup> Ber., 22, 804 (1889).

While this is undoubtedly true, the phenyl groups in these compounds are having a more negative effect than in any substance previously discussed. If we were to consider each nitrogen as a dibenzylamine nitrogen, the three compounds should each add two hydrogen chlorides instead of one in each of two cases and none in the third case. It hardly seems worth while to make a special generalization to fit this case until one knows just how it might be worded. If one had data on a compound like  $C_6H_5C:NR(NR_2)$ , it might be easier to formulate things more definitely. For the time being it is better to let cyaphenine stand as an apparent exception, for which we already know the explanation in a general way but not the best way in which to word the explanation.

If the dissociation pressure for the first nitrogen in cyaphenine and for the second nitrogen in methyl diphenyl tricyanide were high enough, the hydrogen chloride might be lost while getting the crystals out of the benzene and drying them. We do not believe, however, that the discrepancy is due to experimental error. It seems much more probable that the general theory is not yet worded in a sufficiently accurate way.

On the other hand there must be something wrong in the statement of Otto and Voight<sup>1</sup> that triethyl tricyanide reacts neutral in solution and does not form a hydrochloride, even though it is somewhat more soluble in aqueous hydrochloric acid than in water. When this compound is reduced, one nitrogen comes out as ammonia and the new base  $C_9H_{15}N_2$  is reported by Troeger<sup>2</sup> to react alkaline in solution and to act as a monacid base. The constitution of the base is  $C_2H_5.C \text{---} C.C_2H_5$ .

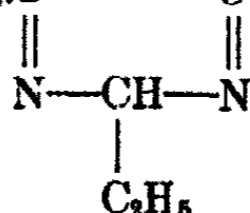

In connection with cyaphenine we should like to see experiments made on the action of hydrogen chloride on the polymerized chloral-imide<sup>3</sup>:—

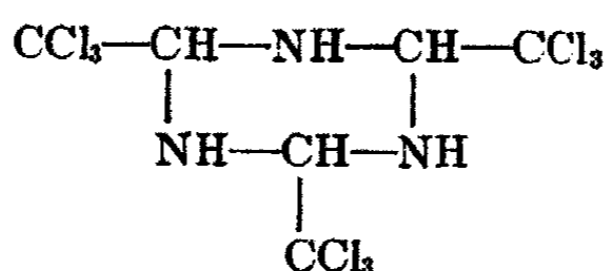

As oxidation products of prussic acid, or isomers thereof, we have cyanic acid,  $HOC:N$ , isocyanic acid,  $HN:CO$ , and fulminic acid,  $C:NOH$ . Sidgwick<sup>4</sup> says that isocyanates combine directly with hydrochloric acid to form substituted carbamic chlorides:—

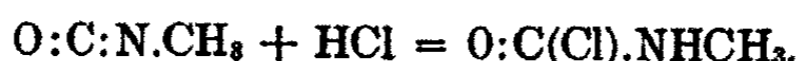

<sup>1</sup> J. prakt. Chem., (2) 36, 78 (1887).

<sup>2</sup> J. prakt. Chem., (2) 50, 458 (1894).

<sup>3</sup> Meyer and Jacobson: "Lehrbuch der organischen Chemie," 1 II, 873 (1913).

<sup>4</sup> "The Theory of Organic Chemistry," 219 (1910).

This reaction is to be contrasted with that of an isocyanide with hydrochloric acid, which is due to the dyad carbon:  $R.N:C + HCl = R.N:C(H)Cl$ ."

In regard to the cyanates Sidgwick<sup>1</sup> says: "Among the cyanic acid derivatives the formation of tricyanogen compounds is quite general. Cyanuric acid,  $C_3N_3O_3H_3$ , the mother substance of this group, is formed by the spontaneous polymerization of cyanic acid and also by heating urea and many of its derivatives. It can obviously occur in two tautomeric forms, one derived from normal cyanic acid  $HO.CN$ , and the other from isocyanic acid  $HN:C:O$  :—

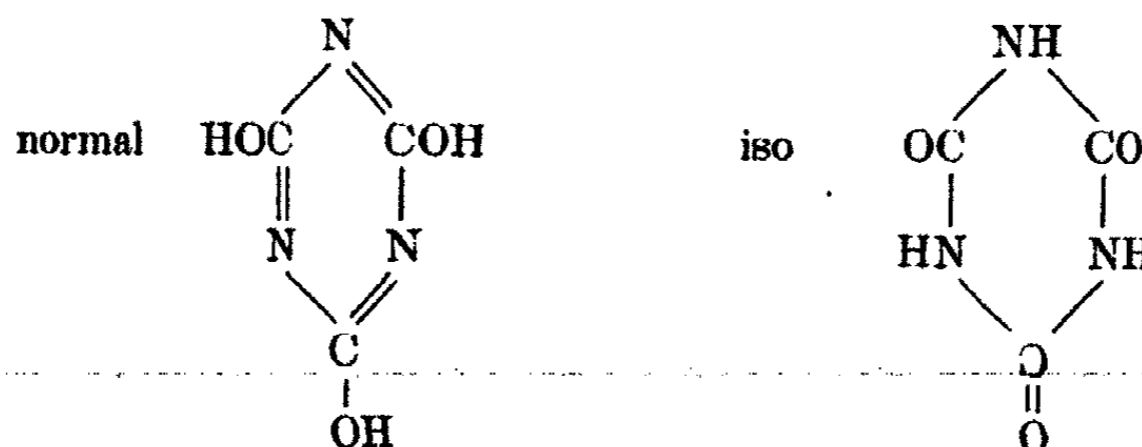

The balance of evidence is on the whole in favour of the iso (imide) structure for the free acid. The tri-N-ester, the derivative of this form, is the product of the action of diazomethane on the acid.<sup>2</sup> Cyanuric acid is a pseudo-acid, and the sodium salt, which is derived from the true acid form, shows by its behaviour that it has the metal attached to the oxygen: from which it follows that the free acid must be the imide. The same conclusion has been arrived at by Hartley from the absorption spectra of cyanuric acid and its derivatives. . . .

"The esters of cyanuric acid exist in four isomeric forms, as each alkyl group may be attached either to oxygen or to nitrogen,  $Alk.O.C:N$ . or  $Alk.N.C:O$ . The tri-O-ester and the tri-N-ester have long been known; and Hantzsch<sup>3</sup> has recently prepared the two mixed compounds. The tri-O-ester is obtained from cyanuric bromide and sodium methylate; the di-O-mono-N-ester from silver cyanurate and methyl iodide below  $0^\circ$ ; the mono-O-di-N-ester from silver cyanate and methyl iodide at low temperatures: while these bodies if warm give the tri-N-compound."

Cyamelide must be a polymer of  $HN:C:O$  with the structure:—

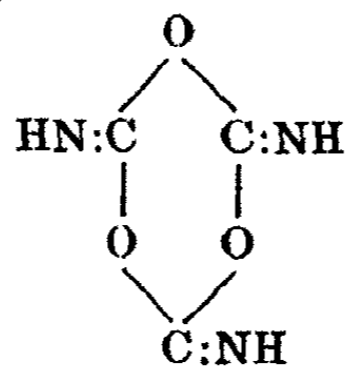

Sidgwick<sup>4</sup> also has a few paragraphs on fulminic acid and the fulminates.

<sup>1</sup> "The Organic Chemistry of Nitrogen," 233, 235 (1910).

<sup>2</sup> Palazzo and Scelsi: Gazz., 33 I, 659 (1908).

<sup>3</sup> Hantzsch and Bauer: Ber., 38, 1005 (1905).

<sup>4</sup> "The Organic Chemistry of Nitrogen," 224, 228 (1910).

"If sodium fulminate is treated with hydrochloric acid at 0° the fulminic acid first liberated forms an addition compound with the hydrochloric acid, the carbon becoming tetravalent:—  $\text{HO.N:C} + \text{HCl} = \text{HON:C(Cl)H}$ . This body is the oxime of formyl chloride,  $\text{O:C(Cl)H}$ , and is therefore called formyl chloride oxime. . . . If the ethereal solution of free fulminic acid, obtained by extracting the acidified solution of the potassium salt with ether, is allowed to stand, a triple polymer, originally known as isocyanuric acid, but now more conveniently termed metafulminuric acid, is produced. This has been shown to be

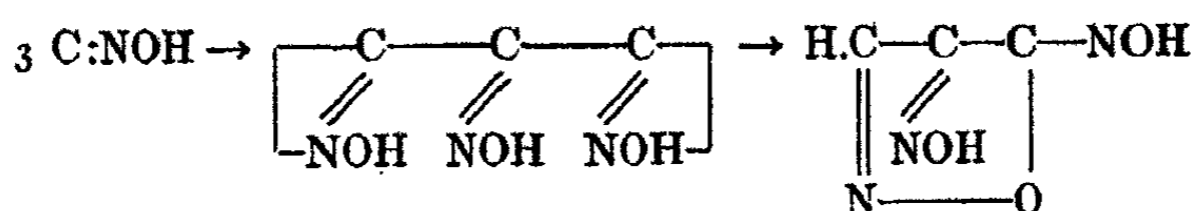

isonitroso-isoxazolone<sup>1</sup>:—

"This polymerization brings out the resemblance of fulminic and hydrocyanic acid as compounds of dyad carbon. It is exactly analogous to the polymerization of hydrocyanic acid in presence of alkali to amino-malonitrile:—

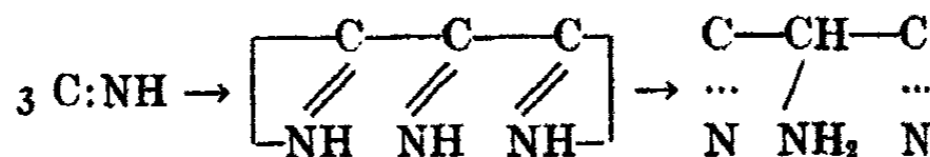

"The corresponding compounds of tetrad carbon, the nitriles, cyanates, isocyanates, and the nitrile-oxides, all polymerize to form a symmetrical 6-ring, as in cyamelide and cyanuric acid."

As typical cases to be considered, we may take isocyanuric acid, cyamelide, and melamine.

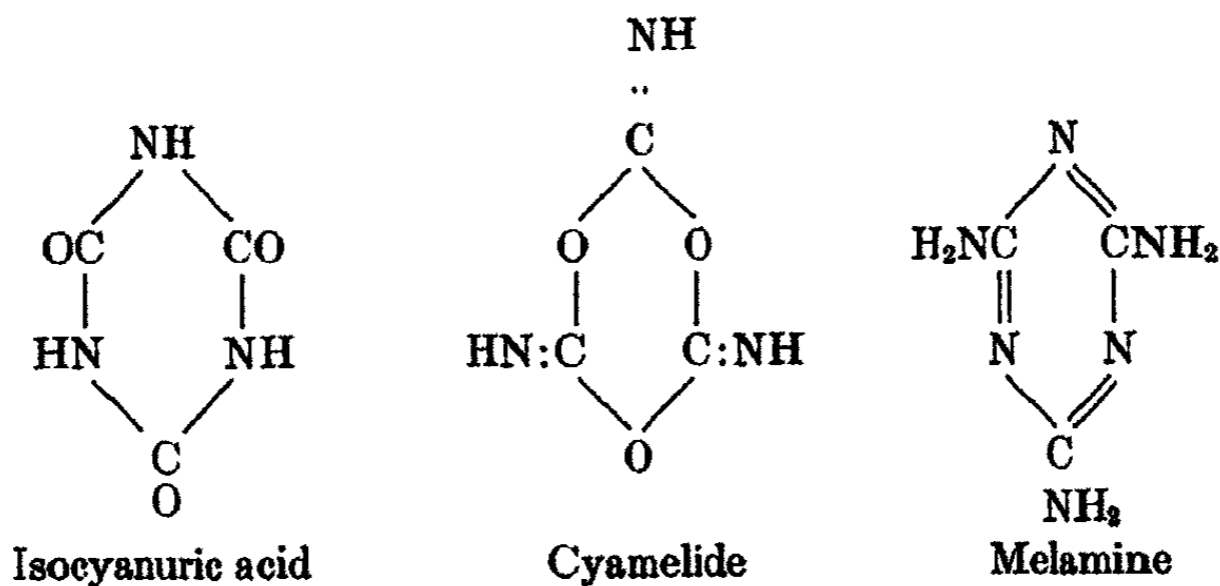

In isocyanuric acid we have three diketo linkages and consequently none of the nitrogens should add on hydrogen chloride. Experimentally, this seems to be true. In cyamelide we have three ether oxygens and we have no data to show how much of a negative effect these will produce. Some imido

<sup>1</sup> Wieland and Hess: Ber., 42, 1346(1909).



ethers are known;<sup>1</sup> but there are not enough data to enable us to draw any conclusions in regard to cyamelide, even if the matter were not complicated by the fact that there are two ether oxygens attached to each carbon. Meyer and Jacobson<sup>2</sup> say that melamine is a strong monacid base. It does not seem possible that this can be true. Symmetrical triamido benzene adds on three hydrogen chlorides and the substitution of three nitrogens for three carbons ought not to affect this. It is therefore probable that the data in the literature are wrong.

It is a pleasure to turn from these doubtful cases to a few which belong together irrespective of the number of nitrogens, and which behave just as they should. In the ethylene amines<sup>3</sup> the basicity is equal to the number of the nitrogens. The diamines add two molecules of hydrogen chloride, the triamines three, and the tetramines four. This includes ethylene diamine, diethylene diamine, triethylene diamine, tetraethylene diamine, diethyl ethylene diamine, tetraethyl ethylene diamine, hexaethyl ethylene diamine, diethylene triamine, triethylene triamine, etc.

With hexamethylene tetramine one would expect fewer than four hydrochlorides to be taken up, because there are three nitrogens attached to each carbon, just as there is in guanidine where only one hydrogen chloride is taken up. The difference is that in hexamethylene tetramine each nitrogen is attached to three alkyl carbons and this counterbalances the other effect.

In the next paper of this series we shall take up the behavior of the poly-nitrogen compounds. The general results of this paper are as follows:—

1. All trivalent nitrogens tend to add on hydrogen chloride and go over to what most people call pentavalent nitrogen. Adoption of Werner's method of writing formulas does not change any of the conclusions. The nitrogen will become pentavalent in presence of hydrogen chloride unless prevented by the presence of a sufficient number of negative radicals or by some special linkage such as may occur in the cyanides, cyanates, etc.

2. Alkyl groups are positive and aryl groups are negative. Other negative groups are the halogens, oxygen, etc.

3. All the alkyl amines add hydrogen chloride and the ethylene polyamines add as many hydrogen chlorides as there are nitrogens in the molecule. Triphenylamine does not add hydrogen chloride, but tribenzylamine does.

4. Pyridine, pyrrol, quinoline, naphthylamine, and anthramine add hydrogen chloride. The hydrogenated substances are more alkaline than the parent compounds.

5. All the alkaloids with one nitrogen add one hydrogen chloride.

6. The ordinary tribromaniline only adds hydrogen chloride from a fairly concentrated hydrochloric acid solution. The other tribromanilines add hydrogen chloride more readily.

<sup>1</sup> "Lehrbuch der organischen Chemie," 1, 374 (1893).

<sup>2</sup> "Lehrbuch der organischen Chemie," 1, 1033 (1893).

<sup>3</sup> Laubenheimer: "Die grundzüge der organischen Chemie," 298 (1884).

7. The acid amides add hydrogen chloride; but the diacetamides do not.
8. Succinimide and phthalimide do not add hydrogen chloride on account of the diketo linkage.
9. All the amino acids add hydrogen chloride except those like taurine and hippuric acid, where the nitrogen is already pentavalent owing to the formation of an intramolecular salt which is not decomposed by hydrogen chloride. The ethyl ester of hippuric acid does add hydrogen chloride.
10. Nitro groups are more effective than the halogens in decreasing alkalinity. The hydroxylamines add hydrogen chloride.
11. The various cyanides and cyanates do not add hydrogen chloride direct to nitrogen, but add it in other ways so that the nitrogen remains trivalent.
12. Carbylamine adds hydrogen chloride, the compound containing two molecules of carbylamine and three of hydrogen chloride. The first reaction appears to be  $2\text{CH}_3\text{NC} + 2\text{HCl} = 2\text{CH}_3\text{NCHCl}$ . How the third hydrogen chloride adds on seems not to be decided.
13. Prussic acid adds hydrogen chloride reversibly to form imino-formyl chloride,  $\text{H}_2\text{C}(\text{Cl})\text{:NH}$ . With a higher concentration of hydrogen chloride or, more easily, with hydrogen bromide, a compound is formed, having the empirical composition  $(\text{HCN})_{3.3}\text{HX}$ . There is no agreement as to the way in which the third halogen acid adds on.
14. If imino-formyl chloride were to polymerize, it might give a compound with the hydrogen chlorides attached to carbon and not to hydrogen. Lescoeur and Rigaut have prepared a compound to which they assign the formula  $(\text{HCN})_{3.3}\text{HCl}_{.3}\text{H}_2\text{O}$ . Since there is no apparent way in which three hydrogen chlorides can be attached to three nitrogens if this is a six-membered ring, there is the possibility that some or all of the hydrogen chlorides are attached to carbon.

*Cornell University.*

## PLATINUM BLACK CATALYSTS

### II. Heats of Adsorption\*

BY GUY B. TAYLOR, GEORGE B. KISTIAKOWSKY, AND JOHN H. PERRY

#### Introduction

Studies of gaseous adsorption on solid surfaces have yielded many important facts in connection with the general study of heterogeneous catalysis. The determinations of adsorption isotherms at one temperature only yield, however, a somewhat incomplete picture, leading to uncertain conclusions as to the forces at play. In the case of finely divided metals the application of the Clausius-Clapeyron equation meets serious obstacles in the non-reversible and non-reproducible character of adsorption, owing mainly to the rapid deterioration of such preparations under the influence of higher temperatures. In cases like these the application of direct calorimetric methods for the determination of the heats of adsorption appears desirable. Heats of adsorption of various gases have been measured directly by a number of independent investigators,<sup>1</sup> data being obtained which confirm generally the results of the isotherm studies and reveal some new features. For a detailed investigation of the forces exhibited by the surfaces, the study of the differential heats of adsorption has been found to be particularly advantageous. Their variation with the degree of saturation of the surface offers means of investigating the non-uniformity of the structure of the surfaces.

#### Apparatus

In an earlier paper<sup>2</sup> there has been described an all-glass calorimeter adapted to the study of the differential heats of adsorption. Although that apparatus gave satisfactory service, its handling was rather cumbersome. Therefore, Mr. E. W. Flosdorf, who continued the study of the heats of adsorption at Princeton, has modified this calorimeter, substituting a multiple thermocouple for the platinum resistance thermometer and making changes in the design of the glass parts. Greater ease of operation and slightly higher sensitivity were achieved. This new form of calorimeter was used in the present research. Its description will be published by Mr. Flosdorf. One further change in the apparatus was made during the present experiments. The electric calibration heater which was wound in the older model on the outside wall of the adsorbent chamber was now placed inside, being embedded in the mass of the adsorbent material. The dead space of the calorimeter

\* Contribution No. 23 from the Experimental Station of E. I. du Pont de Nemours and Company.

<sup>1</sup> More recently by Foresti: *Gazz.*, **53**, 487 (1923); Beebe and Taylor: *J. Am. Chem. Soc.*, **46**, 43 (1924); Fryling: *J. Phys. Chem.*, **30**, 818 (1926); Magnus: *Z. anorg. Chem.*, **164**, 345 (1927); Kistiakowsky: *Proc. Nat. Acad. Sci.*, **13**, 1 (1927); Garner and McKie: *J. Chem. Soc.*, 1927, 2451; Kistiakowsky, Flosdorf and Taylor: *J. Am. Chem. Soc.*, **49**, 2200 (1927).

<sup>2</sup> H. S. Taylor and G. B. Kistiakowsky: *Z. physik. Chem.*, **125**, 341 (1927).

was reduced to 63-68 cc. to obtain greater accuracy in measurements with weakly adsorbed gases. Since the earlier experiments had indicated that in high vacuum a mass of finely divided metal is a very poor heat conductor, a small quantity of argon—0.04 to 0.3 mm. pressure—was put in the calorimeter during the present measurements. It was found by special tests that such a pressure of argon was quite sufficient to insure rapid heat exchange. In all other details the apparatus was essentially identical with the one used previously.

Of the gases used for the adsorption measurements, hydrogen was generated electrolytically, passed over a heated platinum coil, and dried over phosphorus pentoxide. Oxygen and sulfur dioxide were taken from tanks. Both were dried over phosphorus pentoxide. Carbon monoxide was prepared from formic acid, freed from carbon dioxide, and dried.

The preparation of the three samples of platinum black has been described in Part I.

#### Experimental Results

In the following tables are presented some of the results obtained. The heading of each table gives the number of the black, the gas being adsorbed, and the treatment to which the black was subjected prior to the experiment. Since the tables are arranged in chronological order and all experiments of these series are given, the sum of all previous heating periods represents the total time of heating of a black previous to the experiment considered. The first column in the tables gives the successive amounts of gas admitted into the calorimeter, expressed in cc. at N.T.P. The second column gives the increase in pressure in mm. of mercury after each admission; in the third column are represented the amounts of gas adsorbed, calculated from the

#### EXPT. NO. 1 Platinum Black No. 1 H<sub>2</sub> Adsorption

Treated with H<sub>2</sub> at 250° and degassed at 350° for seven hours

Amount admitted in cc. at N.T.P.	Pressure increase in mm. Hg.	Amount adsorbed	Heat of adsorption in cal/mol.	Total amount adsorbed in cc. at N.T.P.	Total pressure in mm. Hg.
0.199	0.68	0.143	?	0.324	0.68
.199	1.32	0.081	18,900	.567	1.80
.199	1.45	0.080	12,100	.775	3.10
.199	1.40	0.084	10,500	.985	4.41
.199	1.60	0.068	11,300	1.16	5.66
3.59	35.1	0.72	8,300	2.87	40.5
3.44	38.3	0.31	10,900	3.73	77.8
3.22	37.6	0.14	10,400	4.11	115.0
3.05	35.5	0.10?	12,800?	4.38	151.0
2.93	34.7	0.09?	14,100?	(4.94	185.0 (10 min.)
				(6.41	177.0 (18 hr.)

EXPT. No. 2  
Platinum Black No. 1  
H<sub>2</sub> Adsorption

Degassed at 350° for eight hours.

Amount admitted in cc. at N.T.P.	Pressure increase in mm. Hg.	Amount adsorbed	Heat of adsorption in cal/mol.	Total amount adsorbed in cc. at N.T.P.	Total pressure in mm. Hg.
0.190	1.15	0.096	6,800	0.240	1.03
.190	1.25	0.088	5,900	0.452	2.20
.190	1.50	0.067	6,800	0.645	3.60
.190	1.60	0.059	5,800	0.790	5.00
3.57	39.60	0.33	3,600	1.61	43.20
3.43	39.50	0.20	2,700	2.24	82.70
3.22	38.0	0.11	5,400?	2.55	120.70

EXPT. No. 3  
Platinum Black No. 1  
O<sub>2</sub> Adsorption

Degassed at 350° for one and one-half hours. Air then leaked into the apparatus. The sample treated at 350° with H<sub>2</sub> and degassed at 350° for four hours.

0.196	0.025	0.194	51,500	0.438	0.025
0.196	0.030	0.194	43,200	0.877	0.053
0.196	0.025	0.194	39,000	1.31	0.080
0.196	0.035	0.193	44,800	1.75	0.115
0.196	0.030	0.194	43,000	2.19	0.140
0.196	0.040	0.192	44,800	2.62	0.170
0.196	0.030	0.193	43,600	3.06	0.20
0.196	0.130	0.185	45,700	3.50	0.22
0.196	0.54	0.153	45,100	3.92	0.35
0.196	0.40	0.163	31,400	4.34	0.43
0.196	1.67	0.063	28,300	4.82	0.30
3.58	40.5	0.26	13,300	5.47	40.5 (2 hr.)
3.40	40.1	0.12	7,500	5.76	80.5

EXPT. No. 4  
Platinum Black No. 1  
O<sub>2</sub> Adsorption

Degassed at 350° for five hours.

0.199	2.20	0.019?	?	0.061	2.07
3.59	41.40	.20	3,500	.54	43.4

EXPT. No. 5  
Platinum Black No. 1  
H<sub>2</sub> Adsorption on O<sub>2</sub>-covered Platinum  
O<sub>2</sub> pumped off at 0° for one hour.

Amount admitted in cc. at N.T.P.	Pressure increase in mm. Hg.	Amount adsorbed	Heat of adsorption in cal/mol.	Total amount adsorbed in cc. at N.T.P.	Total pressure in mm. Hg.
0.198	0.020	0.196	30,600	0.443	0.02
0.198	0.025	0.196	32,500	0.864	0.04
0.198	0.025	0.196	33,700	1.31	0.06
0.198	0.040	0.195	31,900	1.75	0.08
0.198	0.040	0.195	31,900	2.19	0.10
0.198	0.040	0.195	30,700	2.62	0.12
0.198	0.040	0.195	30,700	3.07	0.15
0.198	0.040	0.195	32,200	3.51	0.18
0.198	0.050	0.194	32,200	3.95	0.21
0.388	0.060	0.383	31,100	4.82	0.27
0.388	0.040	0.383	33,800	5.69	0.30
0.388	0.050	0.384	32,600	6.55	0.35
0.388	0.080	0.382	34,900	7.42	0.42
0.388	0.10	0.380	34,600	8.28	0.50
0.388	0.40	0.355	31,000	9.08	0.89
3.52	39.3	0.30	12,300	9.83	39.9

EXPT. No. 6  
Platinum Black No. 1  
H<sub>2</sub> Adsorption  
Degassed at 350° for five hours.

0.189	1.73	0.046	10,700?	0.122	1.60
3.57	41.9	0.14	12,200?	.452	43.50

EXPT. No. 7  
Platinum Black No. 1  
O<sub>2</sub> Adsorption  
Degassed at 350° for four hours.

Amount admitted in cc. at N.T.P.	Pressure increase in mm. Hg.	Amount adsorbed	Heat of adsorption in cal/mol.	Total amount adsorbed in cc. at N.T.P.	Total pressure in mm. Hg.
0.196	0.58	0.140	34,800	0.407	0.20
.196	1.50	.073	29,400	0.650	1.28
3.55	40.6	.23	23,300	1.76	37.4 (1.5 hr.)

pressure-increase readings and from measurements of the dead space. The fourth column gives the differential heats of adsorption in calories per mole. The last two columns give the total adsorption in cc. per 100 g. of the adsorbent and the (near-) equilibrium gas pressure, respectively. The data of columns 5 and 6 do not follow directly from those of columns 2 and 3. The data of columns 2 and 3 were used for the calculation of the heats of adsorption. They were obtained, usually, by means of graphical interpolation, for the same time (2 to 4 minutes) after the gas admission as the time of maximum temperature change. Columns 5 and 6, on the other hand, present the readings taken ten minutes after the gas admission. A comparison between these two sets of data is useful in showing to what extent a drift in adsorption took place. Some of the data of the last two columns were obtained much later than ten minutes after the gas admission, and this is noted

## EXPT. No. 8

## Platinum Black No. 1

SO<sub>2</sub> Adsorption

Heated in H<sub>2</sub> to 350°, degassed at 350° for six hours.

Amount admitted in cc. at N.T.P.	Pressure increase in mm. Hg.	Amount adsorbed	Heat of adsorption in cal/mol.	Total amount adsorbed in cc. at N.T.P.	Total pressure in mm. Hg.
0.199	0.30	0.175	37,200	0.414	0.20
0.199	0.90	.125	31,400	0.751	0.80
0.199	1.30	.092	38,600	1.02	1.82
0.199	1.30	.092	24,800	1.32	2.59
0.199	1.30	.092	18,400	(1.61	3.44
				(1.72	2.87 (0.5 hr.)

These results are very uncertain owing to difficulties with the buret readings.

## EXPT. No. 9

## Platinum Black No. 2

H<sub>2</sub> Adsorption

Treated with H<sub>2</sub> at room temperature; degassed at 250° for five hours.

0.177	0.005	0.177	?	0.697	0.005
0.177	0.01	0.176	32,400	1.39	0.015
0.177	0.00	0.177	28,900	2.09	0.015
0.177	0.00	0.177	27,600	2.79	0.015
0.177	0.01	0.175	24,900	3.48	0.025
3.38	6.00	2.84	15,300	15.4	4.2
3.42				19.2	31.3
3.22				22.1	60.8
3.13				23.6	91.3
2.91				25.2	119.3
2.95				26.3	148.8

in the tables. In the case of oxygen adsorptions the gas pressures recorded do not represent the true pressures of oxygen over the adsorbent since the tank gas contained at least 0.5 per cent nitrogen which, as it is less strongly adsorbed, remained mostly in the gas phase and was included in the pressure measurements. All the measurements were made at substantially 0°C. The weights of platinum used in the calorimeter were as follows, No. 1—44.2 g., No. 2—25.4 g., No. 3—19.0 g.

EXPT. No. 10  
Platinum Black No. 2  
O<sub>2</sub> Adsorption

Degassed at 250° for five hours.

Amount admitted in cc. at N.T.P.	Pressure increase in mm. Hg.	Amount adsorbed	Heat of adsorption in cal/mol.	Total amount adsorbed in cc. at N.T.P.	Total pressure in mm. Hg.
0.182	0.15	0.169	161,000	0.705	0.03
0.182	0.18	0.166	142,000	1.42	0.04
0.182	0.14	0.169	126,000	2.13	0.05
0.182	0.22	0.162	122,000	2.83	0.05
0.182	0.15	0.169	112,000	3.56	0.06
2.89	0.46	2.85	104,000	14.9	0.22
2.89				26.2	0.45
2.89				37.5	0.61
2.89				47.8	3.02
2.87				55.4	13.6
2.86				57.0	39.6
2.80				58.1	66.6

EXPT. No. 11  
Platinum Black No. 2

H<sub>2</sub> Adsorption on O<sub>2</sub>-covered Platinum

0.183	0.00	0.183	97,000	0.722	0.00
0.183	0.00	0.183	94,000	1.44	0.00
0.183	0.00	0.183	93,200	2.16	0.00
0.183	0.00	0.183	86,500	2.88	0.00
3.75	0.10	3.74	78,000	17.7	0.09
3.56				31.6	0.26
3.67				46.0	0.48
7.26				73.5	0.93
10.95				117.	3.62
3.56				129	ca .9



EXPT. NO. 12  
Platinum Black No. 2  
H<sub>2</sub> Adsorption

Treated with H<sub>2</sub> at 250°, and degassed at 250° for four hours.

Amount admitted in cc. at N.T.P.	Pressure increase in mm. Hg.	Amount adsorbed	Heat of adsorption in cal/mol.	Total amount adsorbed in cc. at N.T.P.	Total pressure in mm. Hg.
0.205	0.005	0.205	29,700	0.808	0.005
0.205	0.005	0.205	25,600	1.62	0.010
0.205	0.005	0.205	22,100	2.42	0.010
0.205	0.005	0.205	22,100	3.23	0.101
0.205	0.010	0.205	19,500	4.02	0.020
0.399	0.02	0.396	21,600	5.60	0.030
0.398	0.06	0.393	18,500	7.15	0.060
0.398	0.14	0.385	17,200	8.70	0.15
0.398	0.31	0.370	17,500	10.2	0.35
0.398	0.65	0.339	15,900	11.6	0.80
3.54	25.8	1.22	12,800	17.3	24.0
3.43	32.7	0.48	9,200	20.0	54.0
3.29	32.7	0.34	8,000	21.8	85.9
3.13	32.7	0.18	9,500	23.1	117.1

EXPT. NO. 13  
Platinum Black No. 2

O<sub>2</sub> Adsorption on H<sub>2</sub>-covered Platinum

H<sub>2</sub> pumped off at 0° for one and one-half hours.

0.203	0.02	0.201	220,000
0.203	0.07	0.197	214,000

EXPT. NO. 14  
Platinum Black No. 2

H<sub>2</sub> Adsorption

Degassed at 350° for five hours.

Amount admitted in cc. at N.T.P.	Pressure increase in mm. Hg.	Amount adsorbed	Heat of adsorption in cal/mol.	Total amount adsorbed in cc. at N.T.P.	Total pressure in mm. Hg.
0.195	0.03	0.192	22,600	0.710	0.02
0.195	0.08	0.187	19,200	1.52	0.06
0.390	1.05	0.295	14,100	2.89	0.52
0.390	1.95	0.214	10,600	3.91	2.00
0.390	2.34	0.179	11,600	(4.70)	4.10
				(5.31)	2.38 45 (min.)
0.349	34.1	0.42	11,500	7.56	34.8
3.38	34.9	0.23	10,600	8.90	68.6
3.22	33.7	0.18	12,200?	9.97	101.3

EXPT. NO. 15  
Platinum Black No. 2  
H<sub>2</sub> Adsorption

Degassed at 350° for twenty hours.

Amount admitted in cc. at N.T.P.	Pressure increase in mm. Hg.	Amount adsorbed	Heat of adsorption in cal/mol.	Total amount adsorbed in cc. at N.T.P.	Total pressure in mm. Hg.
0.190	0.04	0.187	17,600	0.737	0.025
0.390	1.28	.275	9,300	1.99	0.81
3.45	32.6	.51	10,900	4.61	31.7
3.38	35.5	.18	12,900	8.80	57.4 (2 hr.)
3.27	25.6	.06?	26,500?	9.06	93.0

Electric measurements were not very satisfactory. Heats of adsorption may be considerably in error, particularly the first two values.

EXPT. NO. 16  
Platinum Black No. 2  
CO Adsorption

Degassed at 350° for four hours.

0.206	0.005	0.206	34,600	0.812	0.005
0.206	0.005	0.206	?	1.62	0.01
0.206	0.010	0.205	28,000	2.44	0.01
0.394	0.06	0.389	32,000	3.98	0.02
0.394	0.07	0.388	29,000	5.54	0.03
0.394	0.07	0.388	24,200	7.08	0.05
0.394	0.09	0.386	24,000	8.65	0.08
3.46	5.31	2.98	21,000	21.7	1.46
3.49	30.5	0.74	18,400	27.0	25.5
3.31	34.5	0.20	11,100	29.2	56.0
3.22	34.5	0.11?	12,200?	30.6	89.0

EXPT. NO. 17  
Platinum Black No. 2  
CO Adsorption

Degassed at 350° for four hours.

0.197	0.37	0.164	22,800	0.725	0.15
0.407	2.00	0.227	9,700	2.25	2.47
0.407	3.32	0.108	9,000	2.92	5.09
3.40	35.8	0.18?	23,000?	4.22	39.2

## EXPT. No. 18

## Platinum Black No. 2

O<sub>2</sub> Adsorption on CO-covered Platinum

CO pumped off at 0° for one-half hour.

0.213	2.18	0.016	77,500	0.053	2.21
0.213	1.92	0.040	70,500	0.189	4.20
0.213	1.79	0.052	72,300	0.402	5.99
3.53	20.0	1.73	74,800	7.30	25.80

N. B. The heats of adsorption in this experiment have been calculated upon the assumption that 100% of the oxygen admitted was adsorbed and that the increasing pressure was due to carbon dioxide which was given off by the surface. Note that the drift in adsorption had a negative sign in this experiment; i.e., pressure rose with time, as a comparison of columns 2 and 6 shows. This is another indication that a gas was given off by the platinum.

## EXPT. No. 19

## Platinum Black No. 2

O<sub>2</sub> Adsorption

O<sub>2</sub> admitted to the sample and the latter heated to 350°; O<sub>2</sub> pumped off for one-half hour, and the black cooled down to room temperature. H<sub>2</sub> added, and temperature raised to 350°; degassed at 350° for four hours.

Amount admitted in cc. at N.T.P.	Pressure increase in mm. Hg.	Amount adsorbed	Heat of adsorption in cal/mol.	Total amount adsorbed in cc. at N.T.P.	Total pressure in mm. Hg.
0.208	0.01	0.207	78,000	0.815	0.01
0.208	0.01	0.207	65,500	1.63	0.02
0.208	0.01	0.207	64,800	2.45	0.03
0.208	0.02	0.206	62,200	3.26	0.05
0.412	0.03	0.410	61,200	4.87	0.07
0.412	0.03	0.410	66,700	6.50	0.10
0.412	0.03	0.410	54,000	8.11	0.11
0.412	0.04	0.409	49,000	9.74	0.14
0.412	0.04	0.409	52,500	11.4	0.17
0.412	0.06	0.407	48,600	13.0	0.20
3.54	0.40	3.50	50,200	26.8	0.45
3.66	2.72	3.41	40,700	41.1	0.93
3.58	34.2	0.49	39,200	49.5	16.2 (2.5 hr.)
3.56	39.0	0.04?	55,000?	49.8	55.0

EXPT. NO. 20  
Platinum Black No. 2  
H<sub>2</sub> Adsorption on O<sub>2</sub>-covered Platinum  
O<sub>2</sub> pumped off at 0° for one hour.

Amount admitted in cc. at N.T.P.	Pressure increase in mm. Hg.	Amount adsorbed	Heat of adsorption in cal/mol.	Total amount adsorbed in cc. at N.T.P.	Total pressure in mm. Hg.
3.62	0.035	3.62	81,000	14.3	0.035
3.62	0.30	3.62	71,500	28.5	0.054
3.67				42.9	0.35 (3 min.)
3.70				57.5	0.30
3.65				72.0	0.08
7.33				99.0	5.27
3.58				105.7	26.2
6.62				108.0	93.2

EXPT. NO. 21  
Platinum Black No. 2  
H<sub>2</sub> Adsorption  
Heated in H<sub>2</sub> to 350° and degassed at 350° for four hours.

Amount admitted in cc. at N.T.P.	Pressure increase in mm. Hg.	Amount adsorbed	Heat of adsorption in cal/mol.	Total amount adsorbed in cc. at N.T.P.	Total pressure in mm. Hg.
0.192	0.00	0.192	21,600	0.756	0.00
0.192	0.04	0.188	14,300	1.50	0.04
0.407	0.73	0.341	12,400	2.90	0.60
0.407	2.18	0.211	11,200	3.85	2.46
3.51	35.0	0.35	10,000	5.60	36.5
9.94	107.7	0.27?	17,900?	7.06	142.2

EXPT. NO. 22  
Platinum Black No. 2  
SO<sub>2</sub> Adsorption  
Degassed at 350° for four hours.

Amount admitted in cc. at N.T.P.	Pressure increase in mm. Hg.	Amount adsorbed	Heat of adsorption in cal/mol.	Total amount adsorbed in cc. at N.T.P.	Total pressure in mm. Hg.
0.303	0.020	0.301	35,700	1.19	0.005
0.339	0.015	0.338	34,700	2.53	0.005
0.278	0.025	0.276	31,400	3.62	0.010
0.732	0.08	0.725	25,800	6.50	0.030
0.660	0.27	0.636	19,400	9.10	0.06
0.892	0.92	0.809	16,900	12.3	0.76
0.935	1.41	0.808	14,200	15.9	1.26
0.777	1.55	0.637	12,700	18.5	2.45
1.061	2.39	0.836	11,900	(22.1)	4.08
				(22.6)	2.76 (45 min.)

EXPT. No. 23  
Platinum Black No. 2  
SO<sub>2</sub> Adsorption

Degassed at 350° for four hours.

0.330	0.06	0.325	22,900	1.30	0.01
0.580	0.33	0.550	21,300	3.54	0.15
0.668	1.12	0.566	16,800	5.93	0.81
0.964	2.11	0.774	15,200	9.25	2.18
1.357	3.24	0.067	13,600	14.2	3.30 (30 min.)
				14.4	2.60 (1 hr.)

EXPT. No. 24  
Platinum Black No. 2  
O<sub>2</sub> Adsorption on SO<sub>2</sub>-covered Platinum

SO<sub>2</sub> pumped off at 0° for one-half hour.

Amount admitted in cc. at N.T.P.	Pressure increase in mm. Hg.	Amount adsorbed	Heat of adsorption in cal/mol.	Total amount adsorbed in cc. at N.T.P.	Total pressure in mm. Hg.
0.216	0.00	0.216	80,000	0.853	0.00
0.467	0.09	0.459	69,300	2.68	0.02
0.675	0.15	0.662	49,700	5.34	0.06
0.702	0.18	0.686	47,600	8.10	0.09
0.922	0.22	0.902	46,100	11.7	0.15
0.621	0.21	0.602	44,600	14.1	0.17
1.980	0.53	1.932	42,400	21.9	0.28
1.468	3.62	1.142	49,200	21.6	0.60
3.51	29.3	0.86?	42,300?	34.1	21.2 (15 min.)
				41.4	0.80 (19 hr.)

EXPT. No. 25  
Platinum No. 3  
H<sub>2</sub> Adsorption

Heated in H<sub>2</sub> to 250°, degassed at 250° for three hours.

0.221	0.01	0.220	28,500	1.15	0.01
0.221	.01	0.220	27,300	2.31	0.02
0.638	.01	0.637	25,000	5.66	0.03
0.620	.04	0.616	22,700	8.92	0.06
0.823	.30	0.796	18,100	13.2	0.21
0.823	1.29	0.708	15,200	17.1	1.00
1.045	4.09	0.680	12,300	21.0	4.39
1.035	7.14	0.403	9,900	23.7	10.2
3.61	33.4	0.63	9,300	27.8	41.9
3.38	35.0	0.26?	11,000?	29.7	75.7

EXPT. NO. 26  
Platinum Black No. 3  
H<sub>2</sub> Adsorption

Degassed at 250° for four hours.

Amount admitted in cc. at N.T.P.	Pressure increase in mm. Hg.	Amount adsorbed	Heat of adsorption in cal/mol.	Total amount adsorbed in cc. at N.T.P.	Total pressure in mm. Hg.
0.223	0.01	0.222	91,700	1.17	0.01
0.223	0.01	0.222	84,500	2.33	0.02
0.450	0.04	0.446	82,200	4.69	0.04
0.450	0.05	0.446	62,100	7.05	0.07
0.660	3.50	0.348	59,400	9.52	2.16
0.660	7.00	0.035?	30,000	10.0	8.50
3.63	39.5	0.10?	21,000	11.5	46.0 (1.5 hr.)

EXPT. NO. 27

Platinum Black No. 3

O<sub>2</sub> Adsorption on Platinum Partially Covered with H<sub>2</sub>

Heated in H<sub>2</sub> to 250°; degassed at 250° for five hours.

(H <sub>2</sub> ) 0.445	0.24	0.424	27,100	2.23	(H <sub>2</sub> ) 0.24
(O <sub>2</sub> ) 0.226	0.04	0.222	107,000	1.18	(O <sub>2</sub> ) 0.01
0.226	0.05	0.221	93,600	2.37	0.01
0.675	0.11	0.665	74,700	5.90	0.04
0.870	2.34	0.661	47,800	10.0	1.03
0.833	8.60	0.065?	12,100?	10.9	8.40

EXPT. NO. 28

Platinum Black No. 3

H<sub>2</sub> Adsorption on O<sub>2</sub>-covered Platinum

O<sub>2</sub> pumped off at 0° for one-half hour.

0.230	0.015	0.229	76,500	1.21	0.015
0.654	0.08	0.646	70,000	4.60	0.095
0.865	0.19	0.848	56,300	9.10	0.25
1.004	0.33	0.974	46,000	14.2	0.43
2.44	1.85	2.28	30,300	28.4	0.39
3.70	21.0	1.82	11,000	43.0	10.9 (2 hr.)

EXPT. No. 29  
Platinum Black No. 3  
H<sub>2</sub> Adsorption

Heated to 350° in H<sub>2</sub> and degassed at 350° for ten hours.

Amount admitted in cc. at N.T.P.	Pressure increase in mm. Hg.	Amount adsorbed	Heat of adsorption in cal/mol.	Total amount adsorbed in cc. at N.T.P.	Total pressure in mm. Hg.
0.380	0.005	0.380	25,600	2.00	0.005
0.977	1.39	0.860	13,800	7.06	0.22
1.040	4.67	0.645	4,100?	10.9	3.79
3.62	40.8	0.17?	17,000?	12.8	42.5
3.51	37.8	0.31?	4,200?	14.6	79.8

These results are rather uncertain owing to erroneous buret readings due to gas leakage.

EXPT. No. 30  
Platinum Black No. 3  
H<sub>2</sub> Adsorption

Degassed at 350° for sixteen hours.

0.373	0.005	0.373	28,400	1.96	0.005
0.373	0.055	0.368	20,600	3.91	0.15
0.373	0.42	0.337	13,600	5.86	0.08
0.705	3.66	0.395	8,300	8.60	2.29
7.15	79.2	0.45	9,600	13.4	76.0
9.54	106.9	0.50	5,500	19.7	174.5 (2 hr.)

EXPT. No. 31  
Platinum Black No. 3  
O<sub>2</sub> Adsorption

Air leaked into the apparatus; heated in H<sub>2</sub> at 350° and degassed at 350° for one and one-half hours.

0.371	0.01	0.370	68,700	1.34	0.01
0.724	0.05	0.720	54,700	5.74	0.06
0.715	0.71	0.655	42,300	9.48	0.12
0.932	8.8	0.188	33,500	10.6	8.4

## EXPT. NO. 32

## Platinum Black No. 3

H<sub>2</sub> Adsorption on O<sub>2</sub>-covered PlatinumO<sub>2</sub> pumped off at 0° for one-quarter hour.

Amount admitted in cc. at N.T.P.	Pressure increase in mm. Hg.	Amount adsorbed	Heat of adsorption in cal/mol.	Total amount adsorbed in cc. at N.T.P.	Total pressure in mm. Hg.
0.351	0.01	0.350	77,500	1.84	0.010
0.720	0.17	0.706	56,800	5.58	0.11
1.063	.45	1.025	47,600	11.1	0.19
1.684	2.27	1.492	45,200	20.0	0.06 (20 min.)
3.93	28.9	1.48	16,500	28.9	26.5
7.01	76.5	0.54	9,700	32.4	101.5

## EXPT. NO. 33

## Platinum Black No. 3

SO<sub>2</sub> AdsorptionHeated in H<sub>2</sub> to 350°; degassed at 250° for ten hours.

0.586	0.04	0.583	17,100	3.08	0.00
0.750	3.46	0.458	17,800	5.75	2.90
2.50	18.06	0.987	12,000	11.4	19.8

## EXPT. NO. 34

## Platinum Black No. 3

SO<sub>2</sub> Adsorption

Degassed at 250° for two and one-half hours.

1.690	10.0	0.853	10,900	4.48	10.0
-------	------	-------	--------	------	------

## EXPT. NO. 35

## Platinum Black No. 3

O<sub>2</sub> Adsorption on SO<sub>2</sub>-covered PlatinumSO<sub>2</sub> pumped off at 0° for twenty minutes.

1.060	1.50	0.933	61,500	5.16	0.94
1.025	10.2	0.161	24,400	5.80	10.7

## Discussion of Results

*Errors:*

The scattering of the single values of the heats of adsorption is not inconsiderable, about 10 or 15 per cent on the average. The accidental errors are the net result of errors committed in the measurements of (1) the gas volumes admitted, (2) the reduction factor to N.T.P., (3) the pressure increase, (4) the dead space of the calorimeter, and (5) the temperature change in the calorimeter. The errors are thus manifold, and their reduction would involve considerable further elaboration of the apparatus. The con-



sistency of the results decreases very rapidly at the end of each run when adsorption becomes weak and slow. Obviously, errors arising from the first four causes all increase in this region very rapidly. In addition, drift in adsorption frequently made it quite impossible to get an exact determination of the gas pressure and, therefore, of the amount of gas adsorbed corresponding to the observed temperature change. The general tendency of the last values in the runs to increase indicates perhaps that the dead-space values were too large throughout, or that argon, which was used as the reference gas, was adsorbed slightly on the platinum blacks.

With exception of the last quarter of each run the accidental errors should not interfere seriously with the dependability of the later conclusions since reliable graphical averages can be taken. More objectionable are some systematic errors which might have entered into the experiments. Such errors would arise mainly from the electrical temperature measurements. The temperature change accompanying an adsorption increment was taken as the distance between the extrapolated cooling curves at mid-time between the gas admission and the first reading falling on the after-cooling curve. The cooling curves, observed at one minute intervals for ten minutes before and after each admission, could be sufficiently well represented by straight lines. Tests over a wide range of cooling rates showed that the values for the heats of adsorption so obtained were independent of the rate of cooling within the limits of experimental error. They were independent also of the absolute quantity of heat evolved. This is best shown by the tables in those runs where the gas volumes consecutively adsorbed varied in the ratio 1:10 and even 1:20, the heats of adsorption still agreeing well. The electric heater used for the calibration of the calorimeter was run repeatedly with any one of the four gases studied in the calorimeter. The constancy of the heat capacity values so obtained indicated that the nature of the adsorbed gas had no influence on the readings of the calorimeter.

These considerations are intended to show that the data here presented are consistent among themselves. For the determinations of the absolute values of the heats of adsorption, electric heaters, as already mentioned, were used. Loss of energy in the leads and errors in the volt- and milliammeter readings should not influence the results by more than a few per cent. The remaining source of systematic errors which could cause the observed heats of adsorption to be excessively large is a loss of energy to the surroundings by the heater itself. Indeed, comparisons of the results obtained by means of internal and external heaters showed that in the latter case an appreciable fraction of introduced energy escaped the calorimeter vessel. Most likely this is due to a high heat conductance of glass as compared with that of the loose mass of the adsorbent. The heat energy, distributed from the external heater directly to the walls of the calorimeter vessel, is conducted along the glass and warms up two heavy glass tube connections between the calorimeter vessel proper and the exterior of the calorimeter before an equilibrium is established through the mass of the adsorbent with the thermo-

couples.<sup>1</sup> The external heater was therefore replaced, as mentioned before, by an internal one. This was surrounded on all sides by the adsorbent, and the energy liberated in the heater could not be conducted away except through the adsorbent. Thus conditions prevailing during an adsorption process were very closely approximated. The thermal equilibrium with this arrangement was established much more rapidly than with the external heater and required only a few more minutes than in the process of adsorption.

*Reversibility of Adsorption.*

One of the striking features of these results here reported is the magnitude of the heats of adsorption. They attain 30,000 cal. and more for hydrogen, sulfur dioxide, and carbon monoxide, and increase beyond 100,000 cal. for oxygen. Such values are, however, not in disagreement with the results obtained elsewhere. Thus Langmuir<sup>2</sup> estimated the heat of adsorption of carbon monoxide to be of the order of 30,000 cal. Carbon monoxide, according to Langmuir, begins to come off the surface in vacuum at 350-400°, whereas oxygen cannot be removed below 1200°. One might therefore expect the heat of adsorption of oxygen to be much higher than that of carbon monoxide. That Ramsay, Shields, and Mond<sup>3</sup> obtained lower values throughout is not astonishing because these investigators did not degas their adsorbing materials thoroughly and measured, therefore, only the last sections of the adsorption isotherms where our measurements also yielded lower values.

Observations of Langmuir on the reversibility of adsorption are fully confirmed by these experiments: Nos. 3 and 4 show that oxygen is not removed at 350° to any appreciable extent; Nos. 16 and 17 show that carbon monoxide at 350° can be removed partially from the surface in vacuum. Sulfur dioxide behaves like carbon monoxide, and a fraction of the adsorbed gas is removed at 350°. Hydrogen is most easily removed from the surface. Of course, the reproducibility of hydrogen adsorptions is no proof to that effect, since the platinum surfaces were in contact with hydrogen prior to the experiments, and it might have been retained throughout the experimental series in large but more or less unchanging amounts. Evidence favoring the above assumption is furnished by Experiments Nos. 26 and 27. Other experiments (see Nos. 10 and 13) show that the heat evolved, when oxygen comes in contact with the hydrogen-covered platinum surface, is considerably greater than when it is adsorbed on a degassed surface. If on the degassed surfaces a large quantity of hydrogen remains, an increase of this quantity by a small additional amount could not appreciably affect the heat evolution on admission of oxygen. If, on the other hand, very little hydrogen remains (relative to the total adsorptive capacity) even a small additional adsorption

<sup>1</sup> It should be pointed out here that this complication is not so serious in the case of the earlier type of calorimeter. In that apparatus the calorimeter vessel, being connected with the exterior through one thin glass tubing only, was much better heat-insulated, as indicated also by the cooling rates being much slower than with the new calorimeter.

<sup>2</sup> J. Am. Chem. Soc., 40, 1361 (1918).

<sup>3</sup> Z. physik. Chem., 25, 657 (1898).

of this gas could markedly increase the evolution of heat on admission of oxygen. This latter situation prevailed in Experiment No. 27, after only 0.4 cc. of hydrogen (about 7 per cent of the amount which is adsorbed at saturation) had been admitted to the adsorbent. One may thus conclude, disagreeing somewhat with Benton,<sup>1</sup> that a thorough degassing at 250°, and particularly at 350°, removes from the platinum surface almost all adsorbed hydrogen. Still, the fraction remaining is probably not immeasurably small, as will be seen also from the following.

Observations on the rate of degassing yield also the evidence that this rate is not completely determined by the heat of adsorption. For instance with platinum black No. 2, more than 5 cc. of hydrogen with heats of adsorption in excess of 20,000 cal. (except No. 12) can be removed by degassing at 250° for four hours. In the case of sulfur dioxide, out of 6.5 cc. with heats larger than 20,000 cal., only 3.5 cc. are removed by degassing at 350° (Expt. Nos. 22 and 23). Carbon monoxide is held even more tightly on the surface, as shown by Experiments Nos. 16 and 17; only 0.7 cc., out of 21.7 cc. with heats higher than 20,000 cal., are removed by degassing at 350°. With platinum black No. 3 it was found that degassing at 250° failed to remove sulfur dioxide even with heats of adsorption less than 20,000 cal. although hydrogen, with appreciably higher heats of adsorption, could be pumped off at this temperature. Such differences in the rate of desorption can hardly be accounted for by assuming a varying efficiency of mercury diffusion pumps. The varying diffusion rate of the gases through the mass of the adsorbent cannot be used as an explanation either, because the most slowly removed gas is carbon monoxide, whereas the one most slowly diffusing is sulfur dioxide. Besides, the differences in the rates of diffusion are too small to account for the observed phenomena. One is forced therefore to the conclusion that the true rate of evaporation from the surface must be influenced by other factors besides the heat of adsorption to a very considerable degree.

*The Heat Treatment and the Adsorptive Activity.*

The effect of extended heating on the adsorption characteristics of the three platinum blacks studied is not the same. Heating to 350° gradually destroys the adsorptive capacity of black No. 1, reducing the hydrogen adsorption to almost nothing and decreasing the adsorption of oxygen nearly as much. Blacks Nos. 2 and 3, on the other hand, withstand a similar heating much better. Their adsorptive capacities for hydrogen and for oxygen are reduced considerably by the first degassing at 350°, but the subsequent heatings to the same temperature have only a small influence on the amounts of gases adsorbed. On these blacks, as on No. 1, adsorption of hydrogen is decreased more than that of oxygen. With all three adsorbents heating destroys preferentially that part of the adsorption which is accompanied by larger heat evolution so that, as the net result, a general decrease in the heats of adsorption is observed. In the visual appearance after heat treatments the black No. 1 differed also from the other two: toward the

<sup>1</sup> J. Am. Chem. Soc., 48, 1850 (1926).

end of the measurement series it was quite sintered and almost metallic gray whereas the other two retained their dark color practically unchanged, although sintering somewhat.

*The Mode of Preparation and the Adsorptive Activity.*

The profound influence of the method of preparation on the adsorptive capacity of platinum blacks for a gas is known from earlier work and is clearly seen from the tables here presented. It need not be discussed further. Of more interest is the observation that the method of preparation does not affect the adsorptive capacities of the blacks for different gases in the same degree. This is demonstrated by the following Table 36, in which some of the pertinent results have been gathered. The choice of the data may appear somewhat arbitrary, but it is easy to convince one's self that the essential character of the conclusion reached is not affected by the choice of the data. Oxygen and hydrogen adsorptions are in this table given at a pressure of 50 mm. at which pressure the main adsorption is completed. With sulfur dioxide the adsorption isotherms were followed only to a pressure of a few mm. since on further increase of pressure this gas might have condensed in the mercury trap cooled by a solid carbon dioxide-ether mixture. The data of Table 36 for sulfur dioxide are calculated therefore for a pressure of 2 mm. only.

TABLE 36  
Ratio of adsorbed gas quantities

Gas	Black No. 1 Prior outgassing	cc. adsorbed	Ratio O <sub>2</sub> /H <sub>2</sub>	Ratio O <sub>2</sub> /H <sub>2</sub>
H <sub>2</sub>	15 hr. at 350°	2.0	—	—
O <sub>2</sub>	20 " " "	6.0	3	—
H <sub>2</sub>	30 " " "	0.45	—	—
O <sub>2</sub>	34 " " "	1.76	4	—
SO <sub>2</sub>	40 " " "	1.1	—	1.6
No. 2				
H <sub>2</sub>	5 hr. at 250°	21.0	—	—
O <sub>2</sub>	10 " " "	58.0	3	—
H <sub>2</sub>	41 " " 350°	6.0	—	—
O <sub>2</sub>	37 " " "	49.0	8	—
SO <sub>2</sub>	45 " " "	18.0	—	2.7
No. 3				
H <sub>2</sub>	3 hr. at 250°	28.0	—	—
O <sub>2</sub>	7 " " "	11.5	0.4	—
H <sub>2</sub>	26 " " 350°	12.0	—	—
O <sub>2</sub>	27 " " "	12.0	1	—
SO <sub>2</sub>	28 " " "	5.0	—	2.4

Although the exposure to high temperatures changes considerably the ratio of gases adsorbed on the same black, these changes are small, when ratios obtained on different blacks are compared. From Table 36 it is seen that the ratio of amounts of hydrogen and of oxygen adsorbed on platinum may differ by as much as twenty-fold on different blacks, suggesting that the simple and constant ratio obtained by Benton<sup>1</sup> was entirely accidental. The ratio of hydrogen to sulfur dioxide (not shown in Table 36) changes by as much as six-fold, whereas the ratio of oxygen to sulfur dioxide remains fairly constant. Whether this latter feature is real or also of accidental nature cannot be decided at present.

*Reactions on the Surface.*

A comparison of the heats of adsorption of hydrogen on degassed platinum and on platinum covered by oxygen indicates that these processes are entirely different, and that in the second case reaction must occur. Such a conclusion is quite in accord with known facts on the catalytic activity of platinum in the water synthesis. The heat evolution in the case of an oxygen-covered surface is not, of course, the heat of combustion of the gaseous elements. It is rather equal to the heat of combustion (58,000 cal.) minus one half of the heat of adsorption of oxygen plus the heat of adsorption of water. Since all values except the last are known, an estimate of the magnitude of this one can be made. Unfortunately, this calculation cannot be very exact because, when adsorption is as strong as that of oxygen, it is very questionable whether the measured heats are the true differential heats. It is more likely that the lower layers of the mass of the adsorbent in the calorimeter begin to adsorb only after the top layers have become nearly saturated. Accordingly, the measured heats lie somewhere between the true differential heats and the integral heat of adsorption. The same situation, and to a similarly unknown degree, exists with respect to the reaction of hydrogen with adsorbed oxygen. By reason of this complication one cannot calculate the differential heats of adsorption of water, and only the integral heat, using the averages for oxygen on platinum black and for hydrogen on O<sub>2</sub>-covered platinum, can be estimated.

On platinum black No. 1 one may take, as the average of runs Nos. 3 and 5, 49,000 and 35,000 cal. respectively. The heat of adsorption of water vapor is calculated from these values to be +1,000 cal., i.e. essentially zero. In the case of black No. 2, excessively large values for the heat of adsorption of oxygen have been obtained in run No. 10 after a short degassing period. This is very likely due to small amounts of hydrogen left on the surface. Indeed, runs made with another sample of black No. 2 (not represented here), after slightly longer degassing, gave oxygen values dropping very rapidly to about 100,000 cal. and staying nearly constant there, although this other sample yielded hydrogen values identical with those determined in Experiment No. 9. This is a definite indication that the values of Experiment No. 10 are rather too high owing to reaction with some hydrogen left on the

<sup>1</sup> J. Am. Chem. Soc., 48, 1850 (1926).

surface. As the basis of calculations, the value of 104,000 cal.—the last one in Experiment No. 10—shall be taken. As the heat of reaction on the surface (Experiment No. 11), 90,000 may be taken, although this value may be too high. The heat of adsorption of water vapor becomes then 84,000 cal. A check on this value is offered by the consideration that the heat of adsorption of water can also be calculated from the heat of adsorption of hydrogen on degassed platinum and the heat of reaction of oxygen with adsorbed hydrogen. The first two data are furnished by Experiments Nos. 9 and 13. As the heat of adsorption of hydrogen, 20,000 cal. shall be taken; as the heat of reaction (of one-half mole of oxygen), 108,000 cal. The resulting heat of adsorption of water vapor is 70,000 cal. Considering the uncertainties involved in all these calculations, the agreement obtained is not bad.

On platinum black No. 3 the heat of adsorption of water is calculated to be 42,000 cal. if the data of Experiment No. 26, with an average of 80,000 cal., and of Experiment No. 28, with an average of 60,000 cal., are taken.

On blacks Nos. 2 and 3 the differential heats of adsorption of water vapor should be, according to the data of the previous tables, higher initially than calculated above, but should drop to lower values finally. On black No. 1, on the other hand, the heat remains essentially equal to zero throughout the run. This different behavior of the blacks towards the water vapor, as well as the unusually high values of the heats of adsorption calculated for blacks Nos. 2 and 3, are very startling. They do not agree at all with the unquestionable fact that water can be removed from the surface at 250° and perhaps even below. The authors are quite unable to suggest an explanation as to why water vapor with heats of adsorption up to 70,000 or 80,000 cal. is easily removed at 250°, whereas carbon monoxide with heats below 40,000 cannot be removed at 350°. Although these facts seem to contradict established principles of thermodynamics, they can hardly be due to experimental errors. In fact, the measured heats of adsorption on black No. 2 must be reduced to one-half their present value, and even to less, in order to obtain more plausible values for water of the order 10,000-20,000 cal., and in this case, as will be shown presently, other unsurmountable difficulties arise. The data presented in Tables Nos. 16 and 18 make possible a calculation of the heat of adsorption of carbon dioxide on black No. 2. That one is dealing here with oxidation of carbon monoxide and not with substitution of carbon monoxide by oxygen on the surface can be deduced from Experiments Nos. 14, 16, and 18.<sup>1</sup> The heat of adsorption of carbon monoxide is 25,000 cal. on the average, that of oxygen on the degassed surface about 65,000 cal. Since about as much gas is given off by the surface in Experiment No. 18 as is adsorbed, the resultant heat evolution should be equal to  $65,000 - 25,000 = 40,000$  cal., whereas values in excess of 70,000 cal. have been observed. It is thus more than likely that a chemical reaction does take place and that the liberated gas is carbon dioxide. Calculating its heat of adsorption, by the method employed in connection with water vapor, a value of -6,000

<sup>1</sup> Cf. also Langmuir: *J. Am. Chem. Soc.*, 40, 1398 (1918).

cal. is obtained, if for the heat of reaction on the surface 37,000 cal. (for one-half mole of oxygen) is taken. The value thus obtained is rather too small because a small fraction of oxygen may have remained in the gas phase and because the calculation assumes that all carbon dioxide remains adsorbed, whereas in reality a large fraction of it—about one-half—evaporated from the surface. When these corrections are considered, a small positive heat of adsorption appears very probable. Such a value is substantiated by the weak adsorption of carbon dioxide on platinum.

The results of the calculation of the heat of adsorption of carbon dioxide provide further evidence that the heats of adsorption as used in calculations for water vapor are not too high. Should they be decreased, a large *negative* heat of adsorption of carbon dioxide would result.

The results of experiments with sulfur dioxide and oxygen are not very conclusive. It is evident only that oxygen does not remove sulfur dioxide from the surface but is either adsorbed together with it or reacts forming sulfur trioxide. Which of these two possible processes does take place cannot be decided. One may assume provisionally that a reaction does occur and calculate the resulting heats of adsorption of sulfur trioxide. With platinum black No. 2 in Experiments Nos. 22 and 24, 27,000 cal. is thus obtained, if the heat of adsorption of sulfur dioxide is taken equal to 25,000 cal., and the heat of reaction on the surface equal to 50,000 cal. With black No. 3, 25,000 cal. results when the heat of adsorption of sulfur dioxide is assumed to be equal to 17,400 cal. (Expt. No. 33) and that of the reaction 61,000 cal. (Expt. No. 35).

#### Conclusion

An important general question, how the presence of one adsorbed substance affects the adsorption of another, has not been touched upon in the preceding discussion. Although the experiments here presented offer considerable data in this connection, their discussion will not be attempted as no regularities could be detected. It is certain only that, on the whole, the presence of one molecular species on the surface in almost its saturation amount does not prevent the adsorption of large amounts of another kind of molecule.

In earlier work<sup>1</sup> Kistiakowsky has found that the curves of the differential heats of adsorption of hydrogen and carbon monoxide on copper showed pronounced minima in the beginning. This phenomenon was not encountered during the present work. The theory of minima, originally suggested, met with serious thermodynamic objections, as was pointed out by Kistiakowsky, Flösdorf, and Taylor and also by Polanyi and Welke. The present work shows that there is no immediate connection between minima in the heat curves and the catalytic activity of the adsorbent material. The minima, as observed by Fryling, by Kistiakowsky, by Garner and McKie, and by Polanyi, must rather be considered as a phenomenon specific for a given adsorbent and adsorbate.

<sup>1</sup> Z. physik. Chem., 132, 371 (1928).

When a comparison is made between the various properties of the three platinum preparations as described in Parts I and II of the present work, a distinct parallelism will be observed between catalytic activity of the samples and their more physical properties. Thus sample No. 1 is the poorest catalyst, has the coarsest structure, and is the poorest adsorber. In hydrogenation of ethylene the catalytic activity decreases in the order Nos. 3, 2, 1. The quantities of hydrogen adsorbed as well as the heats of hydrogen adsorption decrease in the same order. For oxidation reactions the order of effectiveness of the samples is Nos. 2, 3, 1, and the adsorptive characteristics toward oxygen stand in the same order. One might be tempted to develop more quantitative relationships, but such a step would be premature. Further work on other properties is needed to explain the specific catalytic effect of many substances, e.g., the complete inactivity of platinum or copper in the methanation of carbon monoxide, a reaction readily brought about by nickel and to some extent by palladium.<sup>1</sup> No clue is of course obtainable for such cases from the present work since we have worked with only one substance.

#### Summary

1. Differential heats of adsorption of hydrogen, oxygen, sulfur dioxide, and carbon monoxide have been measured on three differently prepared platinum blacks.
2. The reversibility of adsorption, the effect of heat treatment on adsorption, and the effect of the mode of preparation on the adsorption characteristics of the blacks are discussed.
3. The data presented allow calculations of the heats of adsorption of water, carbon dioxide, and sulfur trioxide.
4. In the three samples of platinum black studied, the catalytic activity runs parallel to adsorptive characteristics.

<sup>1</sup> Sabatier and Reid: "Catalysis", 506, 522, 534 (1922).



# THE ORIGIN OF THE CHEMICAL ELEMENTS

BY S. BRADFORD STONE

## I. Introduction

A recent improvement in the design of the mass spectrograph has enabled Aston to determine the atomic weights of several individual physical atoms to within one or two parts in ten thousand.<sup>1</sup> The new values are accurate enough to be used as criteria for estimating the possibility of hypothetical transformations, or decompositions, of the various atomic species. This can be done by means of the relation between mass and energy given by the special theory of relativity. The energy involved in even a small change of mass is of such greater magnitude than the usual types of energy changes considered in thermodynamics, that the criterion for an atomic transformation reduces to the condition that the mass of the resultants must be less than the mass of the reactants. An illustration of the above reasoning has been given for the radioactive decomposition of thorium.<sup>2</sup> The difference per gram atom between the weight of the thorium atom, and the combined weights of the decomposed thorium atom and the expelled alpha particle can be estimated from Aston's curves as 0.0068 grams. If this energy is transferred entirely to the alpha particles, then each particle carries a kinetic energy of  $1.01 \times 10^{-6}$  ergs, a value approximately equal to those involved in radioactive transformations. The application of Einstein's equation to Aston's data therefore predicts, to well within the experimental error, the maximum available energy of radioactive decomposition. Another deduction is that, in general, only the heavier atoms can undergo spontaneous alpha particle decomposition. For the lighter atoms such changes involve an increase in mass and are therefore forbidden.

The explanation of the origin of the cosmic rays given by Millikan and Cameron assumes that atoms are being formed in interstellar space through the union of hydrogen particles. For convenience this hypothesis will be designated as the hydrogen system. One point in connection with this system which has never been stated explicitly, is that it offers a reasonable account of the hithertofore anomalous position of the radioactive elements. Previous theories of the evolution of the elements have failed to explain how an atom which is unstable with respect to atoms of lower weight can be formed by the union of such lighter atoms. Thermodynamic considerations offer two possible explanations. One is that these elements are created in a thermodynamic environment where they have less tendency to decompose. This limits the possible sites of formation either to interstellar space, with its low temperatures; or to stellar interiors. The second possibility is that these elements are of the nature of intermediate products. This follows directly

<sup>1</sup> F. W. Aston: Proc. Roy. Soc., 115, A, 487 (1927); J. L. Costa: Ann. Physique, 4, 425 (1925).

<sup>2</sup> R. A. Millikan and G. H. Cameron: Phys. Rev. (2), 32, 537 (1928).

from the hydrogen system. The formation of a radioactive atom from hydrogen is accompanied by a decrease in mass. Dissociation into lighter atoms also results in a decrease in mass. Both the formation and the dissociation are thermodynamically possible. The same explanation of the synthesis of the radioactive elements applies to the kinetic hypothesis of atomic formation which will be presented later.

#### A Possible Test of the Theory of Relativity

It has been shown that an improved accuracy in mass spectra measurements would permit a new test of the theory of relativity. In the change<sup>1</sup> from Ra A to Ra G there is a decrease in mass due to the liberation of five alpha particles, and of four electrons. There should also be a further decrease equal to the mass equivalent of the liberated energy. Chemical data cannot be used because of the possibility of contamination by isotopes. Mass spectra examination of the radioactive elements is subject to several difficulties. If these can be overcome, then the new measurements are sufficiently accurate to yield direct evidence on this question.

#### An Equation for the Atomic Weights

It has been stated that the mass defect  $D$  is proportional to the atomic weight  $A$ , if both  $D$  and  $A$  are calculated<sup>2</sup> on the basis of hydrogen equal to unity. This equation is of no use for estimating an unknown atomic weight, since it can be shown to be a restatement of the conclusion that the physical atomic weights are whole numbers if oxygen is taken as 16.000. For all but a few of the lighter atoms this is true to within less than one part in one thousand.

Starting with the assumption that

$$P = W$$

where  $P$  is the protonic number, and  $W$  is the atomic weight on the usual basis.

$$P - W/1.0078 = 0.0078W/L. 1.0078$$

$$P - A = 0.0077 A \text{ or}$$

$$D = 0.0077 A$$

Using Strumm's data the average value of his constant of proportionality is 0.0078, which is identical with the value calculated on the assumption that the atomic weights are whole numbers on an oxygen basis. The equation is therefore merely a restatement of this fact.

#### Objections to a Hydrogen System

The assumption that iron is formed by the union of protons (or neutrons) requires that 56 such particles meet in the minute volume of an atomic nucleus, and then release their energy of union in a single quantum jump. Since iron is an abundant element this reaction would have to be of frequent occurrence. Any hesitancy concerning such an hypothesis becomes still greater for the heavier atoms where it is necessary to postulate the union of more than two hundred particles. Probability considerations do not favor

<sup>1</sup> King: Nature, 109, 582 (1922).

<sup>2</sup> Strumm: Z. Physik, 50, 555 (1928).

a hydrogen system. If there is a certain possibility of the union of four protons (neutrons) to form helium, then the possibility of the union of fifty-six such particles to form iron would appear to be an infinitesimal of a very high order. The hydrogen system would seem to require that atomic abundance should decrease very rapidly with increasing atomic weight, and that atoms as heavy as iron should have nearly zero abundance.

## II. The Helium, Hydrogen System

In view of the objections to a hydrogen system it would be of interest to determine to what extent the same facts can be interpreted on the assumption that the formation of atoms occurs through the combination of helium and hydrogen nuclei. This hypothesis has the advantage of reducing sharply the number of units concerned. For the more abundant atoms the number of reacting particles is only one fourth of the number necessary on the hydrogen system.

A better reason for the adoption of a helium, hydrogen system lies in the fact that such a hypothesis is supported by evidence from several different chemical and physical sources. A complete discussion of this subject can be found in the works of Harkins.<sup>1</sup> The evidence can be summarized as follows:

a) The most abundant atoms in the earth's surface, and in meteorites have nuclei which can be represented as composed solely of alpha particles. For these atoms the number of protons in the nucleus is divisible by four, and the number of nuclear electrons is one half that of the number of protons; that is the ratio of nuclear electrons to protons is the same as that of the alpha particle. Such atoms compose 76.5% of the atoms in the crust of the earth, and 91.7% of those in meteorites.

b) Alpha particles are expelled in radioactive decomposition.

c) Hydrogen atoms are released in alpha particle impacts on atomic nuclei. Atoms whose atomic weights are multiples of four are most stable towards a hydrogen decomposition.

d) The alpha particle can attach itself directly to an atomic nucleus.<sup>2</sup>

A new type of evidence may result from the development of the wave mechanics. When this theory is applied to band spectral data, it is found that helium shows no nuclear spin. The same is true of  $O^{16}$ , which agrees with the hypothesis that the oxygen nucleus is composed of four alpha particles. Both hydrogen, nitrogen, and fluorine have nuclear spins, in agreement with the supposition that the nitrogen and fluorine nuclei contain protons.<sup>3</sup>

### Basic Assumptions of the Kinetic Hypothesis

It is intended to show that certain assumptions concerning the mechanism of atomic formation lead to a helium, hydrogen system of the various atomic species, and that such a system is able—

1) to set a upper limit to the atomic weight.

<sup>1</sup> W. D. Harkins: Chem. Rev., 4, 393 (1928) an excellent summary of Harkins' theory.

<sup>2</sup> Blackett: Proc. Roy. Soc., 107A, 349 (1925).

<sup>3</sup> W. Heisenberg: Z. Physik, 38, 411 (1926); 41, 26 (1927); H. G. Gale and G. S. Monk: Astrophys. J., 69, 77 (1929).

2) to account for the known facts regarding atomic abundance.  
 3) to interpret the cosmic radiation. The following assumptions will be set forth explicitly as being fundamental to the new system.

a) In those portions of space where atomic formation takes place, hydrogen is by far the most abundant element.

b) Helium is formed directly from hydrogen and ranks second in abundance. These two statements apply only to the site of atomic synthesis. In stars, nebulae, or planets the abundance of helium and hydrogen is less because of their consumption in the formation of the other elements. Assumptions a) and b) are supported by spectroscopic evidence which indicates the abundance,—possibly even in excessive amounts, of both hydrogen and helium in all stars.<sup>1</sup> For all reactions leading to the formation of atoms, the following assumptions will be made:

c) The most important factor in the abundance of any reaction is the kinetic factor. Reactions involving a large number of particles will in general be less probable than those involving a smaller number.

d) Any reaction can occur if there is a decrease in mass. Reactions in which the mass increases can not take place.

e) Reactions between similar nuclei are more probable than those between different nuclei. Of these postulates c) and d) are a priori reasonable, while e) is purely an assumption, and can only be justified if it leads to correct results. It will be shown later that this assumption (e) follows directly from a certain hypothesis concerning the nature of atomic synthesis. The above assumptions do not limit the possible reactions to the union of hydrogen and helium nuclei. Changes such as

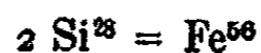

are accompanied by a decrease in mass and are theoretically possible. Although such reactions are not prohibited, they would, because of the relative scarcity of the reacting atoms be expected to be of less frequent occurrence.

It has been postulated that hydrogen is by far the most abundant element; and also that the kinetic factor or the number of reacting units determines the abundance of a reaction. Transformations involving only hydrogen nuclei should therefore be of more frequent occurrence than reactions involving the same number of helium nuclei. The formation of  $\text{Fe}^{56}$  from helium requires the union of sixteen helium particles. In view of the greater abundance of hydrogen, the reaction

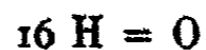

should be of more frequent occurrence, and a certain portion of the known oxygen atoms should have been formed in this manner. For the same reason the synthesis



would be expected to create a number of iron atoms greater than the initial

<sup>1</sup>C. H. Payne: "Stellar Atmospheres", 188.

number of  $U^{238}$  (61 reacting units). Since both uranium, and its decomposition products have only a vanishingly low abundance; the number of iron atoms thus formed would be expected to be small.

### The Kinetic Hypothesis

We have been led to the following view of the nature of atom formation. All reactions associated with a decrease of mass can take place. The most important are the union of hydrogen nuclei alone, or of helium nuclei alone. The union of  $n$  hydrogen nuclei is more probable than the union of the same number of helium particles. Reactions involving a mixture of helium and hydrogen units can take place in more than one manner, i.e.,  $Na^{23}$  can be formed by

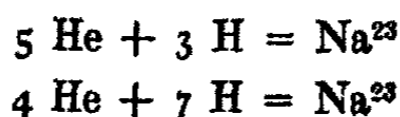

or by similar changes. Syntheses involving heavier nuclei are not common because of the lower abundance of the reactants.

The new system is therefore to be regarded as a kinetic hypothesis in which all possible types of collisions and reactions can occur. The abundance of any atomic species will depend partly on the nature of the reactions leading to its formation, i.e., the number and type of reacting units; and partly on specific conditions connected with the reaction itself, and with the stability of the reaction products. It will be convenient to give to this system the name *kinetic hypothesis*, which also serves to distinguish it from the helium, hydrogen system of Harkins. The following nomenclature will be used. A reaction in which only H (He) units are concerned will be called a hydrogen (helium) reaction. When a mixture of helium and hydrogen units are concerned, the reaction will be called a mixed reaction.

The requirement of alternative processes for the formation of any one atom raises the interesting speculative possibility of differences between individual atoms. In terms of the wave mechanics it might be expected that an atom formed from hydrogen alone would have a nuclear spin, while the same atom formed by a helium reaction would have zero spin. Another possibility is that alternative methods of formation might produce atoms of slightly different weights. This would mean that the individual mass spectra lines have a fine structure. This possibility might be tested by examining single lines under the greatest attainable dispersion.

### Calculation of Mass Decrease

Before proceeding, an example will be given of the calculation of the decrease in mass attending the formation of an atom by a mixed reaction. From Aston's measurements we have

$$\begin{aligned} Cl^{35} &= 34.9830 \\ \text{H} &= 1.00778 \\ \text{He} &= 4.00216 \end{aligned}$$

If  $\text{Cl}^{35}$  is composed of 8 He and 3 H nuclei then its calculated weight is

$$8 \times 4.00216 + 3 \times 1.00778 = 35.0407$$

The decrease in mass due to the mixed reaction is equal to

$$34.9830 - 35.0407 = -0.0577$$

For convenience this will be multiplied by  $10^4$  and designated as  $\Delta m$ .

#### The Upper Limit of Atomic Weight

In Fig. 1 the value of  $\Delta m$  has been plotted against  $P$ , the number of protons in the nucleus. The data is divided into four groups for which  $P$  can be represented by the equations.

$$P = 4K + N$$

$$(N = 0, 1, 2, 3)$$

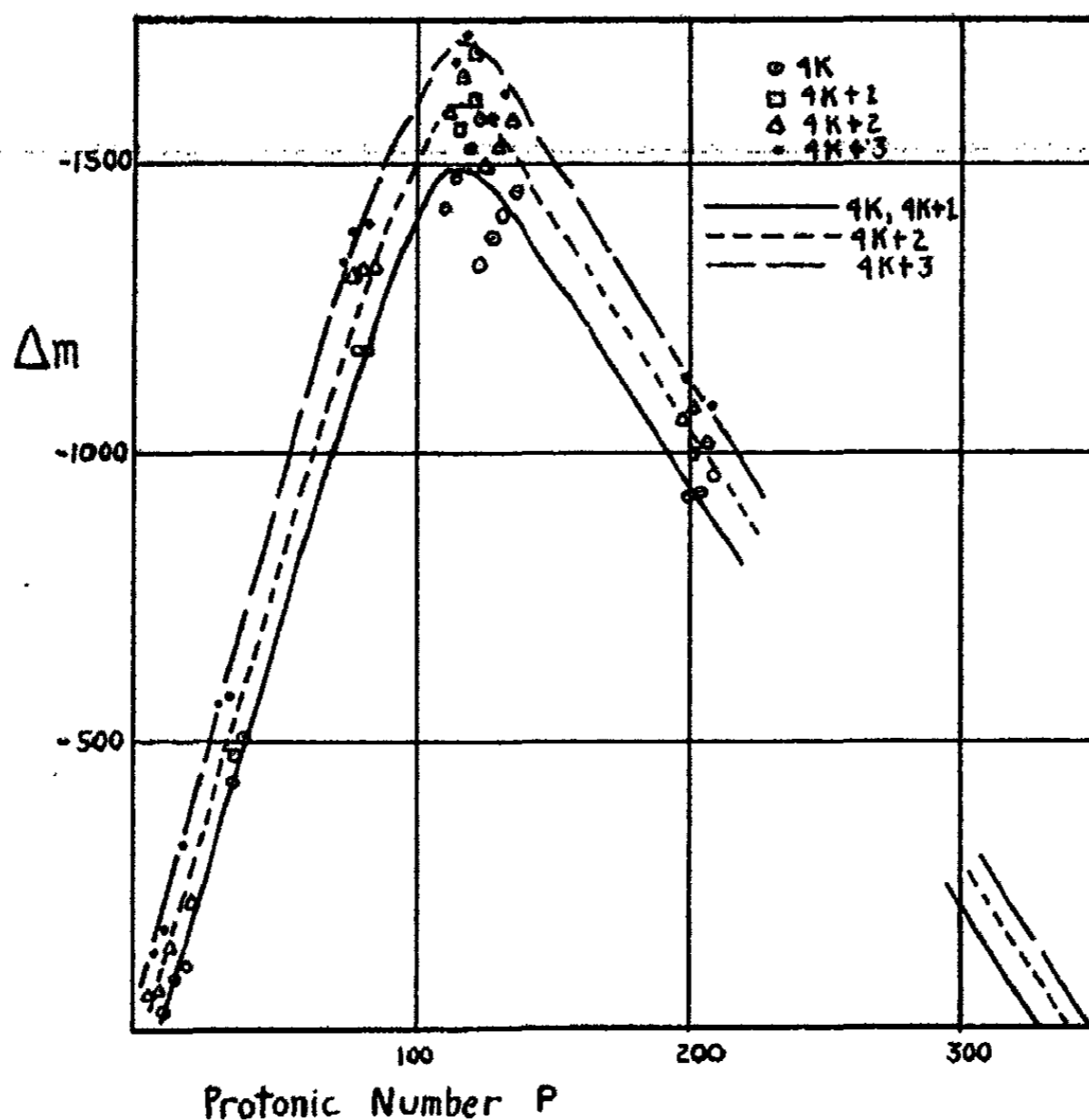

FIG. 1

It will be seen that the absolute value of  $\Delta m$  goes through a maximum with increase of  $P$ , and for each group falls to zero at a value of  $P$  greater than 238. The kinetic hypothesis therefore sets a practical upper limit to the complexity of atomic nuclei. For the heaviest known atom  $\text{U}^{238}$  the value of  $\Delta m$  is  $-520$ , so that the theory provides for the formation of all known atoms. The probable errors in Aston's data for the heavier atoms range from 0.02 to 0.04 units of atomic weight. Only by making the most unfavorable assumptions

concerning the possible errors can the maximum be reduced below 238. The possibility of hydrogen reactions for the formation of the heavier atoms does not lead to any modification of these ideas. Such reactions are theoretically possible since they are accompanied by large decreases in mass. However if the union of 61 particles to form  $U^{238}$  is an infrequent event, then the union of more than 238 hydrogen nuclei to form an atom heavier than uranium should be of an infinitely lower order of frequency. The kinetic hypothesis does not set an absolute limit to the atomic weight, but it does establish a practical upper limit; in that no atom of weight greater than about 340 can be formed by a helium reaction, while the possibility of the union more than 238 hydrogen particles is infinitely small.

#### The Abundance of the Various Atomic Species

Before applying the kinetic hypothesis to the question of atomic abundance, an attempt will be made to show that accepted facts and theories indicate that the composition of the earth's crust can be regarded as representative of that of all known matter, and that at least any general conclusion based on this data can be regarded as essentially correct. Knowledge of atomic abundance comes from only three sources: spectral data for stars and nebulae, and chemical analyses of the earth's crust, and of meteorites.

The enormous extent of the various nebulae indicate a relatively high extent for their constituent elements, of which the most abundant are H, He, O, N, and C (weak). The hypothetical element nebulium has been shown to be due to N and O. It will be noticed that all these atoms are of low atomic weight.

Stellar spectra are divided into several classes. The approximate uniformity within any given class shows at least a corresponding uniformity of surface composition. This may correspond to a similarity of internal composition since any pronounced internal differences would, because of effects due to radiation pressure, be expected to produce observable differences in some stars. The differences between the various classes of stellar spectra are interpreted as due primarily to changes in surface temperatures, and not to any variation in chemical constitution.<sup>1</sup>

The uniformity of composition may extend further than the surface of the stars, for Eddington has pointed out that the theorem of H. van Zeipel indicates the existence of both surface and internal convection currents flowing along the stellar meridians. These currents should be effective in producing a somewhat uniform composition of the entire star.<sup>2</sup>

The six most abundant elements in the stars as estimated by the method of Fowler and Milne<sup>3</sup> are Si, Na, Mg, Al, Ca, and Fe respectively. The same metals in the order Si, Al, Na, Fe, Ca, and Mg make up the six most abundant metals in the crust of the earth. The metals are chosen for comparison be-

<sup>1</sup> C. H. Payne: "Stellar Atmospheres"; J. H. Jeans: "Astronomy and Cosmogony", 22 (1928).

<sup>2</sup> A. S. Eddington: M. N. R. A. S., 88, 73 (1925); H. van Zeipel: 84, 665; Rosseland: 89, 49 (1928).

<sup>3</sup> C. H. Payne: "Stellar Atmospheres."

cause of their better spectral lines. A list of the fourteen most abundant elements in the stars shows thirteen of the fourteen most abundant in the earth. The only discrepancy is in the case of zinc which is more abundant in the stars than in the earth. Every element listed by Payne as possibly missing in stellar spectra has an abundance in the earth of less than 0.01 atomic percent. Stellar spectra do not show any elements which are unknown to the earth.

Knowledge of the composition of the earth is limited to the first few miles of the crust. Because of the difference in density between the outer crust and the earth as a whole (2.7 and 5.5), it is often assumed that the heavier metals constitute a large portion of the earth's interior. There is no good evidence that bears on this question. The estimated temperature and pressure at the center of the earth are 16,600°C and 2,800,000 atmospheres, and lie far outside the range of experimental knowledge.<sup>1</sup> The heaviest elements however appear to be less abundant in the earth's interior. The average fraction of radium igneous rocks, a type which constitutes 95% of the lithosphere, is  $1.7 \times 10^{-12}$ . This is twenty-eight times the amount necessary to account for the measured temperature gradient of the earth.<sup>2</sup>

Data on the composition of meteorites when averaged to take account of the relative number of stone and iron meteorites show much the same results as found for the earth's crust.<sup>3</sup> The only differences consist in larger amounts of Ni, Fe, and Co in the meteorites. The elements Ni, and Cl have been found to show the same isotopic composition in the meteorites as in the terrestrial elements.<sup>4</sup>

These various types of evidence all support the statement that the earth's outer crust has in general much the same chemical nature as the meteorites, and the outer layers of the stars; and in addition indicate the possibility that the resemblances may extend below the surfaces of the stars, and that the composition of the earth may be representative of that of all known matter. Any general conclusions concerning the earth's crust should therefore furnish valuable material for speculations concerning the formation of the elements.

The most important of such relationships is that of the concentration of matter into the lighter elements as shown in Table I.<sup>5</sup>

TABLE I

Atomic number	Atomic percentage in the earth's crust	Atomic number	Atomic percentage in the earth's crust
1 - 8	67.11	1 - 16	95.93
9 - 16	27.88	1 - 16	5.04
17 - 24	3.30	33 - 92	0.03
25 - 32	1.74		
33 - 92	0.03		

<sup>1</sup> Lunn: "Tidal and other Problems", 201 (1909).

<sup>2</sup> F. W. Clarke: "Data of Geochemistry", Bull. 491, U. S. Geol. Survey, p. 301.

<sup>3</sup> W. D. Harkins: Phil. Mag., 42, 305 (1921).

<sup>4</sup> W. D. Harkins and S. B. Stone: J. Am. Chem. Soc., 48, 938, (1926).

<sup>5</sup> W. D. Harkins: Chem. Rev., 4, 393 (1928).



It will be seen that there is an excessive concentration of matter in the lighter atoms. This is to be expected from the kinetic hypothesis, since the most common atomic syntheses would be those involving small numbers of reacting units.

The elements show a striking preference for species whose protonic number can be represented by  $4K$ , where  $K$  is an integer. (See Table II).

TABLE II  
Atomic Abundance

Atom	$4K$	$4K + 1$	$4K + 2$	$4K + 3$
O <sup>16</sup>	57.44			
Si <sup>28</sup>	16.48			
Si <sup>29</sup>		1.75		
Al <sup>27</sup>				5.55
Na <sup>23</sup>				2.27
Fe <sup>54</sup>			0.13	
Fe <sup>56</sup>	1.55			
Ca <sup>40</sup>	1.55			
Ca <sup>44</sup>	0.13			
Mg <sup>24</sup>	1.22			
Mg <sup>25</sup>		0.19		
Mg <sup>26</sup>			0.18	
K <sup>39</sup>				1.16
K <sup>41</sup>		0.06		
Ti <sup>48</sup>	0.27			
C <sup>12</sup>	0.15			
Totals	78.79	2.00	0.31	8.98

If hydrogen with its abundance of 9.48 is excluded, the above totals would be 87.04, 2.22, 0.34, and 9.92, a total of 99.52%. The overwhelming concentration of matter in the  $4K$  type atoms finds an obvious explanation in terms of the kinetic hypothesis. Of the  $4K$  type atoms, O<sup>16</sup>, Si<sup>28</sup>, Ca<sup>40</sup>, Mg<sup>24</sup>, and C<sup>12</sup> have a ratio of nuclear electrons to protons equal to 0.500, the same value as that of the alpha particle. These atoms make up 76.48% of the total atoms of the earth's crust, or excluding hydrogen, 84.89%. Such facts again find an obvious explanation in the kinetic hypothesis.

The more important general relationships concerning the abundance of the various chemical elements therefore indicate that the alpha particle plays an important role in the act of atomic synthesis, and that kinetic factors hinder the formation of the heavier atoms.

#### Missing Atomic Species

The atoms of protonic numbers five and eight are unknown. Harkins' rules for nuclear stability show that the species  $Z^5$  should be either rare or else unknown. The missing species  $Z^8$  can only be assigned the formulae  $Gl^8$ ,

which places it in the same class as all the abundant light elements. It is therefore interesting to note that this atom cannot be formed by the union of two helium particles. This is best shown by consideration of the original data of Aston. Table III gives the mass defect for several of the nearby atomic species.

Atom	Mass defect, or the deviation from a whole number (multiplied by $10^4$ )	Possible error in value of mass defect
He	21.6	$\pm 4$
Li <sup>6</sup>	120	$\pm 18$
Li <sup>7</sup>	120	$\pm 18$
B <sup>10</sup>	135	$\pm 15$
B <sup>11</sup>	110	$\pm 17$

For the hypothetical species the mass defect would appear to lie close to 125. The reaction  $2 \text{He} = \text{Gl}^8$  therefore calls for a value of  $\Delta m$  equal to  $125 - 2 \times 21.6$  or 82, and the reaction is a thermodynamic impossibility.

### III. Penetrating Radiation

The existence of penetrating radiation of higher frequency than the hardest gamma rays was first discovered<sup>1</sup> in 1903. These rays enter the earth's atmosphere with equal or very nearly equal intensity in all directions. The intensity shows little variation with time, and depends primarily on the amount of absorbing material through which the rays have passed. The site of origin<sup>2</sup> appears to be the depths of interstellar space.

Of the many measurements on the radiation those of Millikan, Cameron, and Bowers are not only the most extensive but also appear to possess a higher accuracy. These measurements will therefore be used as the basis of all further discussion. The rays have been resolved into three bands for which the mass absorption coefficients are 0.35, 0.08, and 0.04 meters of water. By the use of Dirac's equation (based on the new quantum mechanics) it is possible to calculate the wave length corresponding to any given absorption coefficient. The quantum relation,  $E = h\nu$ , can then be used to determine the change in energy which produced the radiation.<sup>3</sup> The most plausible hypothesis for the formation of the rays ascribes them to the formation of heavier atoms from hydrogen. The change in frequency accompanying an atomic synthesis is assumed to appear as light energy according to the fundamental quantum relation. The necessary transformations are the syntheses of He, O, Si, and Fe by the union of the requisite number of protons. The different bands are not due solely to these changes but include other reactions which release approximately the same amounts of energy. (See Table IV)

<sup>1</sup> McLennan and Burton: *Phys. Rev.*, (2) 16, 184; Rutherford and Cook: 183 (1903).

<sup>2</sup> Millikan and Cameron: *Phys. Rev.*, (2) 31, 169 (1928). For evidence of slight directional effects see Kohlhorster: *Sitzungsber. preuss. Akad.*, 34, 169 (1923); Büttner: *Z. Geophysik*, 21, 87, 291 (1926); Corin: *Z. Physik*, 50, 808 (1928).

<sup>3</sup> P. Dirac: *Proc. Roy. Soc.*, 111A, 423 (1916).

The creation of heavier atoms from hydrogen is supposed to be favored by the conditions of low temperature and low pressure existing in interstellar space. It is supposed that the union of large numbers of particles may take place through the *clustering* of several hydrogen particles into larger aggregates which release the energy of union in a single quantum jump. The above hypothesis of the origin of the rays accounts satisfactorily for the shape of the ionization-depth-curve. The interpretation of the cosmic rays on the hydrogen system is given in Table IV.

TABLE IV

Summary of the Millikan, Cameron hypothesis of the Cosmic Radiation.

Reaction	$\Delta m$	absorption coefficient		Remarks
		calculated	observed	
$4\text{He} = \text{He}$	-290	0.30	0.35	Abundant and determines the character of the band.
$4\text{He} = \text{O}$	-86			A possible reaction.
$7\text{He} = \text{Si}$	-290			A possible reaction.
$2\text{Si} = \text{Fe}$	-168			Not shown by balloon tests.
$4\text{N} = \text{Fe}$	-560			Not shown by balloon tests.
$16\text{H} = \text{O}$	-1245	0.074	0.08	Abundant and determines the nature of the band.
$14\text{H} = \text{N}$	-1080	0.086		Abundant and determines the nature of the band.
$12\text{H} = \text{C}$	-933			Would merely broaden band on long wave side.
$14\text{He} = \text{Fe}$	-750			If present would appear as a small addition to the carbon band.
$28\text{H} = \text{Si}$	-2320	0.041	0.04	Al, Si, and Mg formed by hydrogen reactions would appear in this band. Ca, and K formed in the same manner would broaden the band on the short wave side.
$56\text{H} = \text{Fe}$	-4800	0.019	—	Not detected by experiments, but assumptions of the existence of this band improves the fit of the calculated ionization-depth curve.

#### Some Fundamental Objections to the Hydrogen System

It is claimed that the penetrating radiation consists of high-speed corpuscles.<sup>1</sup> This conclusion, if accepted, does not necessarily dispose of the

<sup>1</sup> W. Bothe and W. Kohlhorster: *Nature*, 123, 638 (1929).

Millikan-Cameron hypothesis, for this hypothesis deals with the energy changes involved in the creation of the rays, and not with the manner in which the released energy makes its appearance.

A more important and fundamental objection lies in the use of the Dirac scattering formula. Data on the scattering of gamma rays are in better agreement with the equation of Klein and Nishina.<sup>1</sup> This equation requires that a given absorption coefficient, ( $\mu$ ), be associated with a larger change in energy than is calculated by the Dirac formula. As an example a value of  $\mu$  equal to 0.04 meters of water is due to an energy change of  $920 \times 10^6$  electron-volts, or very nearly the energy released in the annihilation of a proton. For the Dirac formula the same value of  $\mu$  corresponds to only  $214 \times 10^6$  electron-volts. The Millikan-Cameron hypothesis would be eliminated if the new equation is accepted. The validity of the Klein-Nishina equation in the gamma ray region does not mean that it necessarily applies to the much harder cosmic rays. With radiation of such high frequency the nucleus may take part in the scattering. There are indications of such an effect even in the X-ray region.<sup>2</sup> If the nuclear electrons are effective in scattering then the Klein-Nishina equation would for the cosmic rays approach towards that of Dirac. The Dirac equation will therefore be used, because its use permits an interpretation of the cosmic rays consistent with the evidence from other sources.

#### Other Objections to a Hydrogen System

It will be noted that the iron band was not experimentally detected. It is reasonable however to assume its existence. Such an assumption results in a better fit between the calculated and observed ionization-depth curve. The helium band is softer than the calculated value. The calculated absorption coefficient is 0.30, while the observed is 0.35. On the hydrogen system there are no apparent reactions to furnish the soft radiations necessary to account for this difference. The formation of oxygen by a helium reaction was suggested as a possibility. A minor objection is that through a mathematical error the relative number of quanta in the O, Si, and Fe bands are not in the ratio of 55::26::7, (the ratio of the relative abundance of these atoms) but are in the ratio of 55::37.4::16.4 (see following section).

#### The Cosmic Rays and the Kinetic Hypothesis

The explanation of the cosmic rays given by the kinetic hypothesis is based directly on the fundamental postulates of this system, and avoids the objections raised against the hydrogen system. Because of the assumed excessive abundance of hydrogen, the new interpretation is in its essentials the same as that of Millikan and Cameron.

#### The Helium Band

On the kinetic hypothesis this band is due to the formation of several of the lighter and more abundant elements. The reactions are tabulated in Table V.

<sup>1</sup> O. Klein and Y. Nishina: *Nature*, 122, 398 (1928); Gray: *Proc. Roy. Soc.*, 122A, 647 (1929).

<sup>2</sup> B. Davis and H. Purks: *Phys. Rev.*, (2) 34, 1 (1929).

TABLE V

Reaction	$\Delta m$	Reaction	$\Delta m$
$4 \text{ H} = \text{He}$	-290	$6 \text{ He} + n \text{ He} = \text{Mg}$	-(200 to 290)
		$n = 0, 1, 2$	
$3 \text{ He} + 2 \text{ H} = \text{N}$	-141	$7 \text{ He} + n \text{ H} = \text{Si}$	-(285 to 315)
		$n = 0, 1$	
$4 \text{ He} = \text{O}$	-86		

The abundance of helium radiation determines the character of the band, and leads to essentially the same explanation as given by the hydrogen system. The chief difference consists in the greater prominence assigned to the reaction

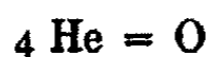

This reaction is necessarily a common transformation, and the softer radiation thus produced is largely responsible for the difference between the observed and calculated absorption coefficients. The effect of the nitrogen rays is that of softening the harder helium rays. Rays due to  $\text{Mg}^{26}$  would slightly soften the band, while the other isotopes of Mg and Si give radiation nearly identical with that of the helium rays.

#### The Oxygen Band

Mixed reactions yielding the necessary decrease in mass are the formation of atoms lying between Zn and Pb. ( $\Delta m = -900$  to  $-1200$ ). There is no evidence to indicate more than a low abundance for these elements. The sum total of their radiations would be outweighed by the formation of  $\text{Fe}^{56}$  with  $\Delta m$  equal to  $-750$ , and the composite band would be softer than that observed. The number of particles involved in the above mentioned mixed reactions range from sixteen to twenty two. The assumption that hydrogen is by far the most common element leads to the expectation that the union of fourteen to sixteen hydrogen nuclei will be far more common than the union of sixteen to twenty two helium nuclei. The new interpretation therefore ascribes this band chiefly to the reactions

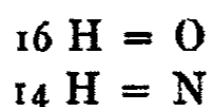

In addition mixed reactions such as



will make a portion of the band.

#### The Silicon Band

These rays are explained in nearly the same manner as on the hydrogen system. The most important reaction is



The formation of Al, and Mg by hydrogen reactions yield radiation of nearly the same hardness. The kinetic hypothesis also ascribes a portion of the band to mixed reactions such as

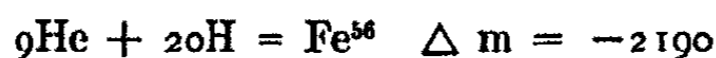

### The Iron Band

This band for which  $\Delta m$  is  $-4800$  (hydrogen system) was not experimentally detected. On the hydrogen system it seems reasonable to assume its existence, and such an assumption results in a better fit between the calculated and observed ionization-depth curve. On the new system no rays harder than  $\Delta m$  equal to about  $-1800$  can be produced by a helium reaction. The formation of  $\text{Ra}^{226}$  by a mixed reaction requires the combination of at least fifty-six particles. Because of the unfavorable kinetics, radium is an exceedingly rare element. Its atoms constitute less than a  $10^{-13}$  part of the total atoms in the earth's crust, and are probably less abundant in the atmosphere. The kinetic hypothesis requires that the reaction

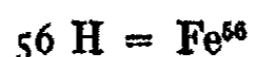

should also occur, and that iron formed as above should be more abundant than radium. But even the assumption that the union of fifty six hydrogen units is many times more probable than the union of the same number of helium particles does not indicate the formation of enough iron atoms to produce more than a weak radiation. On the new interpretation this band is not of sufficient strength to be detected. The proposed interpretation of the cosmic rays is summarized in Table VI.

The kinetic hypothesis should be capable of producing a satisfactory ionization-depth curve. In the hydrogen system the iron band makes an important contribution to the total ionization. At 12 meters it produces 10% of the ionization, while at 70 meters this portion has increased to 53%. Since the kinetic hypothesis eliminates the iron band it must demonstrate that the ionization can be calculated using only the He, O, and Si bands.

### Analysis of the Penetrating Radiation

A theoretical ionization-depth curve would be founded on the following considerations.

- a) A complete spectrum of the cosmic rays, together with the initial intensity of each ray.
- b) The absorption in the atmosphere surrounding a spherical earth. Both the density and composition of the absorbing medium are point functions of the distance above sea level. The ionization at any point is caused by rays coming from all possible directions, and traversing widely varying distances through the atmosphere.
- c) The effect of secondary, tertiary, and softer radiations due to Compton scattering. These rays make all possible directions with reference to the primary beam.
- d) Softer radiation caused by the Compton electrons.

TABLE VI

## Interpretation of the Cosmic Rays on the Kinetic Hypothesis.

Reaction	$\Delta m$	Absorption calculated	Coefficient observed	Remarks
$4\text{H} = \text{He}$	-290	greater than	0.35	Determines nature of band.
$3\text{He} = 2\text{H} = \text{N}$	-141	0.30		Softens the band and increases the absorption coefficient.
$4\text{He} = \text{O}$	-86			Softens the band and increases the absorption coefficient.
$6\text{He} = \text{Mg}^{24}$	-200			Causes a slight softening
$7\text{He} = \text{Si}^{28}$	-285			Not distinguishable from helium radiation.
$16\text{H} = \text{O}$	-1245	0.086	0.08	Determines character of band.
$14\text{H} = \text{N}$	-1080	0.074		Determines character of band.
$12\text{H} = \text{C}$	-750			Would broaden band on long wave side.
$14\text{He} = \text{Fe}^{56}$	-750			Same as for carbon.
formation of metals between Zn and As by mixed reactions	-(900 to 1200)			These rays make up a portion of the band.
$3\text{He} + 11\text{H} = \text{Na}^{23}$	-1180			The band contains mixed reactions of this type.
$28\text{H} = \text{Si}^{28}$	-2320	0.041	0.04	This reaction with formation of Al, and Mg by hydrogen reactions determine the nature of the band. Ca, and K formed in same manner may broaden band on short wave side.
$9\text{He} + 20\text{H} = \text{Fe}^{56}$	-2190			The band includes mixed reactions of this type.
$56\text{H} = \text{Fe}^{56}$	-4800	0.019	not observed	Too weak to be detected.

e) Experimental limitations on the mathematical analysis; as in the case of underwater measurements in lakes of finite area surrounded by mountains, the effect of electroscopes design, etc.

Experimental facts permit a simplification of the analysis. The radiation<sup>1</sup> can be regarded as entering the atmosphere with equal intensity in all directions. For penetrating rays approximately half of the original energy of the quantum will appear as kinetic energy of the electron, and the scattered quantum will have a frequency  $h\nu/2$ . Both the scattered quantum and the electron will move in nearly the same direction as the original beam. An analysis based on these approximations has been carried out by Gray.<sup>2</sup> It was found that the total ionization produced by a homogeneous band of absorption coefficient comes close to an exponential law.

$$I = I_0 e^{-\mu h}$$

The total ionization includes that due to the primary beam, together with all the ions produced by the various degraded quanta. This equation is valid for both the scattering equations of Compton and Dirac.

#### Construction of an Ionization-Depth Curve

Using an exponential equation with values of  $I_0$  for the He, O, and Si bands of 151.2, 10.79, and 1.79 respectively the ionization was calculated at different depths. The calculated values are shown in Table VII.

TABLE VII

Height in equivalent meters of water	Cosmic Ray Ionization as calculated by the Kinetic Hypothesis			Total calculated	Observed ionization	% difference $100 \times \frac{(\text{obs.} - \text{cal.})}{\text{cal.}}$	
	He band	O band	Si band			Kinetic hypothesis	Hydrogen system
70	0.00	0.040	0.115	0.155	0.16	3%	-55%
60	0.00	0.088	0.171	0.26	0.24	8	-50
50	0.00	0.20	0.26	0.46	0.44	-5	-34
40	0.00	0.44	0.38	0.82	0.85	4	-15
30	0.02	0.98	0.57	1.57	1.79	12	0.0
20	0.38	2.18	0.85	3.41	3.95	15	3
15	1.68	3.24	1.04	5.96	6.24	4	3
12	4.13	4.13	1.17	9.43	8.60	-10	-3
10	7.54	4.85	1.27	13.66	12.20	-12	0.0
9	10.15	5.25	1.32	16.72	16.05	-4	7
7	18.53	6.16	1.42	26.1	30.7	15	23
5	33.73	7.23	1.55	42.5	61.0	30	31
3	61.53	8.49	1.68	71.7	127.5	44	35
2	83.00	9.19	1.74	92.9	192.0	52	34

<sup>1</sup> R. A. Millikan and G. H. Cameron: Phys. Rev., (2) 28, 860 (1926).

<sup>2</sup> Gray: Proc. Roy. Soc., 122A, 647 (1929).



Between nine and forty meters both systems show equally good agreement with the observed values. Below forty meters the new system is closer to the observed ionization. At heights above seven meters all calculated values are lower than the observed. On the kinetic hypothesis this is a necessary consequence of the presence of softer radiation, due chiefly to the formation of the relatively abundant oxygen from helium. Millikan seems inclined to the opinion that the differences are due to experimental errors in the measurements at higher altitudes. These errors are estimated as high as possibly 30%, although he also states that the formation of oxygen by a helium reaction may account for the high ionizations. The kinetic hypothesis on the other hand definitely states that this reaction takes place, that it is a common transformation, and that high values are therefore to be expected in the upper portions of the atmosphere. Part of the excess ionization is however caused by the approximation used in the mathematical treatment. The assumption that the scattered quanta travel in the same direction as the original beam reduces to a certain extent the calculated ionization in the higher regions of the atmosphere.

A comparison of the relative number of quanta in each band gives values that accord well with the kinetic hypothesis. The calculations are as follows. The primary ionization according to either the Gray or the Gold formula can be represented by the equation

$$I = I_0 F(\mu h).$$

The total number of ions formed per second in a volume of unit cross section, and of infinite length is

$$\begin{aligned} I^* &= I_0 \int_0^{\infty} F(\mu h) dh \\ &= I_0/\mu \int_0^{\infty} F(\mu h) d(\mu h) \\ I^* &= \text{constant} \times I_0/\mu \end{aligned}$$

It is obvious that the values of  $I^*$  or of  $I_0/\mu$  will to a very high approximation be proportional to the relative number of quanta formed in each band, or expressed in another manner, proportional to the abundance of the atoms in

TABLE VIII  
Relative Number of Atoms formed in each Band

Band	Value of $I_0$ on		Value of $I_0/\mu$ on		Relative number of atoms in each band	
	Hydrogen* system	Kinetic hypothesis	Hydrogen system	Kinetic hypothesis	Hydrogen system	Kinetic hypothesis
He	372	151.2	1240	504	100	100
O	22.2	10.79	277.5	134	22.4	26.8
Si	7.65	1.89	189.5	47	15.2	9.4
Fe	1.65	—	82.5	—	6.65	—

\* Calculated from the Gold tables, see Millikan and Cameron: Phys. Rev., (2) 32, 533 (1928).

the different bands. This follows from the fact that in the absorption of the primary band one ion is formed for each quantum originally present. The upper limit of integration, infinity, means no more than a few hundred meters. The curvature of the earth can therefore be neglected. The calculated number of quanta in the various bands are given in Table VIII:

The calculations of hydrogen system are supposedly based on the assumption that the number of atoms in the O, Si, and Fe bands are in the ratio of 55:26:1.8, or proportional to the relative abundance of these three types of atoms. If the calculations had been correct the numbers in the next to the last column, under the heading hydrogen system, would have been 100, 22.4, 10.6, and 2.86. The calculated ionization-depth curve of the hydrogen system is therefore based on a larger abundance of silicon as compared to oxygen, and a larger abundance of iron relative to oxygen, than is found for the earth's surface. It will be observed that the new system gives a relative abundance of atoms in the silicon and oxygen bands that is about the same as the known abundance of these elements. This is not however a necessary consequence of the kinetic hypothesis.

#### The Effect of the Softer Radiations

The difference between the observed and calculated absorption coefficients of the helium band was ascribed to the presence of softer rays. An estimate of the effect of the soft oxygen radiation can now be made. It is reasonable to assume that about 50% of the total helium formed will appear as oxygen, or that for every 100 helium atoms there are formed at the same time, say 48/4 or 12 oxygen atoms. Using as before the Dirac and Gray equations, the value of  $I_0/\mu$  for the soft oxygen rays is 60.5. This radiation produces at nine and two meters ionizations of 0.03 and 9.70 ions. With an exponential equation, the absorption coefficient between nine and two meters (the same points as used by Millikan and Cameron) increases to 0.315. The explanation given by the kinetic hypothesis is therefore capable of explaining a large portion of the difference between the observed and calculated absorption coefficient.

Because of the assumed abundance of hydrogen, the new explanation of the cosmic rays is in essentials the same as that of the hydrogen system. The differences which do exist are important. They can be summarized as follows:

- a) The helium band is now ascribed partly to the formation of certain of the lighter and more abundant elements. Because of this the absorption coefficient is greater than the calculated value.
- b) The oxygen band is due in some part to the formation of elements lying between Zn and As. Another part of the band is ascribed to mixed reactions.
- c) A portion of the silicon band is due to mixed reactions.
- d) The iron band is present in either very low, or else zero intensity.

Two of these differences are capable of experimental tests, namely; the conclusion that a large amount of soft oxygen radiation exists in the upper reaches of the atmosphere, and the conclusion that radiation more penetrating than the silicon band has very low or else zero intensity.

#### IV. An Hypothesis of the Mechanism of Atomic Formation

It is proposed to demonstrate that by means of a single hypothesis concerning the mechanism of atomic formation it is possible to explain several of the most important facts concerning the chemical elements. It will be assumed that the union of electrically charged nuclei results because of magnetic-like forces acting at right angles to the direction of motion of the particles. Classical electrical theory states that such a force exists between two moving charged particles, and that it is proportional to the product of the speeds of the particles, and inversely proportional to the distance apart. There may be additional attractive forces arising from nuclear spins or from polarization effects. Present interpretations of the wave mechanics also permit the possibility of the union of the particles even when the attractive forces are not sufficient to overcome the potential barrier created by the classical electrostatic repulsive forces. The problem of interest in connection with this hypothesis is not however that of the union of two nuclei, but rather that of the union of several charged nuclei when under the influence of such forces. It will be assumed that between several moving charged nuclei there exist magnetic like forces acting at right angles to the direction of motion, and that such forces increase with increase in the velocity of the moving nuclei, and at high velocities are capable of causing the union of a large number of nuclei.

Atomic formation would on this hypothesis be possible only in a region of long mean free path, or of very low density. The only possible site for the process of atomic creation, and for the origin of the cosmic rays would therefore be the depths of interstellar space. This agrees with the accepted conclusions regarding the origin of these rays. On such a magnetic hypothesis the most favorable conditions for the collision of two or more nuclei consists in their having the same velocity and same initial direction. Now the distribution of kinetic energy among a system of particles must be such that in general only atoms of the same mass will have equal velocities. The most common reactions would then be the combination of particles having the same mass, which justifies one of the basic postulates of the kinetic hypothesis, namely; the assumption that the most probable type of reaction would involve nuclei of one kind only.

The kinetics of this hypothesis require a rapid decline in the probability of the formation of the heavier atoms. This agrees with the known facts of atomic abundance. For collisions involving larger numbers of particles there should be a greater chance of the accidental inclusion of a foreign nucleus, so that in the formation of the heavier elements mixed reactions become relatively more probable. This conclusion is supported by the fact that there are no abundant atoms of this type having an atomic weight less than twenty-

three. The same reasoning indicates that the heavier atoms will have much less tendency to concentrate in the  $4K$  type. This can be illustrated by considering those elements which contain both a  $4K$ , and a  $4K + N$  type of isotope. The only lighter atoms containing the two types are Ne, Mg, Si, A, and Fe. In every case the most abundant isotope has an atomic weight divisible by four. Of the remaining heavier elements listed in Aston's latest tables<sup>1</sup> as containing both kinds of isotopes, the most abundant isotope in six cases out of thirteen falls into the  $4K + N$  type. The magnetic hypothesis therefore gives an explanation for the failure of the heavier elements to display the same regularities as observed for the lighter atoms.

The previous discussion did not take into account the electronic constitution of the nucleus. The accepted theories of atomic structure call for the presence of nuclear electrons equal in number to at least one half that of the number of protons. The charged nuclei which are formed according to the magnetic hypothesis will act as centers of attraction for any electrons which are present. Depending upon conditions a given nucleus will capture electrons as either planetary or nuclear electrons. For the heavier nuclei with their larger charges there should be a greater probability of the capture of nuclear electrons. Isobars should therefore be more abundant for the heavier elements. The same statement obviously applies to isotopes. Both conclusions are supported by Aston's experimental facts. The lightest known isobaric atoms are  $Ca^{40}$  and  $A^{40}$ , while at least seven such pairs are found in atoms heavier than zinc. No element lighter than Mg has more than two isotopes. No atom lighter than Zn has more than three isotopes. At least six of the elements above Zn have from five to nine isotopes.

It is of interest to note that this last argument can be dissociated entirely from the magnetic hypothesis. In which case the same reasoning indicates that the known facts of isotopic constitution can be qualitatively explained on the assumption that electrons are captured by pre-existing atomic nuclei.

### Conclusions

Calculations based on the early theory of relativity, and on new atomic weight determinations show that the calculated mass decreases in radioactive transformations are of the proper magnitudes to account for the energy changes. Aston's new method is sufficiently accurate to permit another test of the theory of relativity.

An equation relating mass defect to atomic weight has been found to be a restatement of the condition that the atomic weights are approximately integers on an oxygen basis.

The assumption that atomic formation occurs through the union of helium and hydrogen nuclei indicates:—

- a) An upper limit of about 340 for the atomic weight.
- b) The concentration of matter into the lighter elements.
- c) The concentration of matter into the  $4K$  type of atom.

<sup>1</sup> Aston: Phil. Mag., (2) 49, 1199 (1925).

d) An explanation of the evolution of the radio-active elements which accords with thermodynamic principles.

e) The possibility of slight variations in any one given type of atom. This suggests the existence of a fine structure in individual mass spectra lines.

An explanation of the cosmic rays is developed in terms of a kinetic hypothesis. While essentially the same as that of Millikan and Cameron it differs in requiring the necessary presence of a large amount of soft radiation in the helium band, and the absence of an iron band. An experimental examination of these differences should be possible. A satisfactory ionization-depth curve was constructed for the new interpretation.

A magnetic hypothesis of the mechanism of atomic creation was proposed. This hypothesis explains the following:

- a) The origin of the cosmic rays in interstellar space.
- b) The concentration of the lighter atoms into the 4K type.
- c) The reason for the divergence of the heavier atoms from Harkins' rules.
- d) The known facts concerning the distribution of isotopes and isobars.

## RHYTHMIC EVAPORATION RINGS OF ORANGE II AND FAST RED B

BY EARL C. H. DAVIES, KENNETH TAYLOR, AND E. W. RIBLETT\*

### Introduction

The first study of the peculiar structures obtained when two dissolved substances are allowed to react slowly to form a precipitate was made by Runge<sup>1</sup> in 1865, when he was attempting to add stiffness or rigidity to blotting papers. He conceived the idea of forming precipitates between the fibres of the paper by first saturating the paper with some soluble compound that would later be precipitated by the diffusion of a second soluble compound into the paper. In the course of his investigations he noticed peculiarities in the form and shape of the precipitates, which peculiarities he found to be a function of the rates of diffusion.

Ord,<sup>2</sup> in 1869, accidentally obtained other growth forms when he allowed ammonium oxalate to diffuse into isinglass which was slightly impregnated with calcium chloride. The insoluble calcium oxalate was obtained in some very fantastic forms, quite different from those obtained when the two reacting salts were mixed in solution.

While experimenting with diffusion phenomena, Lupton<sup>3</sup> noticed that in certain cases layers or rings were produced. However, he merely mentioned their occasional occurrence and did not attempt to investigate them.

It remained for Liesegang<sup>4</sup> in 1896, to report his exhaustive investigations of ring formation in gels. He is the first author to give exact data upon these ring structures, and is among the first to point out their significance in explanation of geological diffusion phenomena. His first preparations were made by placing a drop of silver nitrate solution upon a glass plate that had been coated with gelatin impregnated with potassium bichromate. This gave a series of concentric rings consisting of insoluble silver chromate, the rings being spaced at wider intervals apart in proportion as the distance from the center increased.

In 1914, E. Küster<sup>5</sup> reported and described the rhythmic crystallizations obtained when trisodium orthophosphate, cupric sulfate, ferrous sulfate, potassium ferrocyanide, and ammonium sulfate separated from gelatin solutions on drying at ordinary temperatures. This is thought to be the

\* Presented at the Colloid Division of the American Chemical Society at Minneapolis September 1929.

<sup>1</sup> Runge: "Der Bildungstrieb der Stoffe" (1865).

<sup>2</sup> Ord: "The Influence of Colloids on Crystal Formation" (1879).

<sup>3</sup> Lupton: *Nature*, 47, 13 (1892).

<sup>4</sup> Liesegang: "Phot. Archiv," 1896, 321.

<sup>5</sup> E. Küster: *Kolloid-Z.*, 14, 307 (1914).

earliest reference in the literature to rhythmic bands by evaporation. A year later, A. v. Fischer<sup>1</sup> obtained rhythmic agate-like structures by solidifying very thin layers of molten sulfur. In 1922, E. C. H. Davies<sup>2</sup> reported rhythmic bands of dyes upon filter paper, cotton cloth, and unglazed porcelain when dilute solutions of dyes were allowed to evaporate at constant temperature.

Hans Kagi,<sup>3</sup> in 1923, found that methyl  $\alpha$ -benzoacetoacetate was an excellent example of substances which show rhythmic crystallization. The crystallization occurred at the rate of about one centimeter per minute and could be followed in detail under the microscope. The rings varied in width from a fraction of a millimeter to five millimeters, depending upon the amount of solvent remaining with the crystals, the amount of ester per unit of surface, and the rate of evaporation. He also noted that only freshly prepared solutions of the racemic ester in benzene gave satisfactory crystallization forms.

Garner and Randall<sup>4</sup> reported that, when in the form of thin films, myristic, lauric, undecic, and decic acids crystallized in a rhythmic manner, due to the formation of a solid skin which wrinkled, giving a waved surface. They ascribed the formation of the solid skin to differences between the temperatures of solidifications of the material on the liquid-air and liquid-glass surfaces. They attempted to prove orientation by showing whether the rhythmic crystals were isomerides of the natural form. Cooling curves for this purpose gave two enantiotropic modifications.

In a later article, Davies<sup>5</sup> reported formation of evaporation rings by allowing a suitable dye solution to evaporate from a watch glass. He studied some 40 dyes and about 15 other colloidal solutions, but purposely did not give any quantitative data. Over 100 solutions have been tried in this laboratory.

The object of the present study was to ascertain some of the quantitative relationships between the number of evaporation rings and the conditions affecting the surface of the lens, the concentration of solution, the curvature of the container, temperature of evaporation, and surface tension. This investigation comprises more than 100,000 ring counts.

#### Preparation of Materials

The water was prepared by partial condensation from a Barnstead still, the rate of condensation being such that the collected portion of water was hot. Comparison was made of the use of this water with that of the same water after boiling to two-thirds of the original volume; with that of ordinary distilled water; and with tap water. It was found that the hot water obtained from partial condensation from the Barnstead still contained nothing which influenced the number of evaporation rings, and its use was adopted for all subsequent experiments. Frequent tests on the pH of this water gave 6.9-7.0.

<sup>1</sup> Fischer: *Kolloid-Z.*, 16, 109 (1915).

<sup>2</sup> Davies: *J. Am. Chem. Soc.*, 44, 2705 (1922).

<sup>3</sup> Kagi: *Helv. Chim. Act.*, 6, 264; *Kolloid-Z.*, 33, 284 (1923).

<sup>4</sup> Garner and Randall: *J. Chem. Soc.*, 125, 369 (1924).

<sup>5</sup> Davies: *Proc. W. Va. Acad. Science*, (1928).

*Orange II* was made partly in this laboratory and partly in the Eastman Kodak Research Laboratories. That part which was prepared in this laboratory was by the following scheme:

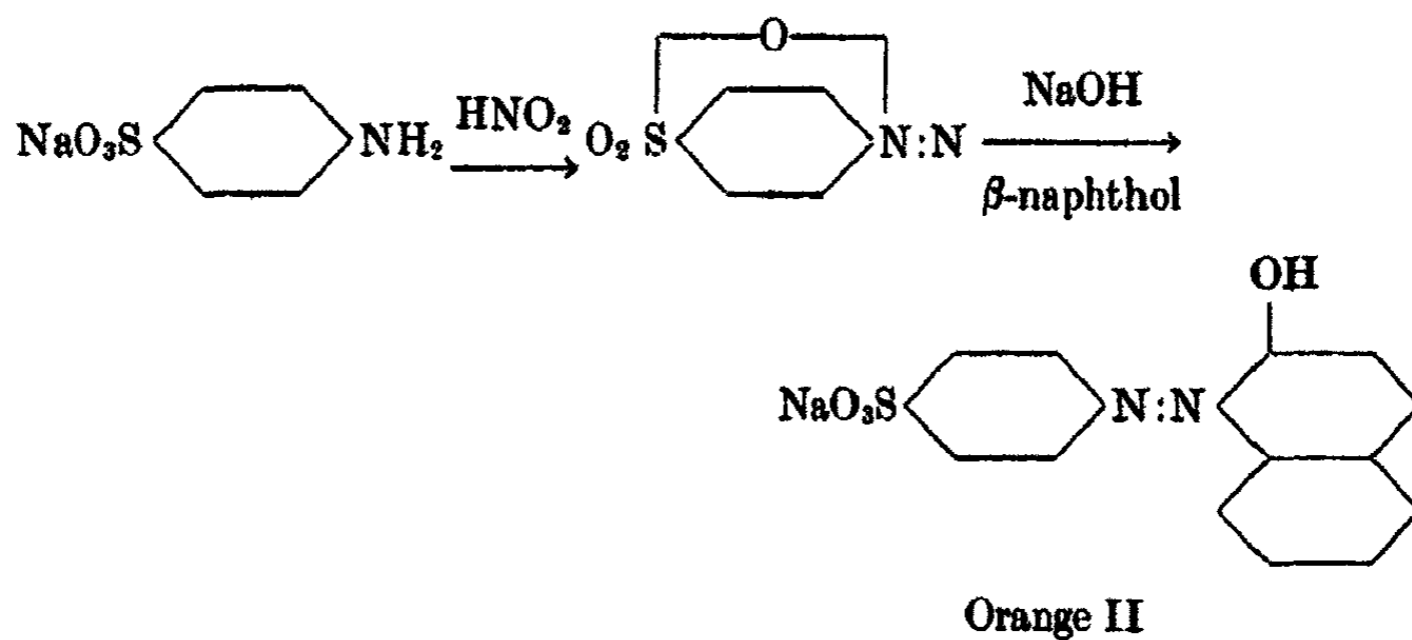

The sulfanilic acid was dissolved in water by careful addition of caustic soda solution. Ice was added until the temperature was about  $5^\circ\text{C}$ . The required amount of hydrochloric acid was poured in and a solution of sodium nitrite added slowly. Tests were made from time to time with starch iodide paper, a slightly blue color indicating that enough sodium nitrite had been added. The  $\beta$ -naphthol was dissolved in sodium hydroxide solution and the solution cooled to about  $15^\circ\text{C}$ . The diazo solution was added slowly with stirring. This was stirred for an hour longer; salt added; and the dye filtered and dried. It was recrystallized three times. To check the purity of the Orange II, a quantity of the purest dye obtainable was secured from Eastman Kodak Research Laboratories. Some of the latter dye was recrystallized, and the product gave results similar to those from the dye made in this laboratory.

*Fast Red B* was made in this laboratory, according to the following scheme:

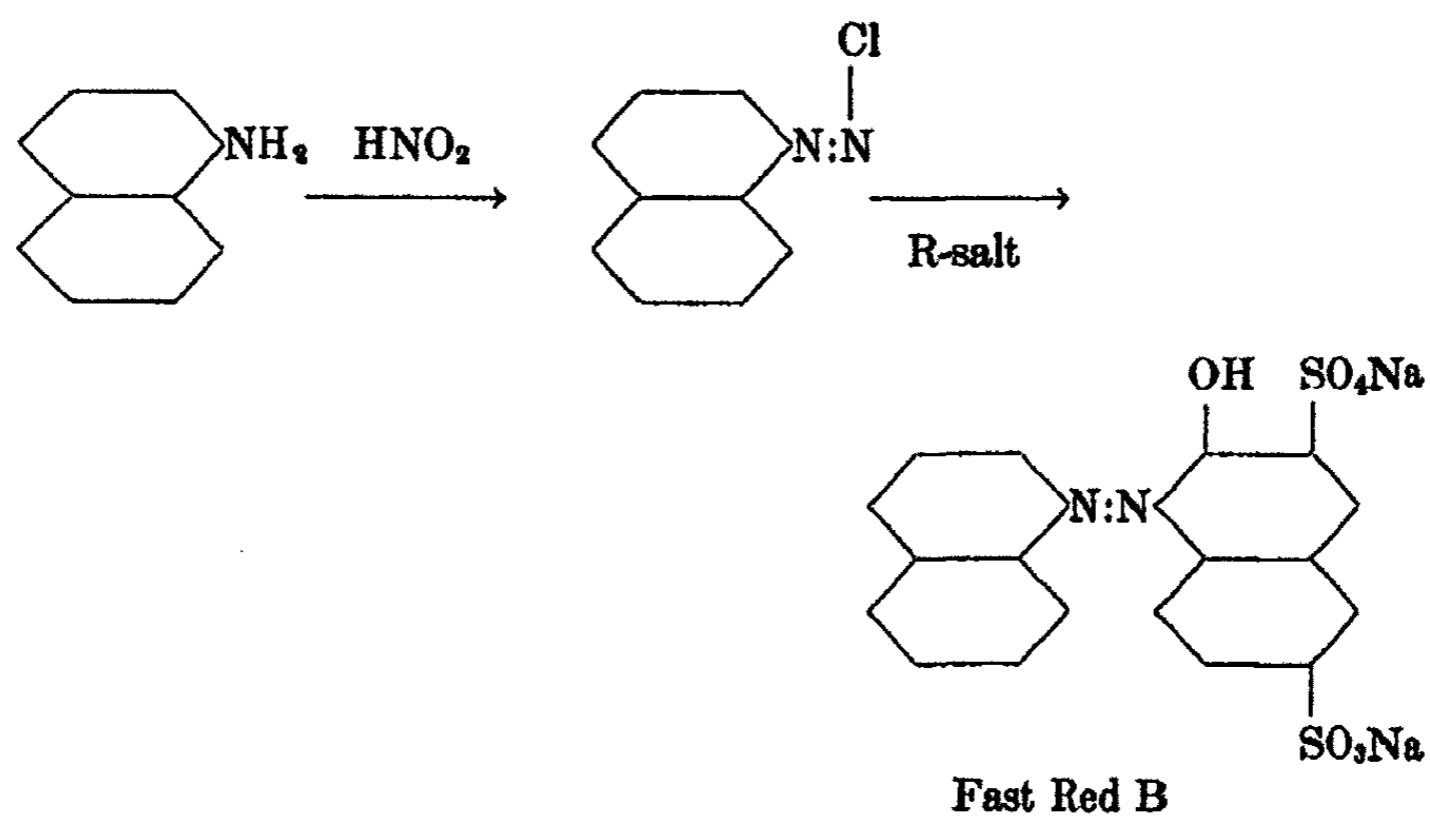



The  $\alpha$ -naphthylamine was dissolved in hot water containing a small amount of hydrochloric acid and the solution cooled to 0°C. The sodium nitrite dissolved in a small amount of water was poured in rather quickly. This diazo solution was then added slowly to the solution of the sodium salt of 2-naphthol-3:6 disulphonic acid (R-salt). The latter solution was prepared by dissolving the calculated amount of R-salt in a large amount of water containing a few grams of sodium hydroxide. The mixture was well stirred during the addition, and for one hour afterward. The solution was heated to 80°C. and a small amount of sodium chloride added to precipitate the dye, which was then filtered off. The dye was redissolved, twice recrystallized, the resultant product dissolved, and the most soluble and least soluble portions rejected. The part retained formed a gel which easily gave up its water, leaving a very fine, brown powder.

*n*-Butyric acid was Eastman Kodak Company's best grade (#60). It was further purified by distilling through a Glinsky tube, the first and last fifths being discarded. The middle portion was redistilled and the first and last fifths again discarded. The portion used boiled at 161.5-163°C. under 730 mm. pressure.

TABLE I  
Radius of Curvature in Millimeters

3½-inch glasses	Spherometer No. 1 l = 40.099 mm.	Spherometer No. 2 l = 48.12 mm.	Average
I	93.24	91.67	92.45
11	93.48	91.99	92.74
12	93.36	92.16	92.76
14	93.45	92.24	92.85
16	93.33	92.36	92.85
17	93.48	92.38	92.93
18	93.24	92.08	92.66
19	93.20	92.05	92.63
24	93.33	92.34	92.83
26	93.55	91.61	92.58
1t	93.20	91.27	92.23
16t	93.03	90.97	92.00
17t	92.58	90.99	91.78
19t	92.80	90.91	91.85
5-inch glasses			
6	156.13	150.59	153.13
7	155.68	150.64	153.16
39	155.77	150.47	153.12
63	155.77	150.53	153.15
1t	163.34	156.57	159.95
6t	160.54	155.99	158.26
7t	162.22	156.25	159.23

*Abietic acid* was Eastman Kodak Company's best grade (#1356) and was used without further purification.

*Ethyl ether* used for dissolving the abietic acid was U.S.P. obtained from the Will Corporation. Part of this was redistilled but gave the same results as the original.

*Watch glasses.* Out of over 1,000 watch glasses examined for curvature, 300 of apparently uniform curvature were tested with spherometers. Results in Table I for the 21 best watch glasses show that even after this amount of work, although uniform among themselves, they were not spherically curved. That is the watch glasses were flatter near the center.

These radii were calculated by substitution in the formula:

$$r = \frac{h}{2} + \frac{l^2}{6h}$$

where  $r$  is the radius of curvature in millimeters,  $h$  is the spherometer reading in millimeters, and  $l$  is the distance between the tripod points of spherometer.

*Optical lenses*, about 4.5 cm. in diameter, were obtained from Bausch and Lomb Optical Co. They were highly polished and ground to uniform curvature. These lenses were of eleven curvatures, the radius of curvature ranging from 24.99 mm. to 115.48 mm. There were three duplicate lenses of each curvature. The curvature was measured with a tripod spherometer, the results of which are shown in Table II.

TABLE II  
Radius of Curvature in Millimeters

Lens number	Radius of curvature
A	115.48
B	81.42
TA	70.16
C	59.48
TB	50.16
D	44.27
TC	40.87
E	35.35
TD	30.75
F	27.59
TE	24.99

#### Experimental

*General Procedure.*—All lenses, pipettes, and containers, were immersed in fresh cold cleaning mixture for at least twelve hours or in hot cleaning mixture for at least three hours. They were then thoroughly rinsed with the special distilled water, and dried in the electric oven at 50°C. The lenses were not touched with the fingers.

Calibrated pipettes were used in adding the dye solution to the lenses and evaporation was carried out in a Freas electric oven at constant temperature.

*Low Force of Adhesion of Orange II and Glass.*—On clean lenses the number of evaporation rings of Orange II were sensitive to slight differences in washing and drying, due to the small force of adhesion between the solid Orange II and the surface of the lenses. This irregularity was clearly shown in a series of preliminary experiments with Orange II. These experiments comprised over 5,000 ring counts on 165 lenses and watch glasses. For the sake of brevity, tables are omitted but the conclusions are as follows.

1. The number of evaporation rings increased with concentration. This is contrary to all results which have been obtained with evaporation rings which adhere well to the surface of the evaporating dish.

2. Orange II solutions gave more rings on flatter than on steeper dishes. This is also contrary to all results obtained with evaporation rings which adhere well to the lens. No rings were obtained with solutions of Orange II when special care was taken to clean the lenses.

3. The force of adhesion between solid Orange II and glass is so slight that a foundation film is essential for a quantitative study of evaporation rings.

*The Foundation Film.*—Whereas solutions of Fast Red B of every degree of purity gave evaporation rings on all surfaces tried, solutions of Orange II gave good rhythmic evaporation rings only under certain definite conditions. For example, when the special optical lenses were carefully cleaned, Orange II gave but one band near the center of the lens. On the other hand, where the lens was carelessly cleaned or rubbed with the hand it gave very good rings.

The difference between the formation of no rings with the pure Orange II on clean lenses and the formation of rhythmic evaporation rings in the presence of impurities might be due to one or more of three factors: 1. The condition of the surface of the lens itself; 2. The presence of a foreign substance in the solution; 3. The presence of a surface film on the dye solution. Each of these was studied.

*Adsorbed Gas.*—Since the gas would be air in the ordinary experiments, and since the amount adsorbed would be greatest when the lens was driest, a comparison was made between the number of evaporation rings produced on duplicate lenses, on one set of which the dye solution was added immediately after washing, whereas the other two sets of lenses were kept over phosphorus pentoxide at 50°C. for as much as two days. This extra drying had no effect on the number of evaporation rings. A film of adsorbed air on the glasses is not responsible for rhythmic evaporation rings of Orange II.

*Adsorbed Liquids.*—The impurity responsible for the rhythmic evaporation rings of Orange II on carelessly cleaned lenses might be a liquid which assisted in sticking the evaporation rings on the glass surface. This liquid could come either from vapors or direct addition, as when the lens is rubbed by the hand, which leaves a thin oily film on the glass. Liquids studied were:

water, methyl, ethyl, n-propyl, n-amyl, and n-octyl alcohols, geraniol, carvacrol, n-butyric acid, n-caproic acid, and stearic acid.

In order to allow the vapors of water and alcohols to condense upon the lenses, 0.1 gram of each liquid was put in an open weighing bottle and enclosed, together with the lenses, in a 250 cc. beaker, and allowed to heat for at least one hour at 50°C. A duplicate set was allowed to heat in a similar way at 150°C. A measured volume of 0.1% Orange II was added to each lens and allowed to evaporate at 50°C. In case of the acids, the exposure of lenses to the vapors was for more than 15 hours at 50°C. Results showed that rhythmic evaporation rings of Orange II were probably not due to vapors adsorbed from the air.

*Adsorbed Solids.*—The impurity responsible for the rhythmic evaporation rings of Orange II on carelessly cleaned lenses might be a solid which assisted in sticking the evaporation rings on the glass surface. Since camphor sublimes at temperatures of 50° and 150°C. lenses exposed to these vapors should, when cooled to ordinary temperatures, be coated with a thin film of solid camphor, but this did not result in formation of rhythmic evaporation rings of Orange II.

Clean dry lenses, covered and uncovered, were exposed to laboratory air for about eighteen hours, and although the deposition of solid dust on the uncovered lenses did not materially influence the formation of evaporation rings on these same lenses, it was thought probable that a closely adhering solid film might affect the number of these rings. Rosin consists of about 94% abietic acid ( $C_{19}H_{28}O_2$ ), whose physical characteristics, including its insolubility in water, are such that it seemed probable that a thin film of abietic acid on the surface of the lenses might assist in causing evaporation rings of Orange II to adhere to the lenses.

The clean dry lenses were dipped into a 0.104% solution of abietic acid in ethyl ether, the excess being allowed to drain off while keeping the lenses nearly vertical just above the surface of the solution. The transparent film of abietic acid in contact with the Orange II was found to weigh about 0.0001 gram.

*Electrical Condition of the Surface of Lens.*—Cataphoresis experiments show that in a solution of Orange II the particles of dye are negatively charged. It is conceivable that the surface of the lens might be charged with negative electricity, resulting from friction or from adsorbed substances, and that this negative charge would operate against the adhesion of negatively charged particles of Orange II on the surface of the lenses. Water on glass gives a negative charge to the glass. When dry glass is rubbed with silk the surface of the glass becomes positive. This would remove the negative charge from the glass and the formation of rings might be facilitated providing the glass retained its positive charge after the dye solution had been added.

Experiments were carried out in which dry lenses were rubbed with clean silk. Good rhythmic evaporation rings of Orange II were then produced. Somewhat similar results were obtained when dry lenses were rubbed with

the fingers, absorbent paper, absorbent cotton, and glass wool. Experiments with lenses of assorted curvatures showed the following increase in number of rings of Orange II resulting from about one minute of vigorous rubbing; fingers 13; silk 11; cotton, 7; absorbent paper 7; glass wool 6. In order to determine if the abrasion of the surface caused the evaporation rings to form, the lenses were cleaned in the usual manner and Orange II solution again evaporated from them. No rings were obtained.

*Effect of Concentration on the Number of Rings.*—In all experiments for which tables on evaporation rings are given, only the Bausch and Lomb optical lenses were used. For Orange II they were coated with the thin transparent film of solid abietic acid. Averages in Table III and Fig. 1 show that the number of evaporation rings of Orange II and Fast Red B are fewer for concentrated than for dilute solutions.

TABLE III  
Concentration Effects

Radius of Curvature	Number of rings from Orange II (3.125 cc. at 50°C.)					
	0.01%	0.10%	0.25%	0.50%	1.00%	5.00%
70.16	26.58	16.06	10.5	7.5	5.16	0
50.16	31.49	18.24	11.6	9.5	6.50	0
40.98	41.83	20.53	11.8	10.0	7.00	0
30.75	44.50	21.38	11.7	11.0	8.17	0
24.99	45.41	23.19	14.0	11.5	9.83	0
Average	31.36	19.88	11.9	9.9	7.32	0

Radius of Curvature	Number of rings from Fast Red B (2.246 cc. at 50°C.)								
	0.0005%	0.005%	0.05%	0.10%	0.20%	0.30%	0.50%	0.75%	1.00%
115.48	33	35	23	19	12	12	7	7	4
81.42	41	40	27	23	17	15	10	8	6
59.48	45	54	29	24	18	15	11	8	6
44.27	47	57	28	24	17	14	11	8	5
35.35	49	61	32	26	19	15	11	8	5
27.59	66	70	34	27	18	15	11	8	5
Average	47	53	29	24	17	14	10	8	5

There are no rings for a saturated solution, the number increasing with dilution, first slowly and then more rapidly. With solutions of Orange II more dilute than 0.01% the rings were blurred, while with Fast Red B evaporation rings were distinct, but discontinuous, even at a dilution of 0.0005%. The number of evaporation rings of Orange II and Fast Red B varies inversely with the concentration of the solution.

*Effect of Curvature on the Number of Rings.*—Table IV summarizes the results of about 70,000 ring counts.

Column 1 gives the radius of curvature. The steepest lens had a radius of curvature of 25 mm. while the flattest had a radius of curvature of 115.5 mm. Column 2 contains the average number of rings obtained for all concentrations of the pure dyes. In column 3 are averages for 0.1% dye solution at different temperatures. Column 4 gives averages for 0.1% Fast Red B containing varying amounts of n-butyric acid. The last column in Table IV gives the mean of all these averages for all concentrations, all temperatures, and in the presence of n-butyric acid.

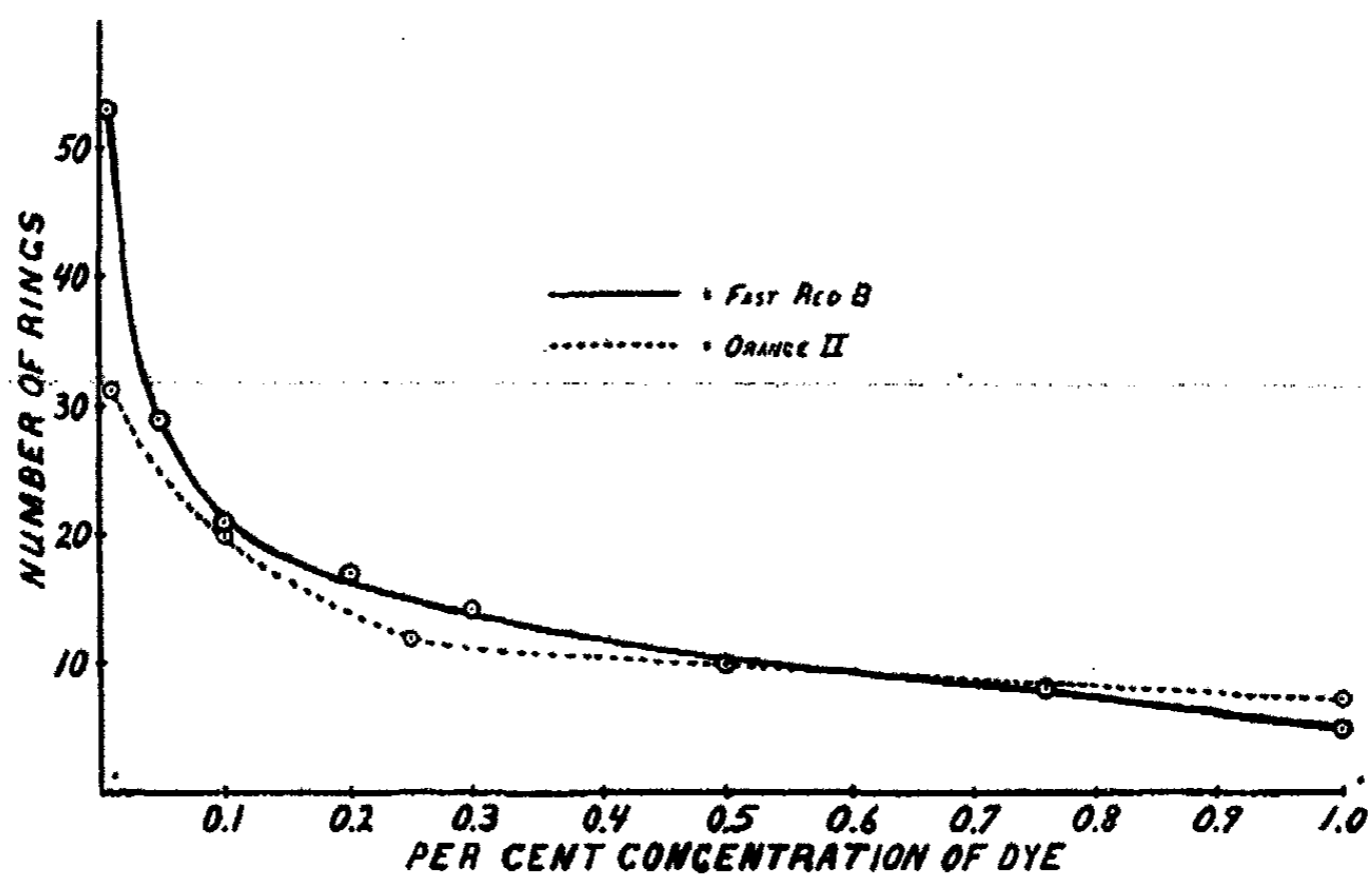

FIG. 1  
Variation in number of rings with concentration.

TABLE IV  
Curvature Effects

Radius of curvature	Concentration series 50°C.	Temperature series	Butyric acid series 50°C.	Grand average
Orange II (3.125 cc.)				
70.16	11.95	16.54		14.24
50.16	14.06	18.76		16.41
40.87	17.34	19.71		18.52
30.75	18.51	20.22		19.37
24.99	19.61	21.25		20.43
Fast Red B (2.246 cc)				
115.48	20	19	30	23
81.42	24	22	35	27
59.48	28	23	37	29
44.27	28	22	41	30
35.35	30	25	42	32
27.59	35	26	43	35

These "grand averages" are plotted in Fig. 2 which also contains curves for 0.1% dyes at 50°C. These curves show that the number of evaporation rings increases as the lenses become more highly curved. All these curves seem to be straight lines.

Some preliminary study has been made of curvatures greater and less than those shown in Fig. 2. Microscope cover-glasses at different angles were put in open weighing bottles containing dye solution. Evaporation was carried out at 50°C. With both Orange II and Fast Red B evaporation rings were obtained on the vertical wall and on the upper surfaces of the slanting side of the glass slides. That this limiting angle for rings is less than that of a

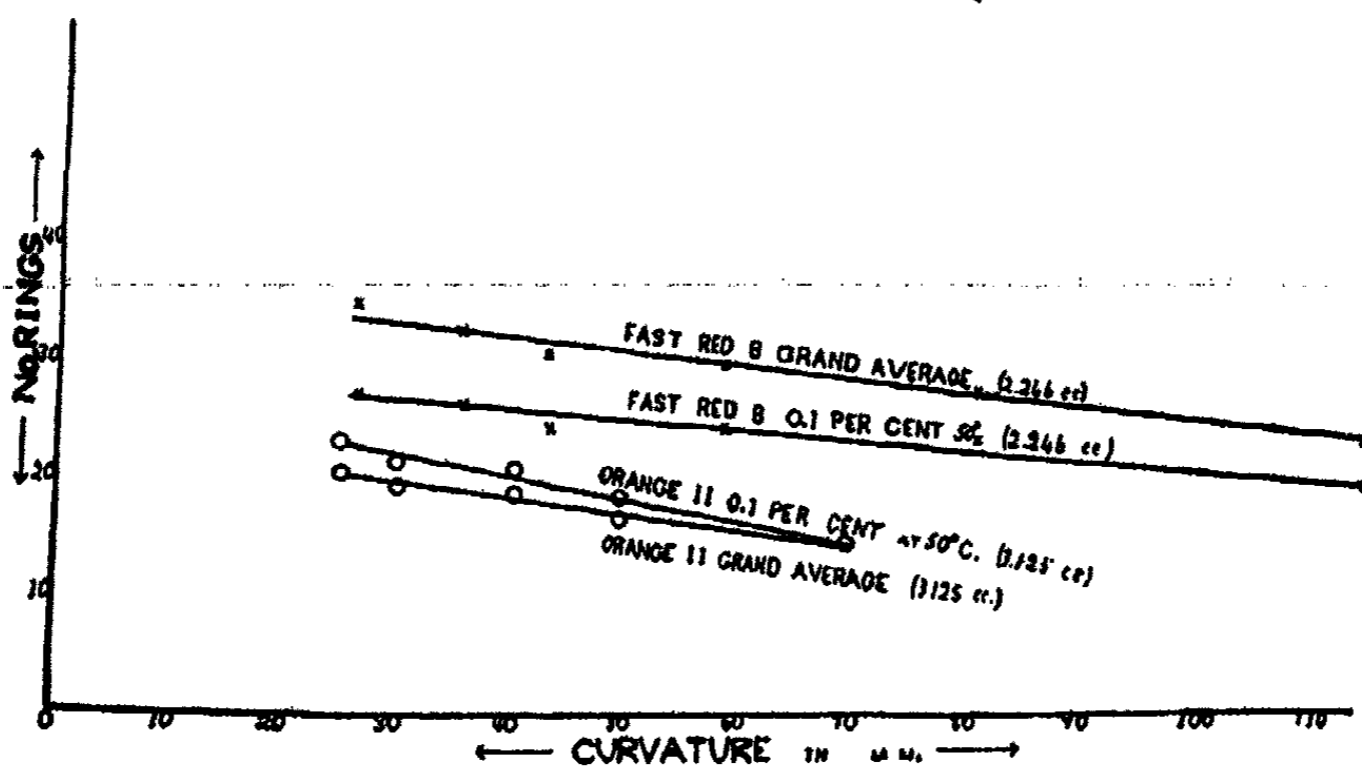

FIG. 2

plane perpendicular to the surface of the dye solution is shown by the fact that rings of Fast Red B were formed on the inside walls of a small Erlenmeyer flask.

A highly interesting experiment was carried out as follows. A 3-inch watch glass with a hole in the center was put, convex side up, inside a crystallizing dish of very nearly the same diameter. A 0.1% solution of Orange II was poured into the dish until the watch glass was just covered. Evaporation at 50°C. left good rhythmic rings on the upper surface but none on the under surface, where the angle of contact was sharp. Gravity would also help to pull the dye away from the under surface.

*Effect of Temperature.*—Using optical lenses coated with a film of abietic acid, 0.1% Orange II solution was evaporated at each of three different temperatures—32, 50, and 85°C. From the average shown in Table V it is seen that the number of evaporation rings of Orange II increases with temperature.

It is possible that at least a part of this large increase in number of rings with temperature may have been due to the action of heat on the film of abietic acid. With 0.1% Fast Red B at the same temperatures there was a slight decrease in the number of evaporation rings for the higher temperatures.

TABLE V  
Temperature Effects

Radius of curvature	Number of rings		85°C.
	32°C.	50°C.	
	Orange II (3.125 cc.)		
70.16	12.33	16.06	21.22
50.16	14.44	18.24	23.61
40.87	14.91	20.53	23.69
30.75	15.36	21.38	24.91
24.99	17.00	23.19	25.56
Average	14.81	19.88	23.80
	Fast Red B (2.246 cc.)		
115.48	20	19	18
81.42	24	23	20
59.48	24	24	21
44.27	23	24	20
35.35	25	26	23
27.59	27	27	24
Average	24	24	21

*Effect of Surface Tension.*—In attempting to explain evaporation rings, one of the first things thought of is what relationship there might be between ring formation and surface tension. Surface tension changes will result from either temperature change, or the addition of almost any impurity to the dye solution. The quantitative relationship between surface tension and the temperature of evaporation of Fast Red B has not yet been worked out, but it has already been shown that the number of rings decreases with a rise in temperature. *n*-Butyric acid lowers the surface tension of Fast Red B from 72.39 dynes for pure 0.1% solution to 58.67 dynes for 0.1% dye solution containing 1% butyric acid. The corresponding numbers of evaporation rings are 24 for the pure dye and 83 for the solution containing butyric acid. That this increase in the number of evaporation rings, produced in the presence of *n*-butyric acid, is not entirely dependent upon surface tension seems apparent from the fact that similar experiments with 0.1% Fast Red B containing the same normalities of hydrochloric acid instead of butyric acid gave decreases in the number of evaporation rings (from 21 for pure dye to 16 for 0.057N HCl and 12 for the 0.085N HCl), although the HCl was found to lower the surface tension of the dye solution. Furthermore, the surface tension of 0.1% Orange II is lowered by *n*-butyric acid while the number of evaporation rings is nearly the same as for pure Orange II.

The behavior of *n*-butyric acid in 0.1% Fast Red B is interesting in that increasing concentrations of *n*-butyric acid caused rapid change in the number of evaporation rings. From 0.02% to 0.6% the increase is slow and linear. Above 0.6% the increase in the number of rings is very much greater. Thus between 0.02% butyric acid and 0.6% butyric acid the number of rings increases from 26 to 29; further change in concentration from 0.6% to 1% butyric acid increases the number of rings from 29 to 83.



TABLE VI  
Effect of Butyric Acid on 0.1% Fast Red B

Per cent butyric acid	0	0.02	0.10	0.30	0.50	0.65	0.75	1.00
Number of wide rings	21	25	27	25	20	19	15	0
Number of fine rings	0	0	0	2	8	15	25	83
Total number of rings	21	25	27	27	28	34	40	83

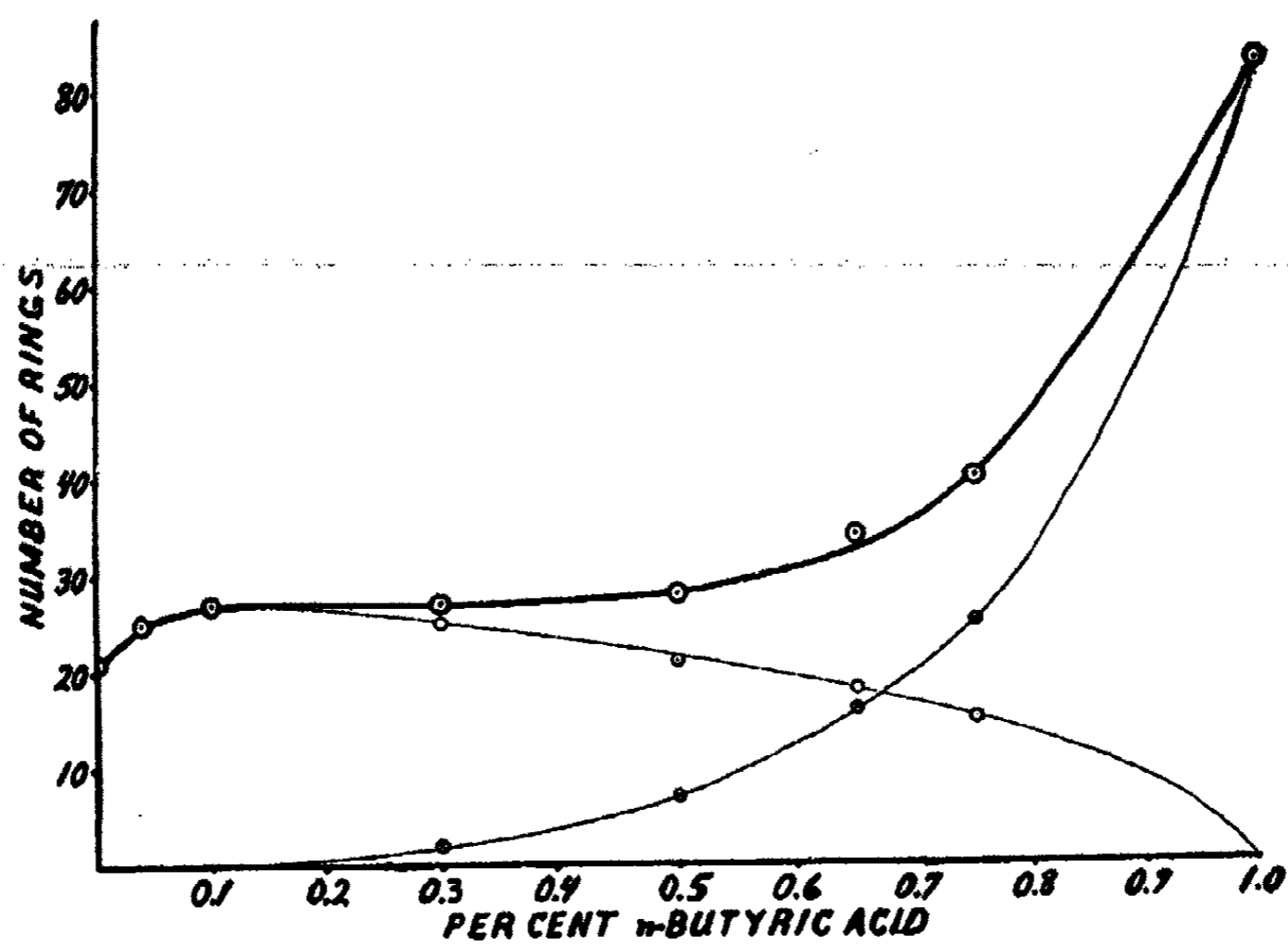

FIG. 3  
Variation in number of rings from 0.1% Fast Red B with concentration of n-butyric acid at 50° C

- Average total number of rings
- ⊗— Average number of very fine rings
- Average number of large rings

Beginning at a concentration of 0.1% n-butyric acid, the number of heavy rings steadily decreased, according to Fig. 3. At the concentration of 0.1% n-butyric acid, there appeared small, very fine rings on the outer portion of the lens, the number and area covered by them increasing with increase in concentration of butyric acid. That is, the number of fine rings increased with concentration of acid, while the number of ordinary sized rings decreased with increase of concentration of acid, until at a concentration of about 1% n-butyric acid, almost the entire surface of the lens was covered with fine rings.

### Summary

Pure Orange II solutions give no rhythmic evaporation rings when the evaporation containers are perfectly clean.

Rhythmic evaporation rings of Orange II are not due to air or vapors adsorbed from the laboratory by the evaporating containers.

A surface skin of a foreign substance may result in formation of rhythmic evaporation rings when the film is not too volatile and is capable of helping to cause the evaporation rings to stick to the surface of the container.

A thin transparent film of abietic acid on the surface of the evaporating container is a satisfactory foundation film for the formation of rhythmic evaporation rings of Orange II.

When such a foundation film of abietic acid is on the surface of the container the number of evaporation rings formed from a given volume of Orange II solution becomes greater (1) as the concentration of the solution decreases, (2) as the temperature of evaporation increases, and (3) as the radius of curvature of the evaporating container decreases.

With Fast Red B no abietic acid or other foundation film is necessary and the number of evaporation rings becomes slightly less at higher temperatures, whereas concentration and curvature effects are similar to those of Orange II.

n-Butyric acid lowers the surface tension of Fast Red B and at the same time causes an increase in the number of evaporation rings.

*Chemistry Department,  
West Virginia University,  
Morgantown, W. Va.,  
August 19, 1929.*

## ACTIVE GLUCOSE\*

BY CHARLES E. CLIFTON AND JOHN M. ORT

In the complex equilibrium of solutions of sugar, there seem to be certain forms of the sugars which, although usually present only in traces, are, nevertheless, reactive. Levene<sup>8</sup> has reviewed the evidence for "active glucose." Additional facts, discovered by oxidation-potential technic, have been reported recently by one of us<sup>12</sup> (Ort). These data can hardly be understood without the assumption of the existence of such an active sugar. Since this technic makes possible the detection of exceedingly slight chemical changes, it appeared possible to determine by it the actual amount of active glucose present. These determinations, carried out with the same apparatus and general procedure as previously published,<sup>11</sup> are herein described.

Solutions were first investigated which had stood for fifteen hours while being constantly stirred by pure nitrogen gas at the rate of two bubbles a second, as in the previous experiments.<sup>12</sup> At this time drifts in reduction potentials were quite slow, indicating that something in the nature of preliminary equilibrium had been established. Much longer standing would seem to risk the appreciable accumulation of the products of secondary and side reactions which go on slowly during exposure of the sugar even to weak alkali. Solutions of glucose in sodium hydroxide-sodium phosphate buffers at pH 10 were used in all experiments. They were made up by adding the designated weight of sugar to 100 c.c. of the appropriate buffer. To get an idea of the order of magnitude of the amount of the active form involved, the following preliminary experiments were done.

A constant amount of oxidant, 0.5 c.c. of a 0.03 percent hydrogen peroxide solution, was added to different amounts of glucose. The drifts of oxidation potentials with time are represented by the curves in Fig. 1. As the amount of sugar increases, three things happen: (1) the reduction potentials acquired, after standing fifteen hours, drop steadily toward a limiting value; (2) the highest or peak oxidation potentials reached after additions of oxidant are also lower; and (3) if the amount of sugar is large enough there may not be a great change in potential following the addition of this amount of oxidant at this rate of stirring.

The first of these facts suggests that, as the concentration of the sugar increases, the concentration of the electromotively active reductant also increases. Since the peak potentials are later replaced by the original reduction potentials, the total glucose present does not exist in a simple oxidation-reduction system in reversible equilibrium with its oxidation products. The

\* Division of Physics and Biophysical Research, The Mayo Foundation, Rochester, Minnesota. The data presented in this paper are taken from a thesis submitted by Charles E. Clifton to the Faculty of the University of Minnesota in partial fulfillment of the requirements for the degree of Ph.D., 1928. Read before the American Chemical Society, Swampscott, Massachusetts, September, 1928.

step from the active reductant to its first oxidation product may be reversible but the system as a whole under these conditions is controlled preponderantly by a force entirely from outside this reversible part. The addition of a small amount of an oxidant to a simple reversible system would be followed by an almost immediate rise in potential to a thermodynamically calculable value where it would remain.

The second and third facts also suggest that there is some quantitative reaction between the amount of sugar present and the oxidant added. This conclusion is also strengthened by the fact that if varying amounts of the peroxide are added to solutions containing 60 gm. of glucose, a similar set

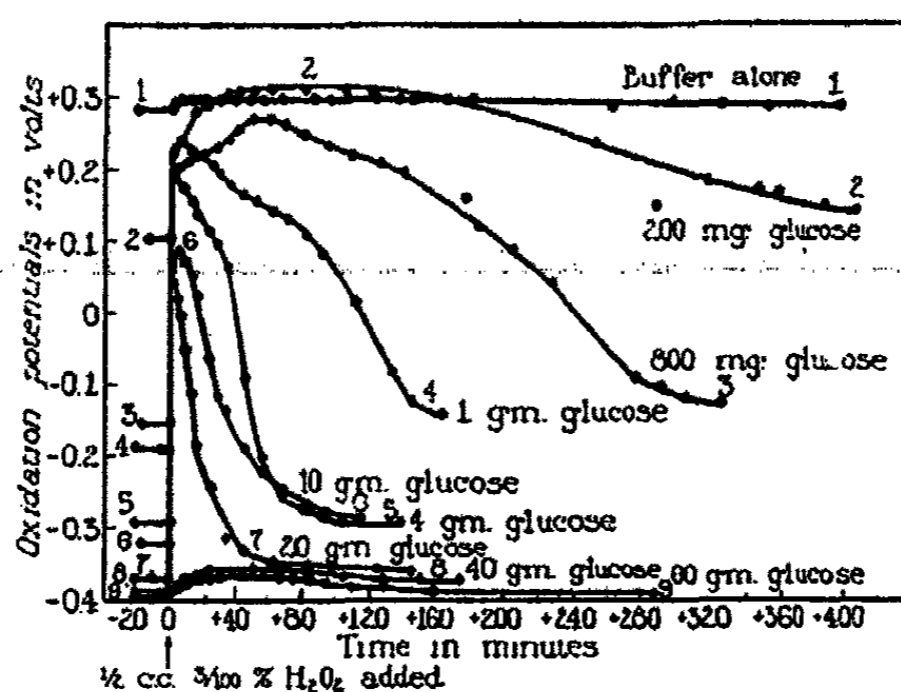

FIG. 1

A constant amount of oxidant added to increasing amounts of glucose.

of curves could be plotted. That is, 0.5 c.c. and 1.0 c.c. of peroxide produced relatively small rises in potentials at this rate of stirring, whereas 2.0 c.c. and 3.0 c.c. brought about much larger ones.

It was evident from these experiments that the amount of active reductant present even in concentrated solutions of glucose is very small. In order to determine it by potentiometric titration an exceedingly dilute standard-oxidizing solution was required. Dilute hydrogen peroxide solutions seemed unsuitable, since part of their total oxidizing capacity is due to dissolved oxygen and part to hydrogen peroxide. It seemed undesirable to titrate with a solution containing two different oxidants, regardless of how similar their reactions might be, especially when one of them, the peroxide must go through intermediate reactions to furnish its active oxidant, and we were titrating a reductant that was being constantly replaced when removed by oxidation.

Fortunately it happens that the solubility of air which is free of carbon dioxide in distilled water under ordinary laboratory conditions is just such as to make the solution 0.001 N with respect to oxygen. Hence 1 c.c. =

0.000001 gm. equivalent of oxidant. Such distilled water was therefore used in the titrations described here.

In this connection it should be noted that when 50 c.c. of boiled distilled water was added to the solutions of sugar, a change in reduction potentials was not observed. Likewise a hydrogen electrode in these solutions remained at a constant potential after such an addition, indicating that this amount of dilution with oxygen free water did not appreciably affect the pH. Hence we conclude that all effects herein reported are due to the dissolved oxygen.

Solutions containing 60 gm. of glucose were selected for titration. When the sugar was dissolved in the buffer the volume was approximately 139 c.c. and the pH was  $10.00 \pm 0.02$ . Because these solutions were more viscous

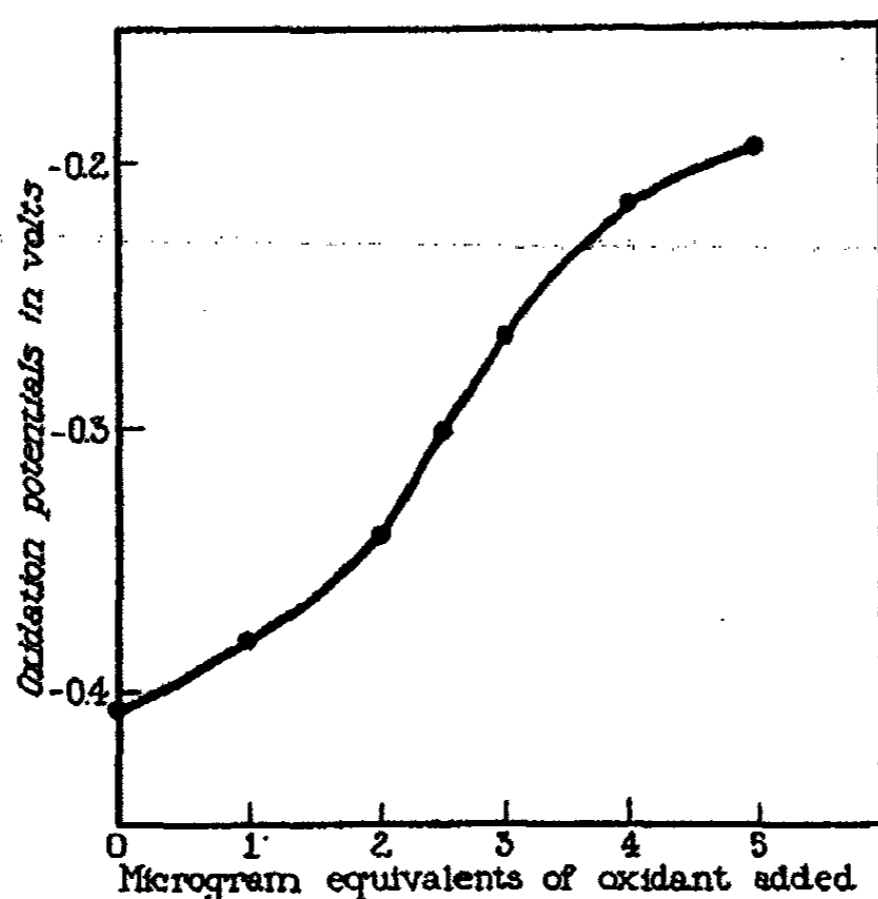

FIG. 2

Potentiometric titration curve of active glucose in 60 gm. of the sugar.

than the dilute solutions hitherto used in these studies, the rate of bubbles of nitrogen gas was changed from two to five bubbles a second during the fifteen hours' standing. Even at this faster rate, it was found that the oxidant was not mixed rapidly enough throughout the entire solution. Therefore, just after an addition, this rate was increased for a quarter of a minute to twenty bubbles a second and then again put back to five bubbles a second. This procedure gave much more constant results than were observed when the rate was left unchanged. Apparently, at the slower rates the oxygen in the distilled water reacted with the sugar on top and recovery could take place before this part of the liquid penetrated the denser and more viscous layer of solution around the electrodes at the bottom of the tubes.

It has been reported for much more dilute solutions,<sup>12</sup> that sudden changes in the rate of bubbles produced sudden changes in the reduction potentials

of those solutions. However, for the 60 gm. solutions, it was observed in control experiments that such a temporary shift did not produce any appreciable change in the potential readings. In the dilute solutions formerly used there could have been hardly more than infinitesimal amounts of the active reductant present. Any sudden change of experimental conditions might be expected to produce noticeable fluctuations in reduction potentials in such solutions. But, whatever the reason, the temporary violent bubbling did not of itself affect the potentials of the 60 gm. solutions. It did give rapid mixing throughout the entire solution and much more constant results, and was therefore used in experiments reported here.

Fig. 2 shows the potentiometric titration curve plotted after a consideration of the results of several hundred experiments. The point of inflection of this curve is at 2.5 c.c., which fixes the amount of the most active reductant at 0.0000025 gm. equivalent.

The potential for zero added oxidant is shown as  $-0.406$  volt. This is the potential acquired by platinum electrodes after they had stood in these solutions for fifteen hours under the conditions described. This value is an average obtained from several hundred experiments of which more than half gave potentials within 5 millivolts of this figure and over 80 percent within 10 millivolts.

This value did not seem to be affected much by the previous treatment of the electrodes, that is, whether they were heated to incandescence just previous to the run, treated with sulfuric and chromic acids or aqua regia, or simply rinsed in distilled water between runs. The behavior of the electrodes after an addition of oxidant was found to be somewhat affected by this previous treatment, although for any series of runs in which this treatment was kept constant, the inflection of the titration curve came always at about 2.5 c.c. The curve shown here is from experiments in which the electrodes were simply rinsed in distilled water between runs.

The potentials for 1 c.c., 2 c.c., and so forth, of added oxidant are the peak voltages reached after the additions of these amounts of aerated, distilled water. In a few moments after reaching these peaks the potentials would begin to drift back toward the  $-0.406$  value which they would reach in several hours. After this recovery, the subsequent addition of an identical amount of oxidant would usually result in a slightly higher peak value and therefore for the curve here shown a new glucose solution was used for each addition. However, if after constant preliminary additions of this order of magnitude and the subsequent recoveries, these 1 c.c., 2 c.c., and so forth additions were made and the somewhat higher peaks resulting were plotted, the inflection of the curve still came near 2.5 c.c.

In this connection it should be noted that these solutions were commonly made up exposed to the laboratory air. Since the stirring and exposure during solution could not be exactly uniform it might be thought that the resultant fifteen-hour voltages or the peaks would be affected. This was found not to be the case for even when compressed air or pure oxygen gas was

bubbled vigorously through the liquid during and after the solution of the sugar, for a total period of ten minutes, the results on standing and titration were not found to be appreciably affected. Certain solutions were prepared by placing the dry glucose in the electrode chamber and removing air from the space above the sugar by flow of nitrogen gas for an hour. The buffer which had been deoxidized by nitrogen was then added from a special pipette, care being taken to exclude air from both buffer and electrode chamber during the addition. Although the immediate electrode potentials of such solutions, measured just after the last bit of solid dissolved, were somewhat more negative than the ones prepared in air, the voltages acquired on standing and titration were practically the same as the usual values. Therefore we con-

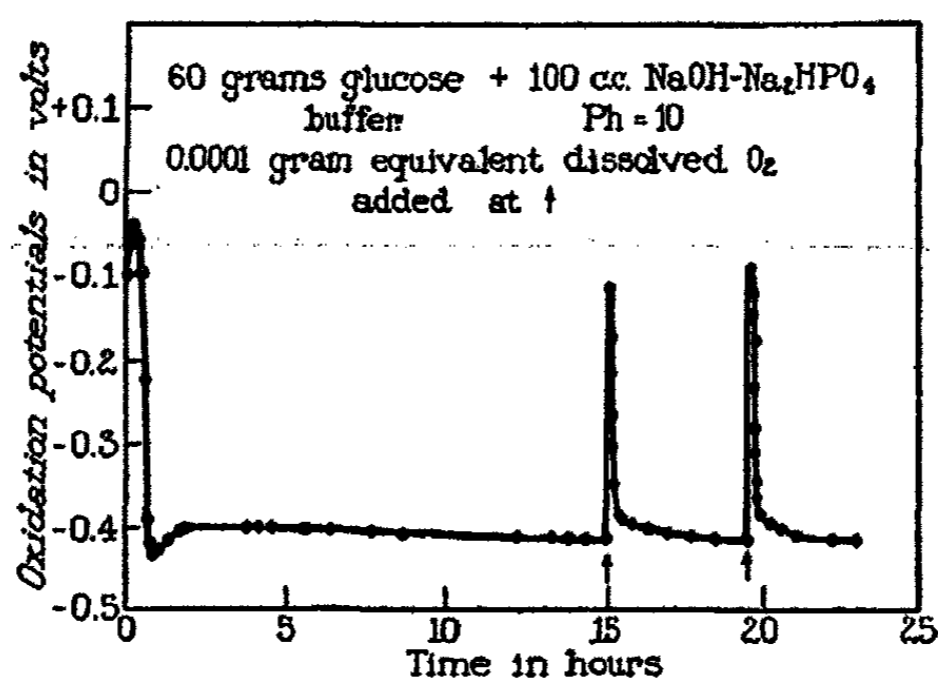

FIG. 3

Recovery to high reducing intensities after additions of oxidant. All effects are repeatable.

clude that exposure to the air for the short time necessary to dissolve the sugar and to fit the chambers into the apparatus before the solutions are deoxidized by nitrogen gas does not affect our results.

The values for the peak voltages were determined as follows: Excluding freak results which occasionally occur, the actual points for the voltages as observed in about a hundred separate runs were plotted. Although the scattering of these values was greater than that observed for the potentials at the end of the fifteen-hour period, it could be seen that the points clustered together around the average values given in Fig. 2. On drawing a curve through these clusters in a way fairly to represent the trend of events, it was obvious that the point of inflection of the curve could be fixed to within 0.25 c.c., that is, 0.0000025 gm. equivalent of oxidant or 10 per cent of the amount needed to combine with the active sugar. If the first oxidation change of glucose be assumed to be bivalent (loss of 2 H<sup>+</sup> ions) then the total sugar present is 0.67 gm. equivalent and the active sugar is present 1 part in 266,000 parts  $\pm$  10 percent.

If the time drifts of potentials in these concentrated glucose solutions are observed continuously, beginning as soon after starting the deaeration with

nitrogen gas as the salt bridges and other connections can be made, drifts will be noticed (Fig. 3). The variations immediately after starting are, of course, rapid and erratic. The first peak in the curve will not always be observed. From then on, however, the curve represents the consistent course of events. The slow slope downward after about three hours represents the preliminary equilibrium which has been mentioned.

Aubel, Genevois and Wurmser,<sup>2</sup> and Wurmser<sup>14</sup> also determined the potentials which reducing sugars, buffered with phosphates, reach in the absence of oxygen at different temperatures and hydrogen-ion concentrations. Their results, when allowance is made for differences in concentration, and so forth, seem to be in fair agreement with our potentials as observed on standing, although their experiments were carried on for a much longer time.

At the points marked with arrows 0.00001 gm. equivalent of oxidant (10 c.c. distilled water) was added. This is, of course, a considerable excess of oxidant over active sugar and the rise in oxidation potential is considerable. Nevertheless the recovery is complete and rather rapid at first. The ability to repeat is proof of the existence of a dynamic equilibrium furnishing a fresh supply of active glucose when that present is destroyed.

In attempting to get an idea of the rate at which the active glucose appears, solutions were next investigated at six hours after the nitrogen gas was turned on. The starting potentials were, of course, slightly higher than at fifteen hours. The peaks were also found to be somewhat higher but when plotted gave a curve similar to that in Fig. 2 with the inflection at 2.5 c.c. Therefore the amount of active reductant at this time is also about 1 part in 266,000 parts of total glucose. The slow progress of secondary and side reactions have doubtless resulted in sufficient byproducts at fifteen hours slightly to affect the actual potentials observed, although the fact that their relative values after additions of oxidant are the same shows that the amount of the most intense reductant is practically the same at six hours as at fifteen hours. Similar observations were made at three and a half hours. Therefore we conclude that at least as soon as the first fluctuations are over there exists in these glucose solutions 1 part in 266,000 parts of a special or active form. Whether these facts and figures also hold true for fresh solutions immediately after dissolving in the open air cannot of course be decided at present. This cannot be tested by our technic until the voltage drifts are at least fairly slow.

A consideration of Fig. 2 shows that its steep part and point of inflection come in the middle of the curve. A titration curve of a typical reversible oxidation-reduction system also has its point of inflection in the middle but its steep vertical parts are at the ends. This fact and the fact that the potentials acquired after repeated identical additions of oxidant are only slightly different show that the first oxidation product of glucose is not electromotively active at the range of potentials belonging to active glucose. Hence we have, in this respect, a condition similar to acid-base titration in which the product, water, does not appreciably affect the electrode potentials since  $H^+$  or  $OH^-$  ions from other sources are so much more numerous. There-



fore the titration curve of this reductant is of a form similar to acid-base titration curves.

Since it is well known that traces of iron have considerable catalytic effect on the oxidation of sugars by air, the influence of small amounts of iron on these titrations was investigated. For the point might be raised that the titrations were simply determining the amount of iron present undergoing oxidation and reduction. Quantitative determinations of iron in these solutions revealed its presence in amounts of the same order of magnitude as the value noted for active sugar. Solutions were, therefore, prepared in which one and two times the amount of iron as  $\text{FeCl}_3 \cdot 6\text{H}_2\text{O}$ , equivalent to the amount of active glucose present, was added. The reduction potential of these solutions after fifteen hours was also  $-0.406$  volt. When they were titrated potentiometrically it was found that the curve for one equivalent of iron falls slightly under the curve in Fig. 2 for the sample of Merck's CP dextrose used and that the curve for two equivalents is slightly lower still. However, their points of inflection both came at approximately 2.5 c.c. and not at 5.0 and 7.5 c.c., as might be expected if valence changes in iron were alone being titrated. It was noted that the presence of iron seemed to make the potentials a little more definite and more closely reproducible.

Hence we conclude that the glucose equilibrium has present in it a form which is chemically much more active than the main bulk and that although its activity in connection with oxidants may be somewhat increased by small amounts of iron, its amount is not; that is inherent within the equilibrium of the sugar itself.

The chemical identity of the active form or the mechanism by which this form is produced from ordinary glucose is of course not revealed by these experiments. Since sugar oxidation is favored by increasing alkali whereas in general an oxidant exhibits a higher oxidation intensity in acid solutions, it is evident that the preponderant effect of the  $\text{OH}^-$  ions is on the sugar molecule. The simplest way in which they could act would be by the removal of  $\text{H}^+$  ions. However, the process is obviously not one of simple neutralization, for the glucose is not appreciably converted into sodium salt even in the presence of a large excess of sodium hydroxide. Yet the active reductant may be simply the negatively charged residues or ions which are left after a splitting off of  $\text{H}^+$  ions which can only occur when the configuration of the glucose molecule is temporarily strained so as to favor this. The minute amount of the active form present shows that the probability of any given molecule existing in a state to favor this change is small and also that the average life of such an ion is short. The tendency to recombine and revert to the inactive state even though comparatively few  $\text{H}^+$  ions are present in alkaline solutions must be great; otherwise more of the active form would accumulate and sugar would be oxidized more easily. If this picture of the active form is true, it is evident that the excess electrons of these ions must be in a more exposed position on the molecule than those on the common anions because these latter do not exert so intense a force of reduction.

A few preliminary determinations made on glucose solutions containing only 30 gm. of glucose instead of 60 gm. seem to be in accord with this postulate. That is, they gave a proportion slightly greater than 1 part in 266,000 parts, although the difference was near the limit of experimental error in determining such small amounts of chemical change. In a more dilute solution the degree of ionization, if the equilibrium point may be so named, would be expected to be greater.

From the point of view of the organic chemistry involved, other easily oxidizable forms of glucose might be postulated. Originally the aldehydic form was supposed to be the "active glucose." If ordinary glucose exists in the form of a lactal ring this might break and form a free radical. Or an enediol, or its methylenol cleavage product, may be present and active in this respect. For a consideration of these and other theories of the possible constitution of active glucose the works of Nef,<sup>9,10</sup> Evans and his associates,<sup>3, 4, 5, 6</sup> Amick, Hudson and Dale, Stieglitz, and especially the review by Levene<sup>8</sup> should be consulted. The purpose of this paper is merely to present further quantitative evidence that there is an active glucose. Whatever its form, it exists in a definite although minute amount in equilibrium with the main bulk of ordinary and comparatively inactive glucose.

#### Summary

Further evidence is submitted that in solutions of glucose there exists a small but definite amount of a very powerful reductant or "active glucose," which alone is responsible for the reduction intensities developed in these solutions. It is shown that this active form is almost instantly destroyed by even a mild oxidant and exists in dynamic equilibrium with the main bulk of inactive or ordinary glucose, since it is in time replaced when so destroyed. Under the conditions of the experiments herein reported the amount of active glucose was found to be 1 part in 266,000 parts + 10 percent.

#### Bibliography

- <sup>1</sup> C. A. Amick: *J. Phys. Chem.*, **31**, 1441-1477 (1927). The copper number for glucose.
- <sup>2</sup> E. Aubel, L. Genevois and R. Wurmsler: *Compt. rend. Acad. d. Sc.*, **184**, 407-409 (1927). Sur le potentiel apparent des solutions de sucres réducteurs.
- <sup>3</sup> W. L. Evans, C. A. Buehler, C. D. Looker, R. A. Crawford and C. W. Hall: *J. Am. Chem. Soc.*, **47**, 3085-3098 (1925). The mechanism of carbohydrate oxidation. I.
- <sup>4</sup> W. L. Evans and C. A. Buehler: *J. Am. Chem. Soc.*, **47**, 3098-3101 (1925). The mechanism of carbohydrate oxidation. II.
- <sup>5</sup> W. L. Evans, R. H. Edgar and J. P. Hoff: *J. Am. Chem. Soc.*, **48**, 2665-2677 (1926). The mechanism of carbohydrate oxidation. IV.
- <sup>6</sup> W. L. Evans and J. E. Hutchman: *J. Am. Chem. Soc.*, **50**, 1496-1503 (1928). The mechanism of carbohydrate oxidation. VIII.
- <sup>7</sup> C. S. Hudson and J. K. Dale: *J. Am. Chem. Soc.*, **39**, 320-328 (1917). Studies on the forms of d-glucose and their mutarotation.
- <sup>8</sup> P. A. Levene: *Chem. Rev.*, **5**, 1-16 (1928). Active Glucose.
- <sup>9</sup> J. U. Nef: *Ann. d. Chem.*, **357-358**, 214-312 (1907). Ueber das Verhalten der Zuckerarten gegen die Fehlingsche Lösung, sowie gegen andere Oxydationsmittel.
- <sup>10</sup> J. U. Nef: *Ann. d. Chem.*, **903**, 204-383 (1914). Dissoziationsvorgänge in der Zuckergruppe.
- <sup>11</sup> J. M. Ort: *J. Opt. Soc. America and Rev. Sci. Inst.*, **13**, 603-608 (1926). Apparatus for determining oxidation-reduction potentials.
- <sup>12</sup> J. M. Ort: *J. Phys. Chem.*, **33**, 825-841 (1929). Ultraviolet light, insulin, and amino acid catalysis.
- <sup>13</sup> Julius Stieglitz: *Proc. Inst. Med. Chicago*, **1**, 41-50 (1916). The oxidation of carbohydrates.
- <sup>14</sup> René Wurmsler: *Compt. rend. Acad. d. Sc.*, **185**, 1038-1041 (1927). Sur le potentiel apparent des solution de glucose.

## THE ELECTROMOTIVE FORCE OF ZINC AMALGAMS\*

BY J. L. CRENSHAW

In a recent article, Pearce and Eversole,<sup>1</sup> have repeated the measurements of the author<sup>2</sup> on the electromotive force of zinc amalgams and state that their results agree with the earlier results of Richards and Forbes<sup>3</sup> and disagree with those of the author. It is the purpose of the present paper to show that, with the possible exception of the most dilute amalgam, all three investigators are in surprisingly good agreement. The apparent discrepancy is due to the fact that Pearce and Eversole, following Hildebrand,<sup>4</sup> in calculating the deviations of my amalgams from ideal solutions, have used as a standard the electromotive force of the most dilute amalgam quoted. It appears that my measurement on this one amalgam was in error, (about 0.14 mv.) and this has caused an apparent error of this amount in all the others.

Pearce and Eversole's most concentrated amalgam contained 2.22 grams of zinc in 100 grams of mercury which must be very close to the concentration of a saturated amalgam at 25°,—the two-phase amalgam used as a reference electrode in my work.<sup>5</sup> Their actual measurements may therefore be directly compared with mine. It is not possible to show any differences between the two series of results in a plot of a size suitable for reproduction. I have therefore interpolated from Pearce and Eversole's measurements, values for the electromotive force of amalgams used by me. In Table I,  $X_{Zn}$  represents the mol-fraction of zinc in the amalgams used by me;  $E_o$  the observed electromotive force in millivolts against the two-phase amalgam;  $E_{o_1}$  and  $E_{o_2}$  the values obtained by adding to Pearce and Eversole's nearest measured value the amount

(always small) calculated from the equation  $E = \frac{RT}{nF} \log_{10} \frac{a_1}{a_2}$  where  $a_1$  repre-

sents the activity of the zinc in my measured amalgam and  $a_2$  that of the zinc in Pearce and Eversole's amalgam of nearly the same concentration. In the column marked  $E_{o_1}$  the values for the activities are taken from a large scale plot of Pearce and Eversole's values. In column  $E_{o_2}$ , the values of the activities are taken from my own measurements (Fig. 1).

\* Contribution from the Department of Chemistry, Bryn Mawr College.

<sup>1</sup> J. Phys. Chem., 32, 209 (1928).

<sup>2</sup> J. Phys. Chem., 14, 158 (1910).

<sup>3</sup> Pub. Carnegie Inst., 56; Z. physik. Chem., 58, 683 (1907).

<sup>4</sup> J. Am. Chem. Soc., 35, 501 (1913).

<sup>5</sup> Pearce and Eversole state that this was a two-phase amalgam but they apparently had only enough zinc to saturate the mercury at 25° so that no solid phase was present. The electromotive force of such an amalgam is obviously not as constant and reproducible as that of a two-phase amalgam since any loss of zinc due to oxidation or other causes would cause a change in electromotive force. Its composition also is dependent on the accuracy with which the zinc and mercury are weighed out.

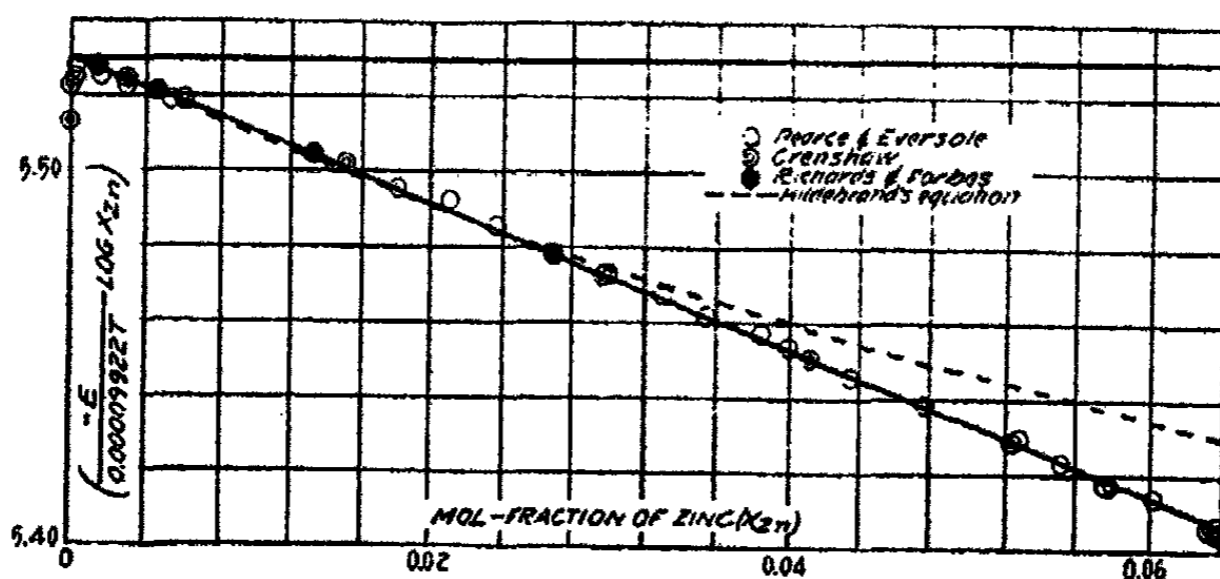

FIG. 1

TABLE I

$X_{Zn}$	$E_0$	$E_{01}$	$E_{c1}$	$E_{c1} - E_0$
0.06738	0	0	0	0
0.05782	0.88	0.94	0.95	+0.06
0.05234	1.83	1.86	1.84	+0.03
0.04119	4.26	4.31	4.30	+0.05
0.02977	7.78	7.82	7.81	+0.04
0.01511	15.62	15.72	15.70	+0.10
0.006099	26.77	26.89	26.89	+0.12
0.003058	35.47	35.59	35.59	+0.12
0.0003068	65.00*	64.97	64.97	-0.03

\* This was the value 10 hours after the amalgam was prepared. Five hours after preparation it was 64.94.

The two calculated columns are practically identical since the two concentrations used for calculation were always very close together, and only the relative activities are involved.

The differences between observed and calculated electromotive force given in Table I are certainly larger than the experimental error in the determination of the electromotive force, but probably not greater than the error in determining the composition of the dilute amalgams. Very dilute amalgams do lose zinc even when every precaution has been taken to exclude oxygen and when the cell has been closed with well-ground glass joints cemented in.<sup>1</sup> It will be noticed in Table I that all of the values (except the last) calculated from Pearce and Eversole's observations are higher than my observed values. If the electromotive force was correctly measured, this seems to show that there were greater differences in concentration between the saturated amalgam and those measured against it in their investigation than there were for amalgams of supposedly the same concentration in mine. A possible explanation is that their dilute amalgams had lost some of their zinc, and the more dilute the amalgam the more the relative loss. In the

<sup>1</sup> Crenshaw: loc. cit.

last amalgam in Table I, my amalgam had apparently lost slightly more zinc than theirs. This amalgam, designated as  $1/10^4$  in my earlier paper and taken as a standard by Hildebrand and by Pearce and Eversole, was undoubtedly losing zinc while I measured it. In spite of this, it is seen that the first measurements<sup>1</sup> on this amalgam agree better with the measurements of Pearce and Eversole than do the values for the more concentrated amalgams immediately preceding it in the table. If these amalgams had also lost small appropriate amounts of zinc, my results would have agreed exactly with those of Pearce and Eversole. There is evidence that my more concentrated amalgams were not losing zinc since their electromotive force against the two-phase remained constant for weeks. The differences in the last column of Table I do not explain Hildebrand's and Pearce and Eversole's criticism of my results, since if the last difference had been  $+0.12$  instead of  $-0.03$ , the deviation of my amalgams from ideal solutions as plotted by them would have agreed very closely with the deviations they obtained from the results of Richards and Forbes. As will be shown, it was the error in my measurement of this last amalgam, and not the differences shown in Table I for the more concentrated amalgams, which was responsible for the apparent disagreement between my results and those of Richard and Forbes, and Pearce and Eversole.

Richards and Forbes' value were obtained at  $23^\circ$  but since the activities change very little with the temperature, their measurements may also be compared with those at  $25^\circ$ . None of their amalgams was identical with any one of the other two investigations so that the above equation must be used for calculating the whole of the electromotive force.  $-E_0$  in Table II is the value observed by them against their most dilute amalgam. The other columns have the same significance as in Table I.

TABLE II

$X_{Zn}$	$-E_0$	$-E_{01}$	$E_0 - E_{01}$	$-E_{02}$	$E_0 - E_c$
0.001411	0	0	0	0	0
0.004610	14.91	14.93	+0.02	14.92	+0.01
0.01323	27.86	27.92	+0.06	27.90	+0.04
0.02691	36.15	36.24	+0.09	36.16	+0.01

Assuming that I have calculated the activities correctly from my measurements, my values seem to be in slightly better agreement with those of Richards and Forbes than are the values of Pearce and Eversole.

The good agreement of the three investigations can be shown by plotting the expression  $\left(\frac{-E}{0.00009922T} - \log X_{Zn}\right)$  against the mol fraction of zinc<sup>2</sup> as in Fig. 1. The absolute values of the ordinates depend on the amalgam chosen

<sup>1</sup> The first measurement, made five hours after the amalgam was prepared, was 64.94 mv. This had increased to 65.23 mv. at the end of one day. loc. cit.

<sup>2</sup> Lewis and Randall: "Thermodynamics," 266 (1923).

for reference, but since the logarithm of the activity coefficient,  $\log (a_{Zn}/X_{Zn})$ , which may be read directly from such a plot, depends only on the relative value of the ordinates, the results of different investigations may be brought together by adding an appropriate constant to the values obtained from any series of measurements.  $-E$  has been taken as the value of the electromotive force in volts against the most dilute amalgam, except in the case of my own results, where the  $1/10^6$  amalgam, which is obviously incorrect, has been taken as a standard. To the values of  $\left(\frac{-E}{0.00009922T} - \log X_{Zn}\right)$  thus obtained from the data of Pearce and Eversole, 2.0085 has been added. To the values from the work of Richards and Forbes, 2.6775 has been added. It will be seen that, except for the dilute amalgams, all of the results lie on a straight line, within the limits of experimental error. The extrapolation to infinite dilution is somewhat questionable. Richards and Forbes' most dilute amalgam lies exactly on this same straight line, while Pearce and Eversole's last four values are slightly below it (0.06 in terms of millivolts), though parallel to it. My last three results show progressively greater loss of zinc. If my  $1/10^4$  amalgam, the most dilute quoted by Hildebrand, and Pearce and Eversole, had given an electromotive force against the two-phase amalgam 0.14 mv. lower than it did, it would have given a point exactly on the line. Since a very slight loss of zinc would cause the dilute amalgams to give points below the line and since there is evidence of loss from the first of my amalgams which falls below the line, it seems best to continue the straight line to the axis of ordinates. The values which the expression  $\left(\frac{-E}{0.00009922T} - \log X_{Zn}\right)$  would give if the electromotive force agreed with Hildebrand's equation (see below) have been plotted in Fig. 1. This also indicates that there should be no downward curvature in the line as infinite dilution is approached. From this straight line a value of 5.5303 is obtained for the ordinate at infinite dilution. The logarithm of  $a_{Zn}/X_{Zn}$  for any amalgam is obtained directly from the plot by subtracting from its ordinate the ordinate at infinite dilution. The absolute value of the activity is therefore dependent on the value chosen for the ordinate at zero concentration of zinc. If Pearce and Eversole's value for the limiting ordinate is chosen, their four most dilute amalgams give the same value for  $a_{Zn}/X_{Zn}$  (within 0.001) as are obtained from the line of Fig. 1; their more concentrated amalgams, however, will all give higher values than those obtained from the plot, the greatest difference being for the saturated amalgam where they obtain  $a_{Zn}/X_{Zn} = 0.755$ , whereas Fig. 1 gives 0.749. The plot shows, however, that except for my three most dilute amalgams, the three investigations agree surprisingly well, no point being off the line as drawn by more than 0.06 millivolts and that only in the most dilute part of the range. For calculating the electromotive force between two amalgams as in Table II, only the slope of the line and not the limiting value of its ordinate is used. The line as drawn fits the values of Richards and Forbes better than one drawn from Pearce and Eversole's data alone.

Fig. 1 also enables one to calculate the deviations of the amalgams from ideal solutions (assuming the extrapolation to infinite dilution to be correct) without the necessity for any assumption as to the association of the dissolved zinc, such as was made by Hildebrand, and Pearce and Eversole. The horizontal line drawn from the limiting ordinate represents the constant value the

expression,  $\left(\frac{-E_0}{0.00009922T} - \log X_{Zn}\right) + C = \text{ordinate}$ , would have if the amal-

gams were ideal. That is  $\left(\frac{-E_1}{0.00009922T} - \log X_{Zn}\right) = 5.5305 - C$  where

$E_1$  is the electromotive force an ideal amalgam of mol-fraction  $X_{Zn}$  would give against the amalgam taken as a standard, and  $C$  is the arbitrary constant added, if any. Subtracting the second of these expressions from the first (which is equal to the ordinate at  $X_{Zn}$  of the curve in Fig. 1), and re-arranging, we get  $E_1 - E_0 = (\text{ordinate} - 5.5303) 0.00009922 T$ ; so that the difference  $E_1 - E_0$  is obtained for  $25^\circ$  for any amalgam by multiplying the vertical distance, at the given value of  $X_{Zn}$ , between the curve and the horizontal line in Fig. 1 by the factor .029577. The only uncertainty in this method is due to uncertainty of the limiting value of the ordinate. It, at least, gives no undue weight to the more dilute amalgams. Hildebrand and Pearce and Eversole in calculating the deviations of my amalgams from ideal solutions, used my  $1/10^4$  amalgam as a standard. This is equivalent to drawing the horizontal line in Fig. 1 through the point corresponding to this amalgam, that is, with the ordinate 5.5249 instead of 5.5303. To do this would be to place the whole weight of extrapolation on one measurement which was admittedly inexact. If the  $1/10^5$  or the  $1/10^6$  amalgam had been taken as a standard, the agreement between my results and the others quoted would, of course, have been worse. Although the deviations of the amalgams from ideal solutions may be read almost directly from Fig. 1, it seems advisable to plot these deviations in the same way in which they were plotted by Hildebrand and by Pearce and Eversole. Such a plot was used by them to show that my results did not agree with those of Richards and Forbes and with Hildebrand's equation.

In Fig. 2, the differences between the observed electromotive forces and those which would have been given if the amalgams formed ideal solutions are plotted against  $\log N$  (the number of mols of mercury containing one mol of zinc). For my measurements, this difference has been calculated from Fig. 1 as explained above. Pearce and Eversole's differences are taken directly from their paper. Richards and Forbes' differences have been calculated by the method used by Hildebrand and are practically identical with those given by him. The logarithm of  $N$  has been used as abscissae in order to include more easily the differences which would have resulted if the observed electromotive forces had been those calculated from Hildebrand's equation

$$E = \frac{RT}{nF} \log_0 \frac{1 + N_2 + \sqrt{N_2^2 + 2AN_2 + A}}{1 + N_1 + \sqrt{N_1^2 + 2AN_1 + A}}$$

where  $N_1$  and  $N_2$  represent the mols of mercury to one of zinc in two amalgams and  $A$  is a constant. This equation depends on two assumptions: (1) that the vapor pressure of mercury from an amalgam is given by Raoult's Law,  $p_{Hg} = p_{Hg0}X_{Hg}$  and (2) that the mol-fraction of mercury may be calculated by assuming an equilibrium between biatomic and monatomic molecules of zinc in the amalgam, given by the equation  $X_{Zn_2}/X_{Zn}^2 = K$ , where  $X_{Zn_2}$  represents the mol-fraction of biatomic molecules and  $X_{Zn}$  the mol-fraction of monatomic molecules. Figs. 1 and 2 show clearly that the results of the three series of measurements agree much better with each other than they do with Hildebrand's equation. The differences given by Pearce and Ever-

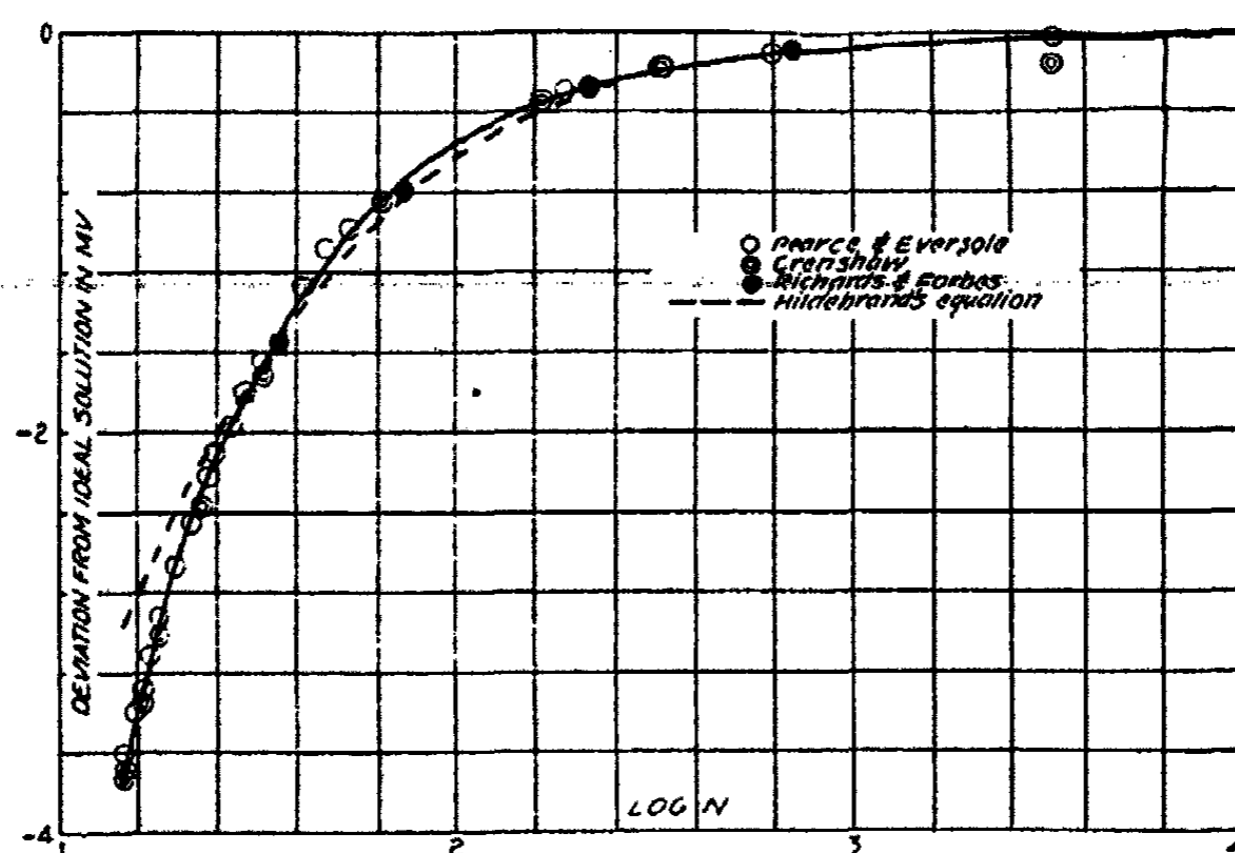

FIG. 2

sole between their observed electromotive forces and those calculated from Hildebrand's equation are, for all amalgams where  $X_{Zn}$  is greater than 0.0355, all larger than the actual differences in the values observed by them and by me as given in column 5 of Table I. The agreement between Hildebrand's equation and the results of Richards and Forbes is due to the fact that their four measurements covered a rather narrow range of concentration. By properly choosing a value for  $A$ , Hildebrand's equation may be made to fit any short part of the observed curve. The value of  $A$  actually used in this paper is the value originally given, 11.6. If a larger value is used, it gives better agreement with the more concentrated amalgams but less good agreement in the dilute range. If assumption (1) above is correct, as it seems reasonable to suppose, assumption (2) must be in error. It is possible that at 25° a higher polymerization of zinc becomes appreciable, though at 300° it appears to have been negligible.<sup>1</sup> An equation allowing for the presence of

<sup>1</sup> Hildebrand: *Trans. Am. Electrochem. Soc.*, 22, 319 (1913).



$Zn$ ,  $Zn_2$  and  $Zn_4$  could possibly be made to fit the results over the whole range, but without independent evidence of the existence of  $Zn_4$  such a calculation seems unjustified.

#### Summary

1. The measurements of the electromotive force of zinc amalgams by Richards and Forbes, Pearce and Eversole, and the writer have been compared by a method which gives no undue weight to the most dilute amalgams where the error of measurement is admittedly highest.

2. When so compared, the results of the three investigations are in excellent agreement.

3. The three investigations agree much better with each other than with Hildebrand's equation.

*Bryn Mawr, Pennsylvania.*

# THE HEAT OF ADSORPTION OF CARBON DIOXIDE ON CHARCOAL CALCULATED BY MEANS OF POLANYI'S THEORY OF ADSORPTION\*

BY J. K. DIXON

Polanyi's theory of adsorption has been applied successfully to the adsorption of certain vapors by charcoal.<sup>1</sup> Lowry and Olmstead<sup>2</sup> showed that this theory could be used to calculate the adsorption isotherms of carbon dioxide on charcoal at any temperature between 0 and 100°C., if one experimental isotherm was given. The experimental data and theory agreed better as the experimental accuracy increased. They also indicated that the theory might be used to calculate heats of adsorption (p. 1610). Magnus and Kälberer<sup>3</sup> measured the heats of adsorption of carbon dioxide on charcoal at 0°C. and the corresponding equilibrium pressures and amounts adsorbed. The present paper gives a comparison of the heats of adsorption calculated by the theory of Polanyi and the experimental values of Magnus and Kälberer.

## The Adsorption Isotherms

Magnus and Kälberer determined the heats of adsorption and adsorption isotherms on charcoals outgassed at 600°C. and at 100°C. Their experimental pressures and the corresponding amounts of carbon dioxide adsorbed have been reduced to centimeters of mercury and milligrams of gas adsorbed per gram of charcoal, respectively. Their data give the heats in calories per mol of gas adsorbed, expressed in the units to be used here.

By means of the tables and method of calculation given in the paper of Lowry and Olmstead, it is possible to compare the results of Magnus and Kälberer with the adsorption isotherms calculated by means of Polanyi's theory. From Lowry and Olmstead's Table I were taken the values<sup>4</sup> necessary for constructing an  $\epsilon_1-\delta_1$  curve at 273.1°K. From their Table II a  $p-\Delta\epsilon$  curve was constructed on a large scale and the values of  $\Delta\epsilon$ , corresponding to the pressures given by Magnus and Kälberer, were read off this plot.  $\Delta\epsilon$  could not be evaluated accurately at low pressures by this method. Therefore,  $V\delta_x$  was calculated by means of the perfect gas equation and  $\Delta\epsilon$  then calculated by equation (18) of Lowry and Olmstead. An approximate  $\epsilon-\phi$  curve was constructed and corrected four times in the usual way by successive approximations. The final curves for the charcoals outgassed at

\* Contribution from the Department of Chemistry, Yale University.

<sup>1</sup> Polanyi and Goldmann: *Z. physik. Chem.*, **132**, 321 (1928). The application of the theory to vapor adsorption is presented fully in this paper.

<sup>2</sup> Lowry and Olmstead: *J. Phys. Chem.*, **31**, 1601 (1927).

<sup>3</sup> Magnus and Kälberer: *Z. anorg. allgem. Chem.*, **164**, 345 (1927).

<sup>4</sup> The notation used here is the same, throughout.

100°C. and 600°C. are shown in Fig. 1. The  $\epsilon$ - $\varphi$  curve for the adsorption of carbon dioxide by Columbia Activated Charcoal at 0°C. is plotted also, the necessary values of  $\epsilon$  and  $\varphi$  being taken from Table IV of the paper of Lowry and Olmstead.

Tables I and II give the results of the calculations. The first column gives the measured pressure in centimeters of mercury, the second  $\epsilon_s$  in calories per mol, the third the volume of gas adsorbed,  $\varphi_s$ , in cubic millimeters, the fourth

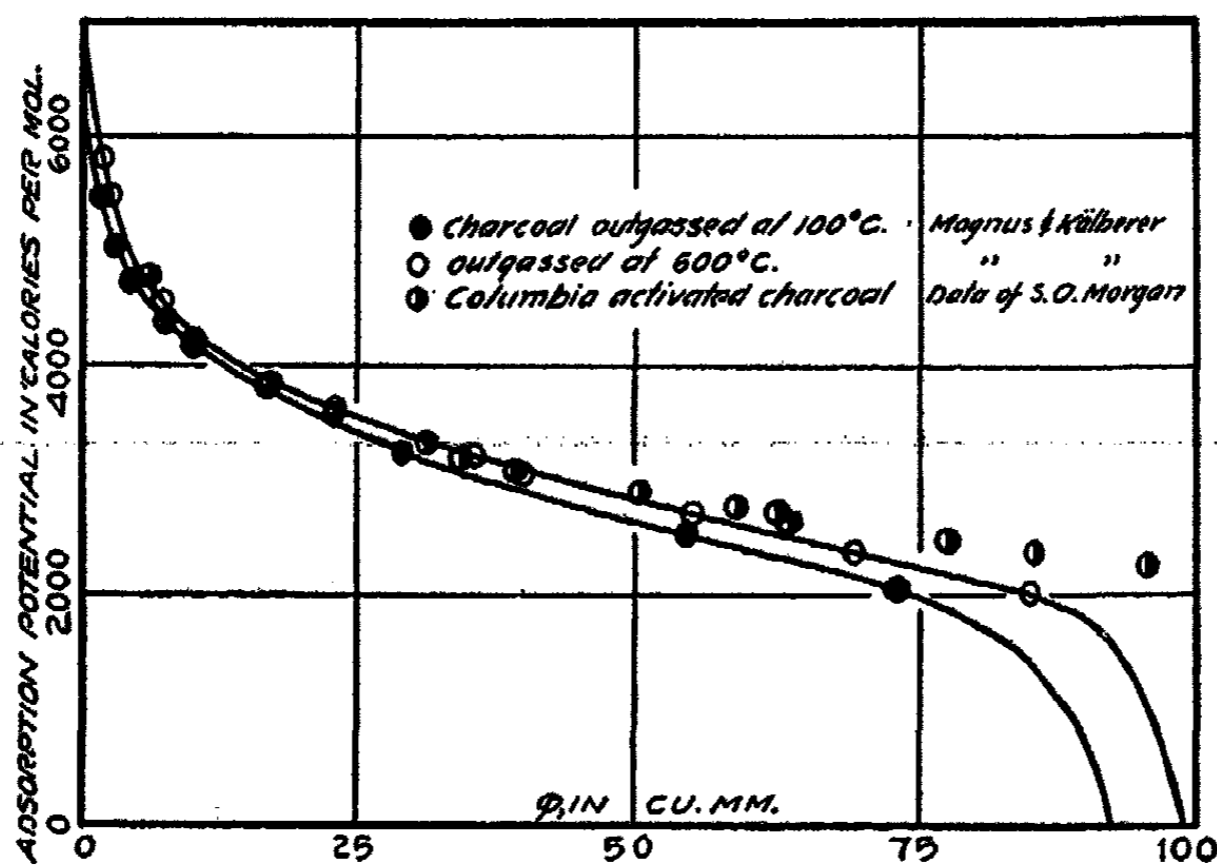

FIG. 1

Adsorption potential curves for carbon dioxide on charcoal.

the density,  $\delta_s$ , in grams per cubic centimeter, and in the fifth and sixth are recorded the observed and calculated values, respectively, of the amounts of carbon dioxide adsorbed in milligrams per gram of charcoal. The differences between the calculated and observed results are given in the seventh column. The mean differences are well below 1%. A poor experimental determination probably shows up in the way illustrated in Table II for the pressure of 7.01 cms.

TABLE I

Data from experimental work of Magnus and Kälberer.  
Charcoal outgassed at 100°C. Temperature = 273.1°K.

P	$\epsilon_s$	$\varphi_s$	$\delta_s$	X <sub>obs.</sub>	X <sub>calc.</sub>	$\frac{X_{calc.} - X_{obs.}}{X_{obs.}} \times 100$
0.092	5466	1.4	1.023	1.71	1.68	-1.76
0.200	5044	2.8	1.070	3.40	3.43	+0.88
0.354	4734	4.3	1.088	5.21	5.24	+0.58
0.690	4372	7.5	1.093	9.02	8.96	-0.67
1.00	4171	10.1	1.094	11.93	11.95	+0.17
5.64	3230	29.4	1.128	34.60	34.82	+0.64
21.11	2515	54.6	1.150	63.85	64.04	+0.30
50.57	2040	73.0	1.174	86.40	86.43	+0.03

TABLE II  
Data from experimental work of Magnus and Kälberer  
Charcoal outgassed at 600°C. Temperature = 273.1°K.

P	$\epsilon_s$	$\psi_s$	$\delta_s$	$x_{obs.}$	$x_{calc.}$	$\frac{x_{calc.} - x_{obs.}}{x_{obs.}} \times 100$
0.0484	5814	1.7	1.111	1.947	1.939	-0.41
0.0890	5483	2.3	1.114	2.84	2.81	-1.06
0.489	4559	7.3	1.120	8.89	8.86	-0.34
1.830	3842	17.0	1.115	20.45	20.58	+0.64
2.690	3633	23.0	1.127	27.1	27.0	-0.37
5.820	3210	35.8	1.133	41.9	41.8	-0.24
7.01	3040	39.9	1.147	46.4	48.9	+5.39
15.03	2700	55.2	1.163	64.7	64.7	0.00
27.88	2368	69.3	1.179	81.8	81.6	-0.24
52.11	2020	84.4	1.078	100.0	100.1	+0.10

### The Heats of Adsorption

The heat of adsorption of a gas,  $q$ , in calories per mol adsorbed, is related to  $\epsilon$  and  $x$  by the equation:

$$q = \frac{\int_0^{x_{tot.}} \epsilon dx}{x_{tot.}} \quad 1)$$

Where  $x_{tot.}$  denotes the total amount of carbon dioxide adsorbed. The heat of adsorption of the carbon dioxide at any desired pressure was found by plotting  $\epsilon$  vs.  $x$ , finding the area under this curve graphically and then dividing this area by  $x_{tot.}$  Table III illustrates clearly how the corresponding values of  $\epsilon$  and  $x$  were obtained.

TABLE III  
p = 0.489 cms. T = 273.1°K. Charcoal outgassed at 600°C.

$\delta_1$	$\epsilon_1$	$\epsilon_2$	$\epsilon_1 - \epsilon_2$	$\delta_1 + \delta_2/2$	$\Delta x$	$x$	$\epsilon_1 + \epsilon_2/2$
	2739	53.4					
0.01	3596	23.8	29.6	0.005	0.148	8.862	3168
0.05	4351	9.3	14.5	0.030	0.435	8.714	3974
0.08	4518	7.7	1.6	0.065	0.104	8.279	4435
0.09	4559	7.3	0.4	0.085	0.034	8.175	4539
0.91	4559	7.3					
1.0	4724	6.0	1.3	0.955	1.241	8.141	4642
1.1	5064	3.8	2.2	1.050	2.310	6.900	4894
1.2	5651	2.0	1.8	1.150	2.070	4.590	5358
1.3	6664	0.2	1.8	1.250	2.250	2.520	6158
1.4	8524	0.0	0.2	1.350	0.270	0.270	7594

$$\text{Area under } \epsilon - x \text{ curve} = 49470 \frac{\text{cal. mg.}}{\text{mol}} = \sum \epsilon dx$$

$$q_{calc.} = \frac{\sum \epsilon dx}{x_{tot.}} = \frac{49470}{8.862} = 5580 \text{ cal./mol}$$

The heats of absorption, calculated in the way just described, are given in Tables IV and V. The first column gives the equilibrium pressure of the carbon dioxide, the second the experimental heats of adsorption of Magnus and Kälberer, and the third the calculated values.

TABLE IV

Charcoal outgassed at 100°C. Temperature = 273.1° K.

p	q <sub>obs.</sub>	q <sub>calc.</sub>	ΔH <sub>calc.</sub>	l	m
0.092	8467	5880	3000	2905	- 0.91
0.200	8247	5720	2850	3130	+ 2.46
0.354	8184	5440	3070	3205	+ 1.42
0.690	8091	5230	3130	3220	+ 0.98
1.00	7917	5175	2800	3225	+ 3.00
5.64	7506	4510	3120	3370	+ 3.25
21.11	7283	3960	3390	3455	+ 0.92
50.51	6739	4040	2720	3555	+ 12.5

TABLE V

T = 273.1° K. Temperature of outgassing = 600°C.

p	q <sub>obs.</sub>	q <sub>calc.</sub>	ΔH <sub>calc.</sub>	l	m
0.0484	10496	6410	4460	3160	- 11.29
0.0890	9597	6350	3675	3300	- 2.58
0.489	8542	5580	3230	3320	+ 1.03
1.830	7910	4930	3200	3340	+ 1.64
2.690	7680	4740	3100	3310	+ 2.48
5.820	7384	4490	3005	3360	+ 4.69
7.01	7268	4330	3033	3420	+ 5.25
15.03	7194	4140	3125	3440	+ 4.40
27.88	7062	3980	3130	3510	+ 5.50
52.11	7006	3885	3140	3560	+ 5.98

The differences between the calculated and observed heats range from 2600 to 3200 calories per mol. They represent the heats of condensation of the carbon dioxide. The theory merely accounts for the heat liberated in compressing the gas from the "free space" to the state in which it exists on the surface of the charcoal. The heat of condensation, ΔH<sub>calc.</sub>, can be calculated by the following equation:

$$\Delta H_{\text{calc.}} \frac{x_s}{x_{\text{tot.}}} = q_{\text{obs.}} - q_{\text{calc.}} \quad 2)$$

Where  $x_s$  is the amount of gas existing at a density greater than that of normal liquid carbon dioxide. The values of ΔH<sub>calc.</sub> are recorded in the fourth columns of Tables IV and V. They agree reasonably well among themselves. The mean of the last eight values in Table V is 4% higher than the mean from Table IV.

The heat of condensation of carbon dioxide, when under its own vapor pressure at 0°C., is 2420 calories per mol. As the temperature decreases, the specific volume of the liquid decreases and the heat of condensation increases.<sup>1</sup> Since the major portion of the carbon dioxide which is adsorbed exists at a density greater than that of the normal liquid at 0°C., it is reasonable to assume that the gas condenses to form a liquid whose density and heat of vaporization are greater than that of the normal. In Tables I and II are given the mean densities,  $\delta_s$ , of the carbon dioxide condensed to the adsorbed state. Using values taken from the literature<sup>2</sup> a plot was made of specific volume,  $(1/\delta_s)$ , against the heat of condensation,  $l$ . The value of  $l$  at any desired equilibrium pressure was read off this curve. The results are given in the fifth columns of Tables 4 and 5. It is apparent that the percentage difference,  $m$ , between the calculated and observed heats of adsorption is

$$m = \frac{\left( q_{\text{calc.}} + l \cdot \frac{x_s}{x_{\text{tot.}}} \right) - q_{\text{obs.}}}{q_{\text{obs.}}} \times 100 \quad 3)$$

The values of  $m$  are given in the sixth columns of Tables IV and V.

A glance at Tables V and VI shows that  $m$  is negative at low pressures. In this pressure range we are dealing with strong adsorptive forces and, consequently, the equation of state used in the development of the theory<sup>3</sup> does not hold. That is, this equation of state does not apply to the cases where we are dealing with the strong molecular fields which exist between the adsorbent and first molecular layer or between any two adjacent layers in which the molecules possess large induced electric moments. We would expect the heat of adsorption in these strong molecular fields to be higher than that calculated by means of the normal equation of state, and it is indicated that this is the case.

In conclusion, it should be pointed out that Polanyi's theory does not involve the assumption that the range of the attractive forces of the adsorbent extends beyond one or two molecular thicknesses.<sup>4</sup> After the first one or two molecular layers are formed, adsorption may be caused by the intermolecular forces existing between the compressed or condensed gas molecules. This is the explanation advanced by Keyes and Marshall<sup>5</sup> based on deductions made from their work on the heats of adsorption of certain gases by charcoal. Polanyi's theory postulates a compression of the gas on the surface of the adsorbent. The calculations of Lowry and Olmstead and the ones recorded here show that this theory agree reasonably well with experimental data.

*New Haven, Conn.*

<sup>1</sup> "International Critical Tables," 5, 138 (1929).

<sup>2</sup> "International Critical Tables," 3, 235; 5, 138.

<sup>3</sup> Lowry and Olmstead: *J. Phys. Chem.*, 31, 1608 (1927).

<sup>4</sup> Polanyi: *Z. Elektrochemie*, 35, 431 (1929).

<sup>5</sup> Keyes and Marshall: *J. Am. Chem. Soc.*, 49, 156 (1927).

# A STUDY OF THE INFLUENCE OF HYDROLYSIS TEMPERATURE ON SOME PROPERTIES OF COLLOIDAL FERRIC OXIDE.

## I. THE PARTICLE SIZE

BY GILBERT H. AYRES AND C. HARVEY SORUM\*

Although colloidal ferric oxide can be prepared by several different methods, the method involving hydrolysis is more commonly used than other types of reaction.<sup>1</sup> Among the hydrolysis methods, that of dropping ferric chloride solution into boiling water seems to have been used most extensively.<sup>2</sup>

References to the influence of hydrolysis temperature on the properties of the sols thus obtained are not numerous. Krecke<sup>3</sup> heated ferric chloride solutions of various concentrations and noted the temperature of formation of "a pale yellow precipitate, an oxychloride, of varying composition according as the heating lasts a shorter or longer time." He also reports that "a solution of 32% ferric chloride at about 140° is partially decomposed with formation of a dark brown substance which is easily soluble in nitric acid. It contains no chlorine and is iron oxide which contains more or less water according as the heating lasts a shorter or longer time."

Weiser<sup>4</sup> mentions that rapid hydrolysis at the boiling temperature gives small, red-brown particles; slow hydrolysis of a dilute solution at ordinary temperature, or of a more concentrated solution heated slowly to the boiling point, produces larger particles that are yellow; boiling the brown or yellow sol causes agglomeration to red particles.

In the light of these references it would seem that the properties of colloidal ferric oxide are influenced by the temperature at which hydrolysis takes place. It was therefore the purpose of this investigation to prepare ferric oxide sols by the hydrolysis of ferric chloride solutions at various temperatures (particularly above 100°) and study the properties of the sols thus obtained.

### Preparation of the Sols

The ferric oxide sols were prepared in an autoclave (Fig. 1) tested to stand a pressure of 2000 pounds per square inch, and fitted with a thermometer well W, pressure gauge P and safety valve V. The inside diameter

\* The authors wish to acknowledge their indebtedness to Dr. J. H. Walton for many valuable suggestions in the course of this study.

<sup>1</sup> Péan de St. Gilles: *Compt. rend.*, 40, 568, 1243 (1855); Graham: *J. Chem. Soc.*, 15, 216 (1862); 17, 318 (1864); Biltz: *Ber.*, 35, 4431 (1902); Neidle: *J. Am. Chem. Soc.*, 39, 76 (1917); Freundlich: *Kolloid-Z.*, 33, 222 (1923).

<sup>2</sup> Ufer: "Über kolloides Eisenoxyd," *Diss.*, Dresden (1915); Hatschek: "Laboratory Manual of Elementary Colloid Chemistry," (1920); van Bemmelen: *Z. anorg. Chem.*, 36, 380 (1903).

<sup>3</sup> Krecke: *J. prakt. Chem.*, (2) 3, 286 (1871).

<sup>4</sup> Weiser: *J. Phys. Chem.*, 24, 277 (1920).

of the autoclave was just sufficient to receive a 200 cc. tall-form Pyrex beaker, X. For the calibration of the pressure gauge this beaker was filled with water and temperatures corresponding to various pressures were recorded, the autoclave being heated with a Meker burner. A pressure-temperature curve was

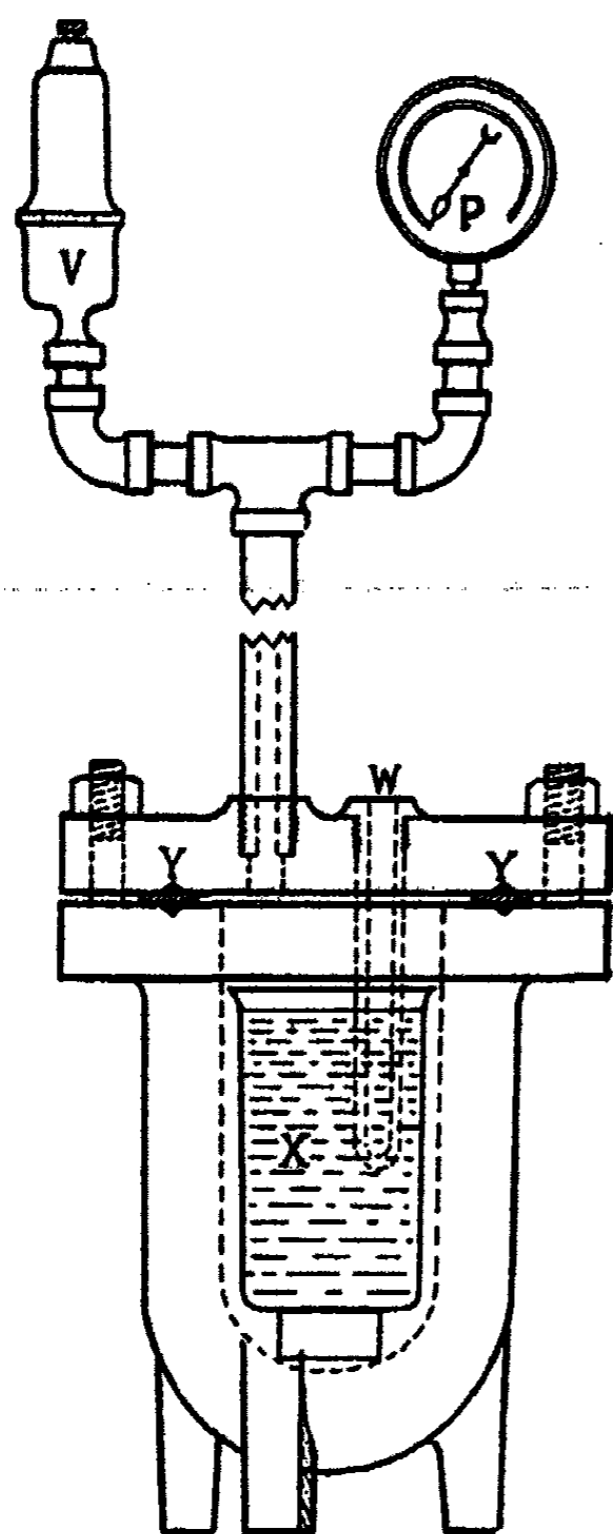

FIG. 1  
Autoclave for High Temperature Hydrolysis

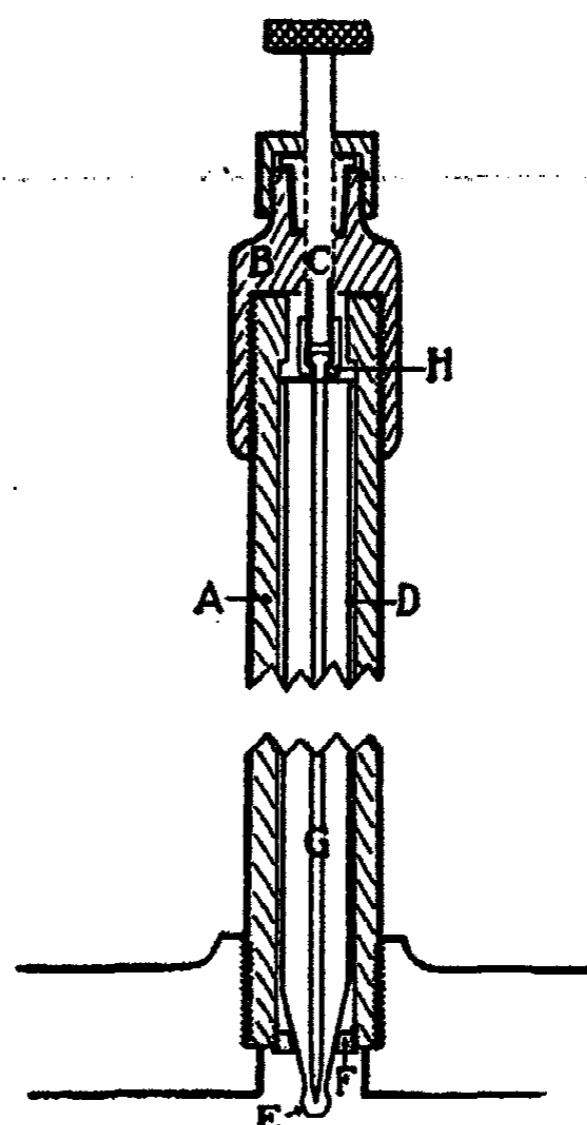

FIG. 2  
Mechanism for introducing Ferric Chloride Solution

constructed so that the temperature corresponding to any pressure could be determined. The thermometer well was then removed and a mechanism for introducing ferric chloride solution fitted in its place. This mechanism (Fig. 2) consisted of a tube A, which was bored out of stock steel rod of 25 mm. diameter and 25 cm. length; the inside diameter of the tube was 14 mm. The top of this steel tube was fitted with a knurled head B, through which passed a  $3/16$  inch screw, C, packed so as to be gas tight. A 12 mm. glass tube D, drawn out and closed at the lower end with a thin-walled glass bulb



E, was held in place inside of the steel tube by means of an annular nut F; a 3 mm. glass rod G, long enough to reach almost to the bottom of the glass tube, was fastened to the screw shaft C by means of a threaded sleeve H, flanged on the inside; the upper end of the glass rod was flattened so as to be held in place by this flange. A 1/4 inch copper tube (not shown in diagram) wound around the steel tube served as a cooling coil to prevent the premature hydrolysis of the ferric chloride solution contained within.

For the preparation of a sol, ferric chloride solution was placed in the 12 mm. glass tube D and the head B bearing the plunger rod G screwed in place; the beaker filled with water was placed in the autoclave and the top assembly, carrying the dropping mechanism, pressure gauge and safety valve, screwed on. A gas tight connection was made by means of a lead gasket fitting into V-shaped grooves in the faces of the upper and lower parts of the autoclave. (See Y, Fig. 1.) The autoclave, in its support, was then heated with a Meker burner; when the desired pressure was reached, the plunger was screwed down so as to break the bulb at the bottom of the glass tube and allow the ferric chloride solution to run into the water where it was hydrolyzed to form colloidal ferric oxide. The burner was immediately turned off; the autoclave was allowed to cool (1-1½ hours) and the sol removed.

In many cases the sols thus prepared contained more or less precipitated iron oxide; this was removed by centrifuging at 1200 r.p.m. for 20 minutes.

All sols were dialyzed 100 hours or longer in collodion bags in the dialyzer described by Sorum<sup>1</sup> and following the procedure and technique developed by him<sup>2</sup> in this laboratory. These sols after dialysis gave negative tests for the presence of chlorides.

Analysis of the sols for ferric oxide content was made by a modified method of Knop.<sup>3</sup> The ferric oxide was dissolved in hydrochloric acid, the ferric chloride reduced with stannous chloride and titrated with potassium dichromate, using diphenyl amine indicator.

#### Determination of Particle Size

From among the methods for determination of particle size described by Kuhn,<sup>4</sup> the method of direct particle count in the ultramicroscope was chosen as being most convenient for this investigation. The visibility of particles in the ultramicroscope depends chiefly upon two factors,<sup>5</sup> namely, "the strength of the illumination, and on how greatly the refractive index of the particles differs from that of the dispersion medium. The difference between the two refractive indices must be adequate to allow a considerable diffraction of the light to take place at all. If dispersed phase and dispersion medium are only slightly different with respect to refractive power, one observes in the ultramicroscope only a uniform feeble brightening."

<sup>1</sup> Sorum: J. Am. Chem. Soc., 50, 1263 (1928).

<sup>2</sup> Sorum: Doctorate Thesis, University of Wisconsin (1927).

<sup>3</sup> Knop: J. Am. Chem. Soc., 46, 263 (1924).

<sup>4</sup> Kuhn: Kolloid-Z., 37, 365 (1927).

<sup>5</sup> Freundlich: "Colloid and Capillary Chemistry," 387 (1926).

All sols studied by the authors showed particles distinctly visible in the ultramicroscope; differences in ultramicroscopic appearance will be discussed later.

The ultramicroscope used was of the slit type, the source of illumination being a 120-volt direct current arc drawing about 6 amperes. The liquid being examined was contained in a cuvette fitted with quartz windows.

Since the particles of a colloid exhibit Brownian movement, it is apparent that the number of particles in the field of view at any given time is by no means constant. It is also obvious that if there is a large number of particles in the field at once, the diffraction images will overlap to such an extent that the field will show simply a uniform brightening. As the particle count must be made almost instantaneously, it is necessary to dilute the sol to such an extent as to render the individual particles easily distinguishable, and also to such an extent that the number present in the field at any time can be counted at a glance. This number should range from two to five, although it was the experience of the authors that as many as seven or eight particles could be counted at a glance if they were grouped in certain arrangements. The dilution required depended on the concentration of the original sol.

This dilution was accomplished by pipetting 10 cc. of the original sol into a 100 cc. volumetric flask and diluting to the mark with distilled water; after thorough mixing, 10 cc. of this liquid were pipetted into another volumetric flask and water added to make 100 cc. This process was repeated until a sample of the diluted sol, when placed in the cuvette and observed with the ultramicroscope, was found to be suitable for the particle count. Most of the counts were made on dilutions of one to ten thousand or one to twenty thousand of the original sol. Frequently counts were made on different dilutions of the same sol, with results that will be shown later.

The field of view in the ultramicroscope was limited by interposing in the eye-piece of the microscope, a disc of copper foil which had been pierced in the center by a needle. The volume of the field was then determined in the following manner: the eye-piece and objective of the ultramicroscope were transferred to a compound microscope fitted with a micrometer stage. The "effective distance" between rulings on a cross-ruled glass scale contained in the ocular was measured by means of the micrometer apparatus. The copper disc was then superimposed on the cross-ruled scale in the eye-piece, and the "effective diameter" of the hole calculated. With the ocular and objective back on the ultramicroscope, the depth of the field was determined by rotating the slit through an angle of  $90^\circ$ ; what had been depth now became width and was measured with the cross-ruled scale in the eye-piece. (In order to make the path of the beam of light sharply defined, this measurement was taken with a solution of fluorescein in the cuvette.) The field containing the particles to be counted is thus seen to be a cylinder, the diameter and depth of which have been measured.

In order to get a statistical average of the particles in the field at one time, the counts must be made at regular time intervals. This was accomplished by means of a motor-driven disc placed between the slit and the condensing

lens of the microscope; an annular opening near the outer edge of the disc was covered three-fourths of its circumference with red celluloid, the other one-fourth being open to allow the free passage of the beam of white light. By means of such an arrangement the position of the particles could be followed in the field of view—appearing as red points of light—and the count was made when the color changed to white. The disc was rotated at a rate of once in four seconds; the counts were therefore made at regular intervals of four seconds, one second being allowed for the actual count. Although Zsigmondy<sup>1</sup> indicates that 100 to 200 counts should be made on each sol, a larger number of counts was made in this study—usually between 400 and 500. The counts were also made on from three to five different samples of the diluted sol. The total number of particles counted—that is, the sum of the individual counts—divided by the number of counts made, gave the average number of particles in the field at any time.

The number of particles present in unit volume of the original sol was calculated from the average number in the field, the volume of the field, and the dilution. From the analysis of the sol for ferric oxide content, and on the assumption that the density of ferric oxide in the colloidal state is the same as its density in precipitated form, the volume of ferric oxide per unit volume of sol was calculated. The total volume divided by the number of particles gave the volume of each particle. Assuming cubical or spherical particles, the length of cube edge or diameter of sphere readily followed. Since a factor would convert from one to the other, and since this investigation was concerned more vitally with relative rather than absolute sizes, the particles were assumed to be cubes; this resolved the calculations into the following simple formula:

$$\text{Cube edge in cm.} = \sqrt[3]{\frac{\text{vol. field in cc.} \times \text{g. Fe}_2\text{O}_3 \text{ per cc. orig. sol}}{\text{parts. per count} \times \text{dilution} \times \text{density Fe}_2\text{O}_3}}$$

Following is a typical calculation, based on the data from sol No. 35:

Diameter of field	0.03 mm.
Depth of field	0.03 mm.
Volume of field	$2.12 \times 10^{-8}$ cc.
Particles counted	1232
Number of counts	429
Average per count	2.87
Fe <sub>2</sub> O <sub>3</sub>	.00139 g./cc.

In  $2.12 \times 10^{-8}$  cc. there are 2.87 particles, therefore in 1 cc. there are  $2.87 / (2.12 \times 10^{-8}) = 1.354 \times 10^8$  particles. The dilution for count was 10,000; in 1 cc. of the original sol there are  $1.354 \times 10^{12}$  particles. The weight of each particle is  $.00139 / (1.354 \times 10^{12}) = 1.024 \times 10^{-16}$  grams. Assuming the density to be 5.2, the volume of each particle is  $(1.024 \times 10^{-16}) / 5.2 = .197 \times 10^{-16}$  cc. Assuming cubical particles, the length of cube edge will be

<sup>1</sup> Zsigmondy: "Colloids and the Ultramicroscope," 120 (1909).

the cube root of this last number: cube edge =  $\sqrt[3]{.197 \times 10^{-18}} = .58 \times 10^{-6}$  cm. = 58  $\mu\mu$ . With the simplified formula given above, we have:

$$\text{cube edge} = \sqrt[3]{\frac{2.12 \times 10^{-8} \times .00139}{2.87 \times 10,000 \times 5.2}} = 58 \times 10^{-7} = 58 \mu\mu.$$

It is to be remembered that this method gives only the average upper limit for particle size, since any amicroscopic particles would not be counted, although such particles would be included in the analysis of the sol for ferric oxide content.

Wintgen<sup>1</sup> calculated the density of the dispersed phase in ferric oxide hydrosols to range between 4.5 and 4.7; using a mean value of 4.6 for the density—instead of 5.2 as given previously—the particle size would be increased by 3  $\mu\mu$ , or by about 5%.

### Results

The accompanying tables show the results of some of the determinations.

TABLE I  
Preparation with Half-Molar Solution of FeCl<sub>3</sub>

Sol No.	Temp. of prep.	g. Fe <sub>2</sub> O <sub>3</sub> per liter orig. sol	Dilution	Parts. counted	Number of counts	Average	Size in $\mu\mu$
50	106	2.752	10,000	1085	417	2.60	76
49	113	1.663	10,000	1613	470	3.43	58
18	116	0.911	10,000	1075	409	2.63	52
51	120	1.465	10,000	1500	473	3.17	57
52	125	1.287	10,000	1349	524	2.57	59
55	131	1.762	10,000	1381	413	3.34	60
54	139	1.544	10,000	1382	444	3.11	59
56	145	0.218	2,000	765	320	2.39	57
Mean size							60

TABLE II  
Preparation with Molar Solution of FeCl<sub>3</sub>

Sol No.	Temp. of prep.	g. Fe <sub>2</sub> O <sub>3</sub> per liter orig. sol	Dilution	Parts. counted	Number of counts	Average	Size in $\mu\mu$
38	100	2.970	20,000	1172	522	2.25	64
37	106	2.574	20,000	1022	428	2.39	60
27	109	3.881	20,000	2627	576	4.56	56
24	113	1.623	10,000	586	220	2.66	63
10	116	1.564	5,000	1694	463	3.66	70
36C	120	0.713	5,000	1426	436	3.27	56
31	123	3.542	20,000	1802	495	3.64	58
30C	125	3.722	40,000	834	440	1.90	59
32	129	3.287	20,000	1555	501	3.10	60
33	136	3.564	20,000	1209	360	3.36	60
35C	139	1.386	10,000	1232	429	2.87	58
Mean size:							60

<sup>1</sup> Wintgen: Kolloidchem. Beihefte, 7, 251 (1915).

TABLE III  
Preparation with 2-Molar Solution of FeCl<sub>3</sub>

Sol No.	Temp. of prep.	g. Fe <sub>2</sub> O <sub>3</sub> per liter orig. sol	Dilution	Parts. counted	Number of counts	Average	Size in $\mu\mu$
39	101	5.940	20,000	1233	423	2.91	75
21	106	2.495	20,000	1172	429	2.73	57
40	109	3.881	50,000	830	435	1.91	55
41	113	4.433	40,000	1053	494	2.11	60
42	120	5.188	40,000	920	439	2.10	63
13	125	5.069	40,000	1028	426	2.41	60
44	130	2.614	20,000	1116	434	2.57	59
45	136	6.732	40,000	1496	565	2.65	64
46	140	4.396	40,000	1029	455	2.26	58
Mean size:							61

TABLE IV  
Preparation with 4-Molar Solution of FeCl<sub>3</sub>

Sol No.	Temp. of prep.	g. Fe <sub>2</sub> O <sub>3</sub> per liter orig. sol	Dilution	Parts. counted	Number of counts	Average	Size in $\mu\mu$
58	101	5.029	40,000	528	298	1.77	66
59	106	2.653	40,000	503	320	1.57	56
62	123	2.059	20,000	1049	436	2.41	56
Mean size:							59

Table V shows that the particle counts were reproducible at various times and with various dilutions of the sol.

TABLE V

Sol No.	Date of count	Dilution	Size in $\mu\mu$
17	8/1/28	5,000	71
	8/2/28	5,000	71
24	7/23/28	5,000	66
	7/23/28	10,000	63
25	7/20/28	10,000	52
	7/26/28	10,000	54
	2/7/29	10,000	54
27	8/7/28	20,000	56
	8/7/28	40,000	56
57	2/12/29	2,000	51
	2/12/29	4,000	49
62	2/12/29	20,000	57
	2/16/29	20,000	56

Svedberg<sup>1</sup> mentions that the formation of secondary and tertiary particles is favored by high temperature and high concentration of disperse phase. Odén<sup>2</sup> showed that in the case of BaSO<sub>4</sub> sols prepared at 0°, 15° and 100° the degree of dispersion became lower as the temperature increased, "a fact that is very probably due to the increased solubility of the disperse phase at the higher temperature." Bancroft<sup>3</sup> indicates that the "effect of temperature changes on the stability of a colloidal solution may be two-fold. Raising the temperature will increase the peptizing action of the solvent, thereby increasing the stability; but it may decrease the adsorption of the stabilizing ion, thus making the solution less stable. The second factor is the more important with colloidal solutions that are stabilized by an adsorbed ion."

It would seem, therefore, that ferric oxide sols prepared at low temperatures would be more highly disperse than those prepared at higher temperatures. An examination of Tables I to IV shows that such an effect was not observed in this investigation where the temperature ranged from 100° to 145°. In more than 80% of the sols counted the particle size ranged between 54  $\mu\mu$  and 66  $\mu\mu$ , there being no tendency toward larger particles at the higher temperatures. This result was unexpected and rather surprising in view of the fact that the sols prepared at the higher temperatures—above about 125°—always showed some precipitation immediately after their preparation; these sols also showed more or less settling out on standing. The sols prepared at lower temperatures were clear and free from precipitated iron oxide when removed from the autoclave; they gave no precipitation on standing, even after one year.

The ultramicroscopic examination of these sols showed that those prepared at the lower temperatures scattered the light rather feebly, the particles appearing as diffuse diffraction rings; particle counts on such sols were difficult to make. In sols prepared at the higher temperatures, however, the particles were very distinct, appearing as bright points of light on a dark background. Such a behavior would indicate that increasing the hydrolysis temperature increases the refractive index of the disperse phase; this seems to be the only logical conclusion to draw, since the other factors which determine visibility—intensity of illumination, numerical aperture of the instrument, etc.—remain constant. The increase in refractive index of the disperse phase could be accounted for by a (partial) dehydration of the colloidal particles. Work in this laboratory has shown this to be the case, and these studies will be the subject of a later communication.

The highest temperature reported in the tables is 145°. When ferric chloride was introduced at a temperature above 145° no colloid was obtained, the entire quantity of ferric oxide forming a precipitate which settled out in less than one hour. However, samples of a sol prepared by dropping ferric

<sup>1</sup> Svedberg: "The Formation of Colloids," 58 (1921).

<sup>2</sup> Odén: *Arkiv för Kemi*, 7, No. 26 (1920).

<sup>3</sup> Bancroft: "Applied Colloid Chemistry," 300 (1926).

chloride solution into boiling water then dialyzing at 85°–90°, were heated to various temperatures, with the following results: A sample heated to 155° showed no immediate change, with only very slight settling even after thirteen months. A sample heated to 172° was completely precipitated when removed from the autoclave.

The decrease of stability of the sols by increasing temperature of hydrolysis is no doubt largely due to the decreased adsorption of stabilizing ions at the higher temperature. Studies on hydration as a stability factor are now under way in this laboratory.

#### Concentration Effects

Odén<sup>1</sup> showed that with BaSO<sub>4</sub> sols prepared from solutions of Ba(SCN)<sub>2</sub> and (NH<sub>4</sub>)<sub>2</sub>SO<sub>4</sub>, the degree of dispersion always diminished as concentration of reactants decreased. Quite the reverse is true of arsenic sulfide sols prepared by treating As<sub>2</sub>O<sub>3</sub> solutions of varying concentrations with hydrogen sulfide. Linder and Picton<sup>2</sup> assumed this effect, and Börjeson<sup>3</sup> was able to prove it to be actually the case. Thus, 0.0001 normal arsenic oxide solution gave arsenic sulfide particles of radius 11 μμ, while a solution of 0.01 normal arsenic oxide gave particles of radius 39 μμ. That is, a 100-fold increase in concentration of reactant increased the radius of the particles 3½ times. Svedberg<sup>4</sup> (p. 24) prepared ferric oxide sols by the hydrolysis of ferric chloride solutions of concentrations ranging from 1 × 10<sup>-3</sup> to 1 × 10<sup>-7</sup> mols per liter. He showed that as the dilution increased, the light absorbed by the system first increased, passed through a maximum, then decreased—a behavior that indicates decreasing particle size with increasing dilution.

Table VI shows that within the range of concentration used in this study there was no influence of concentration on the size of the particles produced.

TABLE VI

Temp. of prep.	Particle size produced in sols made from 200 cc. of water and 5 cc. of FeCl <sub>3</sub> solution of concentration			
	M/2	M	2M	4M
100	—	64	75	58
106	76	60	57	56
113	58	61	60	—
120	64	56	63	—
125	59	59	60	56
130	60	60	59	—
140	59	59	58	—
Mean size:	63	60	62	57

In each case 5 cc. of FeCl<sub>3</sub> solution of concentration ranging from M/2 to 4M were dropped into 200 cc. of water; this would be equivalent to the hydrolysis of solutions of ferric chloride of concentrations 0.0125 molar to

<sup>1</sup> Odén: Arkiv för Kemi, 7, No. 26 (1920).

<sup>2</sup> Linder and Picton: J. Chem. Soc., 61, 137 (1892); 67, 63 (1895).

<sup>3</sup> Börjeson: Kolloid-Z., 27, 18 (1920).

<sup>4</sup> Svedberg: "Die Existenz der Moleküle" (1912).

0.1 molar. If the effect of concentration in the case of ferric oxide sols were about the same as that observed in the preparation of arsenic sulfide sols, such an eight-fold increase in concentration would increase the particle size by about 1/3; thus, if the 0.0125 molar solution gave particles of size 60  $\mu\mu$ , the 0.1 molar solution would give particles of size 80  $\mu\mu$ . Such an influence was not observed.

#### Summary

1. Ferric oxide sols have been prepared by the hydrolysis of ferric chloride solutions at temperatures between 100° and 145°.
2. Particle size in these sols has been determined by direct particle count, and found to range from 52  $\mu\mu$  to 76  $\mu\mu$ , the mean size being 60  $\mu\mu$ .
3. The particle size is not influenced by the temperature or preparation.
4. The particle size is not influenced by the concentration of reactants.

*Laboratory of General Chemistry,  
University of Wisconsin,  
Madison, Wisconsin.*



## NOTE ON THE CALIBRATION OF CONDUCTIVITY APPARATUS

BY IAN WILLIAM WARK

The standard method of calibration of the bridge (see Findlay's laboratory manual) is rather tedious. For some time past I have used a method which is much less cumbersome; indeed the whole calibration may be performed in under an hour along with the evaluation of the cell constant. The resistance box must be assumed to be correct, or else it should be calibrated previously. This is no disadvantage since a reliable resistance box is essential in conductivity work.

The method recommended is to find the "cell constant," which in the process is to be regarded rather as a calibration constant, for different positions on the bridge, setting the bridge reading successively at 10, 20, 30 . . . 90 and adjusting the resistance to give a minimum sound. The final adjustment is, of course, made on the bridge. The "cell constant" is then plotted against the bridge reading and for any intermediate bridge position the constant to be used is read from the graph.

Some idea of the variation to be expected in a bridge wire of the Kohlrausch drum type may be obtained from Table I. N/10 KCl at 35°, whose conductivity may be taken as  $15.39 \times 10^{-3}$  was used in the calibration.

TABLE I

Resistance in Box	Bridge Reading	Corresponding Cell Resistance	Cell Constant
1000	0.6818	2139	32.92
1500	0.5874	2135	32.85
2000	0.5152	2126	32.72
2500	0.4594	2124	32.68
3000	0.4134	2114	32.53
4000	0.3455	2111	32.48
5000	0.2965	2107	32.42

TABLE II

Resistance in Box	Bridge Reading	Corresponding Cell Resistance	Appropriate Cell Constant	Specific Conductivity
500	0.4286	375.0	32.62	.08700
450	0.4549	375.6	32.66	.08696
400	0.4842	375.5	32.70	.08707
380	0.4972	375.8	32.72	.08707
360	0.5111	376.2	32.73	.08700
350	0.5180	376.2	32.74	.08702
330	0.5328	376.2	32.76	.08707
310	0.5490	377.3	32.78	.08690
270	0.5828	377.2	32.84	.08707
250	0.6014	377.3	32.86	.08712

The results of Table II were obtained for one of the solutions investigated. As is usual, several minima were found corresponding with different resistances in the box. In calculating the specific conductivity, values of the cell constant corresponding to the bridge reading (read from a graph of the results in Table I) have been employed.

The third column shows the variation to be expected if no calibration of the bridge has been performed, the fifth shows how the calibration correction, as applied above, reduced the variation from 1 part in 160 to 1 part in 400.

It is of interest to compare the results for his method of calibration with those obtained by a more usual procedure, where the bridge has been calibrated by the use of two certified resistance boxes. Table III gives such a comparison. The fourth column shows the figures for conductivity by this method, whereas those obtained above (See Table II) are set beside them in the final column.

TABLE III

Resistance in box	Bridge Reading (Corrected)	Corresponding Cell Resistance	Corresponding Specific Conductivity*	Specific conductivity by previous method
500	0.4294	376.2	.08702	.08700
450	0.4555	376.4	.08696	.08696
400	0.4845	376.0	.08707	.08707
380	0.4975	376.2	.08702	.08707
360	0.5111	376.2	.08702	.08700
350	0.5180	376.2	.08702	.08702
330	0.5327	376.2	.08702	.08707
310	0.5486	376.6	.08691	.08690
270	0.5822	476.1	.08704	.08707
250	0.6007	376.0	.08707	.08712

\* Taking cell constant as 32.74, the mean value over a series of readings.

It will be seen that there is little to choose between the two methods with regard to the final results. The major divergences from the mean are evidently due rather to faulty observation than to weakness in calibration methods. The "cell constant" method outlined above has the advantage that it can be applied during the course of necessary procedure, whereas others involve additional work.

I wish to thank Sir David Masson for his interest and advice concerning presentation of the method.

*University of Melbourne.*  
*August 20, 1929.*

## NEW BOOKS

**Colloid Symposium Annual.** Edited by H. B. Weiser. 23 × 16 cm; pp. viii + 300. New York: John Wiley and Sons, 1930. Price: \$3.75. This volume contains the papers presented at the Seventh Symposium on Colloid Chemistry, held at the Johns Hopkins University last year, with F. G. Donnan as the guest of honor. It is printed by John Wiley and Sons, and the title is an improvement over the former one of Colloid Symposium Monograph.

There were twenty-three papers: The Scattering of Light in Sols and Gels, by F. G. Donnan and K. Krishnamurti; The Structure of Gelatin Sols and Gels, by S. E. Sheppard and J. G. McNally; The Measurement of Hydration of Gelatin and Similar Materials and the Relation of Hydration to Swelling, by H. A. Neville and E. R. Theis; The Influence of Adsorption on the Growth of Crystal Surfaces, by K. F. Herzfeld; Crystal Structure and Adsorption from Solution, by W. G. France; Significance of the Electrocapillary Curve, by A. Frumkin; Determination of the Number of Free Electric Charges on Air Bubbles and Oil Droplets dispersed in Water containing a Small Amount of Cetyl Sulfonic Acid, by J. W. McBain and R. C. Williams; The Electrostatics of Flotation, by H. B. Bull; Some Evidence on the Nature of Extra-Molecular Forces, by D. H. Andrews; The Adsorption of Vapors, by W. A. Patrick; The Specific Surface Area of Activated Carbon and Silica, by F. E. Bartell and Ying Fu; Compound Formation with a Volatile Base or Acid, by W. D. Bancroft, C. E. Barnett and B. C. Belden; Nature of Interaction between Hydrous Oxides and Mordant Dyes, by Otto Reinmuth and N. E. Gordon; The Apparent Specific Gravity and Moisture Content of Clay, by F. K. Cameron and R. A. Lineberry; Progress in the Study of Clay Minerals, by E. T. Wherry, C. S. Ross and P. F. Kerr; The Colloidal Nature of Some Finely Divided Natural Phosphates, by K. D. Jacob, W. L. Hill and R. S. Holmes; The Nature of Flow, by E. C. Bingham and Baxter Lowe; The Adsorption of Fats from Volatile Solvents, by H. N. Holmes and C. J. B. Thor; The Chemistry of Bacteria and the Development of a Practical Technique for the Chemical Analysis of Cells, by T. B. Johnson; Human Blood Serum as a Colloidal System, by S. DeW. Ludlum, A. E. Taft, and R. L. Nugent; The Liesegang Phenomenon in Gall Stones, by J. E. Sweet; Studies of the Porous Disc Method of measuring Osmotic Pressures, by J. C. W. Frazer; Adsorption and the Permeability of Membranes, by H. B. Weiser.

"When an agar sol of as low a concentration as 0.5 percent is cooled to about 35°, it sets to a gel. On heating, it liquefies again, but not until a temperature of about 90° is reached. Below this temperature the gel does not liquefy, however long it may be heated. These sols thus show marked hysteresis. This fact enables us to obtain such systems in either a sol or a gel condition at any temperature between 35° and 90°," p. 8.

"It appears justifiable to conclude that the birefringence of these [stretched] gelatin films is caused by the orientation of asymmetrical molecules or micells by the forces set up in drying or stretching the jelly. . . . In terms of this hypothesis, the increase in optical anomaly obtained by stretching and drying gelatin jellies represents a movement in the direction of reversing the process: Collagen > Gelatin. Support for this conception is found from the very important observations of Katz and Gerngross on the X-ray diffraction (powder) spectrum of collagen, gelatin, and strongly stretched gelatin, respectively. Applying the previous observation of Katz that strongly stretched rubber develops new 'crystal interferences,' they investigated other substances which like rubber develop heat on stretching, i.e., show the Joule effect. In all such cases the development of heat may be referred to a recrystallization, or at any rate to the formation of a lattice-like ordering of molecules. Gelatin jellies show this effect, and Katz and Gerngross succeeded in producing very considerable elongations—up to 400 per cent—of glycerin jellies of gelatin; from these the glycerin could be washed out and the tension maintained. Later a technic was developed for producing nearly as large elongations without the use of glycerin.

"Dry unstretched gelatin gives a powder (Debye-Scherrer-Hull) diagram consisting of broad 'amorphous' rings, and a sharp interference ring, similar to a crystalline interference. The inmost broad amorphous ring gives an identify period of 4 Å.U., and is followed outwardly by the sharp ring of period 2.7 Å.U. This is surrounded by a second 'amorphous' band. The sharp band is obtained with pure ash-free gelatin. With the strongly stretched gelatin the bands developed intensity maximum for the direction of stretch, and with very strong gelatin a spectrum was developed *hardly distinguishable from that of collagen*," p. 38.

"The hydration or addition of water to colloids is ascribed by Pauli to the formation of a highly compressed liquid shell about the particles. Such a phenomenon must be accompanied by an increase in density which indicates a compression of the medium (water) or a compression of the particle by its water layer. Hence a contraction of the system gelatin-water must indicate hydration, and measurement of this contraction under varying conditions must give a relative measure of the hydration of the hydrophilic material. From such measurements of this contraction the actual compression may be calculated approximately. Our results indicate that it is of the order of 1000 atmospheres per gram of gelatin in 150 cc. of water at 0° C," p. 43.

"The recent measurements of Neuhaus have proved that the appearance of octahedric forms of rock salt growing in a solution containing urea is due to the fact that, while both the rate of growth of (100) and (111) is diminished, the diminution for (111) (octahedron) is so much greater that the order of the two is reversed," p. 56.

"If Saylor's generalization is correct, then one would expect that all basic dyes forming readily adsorbed cations would produce the same habit in the same crystalline substance. This is not the case when lead nitrate is grown in the presence of bismarck brown and methylene blue. Both of these basic dyes are adsorbed but the former produces octahedra and the latter cubes," p. 86.

"Benzoic acid, benzyl alcohol and benzylamine are all more strongly adsorbed at the mercury-water interface than at the air-water interface; with benzoic acid as with the phenols, the electric effect is negative in the first case and positive in the second case. The specific influence of the mercury surface manifests itself also when halogenated compounds are adsorbed. Many of these give negative values of  $\epsilon$ , which shows that in the surface layer of their solutions the negatively-charged halogen atom is turned outward. The  $\epsilon_{Hg}$  values of substances belonging to this group are negative too, but the lower of the interfacial tension is very much larger when the adsorption occurs at the water-mercury interface. In the case of iodine compounds an enormous lowering of the interfacial tension is observed. This behavior is in complete agreement with the behavior of the iodine ion. If the length of the hydrocarbon chain is increased, the  $\epsilon_{Hg}$  (and  $\epsilon$ ) values become positive, showing that the hydrocarbon chain occupies the space available in the surface layer and pushes the halogen atom out," p. 97.

"We may conclude then that the evidence from the study of atomic and molecular vibration goes to show that chemical forces do not extend much beyond an atomic diameter from the effective surface of an atom or molecule. This view favors the hypothesis of a unimolecular adsorbed layer," p. 128.

Patrick concludes that "the retention of water by silica gel is brought about by the presence of a monomolecular layer which eventually brings about a filling of the capillary spaces under greatly reduced pressures," p. 133. Patrick assumes that Kelvin's equation applies to silica gel, though Kelvin himself repudiates this.

"It has often been considered that the higher the heat of wetting the greater the adsorption. If a liquid with a high heat of wetting is used as a solvent, then less adsorption of the solute will occur from that solution. From the present investigations it is evident that this generalization is not correct. Whether a liquid will be strongly or slightly adsorbed depends on its adhesion tension against the solid. Adhesion tension is the measure of the decrease of free surface energy; and according to Gibbs' theorem of adsorption, that component which lowers the surface tension, that is, the free surface energy, will tend to be positively adsorbed. As shown from the data in this paper, a liquid with low adhesion may have a higher heat of wetting than the one with a greater adhesion tension. This is

because heat of wetting is the measure of the decrease of total surface energy and not the free surface energy; the latter determines the degree of adsorption of the liquid by the solid. If a liquid with a high adhesion tension be used as solvent, the adsorbent will take up considerable amounts of the solvents; hence the adsorption of the solute will be low. If a liquid with high heat of wetting instead of high adhesion tension be used as solvent, a corresponding relationship may not result. Thus it can be shown silica adsorbs better from acetone than from water solutions and carbon adsorbs better from nitrobenzene than from alphabromonaphthalene even though the former two gave the higher heat of wetting," p. 148.

"Plasticity will appear in that region between the point at which there is sufficient moisture to form a film about each particle and the point at which maximum apparent specific gravity can be attained. The necessary condition for plasticity is that the liquid shall readily wet the solid; that is, that there shall be a strong adsorption or adhesion between the liquid and the solid and high surface tension in the liquid interface. Any solute which will increase this surface tension will increase plasticity and *vice versa*. With a high tension in the liquid-solid surface, this surface will not be readily broken and the solid particles will be held together firmly, even though their relative positions be greatly and roughly disturbed. This is what one means by plasticity. Referring to the charts it will be noted that the systems showing marked plasticity, the clays mixed with water or solutions of electrolytes, yielded curves with a steep slope in the region of plasticity. Also, there is a restricted region in which the "balling" phenomenon was conspicuous. There can be no doubt that in these cases there was a strong affinity between the liquid and the solid. But with the pumice, which was composed of particles as small as those of the clay, and in the experiments where organic liquids were mixed with clays, the slope was much less steep and the region of balling more extended, indicating a lesser attraction between liquid and solid," p. 188.

"These clays are found in nature under various conditions, being present, for example, in many soils, but their most interesting occurrence is in the rock known as bentonite. This rock is now recognized to have been produced by the ejection of finely disintegrated lava from volcanoes, and the settling of the particles through the air and through water, yielding stratified beds. Under the influence of substances present in the water, the glass changes into a clay which usually has the composition and a structure just described," p. 192.

"According to Freundlich's interpretation of Traube's work, carbon adsorbs the higher members of a series of fatty acids better from aqueous solutions. Since the higher members of such homologous series are less polar (more like the carbon and less like the polar water), it was predicted by Holmes and McKelvey that the order of adsorption must be reversed when using polar silica to adsorb fatty acids from non-polar toluene. Experiments justified the prediction.

"So in the present research, the nature of the carbon surface and of the silica surface shows differences. Comparing carbon with silica gel, it is seen that the order of adsorption from benzene, toluene, and xylene is reversed. Ether is so polar that it is more adsorbed by polar silica than the fat itself, a result plotted as negative adsorption. Silica adsorbs fat from most of the solvents used three or four times as well as does carbon," p. 216.

"The chemical research work on tuberculosis which has been in progress in the Sterling Chemistry Laboratory at Yale University for the past five years represents a new trend of scientific chemistry, which is not dependent for its success on the artificial creation of new organic compounds. The author refers to the extensive and cooperative investigation of this disease which is being supported by the National Tuberculosis Association. Yale's part in this program of cooperative research is confined to the study of a number of fundamental chemical problems dealing with the constitution of tubercle bacilli, which is the cause of this disease, and the coordination of these findings with the result of analyses of other bacterial cells. This investigation is in reality a pioneer undertaking in a special field of experimental science—'chemical bacteriology'—and is more than a mere application of the technique of organic chemistry to the study of cellular organisms. The art of syn-

thesis plays no important part in the program at present. What we are endeavoring to do is to reveal by chemical method some of the obscure, fundamental chemical changes functioning in the life of a bacterial cell, and if possible to develop practical methods for separating from cells the organic combinations which characterize the biological activity of the respective bacterium.

"In other words, an attempt is being made to develop a new and special technique of bacterial analysis which will lead not only to a better understanding of the constitution of tubercle bacilli and bacteria in general, but also to making available for experimental studies by biologists and clinicians definite and specific cell fractions which hitherto have not been obtainable. The newer problems dealing with the phenomena of immunity, of symbiosis, cell synthesis, cell assimilation, toxin and antitoxin; formation, germicidal action, and anesthesia are dependent for their correct interpretation on a more exact knowledge of the chemistry of the life processes of the growing cell. We are dealing in this work with an aspect of scientific chemistry that is fundamental in nature and having biological significance, and which coordinates with other research activities organized to reveal scientific truths which can be applied for the improvement of man's physical development.

"This cooperative research activity is an excellent illustration of the practicability and productivity of the present-day plan of carrying on research in related fields of science. It is now generally realized that the greatest progress in the solution of broad research problems is made through a joint and coordinated attack by a group of investigators trained in their respective fields of science. Our research on tuberculosis represents one of the newer trends of scientific chemistry and does not depend for its final success on the accomplishments of any one group of specialists," p. 224.

"The chylomicron emulsion is the most important emulsion in existence. Even milk must take second place. It is therefore strange that the writers have been able to find not only no record of investigations directed toward the determination of the stability factors involved, but even no discussion of their possible nature and importance. The colloid chemistry of the chylomicrons is thus a neglected field.

"The major serum lipoids, fats, lecithin, and cholesterol, are present in about equal amounts of the order of 100-250 milligrams each in 100 cc. of fasting serum. It is a most interesting fact, that while lecithin promotes oil-in-water emulsions, cholesterol promotes those of the water-in-oil type. Seifriz emulsified olive oil in water using lecithin as the emulsifying agent and water in olive oil using cholesterol. Corran and Lewis later found a definite antagonism between the two. Starting with lecithin dissolved in water and cholesterol dissolved in olive oil, they found the inversion point to be in the neighborhood of a lecithin-cholesterol ratio of one to one. This is a most striking result because the lecithin-cholesterol ratio in serum has just about this same value. It is suggestive of a rather finely drawn physiological balance. Be that as it may, the possibility remains that lecithin may be important as an emulsifying agent in determining the stability of the chylomicron emulsion. It is also possible that serum protein is an important agent since, for example, Seifriz emulsified olive oil in water with serum albumin just as well as with lecithin," p. 237.

"It seems probable that the gall stone forms as a mass of cholesterol and calcium in the colloid state, each, perhaps, mutually maintaining the other in this state. This plastic mass is moulded into form, which form is determined by the peculiar internal anatomy of the gall bladder, and sometimes, in addition, by the presence of previously formed stones, and then it becomes subject to the action of the bilirubin. The calcium precipitates as a calcium bilirubinate in rhythmic precipitation, forming rings of varied colors, and the consequence of this precipitation is the shifting of the cholesterol from the colloid to the crystalloid state. That the cholesterol passes into the crystalline state after the formation of the rings is indicated by the fact that the crystal beams pass through the rings, as in the crystals from periphery to center," p. 249.

"The results which are given above [on the porous disc method of measuring osmotic pressures] are not to be taken as correct measurements for the osmotic pressure of the solutions mentioned. Two difficulties have stood in the way of obtaining exact data.

One of these was the removal of permanent gases, the other the control of temperature. The first of these difficulties has been overcome. This is not true of the second difficulty. We are quite sure that we do not have the necessary uniformity of temperature in our apparatus and when permanent gases have been removed from the system we have found that a small distillation other than that between solution and solvent has taken place. In order to be sure that the results obtained represent true osmotic pressure it must be shown that solvent distillation takes place only between solution and solvent. The proof of this will be given when with pure solvent replacing the solution in the apparatus described above, the point of zero distillation will correspond to that of zero tension on the solvent beneath the disc," p. 273.

"A membrane which may be regarded as continuous as distinct from porous will be permeable to the solvent and not to the solute if the former dissolves in the membrane and the latter does not. A distinctly porous membrane will be permeable to the solvent and not to the solute if it exhibits such marked negative adsorption that the pore walls are covered with a film of pure solvent and if the pores are sufficiently fine that the adsorbed film fills the pores full. An example of the first class is rubber which is highly permeable to benzene, toluene, and pyridine, which are readily soluble in it, and almost impermeable to water, which is but slightly soluble in it. An example of the second class is copper ferrocyanide which is permeable to water but not to sugar.

"The copper ferrocyanide membrane is impermeable to potassium and sodium ferrocyanide and but slightly permeable, if at all, to hydroferrocyanic acid. This is not due to strong negative adsorption as in the case of sugar solution. On the contrary, the adsorption of ferrocyanides by copper ferrocyanide gel is unusually great. Thus in the case of potassium ferrocyanide the adsorption is so strong that it is practically irreversible between 0 and 0.4 mol of  $K_4Fe(CN)_6$  per mol of  $Cu_2Fe(CN)_6$ . Therein lies the explanation of the impermeability of the membrane to ferrocyanide. The adsorption is so strong that the fixed walls of the pores hold chains of oriented ferrocyanide molecules extending from a monomolecular film on the surface throughout the pore solution. The practically irreversibly adsorbed ferrocyanide is sufficient to saturate the pore water with the salt. Since the solution in the pores is saturated with the adsorbed salt, no more ferrocyanide can enter from the side of the membrane in contact with the solution; and since the adsorption necessary to saturate the pore solution is practically irreversible, ferrocyanide will not pass into water or sugar solution on the opposite side. The result is that the membrane will be impermeable to solute but not to the solvent," p.272.

The Eighth Colloid Symposium will be held at Cornell University June 19-21, 1930.

Wilder D. Bancroft

**Industrial Carbon.** By C. L. Mantell. 22 × 16 cm; pp. xi + 410. New York: D. Van Nostrand Company, 1928. Price: \$4.50. In the preface the author says: "The literature of carbon is widely scattered; in some phases it has been exceedingly sparse, in other plentiful, but at times paradoxical, at times contradictory, incomplete and biased. The literature on the carbon industries is only of recent development. In preparing this book, the author has attempted to cover the technologic applications of elemental carbon, aside from its use as a fuel. . . . The possibility of expansion of the carbon industries is very great, for they are intimately bound up with our highly complex life of the present day."

The subject is presented under the following heads: introduction; diamonds; natural graphite; artificial graphite; graphite crucibles; other graphite refractory products; lubricating graphite; foundry facings; miscellaneous uses of graphite; carbon black; lamp black manufacture; carbonaceous ink pigments; black paint pigments; miscellaneous blacks; charcoal as fuel; gas adsorbent charcoal; bone black; vegetable decolorizing chars; metal adsorbent chars; pharmaceutical charcoal; electrodes; carbon brushes; arc light carbons; carbon specialties; battery and welding carbons; pencils; resistor carbons and carbon refractories; carburizers; physical and chemical properties of carbon.

"It is a decided question as to whether the graphite crucible industry will expand largely in the coming years. The decided tendency as seen some years ago toward the adoption

of the electric furnace with its manifold advantages in various metal industries, will prevent expansion of crucible melting. Crucible steel has almost become entirely a misnomer as almost all so-called crucible steel is made in electric furnaces. There are, however, many industrial applications, usually small scale in size, which will very likely always require crucibles. The pro and con of crucibles versus gas-fired hearth furnaces or electric furnaces has been much discussed in the last decade. The advocates of both sides are equally positive in their conclusions as to the relative merits of either method of operation," p. 57.

"The very low coefficient of friction of graphite is retained under practically all working conditions. It is soft and readily adheres to metallic surfaces, even under light pressures. Its property in the pores of a metal makes it very valuable for lubricating work. The surfaces of bearings when lubricated with graphite become covered with a veneer of the material, which reduces the bearing coefficient of friction to practically that of graphite itself. Graphite is remarkably resistant to most chemical and corrosive actions. The veneer it forms on bearing surfaces thus tends to protect these from the action of corrosive solutions or vapors. This applies particularly to cylinder lubrication where high-pressure steam, oil or gas is used. Oil and grease lubricants under these conditions tend to lose body or to char or vaporize under the action of the heat and the gases to which they are exposed. In heavy bearings, oils and greases show a tendency to squeeze out from between surfaces. As a result the metal parts come in contact and are subjected to wear. Graphite, forming a coating on both metal surfaces, allows a graphite contact instead of a metal contact to be secured.

"For ordinary lubrication in open bearings, slides, gears and similar places, the graphite is commonly mixed with oil or grease. There are a great variety of such compounds on the market, each having according to their manufacture unusual and specific properties. Many of them are designed for work under special conditions such as exposure to salt water, acids or alkalis, in dredges, winches and mining machinery, or at different temperatures where varying degrees of viscosity are required.

"In steam and gas engine and compressor lubrication, dry flake or powdered graphite is often used in addition to oils and greases. In marine engines, cylinder lubrication by graphite is quite advantageous as this method reduces the amount of oil which finds its way into the condensers and boilers. Graphite is largely used in pipe-joint compounds for lubricating and sealing the threads and flanges of various types of piping, as well as various machine parts which are to be more or less permanently in place," p. 60.

"There are four different processes of manufacturing carbon black from natural gas. In comparison, practically all other sources of raw material are commercially unimportant. The four processes are the channel system, the small rotating disk, the roller or rotating cylinder, and the large plate process. These methods differ mainly in the size and shape of the surface upon which the black is collected and the rate of travel of the moving device. There are between 60 and 70 carbon black plants in the country. Fully 80% of the carbon black manufactured today is made by the channel process. Classified according to the quantity of carbon black produced, the order becomes: (1) the channel operation; (2) the small rotating disk; (3) the large plate, and (4) the roller process," p. 71.

"The channel, rotating disk, and large plate methods give carbon black yields per unit volume of gas which are approximately the same. The roller system produces considerably lower yields but the resulting product has special applications. The carbon black yields in the first three processes mentioned vary from figures as low as .78 lbs. carbon black per 1,000 cu. ft. of gas to as high as 1.4 lbs. in some plants. The average, however, is between 1 and 1.1 lbs. carbon black per 1,000 cu. ft. of gas," p. 84.

"Although the carbon black industry owes its early existence to the printing press, its recent growth and present economic status are due to the rubber industry, which in turn is dependent upon the automobile. The most remarkable chapter in the story of carbon black has been its world-wide adoption by the rubber trade during the past decade. Automobile owners of the early days vividly recall how frequently blow outs occurred. After a long search for something which would make tires tougher and more serviceable, the rubber chemist hit upon carbon black. Beginning with one or two of the large American



manufacturers, the use of carbon black in tire tread stocks spread rapidly throughout the entire rubber industry. Approximately 100,000,000 pounds or more per year are now consumed by the rubber trade. Virtually all tire treads are black.

"Carbon black finds its chief use as a filler in rubber because its finely divided state greatly reduces oxidation and increases the tensile strength of the mixture. Carbon black is not considered as indispensable in rubber as in printing ink. In times of high prices it has often been supplanted by zinc oxide or graphite. Zinc oxide, which had early obtained a position as an important filler, became too costly soon after the outbreak of the World War. It was then shown that carbon black could be successfully used as a substitute.

"Carbon black as a rubber filler is now used to the extent of 3 to 20%, according to the purpose for which the rubber is required. On a volume basis, carbon black with the specific gravity of 1.8 costs only 1/3 the price of zinc oxide with the specific gravity of 5.6. In actual practice, however, a greater volume of carbon black is used than of zinc oxide so that the resulting mix contains less rubber per unit volume than the zinc oxide mix," p. 91.

"Typographic printing, lithographic press work, depressed surface, plate or engraving impression are the three main classes of printing. Modern rotary presses require a rapidly drying ink, free flowing to permit high speed of operation. At the same time the ink must have high hiding and covering power. It must make legible impressions instantaneously. Carbon black satisfies all these considerations. Nine pounds of ink containing one pound of carbon black and eight pounds of oil and other materials will print ninety copies of a three hundred page octavo book," p. 106.

"Early in its industrial history, Wallace in 1865 suggested that the active body which affected decolorizing by bone char is a compound of carbon and nitrogen. Patterson isolated a nitrogenous substance from bone char which, according to his data, was even more active as decolorizer than the char from which it was obtained. He stated, therefore, that the active principle of the char was comprised of the nitrogenous bodies present. The work of Horton and his colleagues at the Audubon Sugar School of the University of Louisiana, has definitely shown that bone char owes its power of removing color to the presence of active carbon, and that the nitrogenous material serves as a reserve to supply fresh carbon upon re-ignition. In general, he assumes that the activity of a char from any source is due to the same form of amorphous carbon produced by the low temperature decomposition of vegetable or animal substances. Usually the carbon surface is coated over by a layer of ash or hydrocarbons. The char may be activated by the removal of this film. In the case of bone char, the surface film is definitely soluble in water or dilute acids. Patterson's theory has been completely overthrown and the action of bone char has been satisfactorily explained according to our physical and chemical laws," p. 176.

"The industrial value of carbon might be increased if a carbon were produced which would be active at the permissible pH for the substance to be adsorbed. The electrical properties of carbon can be greatly modified by activation (vide e.g. metal adsorbent chars). Owaga has shown that the isoelectric point of carbon was shifted during the process of activation by heat alone. Perhaps, future research will bring forth for decolorization use a carbon which will be positively charged at all pH's. This would be an excellent addition to our present chars, since most colored impurities met in the industries are negatively charged," p. 233.

"The technical problems involved in the adaptation of charcoal for the removal of gold and silver from cyanide liquors appear to have been met successfully by hydrometallurgical plants in Australia. The use of lump charcoal is not feasible because of the low efficiency and bulk of the material to be smelted. The latest practice involves wet grinding of the char and forming a cake of the ground material on the leaves of a leaf filter. The liquor to be treated is passed through several units in succession, the strongest liquors meeting the partly loaded char and the weakest liquors the fresh char. The cakes are dropped at intervals and reformed, bringing new surfaces into action and materially increasing the capacity of the char. After washing and drying the cakes are burned to remove the carbon and the ash is collected and smelted with a special flux," p. 249.

"The object desired in mixing carbon is to use as little binder as possible and still have the material extrude from the die and not crush or fall to pieces. The condition which is desired in making a carbon mix is to cover each particle of dust with as thin a film of binder as possible, so that when the various particles come in contact they will be well bonded together. Theoretically it is possible to calculate the minimum amount of pitch necessary to accomplish this purpose and several attempts in this direction have been made by the National Carbon Company. The practical difficulties met with in carrying out experiments of this type are practically insurmountable, due to the inability to obtain the size of all the particles. Fortunately, however, an experienced mixing and pressroom foreman who has had the proper training, can gage the amount of binder in the mix he is using so closely that if 1/2 lb. of binder per 100 lb. of mix is removed from the mix, it will cause the product to come from the extrusion press badly cracked," p. 301.

"The tendency in the industry is to make larger and larger electrodes to satisfy the requirements of electric furnaces, the dimensions and capacities of which are ever increasing. In 1922 the largest single electrode made was 20" in diameter, 180" long, and weighed 3,180 pounds. The largest single electrode which the industry has produced was made recently by National Carbon Co. It is 40" in diameter, 110" long and weighs approximately 8,000 pounds. This electrode is shown in Fig. 83. The difficulties involved in its manufacture can only be appreciated by those who have endeavored to make electrodes. If the demand existed, this company is equipped to make electrodes up to 45" in diameter. Certainly, it is a long cry from Bunsen's first little sticks of carbonized wood to the mammoth high-density electrode of the present day! Bunsen's electrodes would float in water; the modern electrode has a density more than 1 1/2 times that of water," p. 342.

"At the present day, only the soft, earthy, or so-called amorphous graphites are used in pencil making. The flake graphites as well as Ceylon plumbago do not possess nearly the same marking power as the earthy kinds, of which the Siberian and Mexican are examples. Mexican graphite forms the bulk of the raw material used in American pencil factories. The Bavarian and Bohemian mineral is also well suited for this purpose. Faber at Stein near Nürnberg in Germany, and Hardmuth at Vienna in Austria, were for years the largest pencil manufacturing concerns in the world. In the early nineties the industry obtained a foothold in America. Within three years the exports of pencils from Germany to the United States dropped off almost one half," p. 384.

*Wilder D. Bancroft*

2 | *The Chemistry of the Colloidal State. By John C. Ware. 23 x 16 cm; pp. vix + 313. New York: John Wiley and Sons, 1930. Price: \$3.75. In the preface, p. ix, the author says that "the purpose of this text is to present the fundamentals of colloid chemistry as they are disclosed by an analysis of the material available at this time and not in accordance with the facts of twenty years ago when the subject was on the threshold of a period of very intensive scientific research."*

The chapters are entitled: the units of a colloidal solution; sedimentation; interfacial phenomena (non-electrical); turbidity and colloidal suspensions; colloidal suspensions and color; motion in colloidal suspensions; the electrical charge of interfacial phenomena; the preparation of substances in the colloidal state; the precipitation of substances in the colloidal state—stabilization or protection of the colloidal state; water in combination—viscosity and plasticity of colloidal suspensions; emulsions; gels; silica gel and its use in adsorption; catalysis by contact agents.

The author objects even to a historical reference to Graham and dialysis at the beginning of the book, because his experiment "unfortunately involves some of the more advanced principles of the subject." In his efforts to make colloids more easy for the beginner, he discusses the ultramicroscope on page eight. On p. 57 he gives the Gibbs adsorption law and tries to apply it, unsuccessfully of course, to adsorption from solution by a solid. We usually represent adsorption in terms of the mass of the adsorbent because we can measure that. The author goes farther, however and says, p. 57, that "the amount adsorbed is not

related to the surface of the solid in contact with the solution, which in this case is 5 cm.,<sup>2</sup> but to the weight of the solid."

On p. 60 the author discusses the use of logarithmic co-ordinates for the adsorption theorem. He says that "when the concentration is zero, the graph cuts the y-axis and the value represented by OS is the constant K in the equation for the isotherm." Since the logarithm for zero is minus infinity, this does not seem very helpful.

On p. 61, the author says that the ratio of the concentrations can be made to equal K by raising one of the concentrations to a suitable power. With this undeniable statement as a starter, he deduces the Freundlich equation, quite forgetting that this is not legitimate unless the ratio of any pair of concentrations can be made equal to K by raising the concentration to the same power. There is no deduction and no proof.

On p. 61 he says that "the formula would indicate that the material of the adsorbent does not affect adsorption." The formula does not indicate anything of the sort. With K and n unpredictable, we can have effects due to the nature of the adsorbent and to its physical structure.

On p. 63 the author says that "it is a well-known fact that slightly colored solutions can be completely decolorized by adsorbents but that deeply colored solutions are but slightly affected irrespective of the amount of adsorbent used." The author should try shaking some dye solutions with charcoal.

On p. 64 the author says that adsorption may be assumed to be complete at the end of twenty minutes. This is only true in case one does one's research work on paper.

On p. 67 the author says that at 100°C coconut charcoal adsorbs, quantitatively, oxygen, nitrogen, and argon from the air. This is of course a typographical error for -100°.

It is rather too bad that we are not told what chemical was added to the gas mask charcoal, p. 67. "It was finally discovered that the material from which the gas-mask charcoal had been made had been soaked in a certain chemical before the charring process, and the presence of the chemical in the resulting charcoal gave it the great efficiency. Whether the presence of the impurity, as it might be termed, increased the adsorptive power by a change in the character of the surface or whether a chemical combination took place between the gas and the included chemical is difficult to determine. The result may have been due to both chemical and physical effects."

It is not true, p. 73, that silver iodide peptized by silver ions consists of AgI.Ag. If one wishes to write (AgI)<sub>x</sub>.Ag, there can be no objection; but it does not take an equivalent amount of silver ions to peptize silver iodide.

On p. 83 is the statement that "the rate of adsorption of a solute from a solution is approximately expressed in the Freundlich isotherm." Most of us use rate as referring to a velocity; but the author uses it in some other sense, which must puzzle the students.

"The value of the nephelometer in research work and in the more general analytical operations is becoming increasingly important. T. F. (?) Richards and others have used the method in the redetermination of certain atomic weights and this shows the extreme accuracy which can be obtained." Actually the nephelometer was used to make corrections for small amounts. No extreme accuracy is obtained.

There is a curious paragraph on p. 144 trying to show a contradiction between osmotic pressures as given by the original van't Hoff hypothesis and as formulated by the Donnan equilibrium. The reviewer was not aware that van't Hoff had ever discussed the osmotic pressure when two solutions having different compositions were separated by a membrane permeable to one ion. Any credit appertaining to this paragraph goes exclusively to the author.

The author quotes, p. 161, the view that a suspension may be positively charged because it adsorbs a polar compound one end on and later may be negatively charged because it adsorbs the same compound the other end on; but he does not explain why the thing reverses.

On p. 237 is the statement that "a very interesting type of emulsion known as a chromatic emulsion exhibits a play of prismatic colors when held in different positions in white light.

These emulsions usually consist of three or more phases and the effect is that of a number of prisms which is produced by combinations of globules in the various aggregates."

Contact catalysis is treated in the last chapter and there is nothing about activated hydrogen being monatomic hydrogen. Altogether, it does not seem to the reviewer that the book is satisfactory either in arrangement or in treatment. *Wilder D. Bancroft*

**Atmospheric Corrosion of Metals.** *Third (Experimental) Report to the Atmospheric Corrosion Research Committee. (British Non-Ferrous Metals Research Association) By J. C. Hudson.* 24 × 15 cm., pp. 75 × 28. London: Faraday Society, 1929. Price: 5 shillings, 6 pence. Whilst the earlier reports of this Committee dealt mainly with laboratory experiments, the present volume contains a record of field tests which have been proceeding concurrently with the laboratory research. Five stations, differing in the nature of their atmosphere, were selected for the erection of the testing frames, and the effect of exposure has been examined by measuring the changes in weight and electrical resistance, and in some instances also of the mechanical strength of the specimens. The influence of rain was eliminated by enclosing the specimens in Stevenson screens. In relatively pure atmospheres the difference between the attack in winter and in summer is not very great; the greater the atmospheric pollution, the greater the seasonal differences in corrosion. None of the alloys examined suffered serious corrosion in the course of a year, the removal of material being so small as to indicate a very long life under such conditions. Alloys which were fully exposed to the action of rain as well as of air were corroded much more rapidly, except in the case of alloys of nickel, which suffer the greatest attack when protected from rain. This is attributed by the author to the effect of the deliquescent coating formed by nickel, which has less effect when the surface is continually washed. It appears that no acceleration of corrosion has been observed during the time of the experiments, but it would be too much to assume that this would continue indefinitely, as experience in towns shows that corrosion to a much greater extent than any recorded here can take place in towns. This is in part due to local concentrations of corrosive liquids, an example being quoted in the discussion of a zinc strip being rapidly eaten away by the water collected on a large sheet of glass above it, the collecting area for acid water being large in comparison with that of the metal. An interesting note by Prof. E. Wilson, showing the effect of corrosion in increasing the corona discharge on high-tension conductors, confirms the results contained in the main report. *C. H. Desch*

**La Diffusion moléculaire de la Lumière.** *Recueil des conférences. Rapports de documentation sur la Physique. By Jean Cabannes.* Vol. 16. 24 × 15 cm; pp. 324. Paris: Les Presses Universitaires de France, 1929. Price: 65 francs. The book begins with a short survey of the subject of light scattering from the early work of Tyndall and the late Lord Rayleigh. Thereafter it divides into two main sections, the first dealing with scattering by gases and vapours and the second by fluids. Two important chapters by Y. Rocard on critical opalescence and a short appendix on the Roman effect complete the volume.

The whole subject of the Molecular Scattering of Light (from the standpoint of classical electromagnetic theory) is dealt with clearly and comprehensively. The mathematical part has been simplified as far as possible, and the selection of technical details and well-chosen tables of results could only have been made by an author who has himself contributed largely to the subject.

Light-scattering gives far more intimate information about a molecule than is obtainable from any other physical measurement such as refractive index, and the experimental difficulties are chiefly chemical and not physical. If the book serves to awaken the interest of some of our younger chemists in this very fruitful line of research, its writing will have been well worth while.

An exhaustive classified bibliography completes this unique work on classical scattering. The appendix on the Raman effect is of necessity rather incomplete and by now considerably out of date, in view of its importance in Band Spectrum work. This, of course, is as yet, only a small part of the whole subject of light-scattering. As the bulk of the recent development work in this branch of optics has been carried out abroad, the appearance of this book is doubly welcome. *W. Ewart Williams*

## THE OPTICAL ROTATION OF MALIC ACID\*

BY WILDER D. BANCROFT AND HERBERT L. DAVIS

Malic acid is regarded as one of the most satisfactory substances to be used in the study of optical activity, and probably only tartaric acid, because of its greater availability, exceeds malic acid in the number of times it has been made the subject of such investigations. The single asymmetric carbon atom of malic acid intrigues with its simplicity and yet the very large amount of work that has been done on this innocent-appearing substance reveals nearly all the optical idiosyncrasies that can be exhibited by the most complex compound. Under the proper conditions the optical rotation of malic acid changes not only in magnitude but even in sign with change in its concentration in various solvents, change in the wave-length of light employed, changes in the temperature, and other changes in its environment such as change in solvent or the addition of foreign substances to its solutions. Such marked changes are not peculiar to malic acid but are certainly not to be

TABLE I

Malic Acid			Sodium Malate		
c	M	(a) <sub>D</sub>	c	M	(a) <sub>D</sub>
63.2	4.71	+1.788°	87.76	4.93	+3.82°
45.68	3.41	+0.600	83.94	4.71	+3.35
36.00	2.68	+0.003	76.08	4.27	+2.37
26.73	1.99	-0.589	65.54	3.68	+0.68
20.92	1.56	-1.050	57.14	3.21	-0.78
15.87	1.18	-1.228	46.78	2.62	-2.54
10.65	0.79	-2.346	36.51	2.05	-4.24
7.52	0.56	-2.479	16.56	0.93	-6.94

expected from a general study of optical activity. In this paper an explanation of these abnormalities is proposed in terms of malic acid and in such a manner that it may be extended to the discussion of analogous compounds, chief among which is tartaric acid.

Of these abnormalities the one most readily studied is the change in rotatory power with dilution of the solutions. It appears to be no mere coincidence that those substances which show marked abnormalities in this property exhibit abnormalities also in other changes of environment and the conclusion seems justified that one explanation may suffice for all these changes of the optical rotatory power under the various conditions.

Numerous investigations have shown the existence and character of the rotation-dilution change of malic acid. One which agrees well with later

\* This work is part of the programme now being carried out at Cornell University under a grant from the Heckscher Foundation for the Advancement of Research established by August Heckscher at Cornell University.

results, including our own, was that of Woringer.<sup>1</sup> His data for the change in the rotatory power of malic acid with change of concentration is given in comparison with the same data for sodium malate according to Thomsen<sup>2</sup> in Table I.

In this table, as elsewhere in this paper,  $c$  refers to the number of grams of solute in 100 cc of solution,  $M$  is the number of mols of solute in 1000 cc of solution, and  $(a)_D$  is the specific rotation calculated from the relation

$$(a)_D = \frac{a_D \times v}{l \times c}$$

where  $a_D$  is the observed rotation of the plane of sodium light,  $l$  is the length of the tube in decimeters, and  $c$  is the number of grams of solute contained in the volume  $v$  of the solution.

Table I shows that ordinary *l*-malic acid is levorotatory in dilute aqueous solution, its specific rotation decreases with increase in concentration, becoming zero for the D light at about 34% acid; more concentrated solutions are dextrorotatory. The rotation of the sodium salt changes similarly, showing however, both in the dilute and in the concentrated solutions a higher numerical value for the rotation.

Various experiments were made by the present authors to verify and extend the existing data for malic acid. The acid used was *l*-malic acid purchased from the Eastman Kodak Co. and used without further purification. In the presence of potassium hydroxide and uranyl nitrate it showed a specific rotation of  $-470^\circ$  under the same conditions as those for which Walden reported  $-465^\circ$ . Later another sample in the presence of ammonium hydroxide and uranyl nitrate gave  $-418^\circ$  as compared with  $-436^\circ$  found by Holmberg. There was a small amount of impurity, apparently calcium malate, insoluble in alcohol and in acetone. Several titrations with alkali indicated a purity of about 99.8%. It melted sharply at  $99^\circ$ - $100^\circ$ .

To check the data from the previous authors for the rotation-dilution phenomenon, some of the *l*-malic acid was made up by weight to a concentrated solution and diluted in stages. The rotations were read in a Franz Schmidt and Haensch polarimeter reading to  $0.01^\circ$ , the solution being contained in a 0.947 decimeter tube at room temperature, which was usually from  $25^\circ$  to  $30^\circ$ . The source of illumination was sodium light from a sodium carbonate bead on a flat coil of platinum wire in the flame of a Fisher burner. The data for the dilution-rotation run on *l*-malic acid are;

Concentration =	63.00	31.50	15.75	7.87
$a_D$	+ 0.61°	- 0.17°	- 0.29°	- 0.16°
$(a)_D$	+ 1.02°	- 0.57°	- 1.94°	- 2.14°

Later in the investigation, when it was thought that the dextrorotation of malic acid might possibly be due to the formation of *d*-malic acid in the solution, some *d*-malic acid was prepared by the method of Holmberg,<sup>3</sup> by

<sup>1</sup> Z. physik. Chem., 36, 336 (1901).

<sup>2</sup> J. prakt. Chem., 143, 753 (1887).

<sup>3</sup> Ber., 60, 2205 (1927).

hydrolyzing sodium *l*-chlorosuccinate by small additions of sodium hydroxide so that the solution was always alkaline. The acid was precipitated as the lead salt and freed by hydrogen sulphide. A rotation-dilution run on this acid gave the following data;

Concentration =	42.96	21.48	10.74	5.37
$\alpha_D$	- 0.16°	+ 0.19°	+ 0.18°	+ 0.10°
$(\alpha)_D$	- 0.39°	+ 0.93°	+ 1.77°	+ 1.96°

The concentration of these solutions was determined by titration with alkali, which seems the preferable method.

These data indicate that both forms of malic acid are affected by the dilution changes, passing through a concentration of inactivity and exhibiting in concentrated solutions rotations opposite in sign to those shown in dilute solutions. The salts behave similarly.

As shown in the data for *l*-malic acid, the dextrorotation continues to increase with concentration, extrapolating to about +5.8° for the pure anhydrous acid. Walden fused some *l*-malic acid and supercooled it to 17°, finding its specific rotation +5.2°, in fair agreement with the extrapolated value. Solubility limits the study of tartaric acid somewhat but the dilute solutions are dextrorotatory, concentrated solutions (supersaturated) are levorotatory, and Biot found that fused plates of *d*-tartaric acid are levorotatory, in complete agreement with the facts for *l*-malic acid.

In contemplation of such data Landolt said,<sup>1</sup> "Such phenomena may perhaps be explained by the assumption that when between the molecules of an active substance (turpentine) other molecules (alcohol) are interspersed, there results a certain modification of the former in such a way that in every molecule the relative separation of the atoms, their arrangement in space, as well as the kind of atomic movement is somewhat altered. This effect will be more marked the greater the number of inactive particles."

The purpose of this paper is to suggest an explanation of this and similar changes in the rotatory power of malic acid. This explanation is that levomalic acid may exist in two tautomeric forms having these formulas, if one wishes to retain normal valences:

Form I (Levo-)

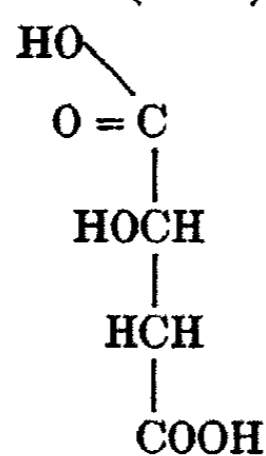

Form II (Dextro-)

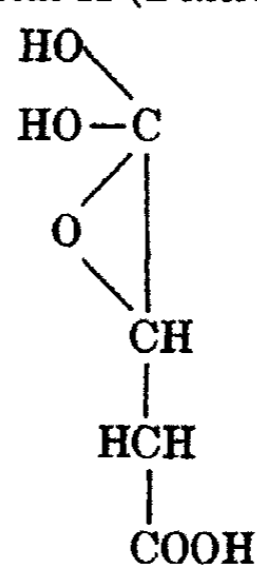

<sup>1</sup>"Das optische Drehungsvermögen," 210 (1898).

For reasons to be elaborated later, form I is considered levo-rotatory and form II dextrorotatory, the two forms having different rotatory dispersions. Form I is the dilute solution form while form II will predominate in concentrated solutions.

We realize that this is by no means a new suggestion. As long ago as 1858 Arndtsen suggested for tartaric acid: "If one should imagine two active substances which do not act chemically on one another, of which one turns the plane of polarization to the right, the other to the left, and, in addition, that the rotation of the first increased (with the refrangibility of the light) more readily than that of the other, it is clear that on mixing these substances in certain proportions, one would have combinations similar to those of tartaric acid." Since the structure and properties of tartaric acid are quite comparable to those of malic acid, any considerations applying to the one should apply at least qualitatively to the other. In a number of papers R. de Malleman<sup>1</sup> has shown the properties of tartaric acid to be similar to those of malic acid and similarly affected by certain changes and has interpreted his results on the assumption that the variations observed are due to the presence in solution of two unlike compounds with inverse rotatory powers. Longchambon<sup>2</sup> has come to a similar conclusion. "Solutions of tartaric acid behave as if they contained two active components, the one dextrorotatory, the other levorotatory and of different dispersive powers; one may suppose in general that the dextrorotatory substance is ordinary tartaric acid, the levorotatory substance may be an isomer, a polymer, an anhydride, an internal ester, etc." He deduces the properties of these two forms from the properties of the tartaric acid.

Among others Astbury and Lowry have contributed to this problem. On the basis of crystallographical measurements, Astbury<sup>3</sup> discussed the crystal structure of tartaric acid. He concluded that the four carbon atoms in the tartaric acid molecule in the crystal are in an irregular spiral formation, as are also the four hydroxyl groups although in an opposite sense. The dextrorotatory power of ordinary tartaric acid is associated with the carbon nucleus spiral which alone under all conditions of solution, dilution, hydration, etc. possesses a stability. Such influences as solution, ionization, and solvation would tend to destroy the levorotatory action of the hydroxyl spiral.

Lowry<sup>4</sup> replies to this that Astbury's explanation cannot be valid for there is no known relation between the degree of polymerization and the rotatory power of an optically active acid. Astbury's idea of the persistence of the hydroxyl linkage between molecules of the acid even in dilute solution is of the nature of polymerization and should show as such. No data for this can be found. Further Lowry shows that the rotatory power of ethyl tartrate cannot be correlated with its degree of polymerization in the various solvents em-

<sup>1</sup> Compt. rend., 173, 474 (1921).

<sup>2</sup> Compt. rend., 178, 951 (1924).

<sup>3</sup> Proc. Roy. Soc., 102A, 506 (1923).

<sup>4</sup> Lowry and Cutter: J. Chem. Soc., 125, 1465 (1924).



ployed. This does not meet Astbury on his own ground but will probably satisfy most people. Lowry and Cutter say: "In our opinion the explanation of this phenomenon is to be sought in some intramolecular change of structure or configuration rather than in the intermolecular action between contiguous molecules." Lowry and Burgess<sup>1</sup> had suggested that the hydroxylic hydrogens of tartaric acid and its esters may be coordinated internally with the carbonyl groups as in the formula below, where the hydrogens in question are shown as bivalent. The corresponding co-ordinated formula for malic acid is also given.

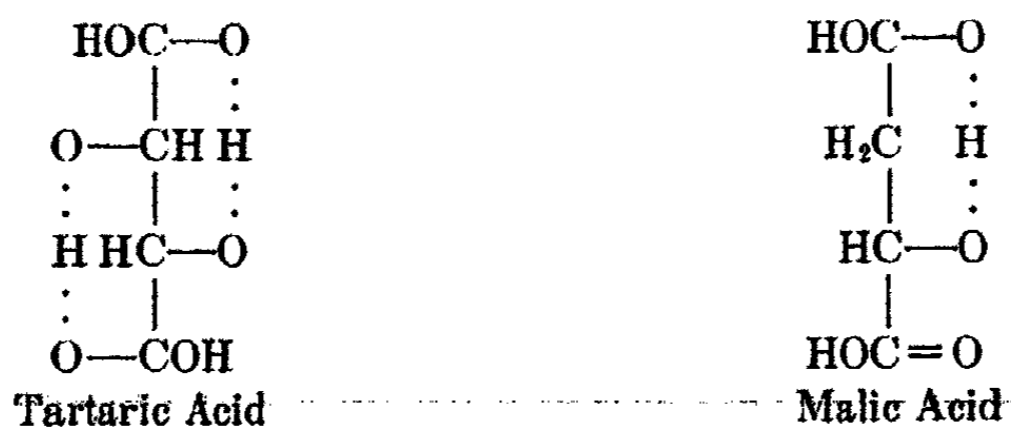

Lowry has certain lines of evidence which he believes indicate the existence of such hydrogen linkage. Most chemists, however, are not yet ready to admit the possibility of the existence of bivalent hydrogen. Since there is no known way of differentiating between the formula proposed by Lowry and the one here offered, this point may well be left open.

Somewhat earlier than those just mentioned was the suggestion of Armstrong and Walker which is quite similar to this one now made. Clough<sup>2</sup> discusses their suggestion in these terms: "Armstrong and Walker suggest four possible formulas for the isodynamic forms of tartaric acid;

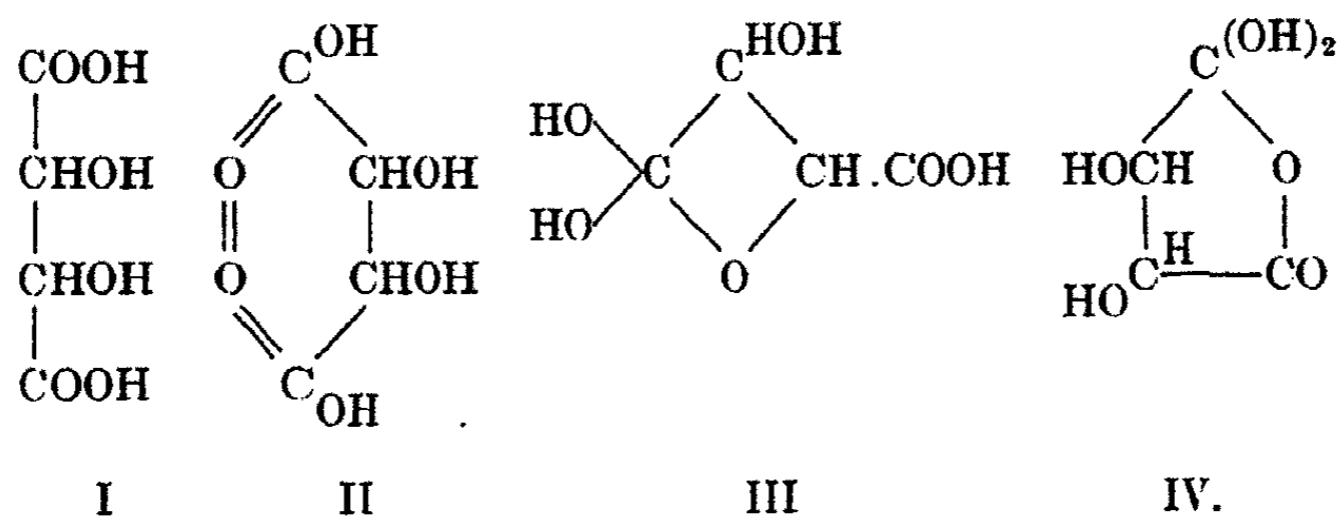

but consider that the forms predominating in aqueous solution are represented by the carboxylic form (I) and the lactonic formula (III). There can be little doubt but that the dextrorotatory form of d-tartaric acid is represented by the carboxylic formula, but there is little evidence in support of the lactonic formula for the levorotatory isodynamic form of d-tartaric acid.

<sup>1</sup> J. Chem. Soc., 123, 2111 (1923).

<sup>2</sup> J. Chem. Soc., 105, 48 (1914).

It seems probable that further work on the rotatory power and rotatory dispersion of similar compounds will throw some light on the constitution of the latter form."

The above references demonstrate that there is fairly general agreement that the properties of tartaric acid (and of malic acid) can be best explained on the assumption of two such components as might have the requisite properties. There is no agreement as to just what these components are nor has either been isolated. The present paper will present some more evidence in favor of such an assumption and will indicate more definitely the structure of the ethylene oxide form as the most probable form present in addition to the normal carboxylic form.

#### Some Evidence for the Explanation now proposed

The theory here suggested will be shown by the formulas;

Form I (Levo)

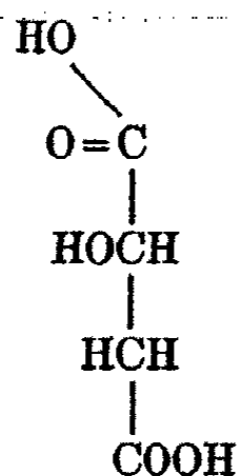

Form II (Dextro)

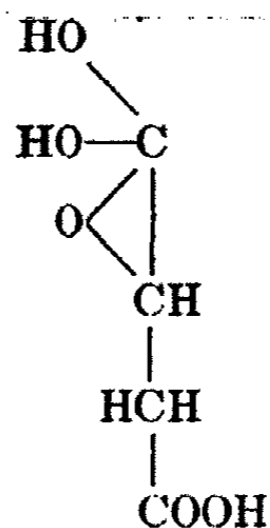

It is suggested that the new dextrorotatory form II arises from form I by migration of the hydrogen of the alcoholic hydroxyl group to form with the ketonic oxygen of the adjacent carboxyl group a second hydroxyl group attached to that carbon atom. That such a migration in similar compounds has been demonstrated before will be shown by some examples.

This form II has two uncommon features. In the first place it contains two hydroxyl groups attached to the original carboxyl carbon atom. And, secondly, there is left a residual ethylene oxide oxygen linkage between the two carbon atoms in question. This might be called an alpha lactone with the water not split off.

This formation of the ring structure is believed to account for the reversal of the sign of rotation. It is well known that the formation of the lactide from lactic acid, while not a lactone in this same sense, does involve a change from a chain to a ring structure and does show the lactide to possess an opposite and remarkably enhanced rotation when compared with the original lactic acid. For many years Holmberg has been developing evidence to show that the hydrolysis of *l*-chlorosuccinic acid to *l*-malic acid involves an intermediate dextrorotatory lactone, the three substances being of the same relative configuration. That such a dextrorotatory lactone of malic acid should on addition of water yield a levorotatory malic acid makes it seem reasonable

that the reverse change might take place causing the *l*-malic acid to produce a ring structure showing dextrorotation.

The evidence in support of the theory just outlined lies first in the fact that a study of malic and tartaric acids and their related compounds reveals that in general when the hydrogen of the alcoholic hydroxyl group is replaced by some alkyl group, the change of rotation on dilution is markedly diminished or entirely eliminated. This is interpreted to mean that the less labile alkyl group is less able to migrate and form the ring structure.

The simplest such derivative of malic acid is, of course, methoxy-succinic acid,<sup>1</sup>  $\text{COOH.CH(OCH}_3\text{).CH}_2\text{.COOH}$ . Solutions of the dextrorotatory acid show remarkably constant rotations in water.

Concentration =	24.65	16.08	8.76
Specific rotation	32.59°	32.79°	32.70°

Solutions in acetone and in ethyl acetate behave similarly as do also the sodium and potassium salts in water, but the calcium and barium salts vary greatly, the barium salt passing through inactivity with dilution. It will be shown later that the calcium and barium salts of malic and of tartaric acids behave quite abnormally. No explanation can yet be offered for this much-studied phenomenon.

Solutions of ethoxysuccinic acid,<sup>2</sup>  $\text{COOH.CH(OC}_2\text{H}_5\text{).CH}_2\text{.COOH}$ , although investigated over a more limited range, show that while the concentration varies from 1.6 to 2.5 grams in 100 cc of solution, the specific rotation varies irregularly between 34.4° and 34.7°. Again the calcium and barium salts are abnormal.

The aqueous solutions of the active propoxysuccinic acid<sup>3</sup>  $\text{COOH.CH(OC}_3\text{H}_7\text{).CH}_2\text{.COOH}$ , also show constant rotations on dilution, and the

Concentration =	3.104	7.76	7.56
Specific rotation	-36.24°	-36.40°	-36.04°

barium salts change much less than in the previous cases.

In addition to these alkyl groups the acid groups may also replace the labile alcoholic hydrogen of malic acid as in acetyl malic acid,  $\text{COOH.CH(O.CO.CH}_3\text{).CH}_2\text{.COOH}$ . Colson<sup>4</sup> showed that the specific rotation of this acid was practically constant, varying only between 10° and 11° while the concentration changed from 0.5 to 20.0 grams in 100 cc. Colson commented especially on this constancy and also upon the fact that the rotation of the salts appeared independent of the base used.

These acids just listed may be considered as derivatives of malic acid in which the labile hydrogen has been replaced by a less labile alkyl or acid group, with consequent permanence of the molecular form. The same condition should result if the hydroxyl group as a whole were replaced. Walden

<sup>1</sup> Purdie and Bolam: *J. Chem. Soc.*, 67, 946 (1895).

<sup>2</sup> Purdie and Williamson: *J. Chem. Soc.*, 67, 944 (1895).

<sup>3</sup> Purdie and Bolam: *J. Chem. Soc.*, 67, 944 (1895).

<sup>4</sup> *Compt. rend.*, 116, 1135 (1893).

showed that *d*-chlorosuccinic acid,  $\text{COOH}\cdot\text{CHCl}\cdot\text{CH}_2\cdot\text{COOH}$ , changed its specific rotation only slightly with dilution.

Concentration =	3.2	6.4	16
Specific rotation	+21.3°	+20.8°	+20.6°

These considerations should apply as well to such derivatives of tartaric acid as to those of malic acid and Purdie and Irvine<sup>1</sup> showed that dimethoxy-succinic acid,  $\text{COOH}\cdot\text{CH}(\text{OCH}_3)\cdot\text{CH}(\text{OCH}_3)\cdot\text{COOH}$ , varied but little with change in concentration.

Concentration =	17.58	8.91	4.45	1.78
Specific rotation	+128.7°	+133.0°	+134.2°	+136.4°

These values do show what appears to be a regular slight variation, which is, however, a smaller fraction of the observed value than is the variation of rotation of malic acid solutions of comparable concentrations, and which shows little chance of changing the sign of rotation as do tartaric and malic in the very strong solutions. The salts are in general more constant than the acid except for the zinc salt where again the influence of the zinc ion is sufficient to make the concentrated solutions levorotatory while the dilute solutions are strongly dextrorotatory.

Purdie<sup>2</sup> summarized the results of an extensive investigation of these substituted acids in these words. "The optical effect of the replacement of the alcoholic hydrogen of tartaric acid by alkyl radicals is of the same nature as that which attends a similar substitution in lactic and malic acids; the sign of rotation, defined in the case of lactic acid as that of its salts, remains unchanged; a striking rise of activity, observable more particularly in the free acids and the ethereal salts, is produced, and the specific rotation of the acids in aqueous solutions of varying concentration becomes more constant. Thus, in passing from tartaric to diethoxysuccinic acid, the molecular rotation of the ethylic salt is raised from +15.8° to +244.3°, and that of the free acid at similar concentration from +20.6° to +136.6°. The ionic rotation, however, does not experience a proportional rise, the result being that, whilst in the case of the three hydroxy acids mentioned the molecular rotations of the alkali salts in dilute solutions greatly exceed those of the free acids, these rotations become nearly equal in the case of the alkoxypropionic compounds, and the order of their value is reversed in the case of the mono- and di-alkyloxysuccinic acids."

This statement of Purdie emphasizes the constancy of the rotations of these compounds with dilution and throws light on another feature of this paper. There is no good reason why the rotation should increase in passing from the free hydroxy acids to their sodium salts and decrease in passing from the free alkyloxysuccinic acids to their salts. If there are no other differences,

<sup>1</sup> J. Chem. Soc., 79, 957 (1901).

<sup>2</sup> Purdie and Pitkeathly: J. Chem. Soc., 75, 160 (1899).

the changes in rotation should be in the same direction in both cases, although quite possibly different in magnitude. The difference here observed must be due to the fact that in the hydroxy acids there is also the effect of the migration of the alcoholic hydrogen which is no longer present in the substituted acids. In these the normal effect of salt formation is manifest in a decrease of rotation while in the hydroxy acids this effect is exceeded by the displacement of the tautomeric equilibrium in favor of the levorotatory form in the case of malic acid. As will be shown later the effect of adding sodium hydroxide to malic acid is to increase the levorotation to the acid salt and then to the neutral salt composition. Further addition of alkali then causes the rotation to decrease as do the first additions to the alkyloxyacids. If we could add alkali to malic acid solely in the normal levorotatory form, its rotation also would decrease with salt formation; the alkyloxyacids can exist practically solely in this form.

The compounds just discussed were all derivatives of malic acid or other  $\alpha$ -hydroxy acids in which the alcoholic hydrogen was replaced by a less labile group. The question may well be asked as to the effect of replacing the hydrogen directly attached to the asymmetric carbon atom by an alkyl group and here again confirmation is found of the theory here proposed. Marckwald and Axelrod<sup>1</sup> prepared  $\alpha$ -methyl malic acid,  $\text{COOH.C}(\text{CH}_3)(\text{OH}).\text{CH}_2.\text{COOH}$ , (*d*-citramalic acid) and resolved it with brucine, finding for the free acid;

Percent acid	74.2	60.0	49.3	35.5	26.5	14.47	7.89	4.04
Specific rotation	$34.67^\circ$	$32.57^\circ$	$31.1^\circ$	$30.8^\circ$	$27.5^\circ$	$27.73^\circ$	$25.25^\circ$	$25.59^\circ$

and for the sodium salt;

Concentration =	20	12	7.2
Specific rotation	$38.00^\circ$	$38.61^\circ$	$38.65^\circ$

These data, then, show very much less alteration of rotatory power than do the corresponding malic acid and sodium malate solutions. In addition to this, the authors point out that there is here no evidence of anomalous dispersion as is shown by the malic acid solutions. The reason for this becomes clear when one considers the well known decrease in activity of the alcohol when passing from a secondary to a tertiary alcohol. This is exactly the change here in that the methyl group attached to the asymmetric carbon atom is thus able to diminish so greatly the tendency of the alcoholic hydrogen to migrate. As will be more fully discussed later the change from the anomalous dispersion of malic acid to the normal dispersion of citramalic acid indicates a loss in complexity; the formation of the dextrorotatory ethylene oxide form is practically completely inhibited.

From time to time various metallic derivatives of the hydroxy acids have been prepared and studied, and the behavior of malic and of tartaric acids in the presence of these metallic compounds is especially complicated. This

<sup>1</sup> Ber., 32, 712 (1899).

effect has been studied for boric acid, tungstates, molybdates, and uranyl salts. The effect of uranyl salts on malic acid was discovered by Walden<sup>1</sup> who showed that the optical activity of malic acid could be increased about two hundred fold by the addition of uranyl salts and alkali. The more recent workers on this subject agree with Walden that the addition agent has to do with the alcoholic hydroxy group of the acid, since practically no effect was observed in the cases of *l*-chlorosuccinic acid, *l*-bromosuccinic acid or *d*-amylacetic acid in alcohol or water, while marked effects were observed in both solvents with malic, tartaric, and quinic acids. An extended study of the "uranato-malate" complex has been made by Andrews<sup>2</sup> who claims to have prepared the ammonium and barium salts of the complex and who ascribes to it the formula;

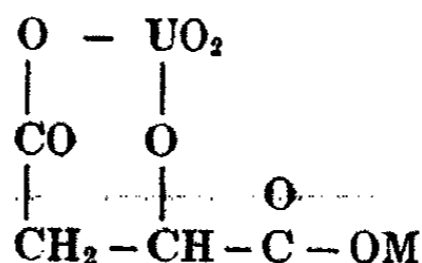

Numerous applications of this enhancement of the rotatory power have been made in the recognition and estimation of small amounts of the feebly rotatory malic acid. Holmberg has standardized his procedure by the use of one mol of uranyl nitrate and four mols of ammonium hydroxide per mol of malic acid. This gives to the malic acid a specific rotation of  $436^\circ$  instead of about  $2^\circ$ . It is of interest in connection with this that the present authors have found that the specific rotation of malic acid in such solutions is independent of the concentration.

A similar result was reported for such metallic derivatives of tartaric acid. Rosenheim and Itzig<sup>3</sup> studied the rotations of potassium, sodium and ammonium salts of mono- and diberyllium tartrates, finding the specific rotations of the aqueous solutions to be but slightly affected by changes in concentration. This stability they attributed to the complex anion in which the alcoholic hydrogens were replaced by a beryllium atom.

It remains to be seen whether subsequent investigation confirms the existence of these metallic derivatives as actual compounds or whether the added substances affect the asymmetry of the optically active molecules without entering into combination with them. If we accept the opinion of these investigators, we may draw the general conclusion that when the hydrogen of the alcoholic hydroxyl groups of malic or of tartaric acids is replaced by alkyl, or acid groups or by metallic atoms, the rotation-dilution changes of the resultant compounds are markedly less than those of the original acids. This demonstrates that the abnormalities of malic acid may be directly attributed to the migration of this hydrogen atom. It may also

<sup>1</sup> Ber., 30, 2889 (1897).

<sup>2</sup> Proc. Iowa Acad. Sci., 32, 299 (1925); Chem. Abs., 21, 712 (1927).

<sup>3</sup> Ber., 32, 3424 (1899).

be indicated that not only does this hydrogen migrate but that it migrates to the adjacent carboxyl group.

Many other acids might have been added to the list given for which the rotation changes with concentration. Lactic acid and mandelic acid are among those showing this property. A recent paper<sup>1</sup> on some derivatives of lactic acid contains this statement: "It was suggested by Wood, Such and Scarf that the complex rotatory dispersion of the esters of lactic acid is due (a) to their persistent low rotatory powers, (b) to the influence of the hydroxyl group attached to the asymmetric carbon atom. The rotatory power of ethyl *d*- $\alpha$ -*p*-toluenesulphonoxy-propionate ( $\text{CH}_3\text{CH}(\text{O}\cdot\text{SO}_2\cdot\text{C}_6\text{H}_4)\cdot\text{COOC}_2\text{H}_5$ ) was determined over a large range of temperature and for light of several wave lengths. Under the experimental conditions tried, it exhibited simple rotatory dispersion in marked contrast to the complex rotatory dispersive power shown by ethyl *d*-lactate. It is remarkable that this complexity of rotatory dispersion of ethyl *d*-lactate should disappear when the *p*-toluenesulphonyl group is substituted for the hydrogen atom of the hydroxyl group attached to the asymmetric carbon atom." This is completely analogous to the behavior of derivatives of malic and tartaric acids which have just been discussed. In general this sensitivity is most marked in those hydroxy acids in which there is a hydroxy group adjacent to the carboxyl group, and this hydroxyl group is attached to the asymmetric carbon atom.

This will be brought out most clearly by a consideration of the  $\alpha$ - and  $\beta$ -hydroxybutyric acids studied by McKenzie.<sup>2</sup> The change for the zinc salt of  $\alpha$ -hydroxybutyric acid is;

$c =$	6.087	8.752	14.12
$(a)_D$	-5.1	-6.0°	-1.0°

On the other hand the rotation of  $\beta$ -hydroxybutyric<sup>3</sup> acid is practically constant.

Solvent	$c$	T	Specific Rotation
Water	3.264	20°	-24.8°
Ethyl alcohol	8.2072	18°	-17.5°
" "	4.994	16°	-17.5°
" "	1.9976	16°	-17.3°

Of the  $\beta$ -hydroxybutyric acid McKenzie says: "The values of the specific rotatory powers of the acid as determined by Magnus-Levy and myself are in excess of those by Minkowski and Kulz and are very little altered by changes in temperature and concentration. The solutions do not exhibit the varying rotations observed with other aliphatic hydroxyacids such as lactic, gluconic, glyceric, and malic which are due to strongly active anhydrides." A little later he adds, "With aliphatic hydroxyacids generally, the molecular rotations of the acids vary considerably with the concentration and values

<sup>1</sup> Kenyon, Philips and Turley: J. Chem. Soc., 127, 409 (1925).

<sup>2</sup> McKenzie and Harden: J. Chem. Soc., 83, 1424 (1903).

<sup>3</sup> McKenzie: J. Chem. Soc., 81, 1402 (1902).

for the dilute aqueous solutions of normal salts are very much higher than those for the free acid. Rotations of  $\beta$ -hydroxybutyric acid and its salts are exceptional in this respect. There is here no indication of the disturbing effect which the hydroxyl group in other cases is known to exert on optical activity."

It is clear therefore, that the migration of the alcoholic hydrogen of malic acid is to the adjacent carboxyl group. Many analogous compounds will be discussed in the next section to show that the resultant lactonic structure is a probable one. Lowry co-ordinated the carboxyls of tartaric acid with the  $\beta$ -hydroxyls; but his formula could have been written equally well with the  $\alpha$ -hydroxyls.

#### Similar Changes of Structure in Other Organic Compounds

The tautomeric change outlined above includes three principal features in the formation of the dextrorotatory form of *l*-malic acid. There are two hydroxyl groups attached to the originally carboxyl carbon atom, there results a residual ethylene oxide linkage between the two adjacent carbon atoms, and, finally, the change produces an alteration of optical activity. Numerous compounds are known to exhibit one or more of these features of structure.

Some compounds are known to have two hydroxyl groups attached to a single carbon atom. One of the more familiar of these is chloral hydrate to which is assigned the formula,  $\text{CCl}_3\text{CH}(\text{OH})_2$ . Another case is the intermediate product formed in the conversion of dimethylallene to methylisopropyl ketone. The intermediate has the formula,  $(\text{CH}_3)_2\text{CH}.\text{C}(\text{OH})_2.\text{CH}_3$ . Holleman<sup>1</sup> says; "Ethers of dihydric alcohols, such as  $\text{CH}_3.\text{CH}(\text{OC}_2\text{H}_5)_2$ , are known, and are termed acetals. Their hydrolysis does not yield  $\text{R}.\text{CH}(\text{OH})_2$ , but an aldehyde. These facts indicate that compounds with more than one hydroxyl group attached to the same carbon atom are unstable, although sometimes it is possible to obtain such derivatives." Glyoxylic acid behaves in some reactions as though its composition were  $\text{CH}(\text{OH})_2.\text{COOH}$ . The constitution of mesoxalic acid is given as  $\text{C}(\text{OH})_2(\text{COOH})_2$ .

Instances of tautomerism involving a mobile hydrogen are too numerous to need further reference. Attention may, however, be called to a few cases in which this migration induces a profound change in the optical activity of the substance. A classical example of this was shown by Lapworth and Hann,<sup>2</sup> indicating such tautomerism as the cause of mutarotation.

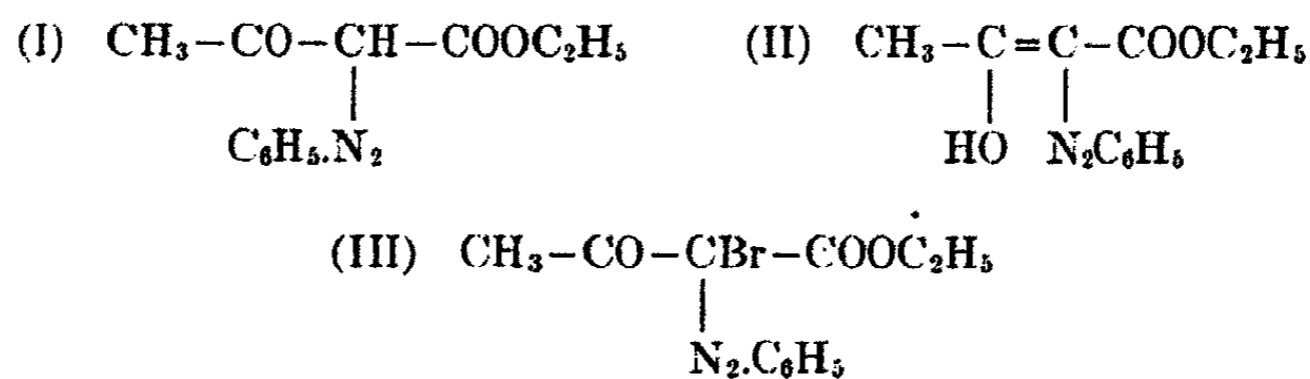

<sup>1</sup> "Textbook of Organic Chemistry", 164 (1925).

<sup>2</sup> J. Chem. Soc., 81, 1491 (1902).



Phenylazoaceto-acetic ester (I) and (II) shows mutarotation but when the  $\alpha$ -hydrogen atom is replaced by bromine, (III), mutarotation is not observed. In this case an atom of hydrogen migrates to an adjacent carbonyl oxygen to form a new hydroxyl group and thus produces a change in the optical rotatory power of the molecule. The lack of such change in the bromine compound is analogous to the constancy of rotation of chlorosuccinic acid as compared with malic acid.

Porter<sup>1</sup> says: "In the case of dextrose, mutarotation may be due to a tautomeric equilibrium between an aldehyde structure and two hemiacetal forms."

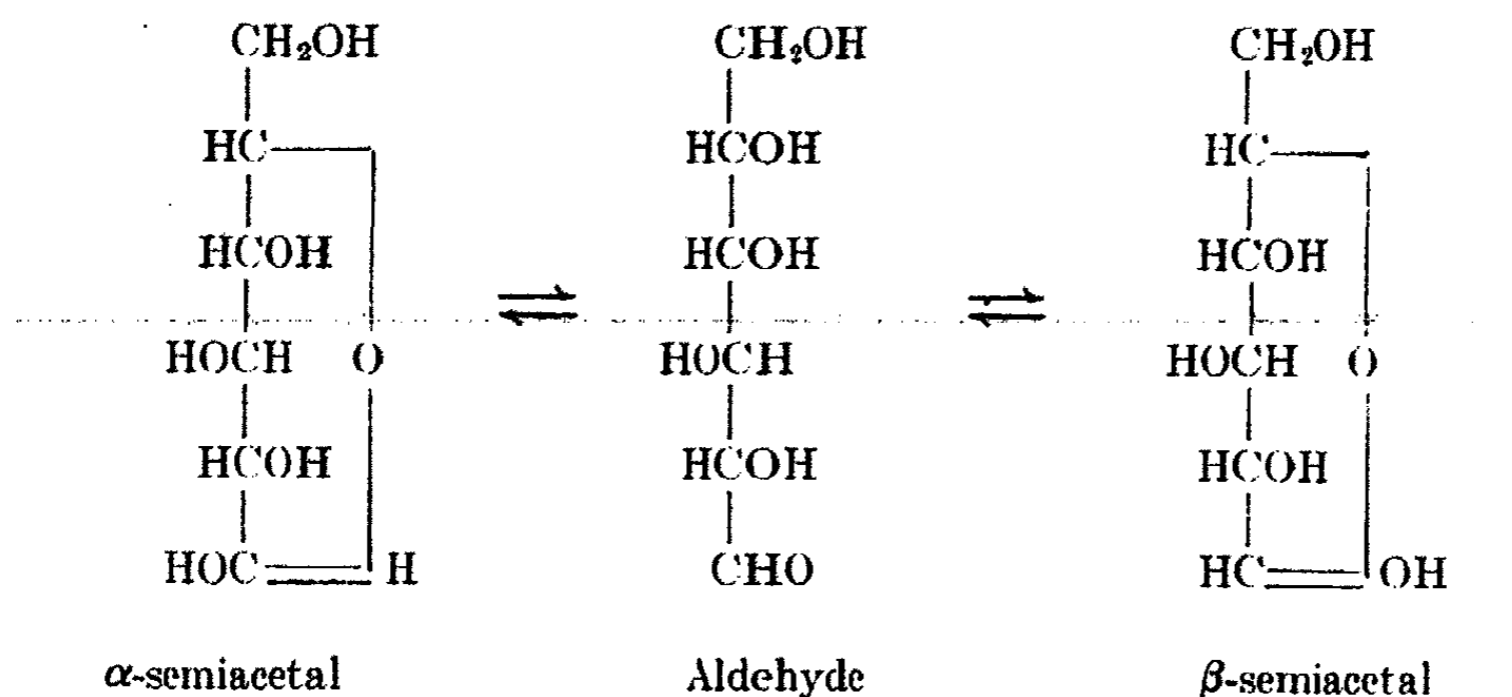

Stewart<sup>2</sup> discusses a number of cases in point. In the topic on racemization (p. 36) is found: "When we take the case of phenylglycollic acid, we find the following process possible:—

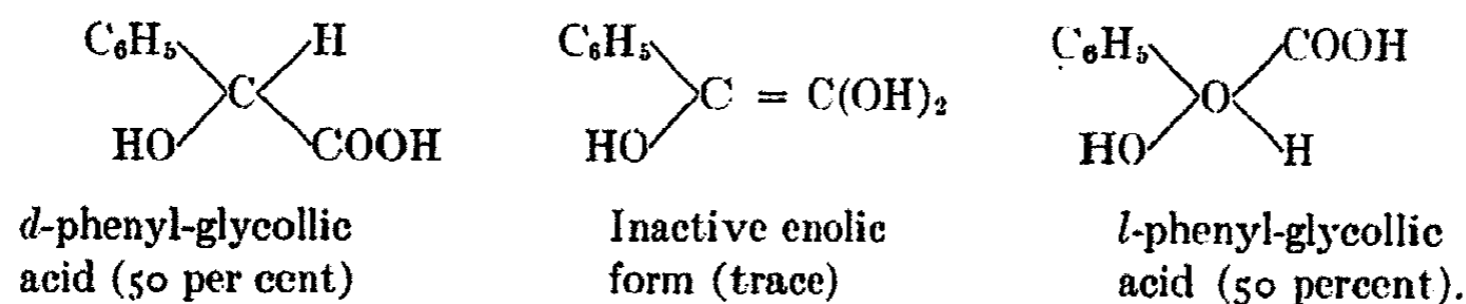

Here through the intermediate enolic form, it is possible for the change from one active form into the other to take place." Here we have a directly attached hydrogen migrating to the adjacent carboxyl group and there forming a second hydroxyl group.

Liebermann<sup>3</sup> has offered an explanation of the transmutation of ethylene isomers along this line, applying it to the change of isocinnamic acid into cinnamic acid, and to the isomers of allo-furfur-acrylic acid. In both cases there is postulated the intermediate formation of a compound in which an oxygen is joined simultaneously to an originally carboxyl carbon and to its adjacent

<sup>1</sup> "Molecular Rearrangements", 145 (1928).

<sup>2</sup> Stewart: "Stereochemistry" (1907).

<sup>3</sup> Ber., 23, 2513 (1890).

carbon atom. "A variation of this is found in the explanation offered by tautomerism, where the unstable enolic form (produced by a wandering of the ethylene hydrogen to the carbonyl of the carboxyl group) is supposed to be the intermediate product:—(Stewart: p. 187).

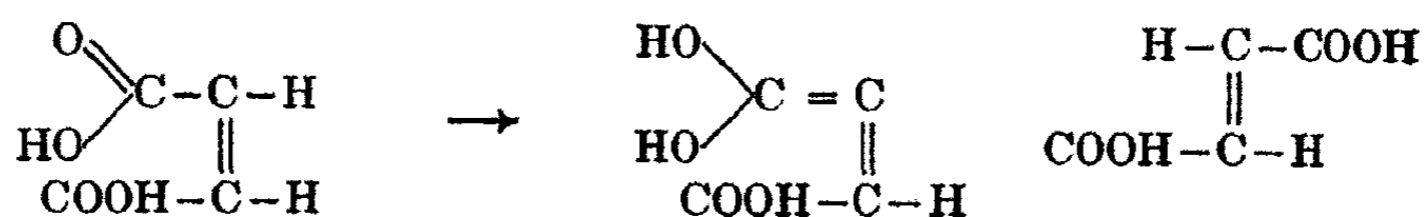

In all these cases is found the migration of the hydrogen atom to a different carbon atom. In some of the compounds this results in two hydroxyl groups attached to the same carbon atoms, and in some to a residual oxygen bond between the two carbon atoms in question, and in some this is associated with a marked change in the optical rotatory power of the substance. There are certain cases in which a migration even more similar to the one here proposed is believed to take place, an originally hydroxyl hydrogen migrates to a keto oxygen to form a new hydroxyl group and leave an ethylene oxide linkage between the adjacent carbon atoms.

Probably the most interesting work in connection with this is the recent study<sup>1</sup> of the isomeric alkyl compounds of cyclohexan-(2)-ol-(1)-one. When this substance is recrystallized from methyl alcohol or distilled under reduced pressure, its melting point is raised from 92°-98° to 130° without change in composition or molecular weight. Its refractive index also changes markedly and isolation of two distinct series of alkyl ethers proves these variations due to the presence of a tautomeric cycloacetal form *l*-hydroxy- $\Delta'$ -cyclohexene oxide (II).

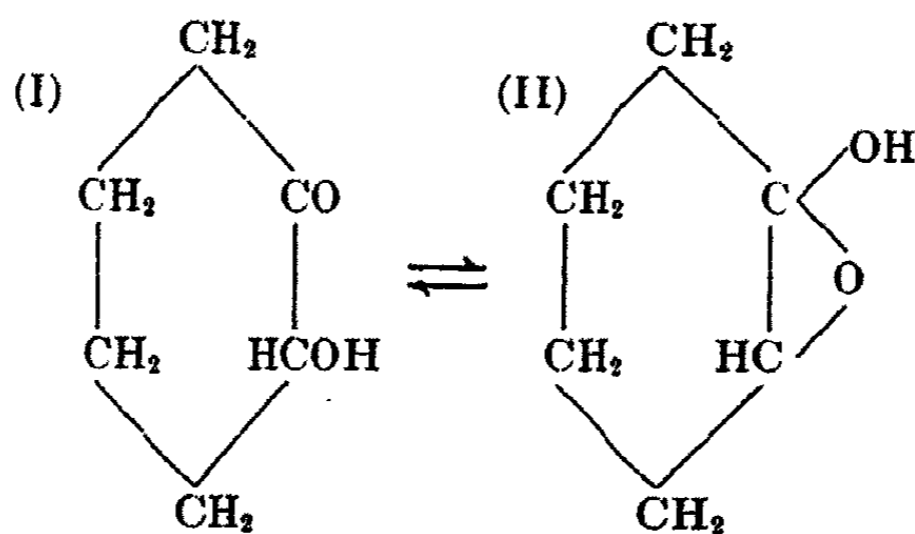

On treating this cyclohexanolone with alcoholic hydrogen chloride, hot, a liquid ethyl compound was obtained with a formula  $\text{C}_6\text{H}_9\text{O}.\text{OC}_2\text{H}_5$ , a molecular weight (by F.Pt.) 142, and forming a phenyl hydrazone of normal composition. This represents form (I). In the cold, the ethyl derivative obtained melts at 137°, has the same composition as before but double the molecular weight, and is not acted on by phenylhydrazine or other hydrazines, showing there is no free carbonyl group. This corresponds to form (II). The similarity between this reaction and the migration herein assumed is striking.

<sup>1</sup> Bergmann and Gierth: Ann., 448, 48 (1926).

We need not, however, rest the case for this tautomeric equilibrium entirely on analogies for we have some direct evidence on these acids themselves. For many years T. M. Lowry has busied himself with the rotatory power of optically active substances and especially with tartaric acid and its derivatives. He has long maintained that the most plausible explanation of the abnormal properties lies in the assumption of the actual presence of two distinct substances. As known examples of this he says:<sup>1</sup> "The way in which a homogeneous solid may give rise to a mixture on fusion or dissolution may be illustrated most readily in the case of the reversible isomeric changes which have been very fully studied under the name of dynamic isomerism. It has been shown, for instance, that nitrocamphor changes over in solution (to the extent of about one-sixth) into an acidic isomeride of opposite rotatory power and probably of unequal dispersive power, thus giving rise to just the right conditions for anomalous rotatory dispersion. . . . In the case of nitrocamphor, isomeric change is sufficiently slow to give rise to the phenomenon of mutarotation, and it was by observations of this kind that the change was first detected."

In the discussion of the main paper quoted above, Lowry added, (p. 137): "Although anomalous rotatory dispersion might be produced in various ways it was probably due in most cases to the presence in the liquid of two or more varieties of optically active molecules. The advocates of this view had been challenged to produce evidence in favor of it. This could easily be done. On the one hand nitrocamphor, which was known to exist in two isodynamic forms, had been found to give rise to anomalous rotatory dispersion when dissolved in acetone. On the other hand ethyl tartrate, the traditional example of anomalous rotatory dispersion, had been proved to be a mixture which could be fractionated by distillation in a vacuum; Mr. Abram had obtained fractions ranging in rotatory power from 5° to 15°. These readings were taken with violet light and with 6 dm. columns of the liquid; the variations with green light were relatively insignificant." It may be regretted that this evidence is not more conclusive.

In the 1914 symposium on optical activity Grossman<sup>2</sup> also presented some evidence on the mutarotation of these compounds. "Walden found that a solution of malic acid in benzyl alcohol was strongly dextrorotatory, but he overlooked the fact that this rotation changes with time and does not reach its constant value until after two days. . . . Benzyl alcohol may be said, therefore to react chemically with malic acid and we may assume the action to be a gradual esterification.

"A further interesting example of mutarotation was found in solutions of malic acid in pyridine. Here one observes a great increase in levorotation, which is probably due to salt formation between malic acid and pyridine; but the formation of the pyridinium salt which dissolves in excess of pyridine occurs not immediately but gradually. The specific rotation after ten min-

<sup>1</sup> Lowry and Dickson: *Trans. Faraday Soc.*, 10, 100 (1914).

<sup>2</sup> *Trans. Faraday Soc.*, 10, 65 (1914).

utes in red light was  $-9.60^\circ$  for a five per cent solution of the acid, the value reaching  $-20.1^\circ$  in the course of two days. Addition of benzene occasioned in this case also a more rapid change of rotation to a constant value.

"Formic acid also produces a remarkable mutarotation both in tartaric and in malic acid. It had already been observed that the esters of these acids dissolved in formic acid changed in rotatory power with time to a constant value, and further, in a former research with Bloch, proof was obtained that sugars exhibit mutarotation in formic acid solution."

#### The Previous Explanations are Inadequate

In the preceding sections some of the anomalous properties of malic acid were mentioned and an explanation of the cause of these abnormalities was advanced on the basis of a tautomeric equilibrium between the ordinary levorotatory form of l-malic acid and a dextrorotary ethylene oxide form predominating in concentrated solutions and in crystals. The evidence for such an assumption was given in terms of the optical rotatory power and the chemical properties of analogous compounds and in the evidence of mutarotation of these compounds themselves. The present section will show that the explanations previously offered by other investigators are inadequate to explain the phenomena and that the ethylene oxide form theory will fit the many facts concerning the properties of malic and tartaric acids.

Of all the explanations hitherto proposed, the one most readily thought of and most often used is that of electrolytic dissociation. A great deal of work on optical activity was being done at about the time that Arrhenius produced his useful theory, and this theory was at once called into service in the field of optical activity. It was shown in numerous cases that the infinitely dilute solutions of various substances containing a common, optically active, ion extrapolated to practically equal values of rotatory power for the ion in question. This was expressed in the Landolt-Oudemans law and was extended by Walden, who showed that the optical rotatory power of a substance containing two optically active ions was an additive function. Much of this work was done on malic and tartaric acids, and, as was to be expected for such weak dibasic acids, the work of Schneider and of Landolt showed that the values for the dilute solutions of the acid salts are intermediate between those of the free acid and of the neutral salts.

#### Specific Rotation for Five Percent Solutions

	Free Acid	Acid sodium salt	Neutral sodium salt
Malic acid	$-3.2^\circ$	$-10.5^\circ$	$-16.0^\circ$
Tartaric acid	$+21.1^\circ$	$+41.2^\circ$	$+59.9^\circ$

These and many other facts fitted into the ionization theory, and it was perfectly easy to point out that, since all the very dilute solutions of malates, including that of malic acid itself, were levorotatory, this must be the rotation of the malate ion. Logical extension required that the malic acid molecule must be dextrorotatory since concentrated solutions of malic acid show

dextrorotation. According to this, then, the rotation-dilution change of malic acid is caused by the ionization of the weak malic acid. For the dilute solutions it will be apparent that the acid salts will necessarily be directly comparable with the free acids since in the free acids the secondary ionization will be quite beyond any recognition by the polarimeter.

These data could be explained on the basis of ionization; but there are insuperable difficulties. Nasini and Gennari<sup>1</sup> made a most extensive study of malic acid and its rotation as this was affected by changes in concentration, temperature, and wave-length of light employed. They pointed out that since malic acid is a weak acid (its ionization constant is about midway between those of acetic and of tartaric acids), in the most concentrated solutions for which the abnormalities are largest, there must be few ions when one considers that a 0.4% solution is only about 10% ionized. This means that those solutions for which one should take ionization into account are so dilute that they can no longer be investigated in the polarimeter. Ostwald reported that tartaric acid is not appreciably dissociated until the solution becomes so dilute that polarimeter readings are no longer possible. As indicated above, this theory provides that the ion of malic acid be levorotatory and the undissociated acid or salt dextrorotatory; but this contradicts the behavior in organic solvents in which (and this is especially true of propyl alcohol) one cannot assume electrolytic dissociation and in which, nevertheless, is found strong levorotation. The possibility that the ion possesses a very large levorotation and that consequently but few ions suffice to create the abnormalities is without foundation, for many workers confirm the findings earlier reported here that the ion cannot extrapolate to more than  $-9^\circ$  or  $-10^\circ$ .

Nasini and Gennari reported also that new studies by Carrara had shown that, while methyl alcohol and acetone possess dissociating power not much below that of water, ionization in ethyl alcohol is much less, and there is practically no dissociation in propyl alcohol. Nevertheless these solvents all yield with malic acid, solutions possessing greater levorotatory power than is found in aqueous malic acid solutions or even aqueous sodium malate which might be regarded as a limit. In order to retain the ionization theory we should need to postulate greater than 100% ionization in these organic solvents.

If the malic acid were behaving like an ordinary weak acid and if the change in ionization were actually parallel to the change in optical activity, the latter should change sharply from a large negative value in dilute solutions to a nearly constant rotation in moderately concentrated solutions. This is not the case; the rotation-dilution curves are nearly straight lines and show no tendency to approach any value as a limit. Some examples will be given to illustrate that the rotation-dilution curves in non-aqueous solvents are of the same type (practically straight lines) as those previously reported for malic acid and sodium malate in water.

<sup>1</sup> Z. physik. Chem., 19, 113 (1896).

The first of these is malic acid in absolute alcohol. Some of the acid was dissolved in alcohol, filtered clear and diluted, the concentration at each stage being determined by titration with alkali. The data represent two separate runs.

**Rotation-Dilution Change of *l*-Malic Acid in Alcohol**

Concentration	48.84	25.1	24.4	12.8	12.2	6.4	6.1	3.2
Specific rotation	-1.17°	-4.33°	-4.37°	-6.11°	-6.06°	-7.10°	-7.78°	-7.92°

There was no appreciable esterification in these solutions as there is no catalyst present, heating was avoided as far as possible, and they were examined very soon after preparation. The neutralized solutions after standing over night were again made alkaline to phenolphthalein by a single drop of alkali. These points, except for that of the most dilute solution, lie on a nearly straight line, the most dilute solution exhibiting larger levorotation than a linear relation requires. This is exactly analogous to the relation in aqueous solution but comparison with Table I will show the alcoholic solutions to be uniformly more levorotatory than corresponding aqueous solutions. This could not be true if it were a case of ionization.

A similar experiment was made with *l*-malic acid in acetone. The acid was dissolved in a large quantity of acetone, the precipitate of calcium malate filtered off and the filtrate concentrated in a vacuum. This solution was then diluted in steps and the concentration determined by titration with alkali. This was not perfectly satisfactory in this case because of the fading end-point with phenolphthalein. This can affect the results but slightly.

**Rotation-Dilution Change of *l*-Malic Acid in Acetone**

Concentration =	88.8	45.8	24.1	12.1	6.11
Specific rotation	-0.44°	-1.46°	-1.94°	-2.14°	-2.31°

Again the data lie on a straight line which in the more concentrated solutions lies below (solutions are more levorotatory) the line for aqueous malic acid. The more dilute acetone solutions are slightly less levorotatory than the aqueous solutions. The conclusion may be drawn that acetone and alcohol affect malic acid qualitatively as does water; in no case is there evidence for the ionization of a weak acid. In addition to this, these non-aqueous solvents appear to favor the formation of the normal levorotatory form of malic acid.

In order to confirm this conclusion, diethyl malate was prepared from *l*-malic acid and an alcoholic solution of hydrogen chloride. In order to avoid loss of optical activity, the reaction was not heated but was permitted to proceed at room temperature for several days. The alcohol and hydrogen chloride were distilled off in a vacuum at from 45° to 50°. Samples were weighed out and hydrolyzed with excess alkali.

No. 1 Calculated volume of alkali 44.25 cc.; required 44.0 cc.  
 No. 2 " " " " 42.4 cc; " 42.5 cc.

The ester thus prepared was found to have a specific gravity 1.1537 making it 6.08 molar. Portions of the pure ester were weighed out and dissolved in alcohol, giving the following dilution data, where  $M$  is the molality of the solutions and  $(M)_D$  is the molecular rotation.

#### Diethyl Malate in Absolute Alcohol

$M$	6.08 M	2.5 M	$M$	0.5 M	0.25 M
$(M)_D$	$-14.34^\circ$	$-18.77^\circ$	$-20.17^\circ$	$-20.70^\circ$	$-21.54^\circ$

Probably no one would claim any ionization for ethyl malate in alcohol and yet these data show that the rotation-dilution change is closely analogous to that of malic acid in water. Again the concentrated solutions lie nearly on a straight line and the most dilute solution exhibits a greater levorotation than the linear relation provides. Other solvents similarly increase the optical rotatory power of ethyl malate. A half-molar solution of the ester in benzene showed,  $(M)_D = -15.63^\circ$ , and in acetone  $(M)_D = -24.72^\circ$ .

Further evidence for the inadequacy of the ionization theory here will be found in a study of the effect of added electrolytes on solutions of malic acid and the malates. If a strong acid such as HCl be added to a weak acid such as malic acid, the first effect will be to repress the ionization of the weak acid. That this is true in the case of malic acid will be shown in the table below where are given the specific rotations of malic acid in various concentrations in the presence of varying amounts of hydrochloric acid.

#### Effect of HCl on *l*-Malic Acid in Aqueous Solution

Malic acid conc.	0.25 M	0.5 M	$M$	2 M
In water only	$-3.15^\circ$	$-2.36^\circ$	$-1.65^\circ$	$-0.86^\circ$
In 0.1N HCl	$-2.20$	$-1.89^\circ$	$-1.65^\circ$	$-0.83^\circ$
0.5N HCl	$-1.57^\circ$	—	—	—
1.0N HCl	$-1.26^\circ$	—	—	—
5 N HCl	$+2.10^\circ$	$+2.52^\circ$	$+4.10^\circ$	$+4.65^\circ$
10N HCl	$+5.67^\circ$	$+5.98^\circ$	$+6.93^\circ$	$(+7.15^\circ)$

These solutions were prepared by weighing the required amount of *l*-malic acid, adding the calculated amount of strong HCl and diluting to the required volume. Thus the solution  $(a)_D = -1.89^\circ$  was half molar with respect to malic acid and tenth normal with respect to hydrochloric acid, and gave a reading of  $a_D = -0.12^\circ$  in a 0.947 dm tube. The most strongly dextrorotatory value is extrapolated from a solution 8N with HCl.

There are obviously two effects here tending in the same direction. The first is an ordinary repression of the ionization of the malic acid, producing the dextrorotatory form of the molecular acid, and shown in the dilute solutions on addition of small amounts of hydrochloric acid. The ionization constant of malic acid is given as  $4 \times 10^{-4}$  which means that the 0.5M solution will be between 1 and 2% ionized. For solutions more concentrated than this, the 0.1N HCl has no effect since there is practically no dissociation

to be repressed and the acid is not strong enough to have any marked effect on the second change. This second change is the effect of the strong mineral acid to favor the formation of the undissociated dextrorotatory form of malic acid. A little of the mineral acid represses the ionization to the dextro form; a large amount of acid displaces the equilibrium far in favor of the dextro form. This is the effect early reported by Schneider<sup>1</sup> who observed that this effect was about ten-fold greater when sulphuric acid was used than when acetic acid was added. The ionization theory is quite inadequate to explain such large effects. It may be added that strong sodium hydroxide solutions likewise have a dextrorotatory effect on sodium malate. It is well known that boiling malic acid in the presence of strong acid or alkali dehydrates it to fumaric acid,  $\text{COOH}\cdot\text{CH}:\text{CH}\cdot\text{COOH}$ , but this would result only in a loss of activity and not in a gain of opposite rotation.

This effect of hydrochloric acid is not restricted to aqueous solutions but is found also in alcoholic solutions. Thus 0.5M solutions of malic acid with increasing amounts of acid showed the following rotations in absolute alcohol.

#### Effect of HCl on 0.5 M Malic Acid in Alcohol

Normality of HCl	1	1.8	4	7N
(a) <sub>D</sub>	-12.76°	-11.82°	-6.46°	-0.79°
(M) <sub>D</sub>	-17.10°	-15.85°	-8.66°	-1.05°

The effect of concentration of the malic acid is not so marked, as will be seen in the following solutions which are all 1.8N with respect to hydrochloric acid.

#### Effect of Concn. of Malic Acid in 1.8 N HCl Alcoholic Solutions

Concentration of malic acid	0.25M	0.5M	M
(a) <sub>D</sub>	-12.6°	-11.82°	-10.87°
(M) <sub>D</sub>	-16.89°	-15.85°	-14.67°

In all probability there was some esterification in these solutions but they were all run promptly after being made so that the effect is negligible. They demonstrate that, although alcohol favors the levorotatory form, in alcohol, as in water increasing concentration of malic acid shifts the equilibrium in favor of the dextrorotatory form and that increasing concentrations of hydrogen chloride have the same effect. The levorotatory effect of the alcohol makes it more difficult there to get dextrorotatory solutions but in one case 9N HCl caused 0.25 M malic acid in alcohol to show a rotation (M)<sub>D</sub> = +5.06° which is about 3° lower than a similar aqueous solution would have given.

The second effect is the only one to be considered if one uses ethyl malate in alcohol containing increasing amounts of hydrogen chloride.

#### Effect of HCl on 0.5 M Diethyl Malate in Alcohol

Concentration of HCl	0	N	4 N
(M) <sub>D</sub>	-20.70°	-18.38°	-9.50°

<sup>1</sup> Ann., 207, 257 (1881).



The hydrogen chloride can not be repressing ionization for there is none. The effect of HCl on diethyl malate in alcohol is of the same nature as that on malic acid in aqueous solution. In both solvents addition of HCl favors the formation of the dextrorotatory, ethylene oxide, form.

As hydrogen chloride affects profoundly the structure and rotation of malic acid in solution, so also do various salts affect the malates. This will be shown by the data on the following solutions made by weighing out 0.879 g. *L*-malic acid, neutralizing this with NaOH and adding the calculated amounts of the respective salts. The solutions were all, therefore, 0.262 M with respect to sodium malate and of various normalities with respect to the salts.

Effect of Salts on Sodium Malate

	(a) <sub>D</sub>	(M) <sub>D</sub>		(a) <sub>D</sub>	(M) <sub>D</sub>
Sodium malate	-8.82°	-15.70°			
N NaCl	-7.69°	-13.69°	N NaBr	-7.46°	-13.28°
3N NaCl	-5.88°	-10.46°	3N NaBr	-5.65°	-10.06°
5N NaCl	-3.39°	-6.04°	5N NaBr	-3.62°	-6.48°

In this table the effect of each mol of salt is to decrease the specific rotation of sodium malate about one degree. A very extensive investigation of this effect was made by Stubbs<sup>1</sup> who found that the effect of such salts (in more dilute solutions) was an additive one which could be attributed to the ions separately, the positive and the negative ions falling into series of similar nature to other series known. In order of effectiveness these were; (best) Cs, Rb, K, Na, NH<sub>4</sub>, Li (least), and (best) I, Br, Cl, NO<sub>3</sub>, 1/2SO<sub>4</sub> (least), with calcium and barium showing very large effects and zinc and mercury anomalous effects. These effects, Stubbs believed could only be explained by some power of the inactive electrolytes of influencing the asymmetry of the active molecules without entering into combination with them. It seemed probable to him that the mode of influence might be connected with the sensitiveness of the hydroxyl group of malic acid.

More recently Darmois<sup>2</sup> has made a similar study of the effect of salts on tartaric acid and has reviewed several hypotheses regarding the cause of this influence returning finally to the theory of two forms of tartaric acid which can not at present be determined.

Markedly abnormal is the behavior of the bivalent metallic salts, especially barium and calcium. The chlorides and nitrates of these metals produce about three times the effect of an equivalent amount of the univalent salt. Stubbs comments: "It is very significant that, as appears from the conductivity tables, the dissociation of barium nitrate in aqueous solutions is abnormally low; for, whilst barium and calcium chlorides show practically equal degrees of dissociation in N/2 solutions, that of barium nitrate is only about five-sixths that of calcium nitrate. A connexion thus appears

<sup>1</sup> J. Chem. Soc., 99, 2265 (1911).

<sup>2</sup> Ann. Phys., 10, 70 (1928).

to exist between the degree of dissociation of a salt and its influence on the rotation of malic acid.

"The most remarkable fact shown by Table IV is the great influence exerted by salts of barium and calcium, especially when it is remembered that in equal equivalent concentrations there is only half an atom of these elements present to one atom of the alkalis."

A table of various bivalent salts leads him to the further conclusion: "It follows that the large influence of barium and calcium salts is not merely dependent on the valency of the metal."

In general the bivalent salts behave differently from the univalent salts. "A striking illustration is the case of zinc sulphate, where the effect of  $n = 1/4$  (a twenty per cent solution of *l*-malic acid containing  $1/4$  equivalent of salt) is actually zero, that when  $n = 1$  being more than a degree. It thus appears that the first addition of zinc sulphate produces a negative effect, making the solution more levo; and that, as further quantities are added, the influence attains a negative maximum, passes through zero, and becomes positive. The case of mercuric nitrate, if comparable, is more remarkable still. The figures (for  $n = 1/4$ ,  $\Delta = -3.36^\circ$ , and for  $n = 1$ ,  $\Delta = -3.58^\circ$ ,  $\Delta$  being the change in rotation produced) suggest that the initial large negative influence reaches a maximum between the concentrations studied, and that further additions of salt would probably influence the rotation on a dextro-sense."

Schneider had shown that while inactivity on dilution in the case of the alkali malates entered in fairly concentrated solutions containing from 25 to 60% of the salts, the data for barium malate are quite different.

Percent barium malate	1.96	4.99	8.50	9.38%
Specific rotation	-2.58°	+4.69°	+8.05°	+8.18°

This would indicate an inactive solution contained about 3% of barium malate. Hence calcium and barium salts as added to malic acid seem markedly to influence the formation of the dextro (the concentrated solution) form and the same thing is true of the barium malate as such.

A similar phenomenon is reported by de Malleman<sup>1</sup> for tartaric acid. Additions of concentrated solutions of calcium chloride affect enormously the rotation of *d*-tartaric acid, diethyl tartrate, (in water and in alcohol) and sodium hydrogen tartrate, making each solution strongly levorotatory, or favoring the concentrated solution form, as it should be remembered that while dilute solutions of tartaric acid are dextrorotatory the ethylene oxide form of this acid will be levorotatory.

In addition to the changes listed above, malic acid shows several other abnormalities. With rise in temperature a levorotatory solution of malic acid becomes more strongly so, while a dextrorotatory solution may show levorotation at higher temperatures. As was pointed out above, the same is true of the supercooled solid. It is clear that rise in temperature favors the

<sup>1</sup> Compt. rend., 173, 474 (1921).

formation of the levorotatory form. This form corresponds to the keto form in the usual keto-enol tautomerism and rise in temperature usually favors this form. The same situation (with signs reversed) prevails in tartaric acid. Increase in temperature favors the formation of the dilute-solution normal form in both cases. Again this effect is much too large to be explained on the dissociation hypothesis. It has, therefore, been shown that although malic acid is dissociated as a weak acid this ionization is quite inadequate to explain the numerous abnormalities in the optical rotations of malic acid and its derivatives. More attention has been given to this explanation of the phenomena than will be given to the remaining explanations because of the apparent simplicity of this one and the number of times it has been mentioned in the literature.

Another popular explanation has been founded on the assumption that in concentrated solutions there are formed dextrorotatory semi-crystalline aggregates of the malic acid molecules. Landolt showed and Lowry<sup>1</sup> has more recently demonstrated that there is no direct relation between the degree of polymerization of a solute and its optical rotatory power. The work of Lowry indicates that there are solutions of ethyl tartrate in various solvents in which the ester is polymerized increasingly with concentration, and the specific rotation changes but little with change in concentration; while in other solvents freezing-point measurements indicate that there is practically no polymerization, and the rotations change markedly with dilution. Lowry and Cutter believe their facts are in accord with three propositions: "(1) the ester exists in isomeric dextro and levoforms; (2) the levo form tends to be produced in solvents which favor polymerization; (3) this polymerization, however, usually produces an increased dextrorotation or a decreased levorotation." It is clear, then, that for ethyl tartrate polymerization is inadequate, all varieties of relationships being known.

The behavior of malic acid is similar. The fact that malic acid crystallizes with difficulties under the best conditions indicates a probable absence of crystal aggregates. Raoult showed that dilute aqueous solutions of malic acid gave a normal lowering of the freezing-point. In addition to this Nasini and Gennari showed that the freezing point depression of solutions containing up to 24.5 grams of malic acid in 100 grams of water was still normal and indicated no sign of polymerization. But there always exists some suspicion of molecular weight determinations in such concentrated solutions since the theoretical treatment of such colligative properties as are used is limited in most cases to the dilute solutions. It was shown by Bancroft that if there is a large positive heat of dilution, the apparent molecular weight will come out smaller than it actually is, so that a polymerization might thus be masked. But Thomsen found that the heat of dilution of tartaric acid is negative. We have found the same thing to be true of malic acid. This, therefore establishes the complete validity of the freezing-point determination as indicating no polymerization in aqueous solutions of malic acid showing marked abnormalities in their optical behavior.

<sup>1</sup> Lowry and Cutter: *J. Chem. Soc.*, 125, 1465 (1924).

Nasini and Gennari report also that they kept two identical solutions of *l*-malic acid, one at 0°C and one at 80°C for three hours and then read their rotations at 20°C. The rotations were the same showing that temperature produced no permanent effect and that to each temperature there corresponds a certain equilibrium state which is attained quickly.

The abnormal properties of malic acid can not be explained on the assumption of a formation of hydrates varying with the concentration. Many years ago, Nernst<sup>1</sup> demonstrated that, according to the mass law, the ratio of hydrated to non-hydrated molecules is independent of the concentration.

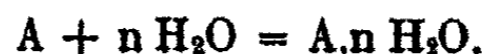

Since (H<sub>2</sub>O) is constant;

$$\frac{(A)}{(A \cdot n H_2O)} = K.$$

On this basis hydrate formation would not cause the specific rotation of an optically active solute in water to change with dilution. But this demonstration is not so conclusive as it appears, for it leaves out of consideration the relative solubilities of the two forms and is valid only when these are identical. If, as is usually the case, the hydrated form is much more soluble than the non-hydrated form, more of the hydrated form will result from dilution than the above equation provides and that demonstration loses its significance. A similar remark might be made of various other phenomena to which mass law expressions have been applied without due attention being paid to the solubility effects involved.

A number of other objections to the hydrate theory were summarized by Nasini and Gennari, who concluded that this hypothesis seems improbable here. Bell had shown that, on solution of tartaric or of malic acids, the temperature changes indicate no hydrate formation; further, in order to explain the complex changes, one must assume a very large number of hydrates and this is not probable, judging from what we know of true and definite hydrates. According to Bell, this hypothesis is inadequate for tartaric acid, since Biot observed for the molten acid the same change in rotatory power with change in temperature which he had already found in the most concentrated solution. The cryoscopic determinations also contradict this theory for, if hydrates form, the molecular depression of the freezing point should vary, decreasing with increase of concentration; actually, it remains very constant.

As has been mentioned, the supercooled malic acid changes from levorotation to dextrorotation as the temperature decreases, exactly as do the concentrated solutions of malic acid in water. The malic acid glass can scarcely be undergoing a reversible hydration and dehydration. Likewise malic acid in alcohol behaves on dilution quite as it does in water, showing greater levorotation in the alcoholic solutions. If the non-hydrated form were the dextrorotatory form, the alcoholic solutions should be more dextrorotatory than the aqueous solutions.

<sup>1</sup> Z. physik. Chem., 11, 345 (1893).

Stubbs considered hydrate formation when he investigated the effect of salts on malic acid, pointing out that hydrate formation either by the salts or the malic acid would be equivalent to a concentration leading to dextrorotation. But the salt effects were too large to be thus explained, for barium chloride at high concentration gives several times as large a dextrorotation as would be observed in the fused anhydrous malic acid, and salts with the greatest affinity for water (LiCl) actually exert the least influence. We may conclude therefore, that neither the rotation-dilution changes of malic acid nor the effects of salts can be explained by an assumption of hydrate formation.

The formation of a dextrorotatory lactone such as is believed to take place in the case of lactic acid is not a sufficient hypothesis to explain the malic acid rotations. In the salts and esters the hydrogen of the carboxyl group is replaced, with consequent loss of acidic character and, therefore, loss in capacity to combine with the alcoholic hydroxyl group to form the lactone. Nevertheless, the salts and esters exhibit the same large changes in rotation as is shown by malic acid itself. In the case of the salts we can not rule out the possibility of lactone formation from the ion according to a mechanism proposed by Holmberg.

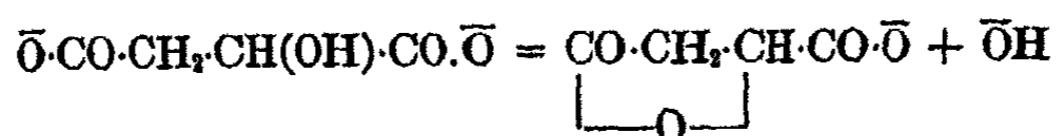

But this can surely not take place in alcoholic solutions of the esters.

The dextrorotatory form of *l*-malic acid cannot be *d*-malic acid itself, formed reversibly by the action of foreign substances or the process of dilution. If *d*-malic acid could be thus formed, a solution of inactive malic acid containing equivalent amounts of *d*- and *l*-malic acids would become dextrorotatory on addition of acids, bases or salts which cause *l*-malic acid to become less levo- or more dextrorotatory. Hydrochloric acid or sodium hydroxide impart no activity to a solution of dl-malic acid. We are forced to conclude that these inactive substances do not favor the formation of *d*-malic acid from *l*-malic; but that they have an equal and opposite effect on the optical antipodes.

This will be evident also from a consideration of the rotatory dispersion of malic acid. As is usually the case, the rotation of malic acid depends on the wave-length of light employed. There is a close parallelism between refraction and rotation, and in both light of the shorter wave-length is affected to the greater extent. This represents normal dispersion. But malic acid and tartaric acids and their common salts and esters possess anomalous dispersion in which their rotations pass through maxima at certain intermediate wave-lengths instead of increasing regularly. According to the data of Nasini and Gennari, concentrated solutions show a stronger rotation of blue light than of red. With decrease of concentration, dextrorotation of these solutions also decreases, until certain solutions are levorotatory to red light and dextrorotatory to blue light. Inactivity toward dark blue light occurs

at 16% malic acid. At this point the maximum rotation is shown toward yellow light. As dilution continues the solutions once more turn blue light through the largest angle. Such phenomena are usually interpreted as indicating the presence in the solution of two oppositely rotatory substances, each having normal but different dispersions. Lowry<sup>1</sup> believes this is not necessarily true but it appears to be true in most cases.

There are no known cases in which the dispersions of two antipodes are different. It follows from this that a mixture of unequal quantities of two antipodes, might have rotations that vary with the wave-length but there can be no maximum or minimum as make their appearances in malic acid. Further, if *d*-malic acid could have a different dispersion from *l*-malic acid, the *dl*-malic acid should show some activity. There is no observable activity in the D light and the possibility seems remote that the antipodes might have the same rotations for the D light and different rotations for all the other wave-lengths.

#### Some General Observations on Tautomerism

The treatment outlined in this paper has been based on the assumption that in tautomerisms such as are here postulated, the mobility of the hydrogen atom is greater than that of any other atom or group of atoms. This has been demonstrated in some of the examples cited, in which replacement of the mobile hydrogen by some other atom or group resulted in a compound which showed very much less tendency to tautomeric change, as indicated by the smaller rotation-dilution changes. But this is not necessarily true and a final word of qualification may be added, providing another possible explanation for the same phenomena, and, at the same time, additional proof that what we have to do with in the malic and tartaric acids is a true case of tautomeric change.

Freundler<sup>2</sup> prepared several esters of the substituted tartaric acid series in which the alcoholic hydrogens were replaced by acid groups, as for example, diethyl-diacetyltartrate. These esters were examined polarimetrically in various organic solvents which were divided into three principal groups. The first of these solvents appear to have little if any effect on the optical activity of the solute ester, solutions of all concentrations showing practically the same specific rotatory power, and this value being not markedly different from that of the pure liquid ester: this group included acetone, alcohol, and ethylene bromide. The second group of solvents raised the algebraic value of the rotations, acetic acid and carbon disulphide being included here. Finally there was a group of solvents, including benzene, toluene, chloroform, bromoform, and carbon tetrachloride which lowered the specific rotations, in many cases causing the esters, which were nearly all dextrorotatory in the free liquid state, to show levorotation in these solvents. These classifications are not rigid and do depend somewhat upon the character of the esters employed. Freundler accepted the first group of solvents as normal and fulfilling

<sup>1</sup> J. Chem. Soc., 1929, 2861.

<sup>2</sup> Ann. Chim. Phys., (7) 4, 235 (1895).

Biot's law of the constancy of rotation in the absence of any interaction between the solute and the solvent. He was not very successful in his attempt to explain the abnormal rotations on the basis of polymerization or depolymerization of the ester, solvate formation, or a kind of dissociation of the ester.

It now appears certain that what Freundler was dealing with was actually a variation of the mobility of these acid groups in the various esters and in the various solvents. In other words, there is in these tartaric acid derivatives a tautomeric change such as has been outlined in this paper for malic acid and its derivatives. It has been demonstrated by the rotations in water that this change is less in the case of the compounds in which the hydrogen is replaced by methyl, ethyl, or propyl groups. It might be presumed that the change would be greater if the hydrogen were replaced by negative groups but the constancy of acetylmalic acid does not agree with this. No definite statement can be made until more experimental work has been done on the related compounds.

In all these compounds there will be in the free state an equilibrium between the normal straight form and the oppositely-rotatory, ethylene oxide, form. Those solvents which have little or no effect on the rotations must be such that they dissolve the two forms in just about the same proportions as those in which they occur in the free state. Those solvents in which the normal form is much more soluble than the oxide form will exhibit changes of rotation and the more dilute the solutions, the farther removed will be the specific rotation from that of the solvent-free substance. Those solvents in which the oxide form is more soluble will cause the rotation of the compound to be displaced in the opposite sense algebraically, and the greater the dilution, the greater the abnormality. An example of this is found in tartaric acid which shows (for  $C = 5$ ): in water  $[\alpha]_D = +15.0^\circ$ ; in alcohol-benzene  $-4.0^\circ$ .

While this aspect of tautomerism, involving groups other than the hydrogen atom, has not been emphasized, there are many instances of it in the literature. Cohen<sup>1</sup> gives numerous examples of the migration of hydrocarbon radicals from which we select a few which are relevant. On p. 398 is found; "McKenzie and his co-workers<sup>2</sup> have made the interesting observation that certain  $\alpha\beta$ -amino alcohols when acted upon by nitrous acid undergo similar transformations to the semipinacolinic change, which he termed 'semipinacolinic deamination'.

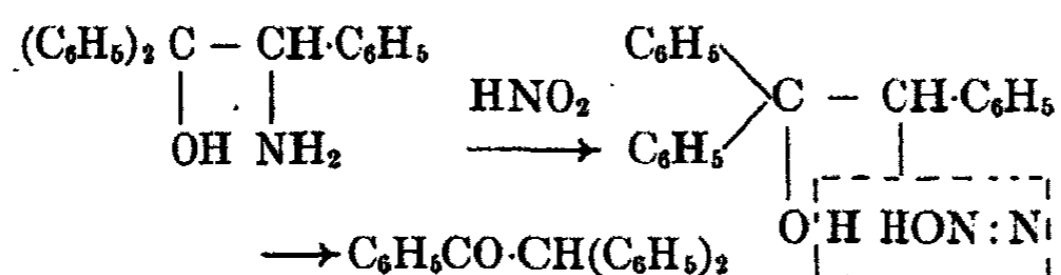

It will be noticed that in this reaction the amino group is detached and any transference only involves the radicals attached to the carbinol carbon. In

<sup>1</sup> "Organic Chemistry", 2, (1928).

<sup>2</sup> J. Chem. Soc., 123, 79 (1923); 125, 848, 2148 (1924); (1926), 779. Luce: Compt. rend., 180, 145; Orekhoff and Fogar: 70 (1925).

this way the study of the preferential migration of different radicals is determined more easily and accurately. By applying this method it was shown that phenyl migrates more readily than methyl, and naphthyl and anisyl more readily than phenyl."

On p. 404 are found examples of the migration of ethyl groups from ethoxy groups and of acetyl groups. "Claisen<sup>1</sup> found that isoacetophenone ethyl ether when boiled under pressure changes into phenylpropyl ketone.

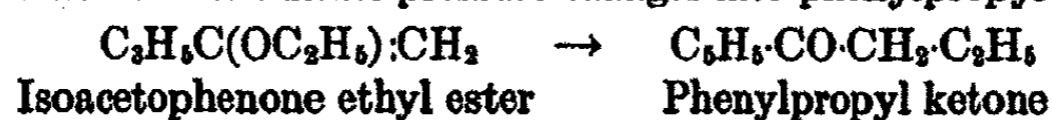

He also showed that the acetyl derivative of hydroxyacetic ester (from acetoacetic ester, acetyl chloride, and pyridine) was transformed by means of potassium carbonate and a little acetoacetic ester, or by sodium acetoacetic ester into diacetoacetic ester.<sup>2</sup>

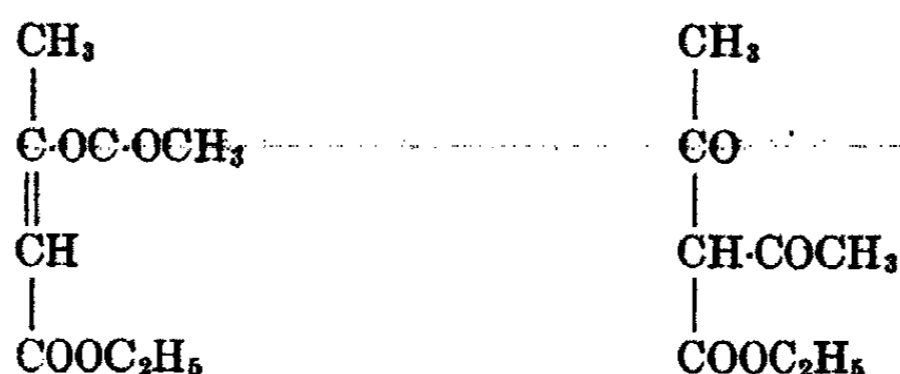

The corresponding alkyl derivatives do not undergo this conversion."

This last statement can not be true. It must mean that the positive methyl group migrates from a  $-\text{COCH}_3$  group less readily than a negative acetyl group migrates from a similar  $-\text{C}\cdot\text{O}\cdot\text{COCH}_3$  group. This could have been predicted from what has been said above. Immediately following the above quotation, Cohen continues: "Acetophenone O-benzoate,<sup>3</sup> on the other hand, is converted in much the same way by the action of metallic sodium and a little acetophenone into the sodium compound of dibenzoylmethane."

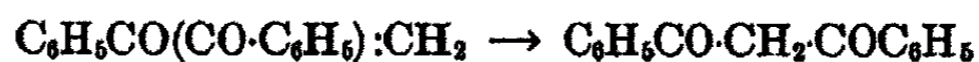

"A reaction of a character similar to the foregoing is the conversion of the acetyl derivatives of the polyhydric phenols into acetyl derivatives of the cyclohexanones when heated with zinc chloride."<sup>4</sup>

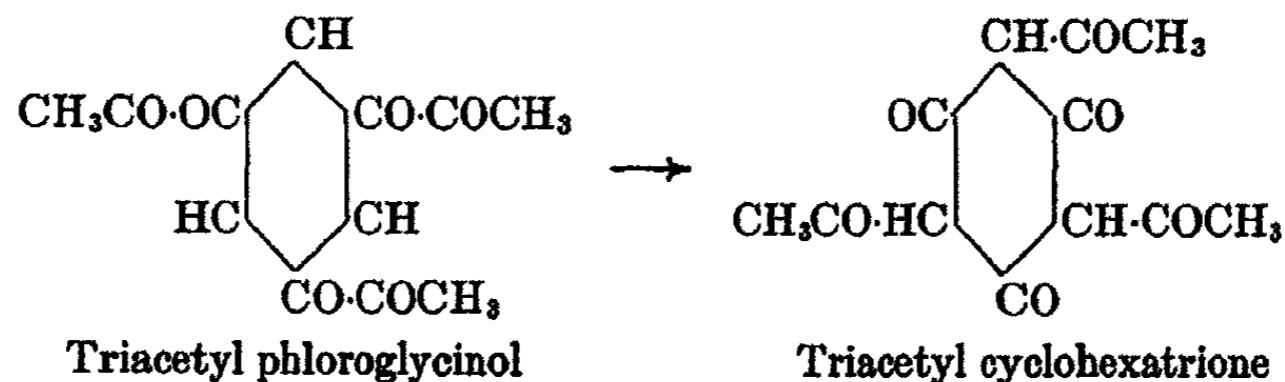

<sup>1</sup> Ber., 29, 2931 (1896).

<sup>2</sup> Ber., 33, 3778 (1900).

<sup>3</sup> Claisen and Haase: Ber., 36, 3678 (1903).

<sup>4</sup> Heller: Ber., 42, 2736 (1909); 45, 418 (1912).



It is clear, then, that not only hydrogen migrates but also positive or negative groups replacing hydrogen may participate in dynamic isomerism. In the cases considered, it appears that the positive groups migrate less readily and the negative groups more readily than the hydrogen atom. This must, however, depend upon the character of the groups attached to the carbon atoms in question and upon the solvents employed.

This effect of the solvent on the ordinary keto-enol tautomerism has been studied extensively. Certain other isomeric changes have likewise been investigated by Dimroth (Cohen, II, 378). "He determined the relation between the solubilities and the velocity of transformation of phenylhydroxy-triazole carboxylic ester and its amino derivatives in a great variety of solvents."<sup>1</sup>

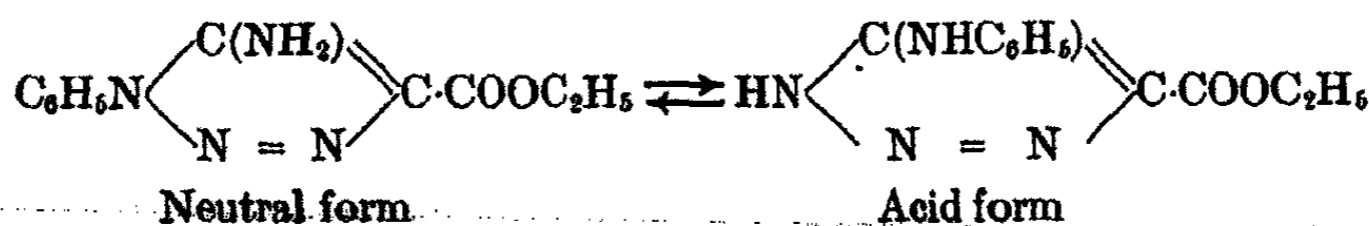

#### Phenylaminotriazole-carboxylic ester

The second or acid form of the above modifications can be titrated with alkali and thus quantitatively determined in presence of the first or neutral form. Dimroth found that the velocity of change is determined by the relative solubilities of the isomers, and is smaller the greater their solubility in the solvent, or, in other words, the velocities are approximately inversely proportional to the solubilities. This principle had already been arrived at on theoretical grounds by van't Hoff in 1898.<sup>2</sup> Van't Hoff regards the effect of the solvent on the velocity to be two-fold: the one is catalytic, and influences both reactions equally, whereas the other affects the two reactions differently, and depends upon some interaction between the reacting substance and the solvent. This influence of the solvent on the equilibrium is a function of the solubility of the reacting substances, and, according to Dimroth, may be expressed by the equation:  $\frac{C_a}{C_b} = G \frac{L_a}{L_b}$ , where  $C_a$  and  $C_b$  are the concentrations of the two isomers, and  $L_a$  and  $L_b$  their solubilities,  $G$  being a constant which is independent of the nature of the solvent; in other words, the two substances undergoing isomeric change are in equilibrium in any solvent when their concentrations are proportional to their solubilities multiplied by the constant  $G$ , or when the ratio of their concentrations reaches the value  $G$ , which is called the absolute equilibrium constant." The data for the methyl and ethyl esters support this formulation fairly well.

The conclusion of this section may be summarized briefly. In the optical rotatory power of malic acid and tartaric acid we have a convenient property by which to recognize the existence and degree of isomeric change which involves the alcoholic hydrogens of these compounds. Some of the deriva-

<sup>1</sup> Ann., 377, 127 (1911); 438, 58, 67 (1924).

<sup>2</sup> "Vorlesungen über theoret. und physik. Chemie", 1, 217 (1898).

tives of these acids may exhibit little or no change of optical rotatory power in any solvents. For these we may conclude that isomeric change is absent or negligible. Nearly all of the derivatives will probably exhibit marked changes in rotation on solution in certain solvents, and relatively slight changes in other solvents. In this latter case the constancy of the rotatory power is an indication that although migration of the substituted groups still takes place, the two isomeric forms have in those solvents solubilities which are proportional to the concentrations of the two forms in the solvent-free active substance. When this happens addition of solvent does not displace the equilibrium existing between the forms and can, therefore, produce no change in the specific rotatory power of the mixture. If, on the other hand, one form has in a given solvent a markedly greater solubility than the other form has in that solvent, addition of solvent to the free substance will displace the equilibrium in favor of the more soluble form and this will be evidenced by a change of rotation on dilution.

Applying this to malic acid, the conclusion is inevitable that the supercooled anhydrous acid is a mixture of tautomeric forms, with the dextro-rotatory ethylene oxide form predominating, at least in so far as rotation is concerned. Addition of water displaces this equilibrium in favor of the normal straight levorotatory form which shows this form to be the more soluble in water. Alcohol is even more effective in this direction.

In the consideration of the substituted malic acids as the methoxysuccinic and acetylmalic acids, the question arises as to whether the constancy of rotation observed in their aqueous solutions is to be attributed to a lack of migration on the part of the substituted groups or to a proper solubility ratio on the part of the water. The work of Freundler demonstrates that the acetyl and other acid groups in substituted tartaric esters do migrate in some solvents, while in other solvents the rotation is constant in dilution. It appears equally probable that in some other solvents than water, these substituted malic acids will also show large deviations from the nearly constant value of their aqueous solutions, so that in the large majority of cases we must assume a large migration is possible and whether or not it takes place is determined by the solubility relationships. Since ionization plays no significant role in this phenomenon, the investigation of this isomeric change may well be carried out with the esters, in order to take advantage of their greater solubility (over the acids) in the common organic solvents. This work would serve to show that the general rules of tautomeric change are followed in this example and to establish the properties not only of the straight ordinary forms of these acids but also of the oppositely rotatory ethylene oxide forms.

#### Summary

The optical rotatory power of malic acid exhibits wide variations with changes of the environment and conditions in which it is observed. In particular, the rotation of *l*-malic acid changes from negative to positive values as the aqueous solution is concentrated. Salts, acids and bases exert a similar influence, while rising temperature makes the solutions more levorotatory.

Previous attempts have been made by many authors to explain these changes in terms of ionization, polymerization, hydrate formation,  $\beta$ -lactone formation, and formation of *d*-malic acid from *l*-malic acid. All of these explanations have been shown to be inadequate.

A number of the previous investigators in this field, however, have agreed that the optical rotation of malic acid may be accounted for satisfactorily by the assumption that there exist two oppositely rotatory forms of *l*-malic acid in a dynamic equilibrium which is affected by the changes in environment and which therefore causes the changes in the rotatory power of the mixture as one form is created at the expense of the other. In particular, the anomalous dispersion and the evidences of mutarotation found in malic acid and in the closely related tartaric acid lend credence to this explanation, and all the facts agree with it. There has been no agreement as to just what these two forms are.

This paper proposes an answer to this question. It appears probable that the ordinary form (I) of *l*-malic acid is the levorotatory form in question. The dextrorotatory form (II)

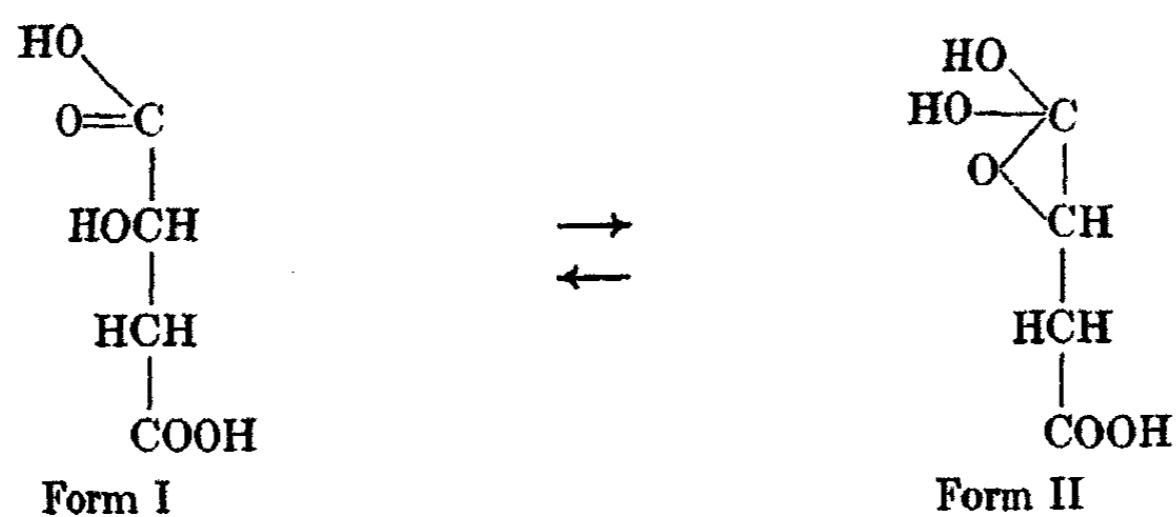

arises from this when the hydrogen of the alcoholic hydroxyl group migrates to form with the ketonic oxygen of the adjacent carboxyl group a second hydroxyl group there. The resultant ethylene oxide linkage gives rise to the observed dextrorotation of this form.

Evidence for this tautomeric change is found in the fact that when the migrating alcoholic hydrogen of malic acid is replaced by groups which are less labile, to form such compounds as methoxysuccinic acid, ethoxysuccinic acid, propoxysuccinic acid etc., these compounds are found to possess remarkably constant rotations as their concentrations in aqueous solutions change greatly. Likewise, when the hydroxyl group is replaced by chlorine, chlorosuccinic acid is found to be very slightly influenced by changes in concentration and in temperature, while replacement of the hydrogen directly attached to the asymmetric carbon atom by a methyl group in citramalic acid gives rotations which vary with dilution but to a much smaller degree than those of malic acid. This is due to the decrease in activity incident on passing from a secondary to a tertiary alcohol grouping on that carbon atom; some migration exists but much less than in malic acid. Finally, if this migrating

hydrogen is replaced by groups containing metallic atoms, such as beryllium and uranyl, the metallic derivatives show constant rotations.

It is clear that this migration of the alcoholic hydrogen is to the adjacent carboxyl group and not to the more distant one since numerous  $\alpha$ -hydroxy acids show this sensitivity to concentration changes while the rotatory power of  $\beta$ -hydroxybutyric acid is remarkably constant with dilution.

Numerous organic compounds are known to possess structures and properties and to undergo changes analogous to those here discussed for the two forms of malic acid. Phenyl azo acetic ester and glucose are cases in point.

This reversible change between the two forms of malic acid is discussed as an example of a special type of tautomeric change to which the general rules of such dynamic isomerism must apply. It is suggested that the optical properties and the ease of replacements in the malic and tartaric acid series offer an inviting field for the further investigation of this subject. Such an investigation should furnish some very interesting information as to the specific properties of the levorotatory and the dextrorotatory forms of *l*-malic acid, as well as to the conditions under which the respective forms are most stable. This will undoubtedly contribute also the knowledge of the role various solvents play in such examples of dynamic isomerism.

*Cornell University*

THE ELECTRODEPOSITION OF METALS FROM THEIR  
LIQUID AMMONIA SOLUTIONS

16-223

BY ROBERT TAFT AND HAROLD BARHAM\*

It has been known for many years that the form of electrodeposited metals from aqueous solutions of their salts could be varied at will by changing the conditions under which the metal was deposited. A systematic study of the factors influencing the form of the deposit has been made by Bancroft,<sup>1</sup> Aten,<sup>2</sup> Hughes,<sup>3</sup> Kohlschütter,<sup>4</sup> and especially by Blum and co-workers.<sup>5</sup>

Blum has shown the influence of several factors upon the form of the metallic deposit from a purely experimental standpoint. Some of these determining factors as listed by Blum include current density, concentration of salt and agitation, temperature, conductivity, metal ion concentration, hydrogen ion concentration, addition agents, and structure of base metal.

The similarity between water and liquid ammonia in their chemical properties has long been known. Many salts are solvated by these two substances to form respectively hydrates and ammoniates. They are also similar in their solvent action, which is probably chemical, dissolving many substances, both organic and inorganic. Each of them possesses the property of causing dissociation when inorganic salts are dissolved in them and, consequently, show the phenomenon of electrolysis when an electric current is passed through their solutions.

On account of this similarity between water and liquid ammonia it was thought that a fairly extensive study of the form of metals deposited electrolytically from liquid ammonia solutions would be of interest in that the influence of controllable factors, such as has been done for aqueous solutions, could be studied by the use of this different solvent, further the influence of the solvent on the form of the metal could be shown; and lastly, there would be the possibility of commercial utilization of any one of the electroprocesses which appeared to possess any advantages over its corresponding aqueous analog. For our purposes the electrodeposition of the following metals was studied: lead, nickel, cadmium, copper, silver, zinc, chromium, and aluminum. This list is representative both from a chemical and industrial standpoint; and further, Groening and Cady<sup>6</sup> have shown that most of these metals possess a higher metal overvoltage in liquid ammonia than in water, a property which, as pointed out by Bancroft, tends toward the production of a "good" deposit. In describing a deposit, it was necessary to

\* University of Kansas, Lawrence, Kansas.

<sup>1</sup> *Trans. Am. Electrochem. Soc.*, 6, 27 (1904); 23, 266 (1913).

<sup>2</sup> *Rec. Trav. chim.*, 39, 720 (1920).

<sup>3</sup> *Bull. 6, Dept. Sci. and Ind. Res., London*, 1922; *Beama*, 12, 215 (1923).

<sup>4</sup> *Z. Elektrochemie*, 24, 300 (1918).

<sup>5</sup> *Trans. Am. Electrochem. Soc.*, 36, 212 (1919).

<sup>6</sup> *J. Phys. Chem.*, 30, 1597 (1926).

have a concept as to what a "good" deposit should be. The following is a statement of the characteristics which we have considered as belonging to a good deposit:

A deposit may be said to be "good" when it is non-porous, compact, hard, fine-grained, and adherent.

#### Method and Apparatus

Our experimental procedure consisted in varying several or all of the following factors. When the individual metals are considered, it will be indicated as to which of these factors were varied.

1. Current density
2. Metal ion concentration
3. Hydrogen ion concentration, acidity
4. Anion, nature of anion
5. Temperature
6. Metal base
7. Addition of colloids
8. Stirring

The method employed consisted in weighing out the desired quantity of salt and dissolving it in 100 c.c. of liquid ammonia which had been placed in a wide-mouthed test tube shown in Fig. 1. The liquid ammonia employed came from a cylinder of the commercial product. It was drawn from the cylinder into a Dewar flask and used directly in the preparation of solutions. All of the electrolyses were made at the boiling point of liquid ammonia unless stated to the contrary.

Electrodes two cm. wide and about 18 cm. long, which had been thoroughly cleaned with acid dip, polished with fine pumice stone and weighed, were placed in rubber spacings two cm. apart and the whole inserted into the cell. It was difficult with thin electrodes to keep the electrodes from bending slightly in or out. The electrolyses were made out of contact with air, the electrodes being set in sealing-wax and fitted into the rubber stopper. A mercury trap was arranged and attached to the cell to exclude the air. The cell was placed in a wide-mouthed Dewar flask and around the cell was poured some liquid ammonia which served as a bath. To obtain lower temperatures, enough liquid air was added to the ammonia to give the required temperature. Stirring was done with an auger-shaped glass stirring rod, introduced between the electrodes, and driven by an electric motor. In proceeding with the electrolysis, the required current was shunted from a 110 volt D.C. line, and time and voltage data taken. The number of coulombs which had passed through a cell was calculated from current (read from an ammeter in series with the cell) and time data, the ammeter used having been previously compared with an iodine coulometer. The current efficiencies were then calculated from the metal deposited (or dissolved at the anode) in

accordance with Faraday's laws on the basis of the valency of the metal as it existed in the salt used in making up the solution. Current densities were computed on the basis of the area of one side.<sup>1</sup>

The resulting deposits were removed after the electrolysis, washed, dried, and weighed. Some of them were difficult to wash entirely free from adhering salts without the removal of some of the deposits. This introduced an error into the current efficiency values, especially when the deposits were poor. After weighing the deposits, they were studied as carefully as possible, described, and finally photographed. Microphotographs with a magnification of twenty times were made on lead deposits. The remainder were photographed at approximately natural size. Several deposits of lead, cadmium, copper, silver and zinc are reproduced in Figs. 3 to 7, inclusive.

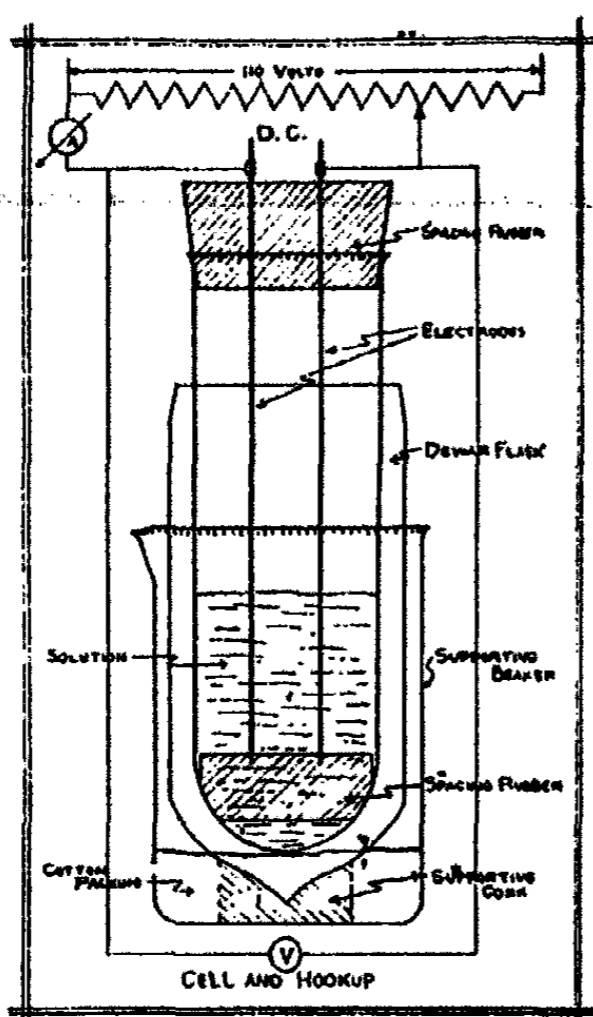

FIG. 1

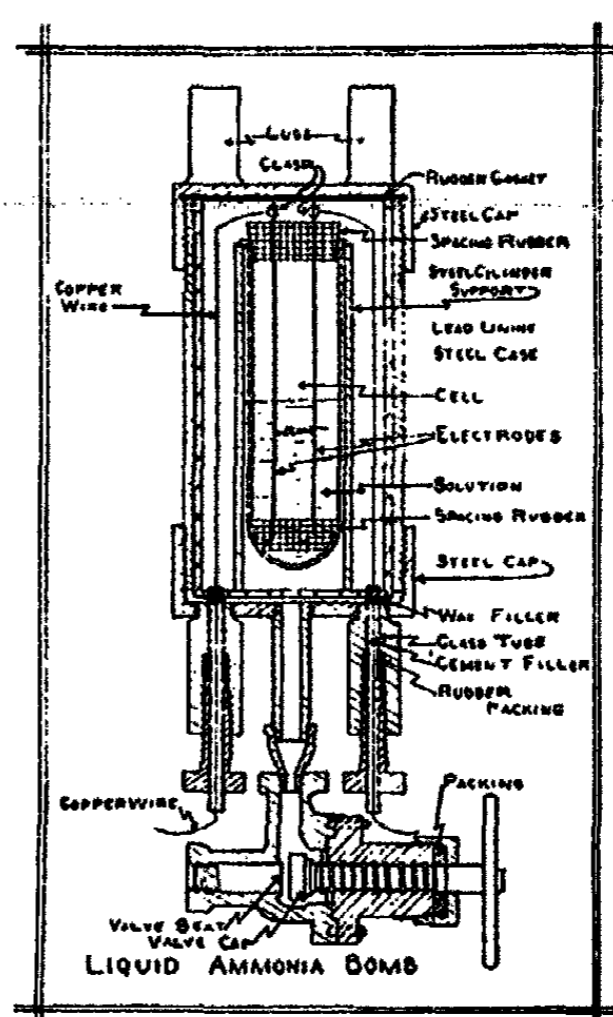

FIG. 2

For the study of cadmium deposits, it being desirable to carry out the electrolyses at room temperature and at a corresponding pressure (about 150 lbs. per sq. in.), a pressure bomb was constructed, a cross-section of which is shown in Fig. 2. The walls of the bomb were made of heavy-walled gas piping, and the top and bottom caps were ordinary gas-pipe fittings. To the top cap were welded two heavy steel lugs to be used in tightening and removing the top cap. Within the walls was placed a lead sheet which protected them from the splattering of the cadmium salts which are highly corrosive under these conditions. The rubber gasket served the double

<sup>1</sup> From the current and the potential drop across the cells as tabulated below, approximate values of electrical resistances of the solutions may be computed. From the current densities and potential drops, as given, and the distance between electrodes (2 cm.) approximate values of the specific resistances of the solutions may be computed.

purpose of preventing leakage from the top and corrosion of the cap. Into the lower cap were placed two carefully-machined packing glands, through which passed the copper leads. The copper wire was set in litharge-glycerine cement within a heavy-walled, soft-glass tubing, one end of which was sealed with rubber cement to prevent leakage through the porous cement below. The tube and wire were packed into the gland with pure rubber packing. A cast-iron valve was also fitted to the lower cap to permit the release of the pressure at any desired rate. It was found that comparatively rapid release of the pressure was necessary as the long standing of the cadmium deposits in contact with the solution destroyed them. The cell and contents were placed in a metal cylinder inside the bomb (this permitted equilibrium to be established rapidly) as is shown in Fig. 2.

#### Solutions of Lead Salts in Liquid Ammonia

Among the salts of lead listed by Franklin<sup>1</sup> and Kraus as being soluble in liquid ammonia, were lead acetate, lead nitrate, and lead iodide. Of these lead acetate and lead nitrate were used in our experiments. The anhydrous character of lead nitrate made it the more useful in carrying out electrolyses under conditions in which a minimum quantity of water was present.

A number of electrolyses were made, the results of fifteen of these trials being recorded in Table I, and the form of several of the cathode deposits being photographically recorded in Fig. 3.

The results of these trials may be summarized briefly in terms of the factors previously stated under method.

1. Current density. Increasing the current density decreases the size of the nodules as shown in the data for Cells 1 to 3. At the same time the area covered by the deposit becomes greater. As the current density becomes greater, however, the tendency for treeing becomes more pronounced.

2. Metal ion concentration. A comparison of the results of cells #4 and 5 and #9 and 10 showed that as the concentration of salt increased the tendency to treeing decreased.

3. Acidity. The ammonium salts in liquid ammonia behave as acids, i.e., solvated hydrogen ions are formed when dissolved in ammonia. In aqueous solutions acids are added for several purposes, e.g., to increase conductivity; to prevent hydrolysis of salts and deposition of oxides, etc. The solutions of lead nitrate were invariably opalescent and the deposits were striated. The opalescence and production of striae are evidence of the presence of colloidal material in the solution, undoubtedly a basic salt (rather its ammonia analog) of lead. The addition of the acid ( $\text{NH}_4\text{NO}_3$ ) removed the opalescence and the deposit was no longer striated (Cf. Cells 7 and 8). The statements made in Paragraph 7 below should also be considered in this connection.

4. Nature of the anion. The substitution of lead acetate for nitrate produced non-striated clearly crystalline deposits. It should be noted in

<sup>1</sup> Am. Chem. J., 20, 820 (1898).



this case that the difference might possibly be due to the presence of water as the acetate was added in the form of the trihydrate whereas the nitrate was anhydrous. (Cf. also paragraph 7 below).

5. Temperature. Cells #5 and 6 were run at temperatures twenty-five degrees below the temperature of the remaining cells. These cells are comparably to #1 and 4, other factors being the same. The chief difference noted here was the reduction in size of the nodules produced and a resulting increase of area covered by the deposited lead.

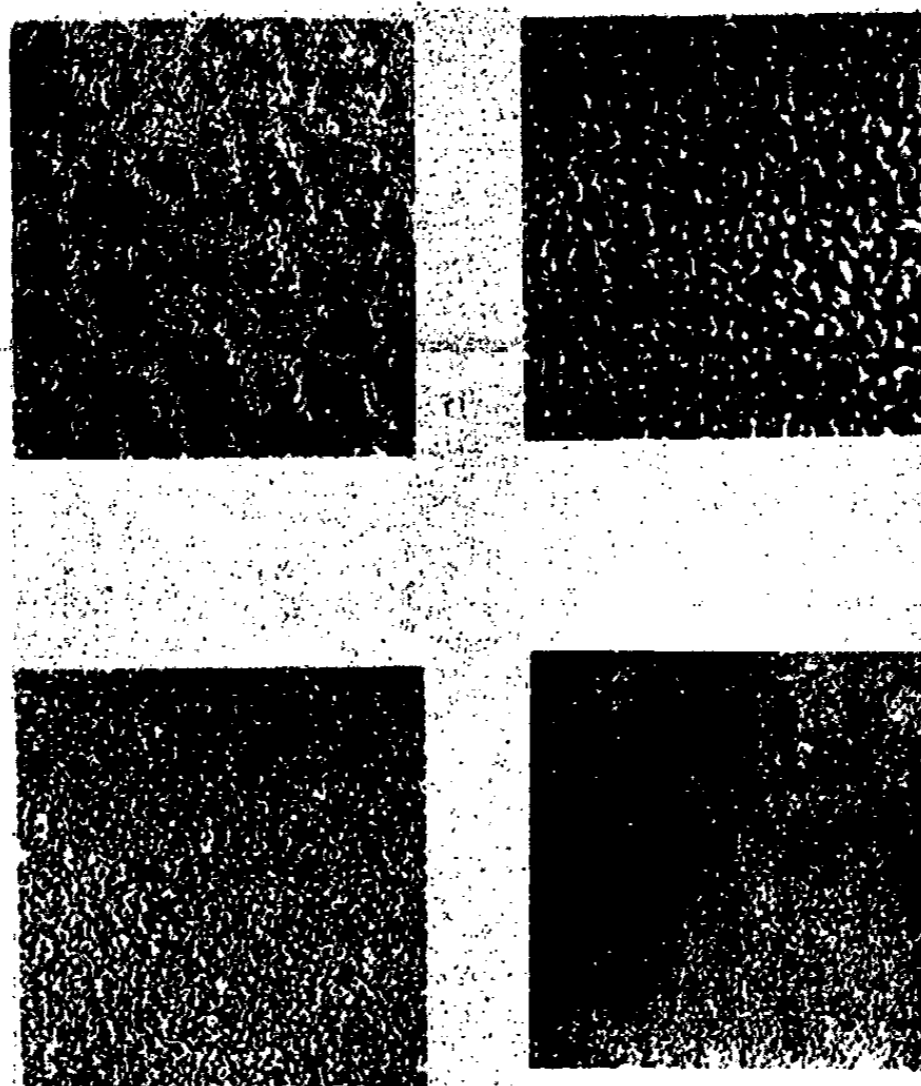

FIG. 3  
Lead Deposits  $\times 20$   
Upper left—Cell 2, Table I.  
Upper right—Cell 8, Table I.  
Lower left—Cell 12, Table I.  
Lower right—Cell 18, Table I.

6. In several trials, iron was substituted for lead as the cathode material. The more important commercial applications of lead plating from aqueous solutions are concerned with its deposition on this base. It was for this reason that iron was chosen in preference to some other metal. As will be seen by examination of Table I, a comparison of Cells 2 and 7, 10 and 12, and 17 and 18 shows that the substitution of iron for lead as cathode material resulted in the production of smaller nodulae. A comparison of cells 10 and 12 is particularly suggestive as here the substitution of iron for lead results in an apparent decrease in the crystallinity of the deposited metal.

TABLE I

Cell No.	Cathode Material	Anode Mat'l	Composition Solution	Current Amperes	Density dm	Potential Drop volts	Coulombs calc. from current	Cathode Efficiency %	Anode Efficiency %	Description of Deposit
1	Pb	Pb	(100 c.c.) 1N Pb(NO <sub>3</sub> ) <sub>2</sub>	0.1	.4	.35	180.	114.	113.	Clusters of nodules, striated along vertical axis
2	Pb	Pb	1N Pb(NO <sub>3</sub> ) <sub>2</sub>	0.2	1.0	.66	374.4	98.	103.	Similar to #1; Nodules are smaller and more irregularly spaced
3	Pb	Pb	1N Pb(NO <sub>3</sub> ) <sub>2</sub>	0.3	1.74	1.0	540.	102.	100.	Similar to #1; Smaller and closer together
4	Pb	Pb	2N Pb(NO <sub>3</sub> ) <sub>2</sub>	0.1	.5	0.2	180.	104.	103.	Similar to #1; Smaller and more nearly spherical
5	Pb	Pb	1N Pb(NO <sub>3</sub> ) <sub>2</sub>	0.1	.5	.37	192.	98.	101.	Similar to #1; Nodules considerably smaller
6	Pb	Pb	2N Pb(NO <sub>3</sub> ) <sub>2</sub>	0.1	.5	.14	180.	99.	99.	Similar to #1; Area covered by deposit greater
7	Fe	Pb	1N Pb(NO <sub>3</sub> ) <sub>2</sub>	0.2	.9	.72	372.	107.	104.	Nodules very small—very well defined striae
8	Fe	Pb	1N Pb(NO <sub>3</sub> ) <sub>2</sub> + 1 gm. NH <sub>4</sub> NO <sub>3</sub>	0.2	1.0	.61	372.	108.	113.	Nodules larger than in #7; no striae
9	Pb	Pb	1N Pb (C <sub>2</sub> H <sub>5</sub> O <sub>2</sub> ) <sub>2</sub> ·3H <sub>2</sub> O	0.1	.5	2.5	Subsequent trials not determined			Small crystals; no striations
10	Pb	Pb	2N Pb (C <sub>2</sub> H <sub>5</sub> O <sub>2</sub> ) <sub>2</sub> ·3H <sub>2</sub> O	0.1	.5	2.2	Subsequent trials not determined			Small crystals and nodules—no striation
11	Fe	Pb	1N Pb (C <sub>2</sub> H <sub>5</sub> O <sub>2</sub> ) <sub>2</sub> ·3H <sub>2</sub> O	0.1	.5	4.75	Subsequent trials not determined			Crystalline—very few nodules—no striation
12	Fe	Pb	2N Pb (C <sub>2</sub> H <sub>5</sub> O <sub>2</sub> ) <sub>2</sub> ·3H <sub>2</sub> O	0.1	.5	2.3	Subsequent trials not determined			Small nodules—few crystals—no striations
13	Fe	Pb	1N Pb(NO <sub>3</sub> ) <sub>2</sub> + 1 gm. gliadin	0.2	1.0	.7				Little different than #7
17*	Pb	Pb	1N Pb(NO <sub>3</sub> ) <sub>2</sub> + 1 gm. NH <sub>4</sub> NO <sub>3</sub>	0.2	1.0	—				Smooth, uniform and adherent
18*	Fe	Pb	1N Pb(NO <sub>3</sub> ) <sub>2</sub> + 1 gm. NH <sub>4</sub> NO <sub>3</sub>	0.2	1.0	.6				Smooth, uniform and adherent Grain smaller than #17

\* The bath in these two cells was rapidly stirred

7. Many colloidal materials are added in small concentration to aqueous plating baths to increase the fineness and toughness of the deposit. Little is known about the ability of liquid ammonia as a colloidal dispersion medium. Taft<sup>1</sup> has pointed out that a few substances disperse in liquid ammonia. Of these gliadin and cellulose nitrate were tried. A comparison of the cathode deposits in cells 7 and 13 shows but little difference in the form of the deposits. Cellulose nitrate does not disperse readily in liquid ammonia solutions of lead nitrate. Traces of cellulose nitrate made no material difference in the form of the deposit. (This cell is not recorded in Table I). The conclusion should not be drawn, however, that addition agents have no effect in liquid ammonia plating baths. On the contrary the effects described under paragraph 3 above indicate the possibility of the origin of the difference between plating baths of lead nitrate and lead acetate may be due to the presence of the colloidal basic nitrate.

8. Effect of stirring. In cells 17 and 18 the bath was rapidly stirred in the manner previously described. A comparison of these two cells with #7 shows a very marked improvement in the quality of the deposit. In fact, the deposit obtained in these two cells compared favorably with deposits obtained from aqueous fluosilicate or fluoborate baths. The high cathode efficiencies obtained were due to inclusions of salts and to oxidation of deposit. It was difficult without elaborate experimental procedure to prevent either of these occurrences. The high anode efficiencies were ascribed to the solvent action of the ammonia or to mechanical disintegration.

#### Solutions of Nickel Salts in Liquid Ammonia

Of the nickel salts listed by Franklin and Kraus, only one,  $\text{Ni}(\text{NO}_3)_2 \cdot 6\text{H}_2\text{O}$ , is soluble in liquid ammonia, and it is only moderately soluble. Consequently, in the first series of experiments carried out with nickel cells, this salt was used in the electrolyte. However, it was found that very little metal was dissolved at the anode and less deposited at the cathode, gas being evolved vigorously at both electrodes. Groening and Cady have observed that anhydrous solutions of nickel salts in liquid ammonia are red in color, but those which we obtained using the hexahydrate were purple. Water was added to solutions of the hexahydrate in the attempt to determine the influence of water upon the efficiencies at the electrodes. It was found that, although the electrode efficiencies were initially small, they were even smaller in the case when water was added.

Other salts were tried with the idea of obtaining some anhydrous salt which is soluble in liquid ammonia. Nickel acetate is soluble enough to color the solution slightly but not enough to warrant its use in the electrolysis of solutions. Several salts were added to solutions of nickel acetate with the hope that more soluble salt of nickel would be formed. Only one salt,

<sup>1</sup> Trans. Kansas Acad. Science, 32, (1929).

$K_2Cr_2O_7$ , had any effect at all, but any increased solubility was far overbalanced by increased gassing at the electrode. NiO, unlike CuO, is practically insoluble in liquid ammonia.

As the preparation of anhydrous nickel nitrate is very difficult, we decided to prepare an amino-derivative. This was done by repeated recrystallizations from liquid ammonia, after which it was heated to about  $95^\circ C$  for a period of three hours. The results of the analysis of this salt are as follows:

Sample	% $NH_3$ Determined from analysis	Theoretical
1	34.3%	35.51%
2	34.6%	

The above theoretical values are those calculated on the basis of hexammino-nickel nitrate. The agreement to be sure is none too good, but when it is considered that salts of this nature have quite variable composition, discrepancies of this magnitude would not be surprising.

The ammine thus prepared was the salt used to form the nickel solutions employed in the study of electro-deposited nickel. In order to be certain that there was no water present in the ammonia as it came from the cylinder, the ammonia was dehydrated by means of metallic sodium and distilled into the glass cylinder to be used as the cell. Even with these precautions the initial solution was not red in color. It was observed, however, that upon continued electrolysis, the solution became a deep red. With the cell in use, it was not possible to tell whether the red substance was produced as the result of a secondary reaction, reduction at the cathode, or oxidation at the anode. A special cell was built with separate cathode and anode compartments. After electrolysis had been carried out over a long period of time with a current density at which there was no visible gassing at either electrode (0.23 amp. per sq. dm.) a deep red layer of solution was to be seen around the anode. Tubandt and Riedel<sup>1</sup> have studied the formation of nickelic salts in aqueous solution and have observed that they are red in color. These salts possess the property of oxidizing potassium iodide, liberating free iodine. This red anode solution was treated with potassium iodide in an acid solution and a considerable quantity of free iodine was liberated. A blank was run, using an equal amount of nickel salt, to find whether the oxidation was due to the anode solution (nickelic ion) or to free nitric acid. A small quantity of iodine was liberated in the blank solution which, upon titration with standard thiosulphate solution, was found to be about one tenth of that liberated from the anode solution. Overvoltage measurements show that both the cathode and anode overvoltages decrease with time. This must be due to a variable decomposition potential at a constant current density. The anode efficiency indicates also that the current is utilized in processes other than the oxidation of nickel. It appears also that the character of the deposit becomes poorer with time. At a current

<sup>1</sup> Z. anorg. Chem., 72, 219 (1911).

density of 0.23 amp. per sq. dm., a good deposit of nickel is at first formed, but when the electrolysis is carried out over a long period of time, the deposit becomes a black. From the above considerations, it is evident that in the electrolysis of nickel solutions in liquid ammonia, there is some oxidation of the nickel from the nickelous to the nickelic condition at the anode.

The results of sixteen electrolyses are recorded in Table II. In the cells recorded in Table II both anodes and cathodes were of nickel; the term ammino refers to nickel hexammino nitrate; hexa refers to nickel nitrate hexahydrate.

An examination of the above data may be summarized in terms of the variables previously mentioned.

1. Current density. The results of the above experiments indicate, as far as the effect of current density is concerned, that the best nickel deposits are obtained only when the current density is small—0.14 amp. per sq. dm. or less. Even then, if the process is prolonged, the good deposit is covered with a black coating. Given a certain metal concentration, current densities above or below critical current densities produce poorer deposits. As it is increased above this value, a blackening is first produced which is followed by the formation of greenish growths; later a loose, flaky, metallic deposit is produced, due no doubt to escaping gases.

2. Effect of the change of metal concentration. As previously mentioned, the solubility of nickel nitrate in liquid ammonia is quite small. It was found that two grams of the ammino salt would scarcely dissolve in 100 c.c. of liquid ammonia. Consequently, the cells in which were placed two grams of the salt, contained a saturated solution and there was always a slight excess of salt. The second series of cells contained a solution in which 1 gm. of the salt was dissolved per 100 c.c. of liquid ammonia. Results of experiments show that the effect of the increase in metal concentration is to increase the current density producing a good deposit.

3. Effect of change in hydrogen ion concentration. When the solution of the hexahydrate in liquid ammonia is made acid with ammonium nitrate, the efficiency at the cathode is made very small. The small amount of deposit is poor from the standpoint of a nickel plate. There was vigorous gassing at both electrodes.

Probably here, as in aqueous solutions, the conditions for a "good" deposit are dependent upon the determination of a critical pH. Weak acids were not tried.

4. Character of base metal. There was little difference to be found in the character of the deposit when iron was substituted for nickel as the cathode. The potential drop in the cells which contained iron as the cathode was smaller than those which contained nickel.

#### Solutions of Cadmium Salts in Liquid Ammonia

Franklin and Kraus list only one cadmium salt as being quite soluble in liquid ammonia, cadmium nitrate. Cadmium iodide is given as being slightly

TABLE II  
Nickel Nitrate

Cell No.	Solute Gm/100c.c. NH <sub>3</sub>	Current Amperes	Current Density amps/sq.dm.	Potential Drop, volts	Coulombs calc. from Current	Cathode Efficiency	Anode Efficiency	Description of deposit
1	Ammino 1	0.01	.07	1.3	63.	133.	93.	Very fine, black, uniformly distributed over cathode surface; adherent
2	Ammino 1	0.02	.15	1.6	264.	74.	54.	Similar to #1; Contained green areas. Green areas granular and non-adherent
3	Ammino 1	0.03	.20	2.1	1120.	107.	92.	Same as #2
4	Ammino 1	0.04	.27	3.3	144.	122.	75.	Similar to #2; Green area larger—Back deposit peels; gassing.
5	Ammino 1	0.05	.34	3.8	180.	119.	80.	Main deposit, greenish black; three small areas of bright metal; gases evolved
6	Ammino 1	0.06	.44	4.5	216.	111.	82.	Loose, flaky deposit containing some bright metal and some black deposit; excessive gassing
7	Ammino 1	0.07	.51	4.9	260.	103.	76.	Similar to #6; deposit somewhat more flaky
8	Ammino 2	0.01	.07	1.2	63.	89.	65.	Better than #1; somewhat darkened
9	Ammino 2	0.02	.15	1.6	264.	113.	95.	Fine bright adherent deposit at 105 minutes; at 220 minutes deposit was black
10	Ammino 2	0.03	.23	2.	1120.	114.	95.	Part bright and part black; also included green areas
11	Ammino 2	0.04	.29	2.7	144.	120.	79.	Bright area decreased; green area increased
12	Ammino 2	0.05	.35	5.	180.	118.	73.	Green deposit over entire cathode
13	Ammino 2	0.06	.44	3.4	216.	128.	80.	Same as #12
14	Ammino 2	0.07	.51	3.7	260.	128.	75.	Same as #12
15	Hexa 2.91	0.1	1.1	4.2	720.	19.	50.	Small black deposit
16	Hexa 2.91 + 1 gm. NH <sub>4</sub> NO <sub>3</sub>	0.1	1.1	2.7	240.	1.	75.	Very slight black deposit

soluble by Franklin and Kraus but as being insoluble by Gore. But, in any case, the solubility of the iodide is too small for the purpose in hand. The solubility of cadmium acetate was not given in the paper by Franklin and Kraus, but qualitative tests indicated that it, like cadmium iodide, is slightly soluble.

Instead of preparing anhydrous cadmium nitrate, which is unstable and difficult of preparation, the ammino-derivative which, according to G. André,<sup>1</sup> is probably  $\text{Cd}(\text{NH}_3)_6(\text{NO}_3)_2$ , was prepared in the same manner as was the nickel salt except that the temperature at which it was heated was about  $80^\circ\text{C}$ .

The deposits made from neutral solutions were very poor. Acid solutions, made by the addition of 0.5, 1.0, and 1.5 grams of ammonium nitrate, gave better deposits and improved as the acidity increased. The best deposits obtained were those from solutions containing 10 grams of ammonium nitrate per 100 c.c. of liquid ammonia.

By far the greater number of experiments were carried out using iron cathodes. The best deposits obtained at the boiling point of the liquid ammonia solution were good in all respects except that they were not adherent. It occurred to us that the adherence of the deposits might be increased by carrying out the electrolyses at room temperature and under the higher pressure corresponding to that temperature. This is what might be expected from aqueous solutions. To this end, a bomb, which has been described previously, was constructed which permitted the electrolyses to be carried out under the above conditions.

A series of experiments were also carried out, using copper as the cathode, in order to determine whether or not pre-coating the iron with copper would increase the adherence of the deposits.

The results of thirty-eight electrolyses are found in Table III. The cadmium salt used was the hexammino nitrate previously described.

A summary of the influence of the various factors upon the form of the deposited cadmium follows.

1. Variation of Current Density.—In each of the above series it was observed that an increased current density gives a better deposit up to a certain value, above which the deposit becomes poorer in quality. For instance, at room temperature the current density at which the best deposit was obtained was 0.74 amp./sq. dm, above and below which the deposits were poorer. Also at the boiling point of liquid ammonia with a solution containing 8 gms. of salt per 100 c.c. of liquid ammonia, the best deposit was obtained at a current density of 1.15 amp./sq. dm, the deposits becoming poorer as the current density was increased or decreased.

2. Variation of Metal Ion Concentration.—As with the current density, an increase in the metal concentration gives a better deposit up to a maximum concentration above which the deposit becomes poorer. The concentration giving the best deposit was eight grams of the cadmium salt per 100 c.c. of liquid ammonia.

<sup>1</sup> Comp. rend., 104, 989 (1885).

TABLE III  
Cadmium Nitrate

Cell No.	Cathode	Anode	Solute Gms. per 100c.c. $\text{NH}_3$	Current Density amps./sq. dm.	Potential Drop volts	Coulombs from Current	Cathode Efficiency %	Anode Efficiency %	Description of Deposit
3	Fe	Cd	6	.5	.13	810	100.	123.	Rough, bright, uniformly distributed Not as rough as Cell #3; peels off on bending cathode
1	Fe	Cd	6	.8	.2	816	99.	119.	
a	Fe	Cd	6	1.2	.3	810	99.	108.	Smoother than Cell #1—not adherent More pitted than Cell a; rough along edges Slightly pitted; rough on edges; some met. dep. on reverse side
a	Fe	Cd	6	1.5	.4	819	99.	112.	
5	Fe	Cd	6	1.5	.4	816	98.	113.	
7	Fe	Cd	6	2.1	.5	810	95.	109.	Not uniform; smooth areas that were adherent
4	Fe	Cd	8	.5	.1	810	101.	112.	Uniform; unburnt; non-adherent; took high polish
2	Fe	Cd	8	.9	.2	816	99.	107.	Similar to Cell #4; reverse side was blistered
b	Fe	Cd	8	1.2	.3	810	99.	105.	Good deposit but non-adherent Similar to Cell b. Similar to cell b Somewhat more burnt and pitted than Cell b
10	Fe	Cd	8	1.4	.34	819	99.	105.	
6	Fe	Cd	8	1.6	.5	816	98.	104.	
8	Fe	Cd	8	2.	.6	810	97.	104.	
3'	Cu	Cd	6	.4	.1	720	55.	129.	Not uniform; pitted, but adherent
7'	Cu	Cd	6	.9	.2	567	96.	184.	Uniform, unburnt, grainy, and adherent
1'	Cu	Cd	6	1.2	.3	828	96.	105.	Same as Cell 7'
5'	Cu	Cd	6	1.6	.4	720	97.	239.	Somewhat smoother than Cell 7'
4'	Cu	Cd	8	.5	.1	720	107.	140.	Same as Cell 7'
8'	Cu	Cd	8	.9	.2	720	95.	108.	Same as Cell 7'
2'	Cu	Cd	8	1.2	.3	828	97.	120.	Somewhat smoother than Cell 8
6'	Cu	Cd	8	1.9	.4	720	96.	250.	Rough along edges



TABLE III (Continued)

Cell No.	Cathode	Anode	Solute Gms. per 100 c.c. $\text{NH}_3$	Current Density amps./sq. dm.	Potential Drop volts	Cadmium Nitrate		Description of Deposit		
						Coulombs from Current	Anode Efficiency %			
Series 2										
f	Fe	Cd	2	.3	1.2	.4	810	93.	109.	Not uniform; loose, and burnt
e	Fe	Cd	3	.3	1.1	.35	810	94.	116.	Mostly burnt; a small bright area present
d	Fe	Cd	4	.3	1.3	.3	828	97.	108.	Two thirds burnt; remainder bright, grainy, but non-adherent
c	Fe	Cd	5	.3	1.1	.3	828	98.	114.	Uniform, bright, grainy, non-adherent. Edges rough
Series 3										
g	Fe	Cd	10	.3	1.1	.3	810	95.	111.	Same as Cell c, edges smooth
h	Fe	Cd	12	.3	1.1	.3	810	95.	123.	Grainier than Cell g
Series 3										
17	Fe	Cd	8	.1	.5	.2	720	70.	134.	Uniform, grainy and non-adherent
19	Fe	Cd	8	.15	.7	.1	567	98.	113.	Uniform, smooth and adherent
16	Fe	Cd	8	.22	1.4	.4	884	81.	114.	Somewhat grainier than Cell 19
15	Fe	Cd	8	.3	1.5	.5	810	88.	123.	Unburnt and non-adherent. Some treeing
18	Fe	Cd	8	.4	1.8	.9	720	90.	127.	Similar to Cell 15
Series 4										
H	Fe	Cd	.5	.05	.2	.4	150	102.	129.	Badly burnt, grainy and non-adherent
I	Fe	Cd	"1.	.05	.2	.3	150	105.	138.	Same as Cell H
J	Fe	Cd	"1.5	.05	.2	.2	150	102.	127.	Smooother than Cell H
Series 5										
11	Fe	Cd	.1	.3	1.3	.4	828	110.	119.	Uniform, bright and non-adherent
12	Fe	Cd	.2	.3	1.2	.4	828	110.	115.	Similar to Cell 11
13	Fe	Cd	.4	.3	1.2	.3	810	98.	110.	The best of this series
14	Fe	Cd	.6	.3	1.2	.3	810	98.	106.	Similar to Cell 11
Series 1	+10 gms. of $\text{NH}_4\text{NO}_3$ /100 c.c.								Series 4	Contains 2 gm. cadmium salt; ammonium nitrate varies
Series 2	Cadmium salt only								Series 5	Contains 8 gm. cadmium salt; 10 gms. ammonium nitrate, casein varies
Series 3	Cadmium salt only; electrolyses at room temperature									

3. **Variation of Acidity.**—An examination of the description of the deposits in Cells H, I and J shows that each of the deposits was badly burnt, grainy and non-adherent. The general character, however, improves with increasing acidity. These experiments cannot be compared with those in which the solutions were made acid with ten grams of ammonium nitrate, since the metal concentrations and current densities were higher in the latter. There is no doubt, however, that the increased acidity gives a much better deposit.

4. **Effect of Change of Anion.** Some qualitative experiments were carried out using cadmium acetate, but its solubility is so small that only very poor deposits were obtained.

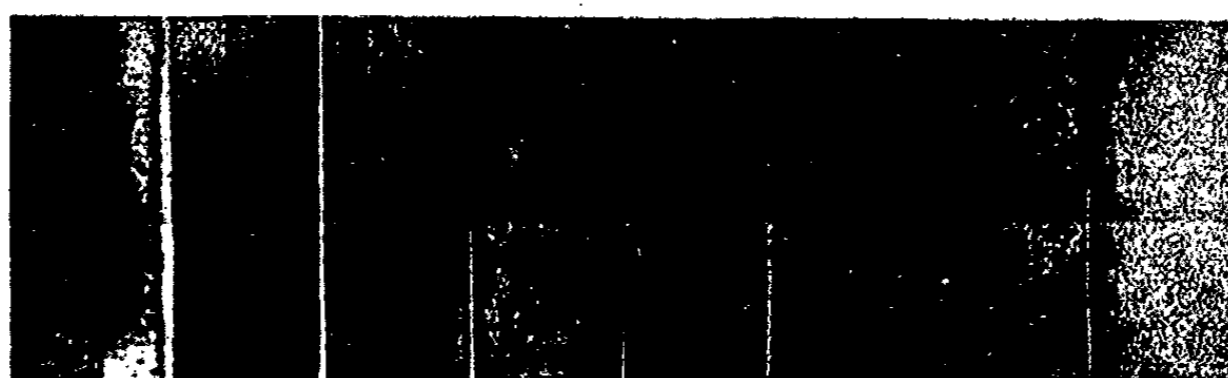

FIG. 4  
Deposits of Cadmium  $\times \frac{1}{2}$   
From left to right, cathodes from cells f, e, d, c, a, b, g, h, Table III, respectively.

5. **Variation of Temperature and Pressure.** When electrolyses were carried out using iron cathodes under conditions, excepting pressure and temperature, which otherwise gave the best deposit, namely, with a solution containing 8 grams of salt and 10 grams of ammonium nitrate per 100 c.c. of liquid ammonia and electrolyzed with a current of 0.3 amp., the following observations were made

(1) That adherent deposits were obtained.

(2) That increased pressure and temperature (together) tended to decrease the current density giving the best deposit.

6. **Effect of Base Metal.** It will be noted that deposits on copper were less grainy and very much more adherent than when iron cathodes were used. Cf. the two sets of cells in Series 1.

7. **Addition of Casein to Bath.** The effect of adding casein may be summarized as follows:

(a) The colloid, when added to a solution which otherwise gives the best deposit, tends to make the deposit become poorer.

(b) In any case, when added it makes the deposited metal film less tenacious.

(c) The deposits on the reverse of the cathodes, when casein is used, are more grainy and less adherent than in the case when no casein is used.

Throughout the experiments with cadmium salts, the anode current efficiencies were high. When it was seen that the efficiency increased with time,

a blank was run to determine whether or not cadmium metal was dissolved by liquid ammonia when an electric current was not flowing. A sample of liquid ammonia, which had been in contact with metallic cadmium for some time, was evaporated, the residue was dissolved in a little dilute nitric acid, and hydrogen sulfide was passed through it. The characteristic yellow CdS precipitate indicated the presence of cadmium.

#### Solutions of Copper Salts in Liquid Ammonia

Franklin and Kraus give the following cupric salts as being soluble in liquid ammonia:

Cupric acetate.....	slightly soluble
Cupric ammonium chloride.....	slightly soluble
Cupric formate.....	slightly soluble
Cupric nitrate.....	very easily soluble

Because of its high solubility and the relative ease in forming the anhydrous ammino-derivative, the last named salt was used in the experiments with copper. The anhydrous ammino-salt was prepared in the same manner as were those of nickel and cadmium. The temperature at which the copper derivative was heated was approximately 40°C. Like the salts of nickel and cadmium, it is relatively stable. According to D. W. Horn,<sup>1</sup> this salt corresponds to the formula  $\text{Cu}(\text{NH}_4)_3(\text{NO}_3)_2$ .

When neutral solutions of this copper salt were electrolyzed, it was found that the cathode current efficiency was small—under certain conditions no metal at all was deposited—that a perfectly white curdy precipitate was formed as the process continued, and that, in some cases, there was no gassing to form low current efficiency. It was observed that the precipitate was very unstable and changed rapidly into a brownish substance when exposed even for a brief time to the air. Some of it was obtained in a dry condition, by washing it repeatedly with liquid ammonia and drying out of contact with air. In the time at our disposal we did not feel warranted in making an analysis of this product, as special apparatus and methods would be required in order to carry out the analysis in the absence of air. When electrolyses of neutral solutions are made out of contact with air, no precipitate is formed; but when air is permitted to come in contact with solutions which have been electrolyzed for a time, the precipitate is formed immediately. The formation of this precipitate, therefore, must have been due to a reaction between some constituent of the air and some substance formed during the electrolysis of the solutions. Experiments were carried out in an atmosphere of nitrogen, water, and oxygen respectively. No precipitate was formed when nitrogen and water were used, but when oxygen was introduced, after electrolysis had continued for some time, the precipitate came down at once. It is to be observed that the oxygen has no influence upon the solution before, but must

<sup>1</sup> Am. Chem. J., 37, 620 (1907).

react with some substance formed during electrolysis. That the precipitate is a cuprous compound is shown by its decolorizing potassium permanganate solution and upon its ready oxidation by air.

The results of twenty-five electrolyses are recorded in Table IV. The solute in all cases was the tetraammino nitrate as previously described. In the last sixteen trials five grams of ammonium nitrate was added to every hundred cubic cm. of liquid ammonia in addition to the copper salt.

These results may be briefly summarized as follows.

1. Variation of Current Density. Although there was no case in which a good deposit was obtained, due to the fact that all were non-adherent, increasing the current density improves the deposit up to a certain point beyond which it becomes poorer.

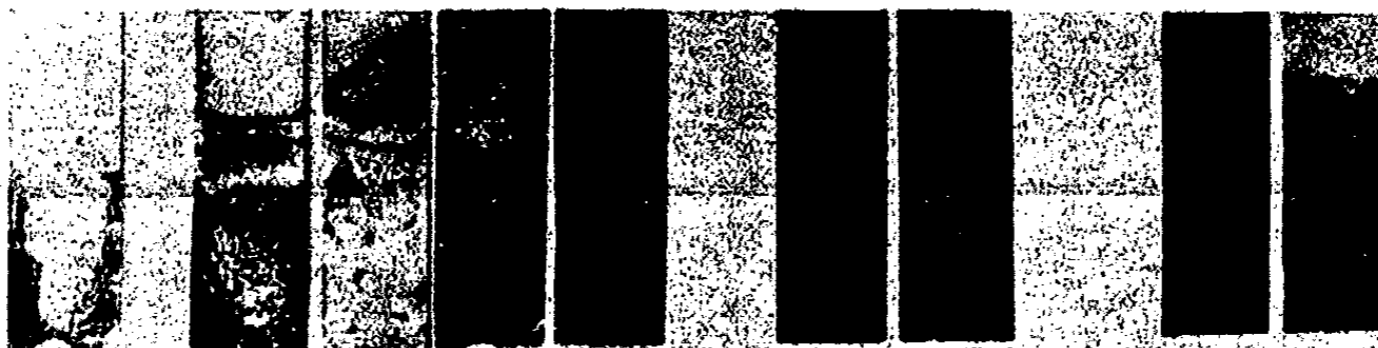

FIG. 5  
Deposits of Copper  $\times \frac{1}{2}$   
From left to right, cathodes from cells Nos. 1, 2, 3, 4, 5, 8, 9, 6, and 7, Table IV

2. Effect of Change of Metal Concentration. The effect of a change in metal concentration, other conditions being the same, is to increase the permissible current density with decreasing metal concentration. However, too much reliance cannot be placed on these conclusions since there was difficulty in interpreting the deposits.

3. Effect of Change in Hydrogen Ion Concentration. The best deposits obtained under either acid or neutral conditions cannot be called good, since in no case were they adherent. However, the addition of 5 grams of acid to 100 c.c. of solution gave deposits which were better in every respect with the exception of adherence, in which they were all about the same in case of the best deposits.

#### Solutions of Silver Salts in Liquid Ammonia

Silver nitrate contains no water of crystallization and, therefore, was chosen to be used in the electrolysis of silver solutions. Deposits formed from neutral, basic, and acid solutions were not good; the poorest were obtained from the neutral solutions, slightly better from basic solutions, and still better from acid solutions. Silver nitrate solutions were made basic by the addition of sodamide and acid by the addition of ammonium nitrate. The deposits from neutral solutions were all badly burnt and in only a few cases could be polished to the bright metal. Basic and acid solutions gave burnt deposits, but in a number of cases could be polished to the bright metal; the

TABLE IV  
Copper Nitrate

Cell No.	Cathode	Anode	Solute gms/100 c.c. NH <sub>3</sub>	Current Amperes	Current Density amp/sq. dm.	Potential Drop volts	Coulombs Calc. from Current	Cathode Efficiency %	Anode Efficiency %	Description of Deposit	
1'	Fe	Cu	4	.7	0.1					Dark and flaky	
2'	Fe	Cu	2	1.1	0.2					Dark and flaky	
3'	Fe	Cu	3	1.1	0.2					Small amount of blue deposit	
4'	Fe	Cu	4	1.3	0.2					Uneven, bright and fairly adherent	
5'	Fe	Cu	8	1.1	0.2					No deposit	
6'	Fe	Cu	4	2.	0.4					Bright, smooth, uneven—not very adherent	
7'	Fe	Cu	8	2.	0.4					Bright, rough, uneven, and non-adherent	
8'	Fe	Cu	4	3.7	0.6					Bright, rough, uneven and non-adherent	
9'	Fe	Cu	8	3.7	0.6					Bright, rough, uneven, and non-adherent	
			+ 5 gm. NH <sub>4</sub> NO <sub>3</sub>								
3	Fe	Cu	4	1.3	0.3	1.	720	22.	320.	Not uniform, smooth, bright and not very adherent	
1	Fe	Cu	4	1.7	0.4	1.1	720	28.	312.	Similar to above	
5	Fe	Cu	4	1.9	0.5	1.3	720	29.	295.	Uniform, bright, smooth, but not very adherent	
7	Fe	Cu	4	2.3	0.6	1.4	720	42.	264.	Similar to above	
9	Fe	Cu	4	3.4	0.8	1.9	720	45.	240.	Less adherent than Cell 5	
15	Fe	Cu	4	4.6	1.	2.3	1800	49.	205.	Fine-grained, brittle and non-adherent	
11	Fe	Cu	4	5.6	1.4	3.2	2100	54.	188.	Uneven, smooth and non-adherent	
13	Fe	Cu	4	8.6	2.	7.5	2040	47.	187.	Similar to Cell 11	
4	Fe	Cu	6	1.3	0.3	0.9	720	7.	378.	Similar to Cell 11	
2	Fe	Cu	6	1.6	0.4	1.	720	19.	332.	Similar to Cell 11	
6	Fe	Cu	6	2.1	0.5	1.3	720	22.	295.	Smooth, brittle, and non-adherent	
8	Fe	Cu	6	2.7	0.6	1.9	720	45.	240.	Smooth, brittle, and non-adherent	
10	Fe	Cu	6	3.3	0.8	1.6	720	36.	260.	Smooth, brittle, and non-adherent	
16	Fe	Cu	6	4.5	1.	2.2	1800	47.	213.	Somewhat rougher than Cell 6	
12	Fe	Cu	6	6.	1.4	2.7	2100	56.	197.	Somewhat rougher than Cell 6	
14	Fe	Cu	6	2.	8.9	6.7	2040	47.	187.	Poorer deposit than Cell 16	

TABLE V

Cell No.	Cathode	Anode	Gms. per 100c.c. NH <sub>3</sub>		Current Amperes	Current Density smps./Sq.dm.	Silver Nitrate		Cathode Efficiency %	Anode Efficiency %	Description of deposit
			AgNO <sub>3</sub>	NaCN			Poten-tial Drop volts	Cou-lombs calc. from Current			
5	Fe	Ag	2	1.2	0.05	0.2	1.	90	98.	Burnt, bright, brittle and non-adherent	
1	Fe	Ag	2	1.2	0.1	0.4	0.8	180.	97.	Same as Cell 5	
3	Fe	Ag	2	1.2	0.3	1.1	2.5	162.	103.	Dark, amorphous, easily rubbed off; Deposit on back side fine grained and adherent	
7	Fe	Ag	2	1.2	0.5	2.	4.4	259	100.	Same as Cell 3	
6	Fe	Ag	4	2.4	0.05	0.2	0.8	90	93.	Same as Cell 3	
2	Fe	Ag	4	2.4	0.1	0.4	0.8	180	99.	Bright, smooth, tough but not adherent	
4	Fe	Ag	4	2.4	0.3	1.1	2.	162	101.	Same as Cell 2	
8	Fe	Ag	4	2.4	0.5	1.9	3.8	259	101.	Coating of dark material as in Cell 3	
9	Fe	Ag	6	2.4	0.5	1.1	1.8	270	96.	Bright, brittle and non-adherent	
10	Fe	Ag	8	4.8	0.3	1.2	1.7	270	95.	Bright, brittle and non-adherent	

metal films were pitted, brittle, and non-adherent. In all three types of solutions, the iron cathodes turned dark immediately upon closing the circuit which was probably responsible for the lack of adherence. The use of copper cathodes gave more adherent deposits but they were still brittle.

Sodium cyanide seems to react with the silver salt in liquid ammonia to form a complex ion as it does in aqueous solutions for, with its use, bright deposits were obtained without any difficulty.

The results of some typical electrolyses are given in Table V.



FIG. 6  
Deposits of Silver,  $\times \frac{1}{2}$   
From left to right, cathodes from cells Nos. 5, 6, 1, 2, 3, 4, 7, 8, 9, and 10, Table V

It will be noticed that a variation of the current density yields, as in previous cases, a better deposit at a certain critical current density. Above and below this value the deposits are poorer in quality.

The effect of changing the concentration of the salt is noticeable.

In case of the solutions containing 2 grams of silver nitrate, none of them—neglecting the factor of adherence—could be called good; the solution containing 4 grams per 100 c.c. of liquid ammonia gave the best deposit; a further increase in the metal concentration, at the same current density, gave poorer deposits. An increase in metal concentration, then, increases the permissible current density giving a good deposit.



FIG. 7  
Deposits of Zinc,  $\times \frac{1}{2}$   
From left to right, cathodes from cells Nos. 3, 4, 1, 2, 5, 6, 7, 8, 9, and 10, Table VI

#### Solutions of Zinc Salts in Liquid Ammonia

Several observations of zinc deposits from liquid ammonia solutions were made. The salt used was zinc nitrate, hexahydrate, iron being employed as the cathode and zinc strips as the anode. The results of these electrolyses are given in Table VI.

TABLE VI  
 Zinc Nitrate

Cell No.	Cathode	Anode	Solute gms/100 cc. NH <sub>4</sub>	Current amperes	Current Density amp/sq/dm	Potential Drop volts	Description of deposits
3	Fe	Zn	4	0.1	0.4	1.	Layer of dark amorphous deposit; polished down to layer of bright metal
4	Fe	Zn	Saturated	0.1	0.4	.5	Same as Cell 3
1	Fe	Zn	4	0.3	1.1	3.	Not uniform; brittle and not adherent
2	Fe	Zn	Saturated	0.3	1.2	1.5	Bright, smooth, fine grained and adherent
5	Fe	Zn	4	0.5	2.1	4.7	Not uniform, very brittle and non-adherent
6	Fe	Zn	Saturated	0.5	2.4	2.2	Similar to Cell 5
7	Fe	Zn	Saturated	0.3	1.9	0.8	Bright, smooth and adherent
8	Fe	Zn	+2 gm. NH <sub>4</sub> NO <sub>3</sub> Saturated	0.3	1.2	0.6	Same as Cell 7, but grainier
9	Fe	Zn	+4gm. NH <sub>4</sub> NO <sub>3</sub> Saturated	0.3	1.3	0.5	Same as Cell 7, but grainier
10	Fe	Zn	+6gm. NH <sub>4</sub> NO <sub>3</sub> Saturated	0.3	1.3	0.4	Same as Cell 7, but grainier
			+8gm. NH <sub>4</sub> NO <sub>3</sub>				



Conclusions similar to those already drawn in the case of other metals, with respect to the influence of changing current density, metal salt concentration, and acidity can be made here.

#### Solutions of Chromium Salts in Liquid Ammonia

Chromium chloride and chromic acid were the only salts given by Franklin and Kraus as being at all soluble and they are only slightly soluble. Several other compounds were tried with the following results:

$\text{Cr}_2(\text{PO}_4)_2 \cdot 6\text{H}_2\text{O}$	Insoluble
$\text{Cr}_2(\text{C}_2\text{H}_3\text{O}_2)_6 \cdot 2\text{H}_2\text{O}$	Slightly soluble
$\text{Cr}_2(\text{SO}_4)_3 \cdot 5\text{H}_2\text{O}$	Insoluble
$\text{KCr}(\text{SO}_4)_2 \cdot 12\text{H}_2\text{O}$	Insoluble
$\text{ZnCrO}_4$	Insoluble
$(\text{NH}_4)_2\text{Cr}_2\text{O}_7$	Slightly soluble
$\text{K}_2\text{Cr}_2\text{O}_7$	Slightly soluble
$\text{K}_2\text{CrO}_4$	Insoluble
$\text{Cr}(\text{NO}_3)_3 \cdot x\text{H}_2\text{O}$	Very slightly soluble

#### Effect of the Addition of $\text{NaNH}_2$ on the Solubility of Chromium Salts

$\text{Cr}_2(\text{PO}_4)_2 \cdot 6\text{H}_2\text{O}$	Slight coloration
$\text{Cr}_2(\text{SO}_4)_3 \cdot 5\text{H}_2\text{O}$	No coloration
$\text{Cr}(\text{NO}_3)_3 \cdot x\text{H}_2\text{O}$	Very slight coloration
$\text{Cr}_2(\text{C}_2\text{H}_3\text{O}_2)_6 \cdot 2\text{H}_2\text{O}$	No detectable change
$\text{K}_2\text{CrO}_4$	No coloration
$\text{CrO}_3$	No detectable change

Rather a large number of experiments were carried out with various chromium salts, chromium acetate and chromic acid, in particular, all with negative results. The attempt was made to duplicate the conditions under which chromium deposits are produced in aqueous solutions—that is, by the use of chromic acid solution containing a small quantity of a salt whose anion is not decomposed in the process, such as the sulphate or chloride,—but the best that could be obtained was a black, non-adherent, amorphous coating. The great difficulty lay, no doubt, in the solubility of the salts available. The cell whose conductivity was the greatest was that in which a current of 0.3 amp. was passed under a potential of 110 volts.

#### Solutions of Aluminum Salts in Liquid Ammonia

Aluminum nitrate, which was found to be very soluble in liquid ammonia, was employed in neutral, basic, and acid solutions in the attempt to obtain an aluminum deposit. There was no case in which there was the slightest deposit but gassing always occurred at both electrodes.

Cryolite was found to be insoluble.

#### Summary and Conclusions

To illustrate how changes in the operating conditions alter the form of deposits made in liquid ammonia solutions, specific examples for each variable previously outlined may be given.

1. Increase in Current Density. A nickel solution containing 2 grams of hexammino-nickel nitrate per 100 c.c. of liquid ammonia, gave the best deposit (Table II, #9) at a current density of 0.15 amps./sq. dm. The deposit at a lower current density, 0.07 amps./sq. dm. was somewhat darkened (Table II, #8) and at a higher current density, 0.23 amps./sq. dm., it was covered with green colored growths (Table II, #10).

This factor was more marked in its effect upon silver deposits. A solution containing 4 grams of silver nitrate per 100 c.c. of liquid ammonia gave, at a current density of 0.42 amps./sq. dm., the best deposit in this group (Table V, #2) but at 0.21 amps./sq.dm., it was partly burnt and torn away from the electrodes (Table V, #6), and at 1.85 amps./sq.dm., it was badly burnt (Table V, #8).

Cells 1, 2 and 3 (Table I) of the lead deposits, formed from a normal solution of lead nitrate, show that as the current density increases, the size of the nodules decreases and the area covered by the deposit increases. There was also some treeing along the electrode of Cell 3; Although the lead deposits given above were not good, it is evident that increased current density favors a good deposit up to the point where treeing occurs.

2. Lowering of the Temperature. Lead deposits of Cells 5 and 6 were prepared under the same conditions as were those of Cells 1 and 4 except that the former were obtained at lower temperatures, namely: at  $-55^{\circ}$  and  $-57^{\circ}\text{C}$  respectively. If there is any difference in the form of the corresponding deposits, it is in the size of the nodules; the area covered by the deposit has not been noticeably changed. It seems, therefore, that lowering the temperature has only a slight effect upon the form of the deposit.

3. Addition of Colloidal Materials to Solution. When the colloidal material gliadin was added to a solution identical with that used to form the lead deposit of Cell 7 and electrolyzed at the same current density, no difference between the deposits could be detected (Cell 13.) The above result, together with the similarity between these deposits and those made from aqueous solutions containing colloids, had lead us to believe that neutral solutions of lead nitrate in liquid ammonia contain a colloidal basic salt which exerts a like effect upon deposits made in liquid ammonia solutions.

The addition of casein in varying quantities to a solution of the same composition as was used to form deposit of Cell #b, Table III, electrolyses made at approximately the same current density, causes the deposits (Table III, #11, #12, #14) produced to be of poorer quality in that the film is less tenacious and the grainy character increased.

Since very little is known about the behavior of colloids in liquid ammonia, it was not possible to choose intelligently among the colloidal materials which are soluble in liquid ammonia, for one which would be carried toward the cathode in the course of electrodeposition. For this reason any beneficial effect upon deposits caused by the addition of colloidal material to liquid ammonia solutions would be entirely accidental, since these substances were chosen at random.

4. Increase in Metal Salt Concentration. A series of cadmium deposits made at a current density of approximately 1.15 amps./sq.dm. from a solution containing 10 grams of ammonium nitrate and variable quantities of the hexammino salt can be selected from Table III. A solution containing 8 grams gave the best deposit, (#b), another with 2 grams (#F) formed a "spongy" and "arboreal" deposit, and one with 12 grams gave a deposit possessing a distinct grainy character.

Deposits #1 and #2 of Table III from solutions containing respectively 4 and approximately 8 (saturated) grams of zinc nitrate hexahydrate per 100 c.c. of liquid ammonia show a pronounced effect due to difference in metal concentration. #1 was brittle, burnt, and non-adherent, while #2 was tough, bright, and adherent.

5. Increase in Conductivity of Solution. Lead deposits of Cells 7 and 8, Table I, show how the effect of increased conductivity, effected by the addition of 1 gram of ammonium nitrate to one of two identical solutions, alters the deposit. In Cell 7 large ridges or striations consisting of nodule-like growths of acicular crystals, have grown out into the solution. In Cell 8 the striations are not present, the tendency to grow out into the solution has decreased and, although they are larger, the nodules are much closer together.

Cells #2, #7, #8, #9 and #10 of Table VI represent deposits from solutions containing 4 grams of zinc nitrate hexahydrate per 100 c.c. of liquid ammonia and 0, 2, 4, 6, and 8 grams respectively of ammonium nitrate. The deposit in Cell #2 was bright and adherent over most of the electrode but the film was less tenacious than Cell #7. As the acidity increases from 2 to 8 grams, the deposits become more grainy.

6. Agitation. Deposits in Cells #17 and 18, Table I, were made under the same conditions as that of Cell 8, except that for the first two the solutions were stirred. The base metal for Cell 17 was lead and iron for Cell 18. The effect of stirring was to eliminate the growths, forming a smooth, adherent film.

### Conclusions

Our purpose in this investigation, as mentioned in the introduction, was threefold: (1) To determine if the same general factors influence the form of metals deposited from liquid ammonia as from aqueous baths, (2) the influence of the solvent upon deposits, and (3) the possibility of commercial utilization. As to the first point, ample confirmation has been given in the discussion hitherto given. In the case of the second objective, direct comparisons are difficult to make in all cases. For this purpose we have prepared a table of deposits made in aqueous and in liquid ammonia baths.

From the table of comparison of deposits made in aqueous and liquid ammonia solutions, it appears that the effect of the solvent upon deposits is as follows:

1. In the majority of cases the C.D. for the best deposit is lower in liquid ammonia solutions than in aqueous solutions. They are, however, about the same for silver and zinc.

TABLE VII  
Conditions for the Formation of "Best" Deposits

Factor	Pb		Ni		Cd		Cu		Ag		Zn	
	NH <sub>3</sub>	H <sub>2</sub> O	NH <sub>3</sub>	H <sub>2</sub> O	NH <sub>3</sub>	H <sub>2</sub> O	NH <sub>3</sub>	H <sub>2</sub> O	NH <sub>3</sub>	H <sub>2</sub> O	NH <sub>3</sub>	H <sub>2</sub> O
Metal base	Fe	—	Ni	—	Fe	—	Fe	—	Fe	—	Fe	—
C.D. in amps.	0.61	1-2	0.15	0.5-1.0	1.21	0.5-2	3.3	6	0.42	0.43-54	1.9	1.5-3
Normality	1	1 <sup>1</sup>	0.14	0.9 <sup>3</sup>	.5	.5 <sup>5</sup>	0.5	1.5 <sup>7-2</sup>	0.23	.22 <sup>9</sup>	.53	2.5 <sup>10</sup>
Acidity in gms. per 100 c.c. of solvent	1.0	—	0	1.5 <sup>4</sup>	10	A <sup>6</sup> .5	5	6 <sup>8</sup>	0	0	2	2 <sup>11</sup>
Addition of Colloids	No	Yes <sup>2</sup>	No	No	No	Yes	No	Yes	No	No	No	Yes
Agitation	Yes	Yes	No	No	No	—	No	Yes	No	—	No	—
Temperature	B.P.S. <sup>12</sup>	B.P.S.	20-30°	B.P.S.	R	B.P.S.	25°	B.P.S.	17-23°	B.P.S.	—	—

<sup>1</sup> Fluoborate solution

<sup>2</sup> Glue

<sup>3</sup> Single salt solution

<sup>4</sup> H<sub>2</sub>BO<sub>3</sub>

<sup>5</sup> Cyanide bath

<sup>6</sup> NaOH

<sup>7</sup> Acid bath

<sup>8</sup> H<sub>2</sub>SO<sub>4</sub>

<sup>9</sup> Cyanide bath

<sup>10</sup> Acid bath

<sup>11</sup> HC<sub>2</sub>H<sub>3</sub>O<sub>2</sub>

<sup>12</sup> Boiling point of Ammonia

\* The data for aqueous solutions were taken from "Principles of Electroplating and Electroforming" by Blum and Hogaboom. This data are not necessarily for the best deposits obtainable but simply for "good" deposits.

2. For three metals, Pb, Cd, and Ag, the metal concentrations were approximately the same; for the other three, the concentrations were lower in liquid ammonia solutions.

The difference between the two solvents are apparently due chiefly to the much greater fluidities of solutions in liquid ammonia. Thus, Fitzgerald<sup>1</sup> gives approximately 340 as the fluidity of .5N  $\text{CuNO}_3 \cdot 4\text{NH}_3$  at  $-33.5^\circ$  in liquid ammonia, while Blanchard<sup>2</sup> found for the corresponding salt at  $25^\circ$  in water a fluidity of less than half this value; for the corresponding silver salt the fluidity is reduced nearly one third in aqueous solutions over that in liquid ammonia solutions. Furthermore, Franklin and Cady<sup>3</sup> in their work on ionic velocities in liquid ammonia at  $-33^\circ$  found that the ionic velocities are two and one half to three times greater than in water at  $18^\circ$ .

No data are available for the temperature coefficients of viscosity of liquid ammonia solutions, but if the differences (which are slight) in the form of the lead deposits obtained by us at  $-33^\circ\text{C}$  and at  $-57^\circ\text{C}$  are accountable solely to change in viscosity the temperature coefficient of viscosity of solutions in liquid ammonia must be very much less than that in water, which is generally given as 2% per degree.

The difficulties involved in preparing good lead and cadmium deposits in aqueous solutions, such as cost and adequate control of rather complex plating baths, make it seem at least possible that electrodeposition of these metals from their liquid ammonia solutions may find a practical application in industry.

<sup>1</sup> J. Phys. Chem., 16, 644 (1912).

<sup>2</sup> J. Am. Chem. Soc., 26, 1324 (1904).

<sup>3</sup> J. Am. Chem. Soc., 26, 499 (1904).

## INFLUENCE OF TEMPERATURE ON THE COAGULATION OF SOLS, AND THE PROBLEM OF ACCLIMATISATION OF ANIMALS

BY N. R. DHAR AND SATYA PRAKASH

In publications<sup>1</sup> from these laboratories we are trying to throw light on the problem of old age and acclimatisation. We have advanced the view that old age is associated with marked decrease in the catalytic activity of the body enzymes and cells. Consequently in old age there is an appreciable decrease in the metabolism of the animal body. Observations on the metabolism of human beings of different ages show that the metabolism expressed per square metre or kilogram is less in old age than in childhood or youth. Animal life is assumed to depend essentially on the activity of the cells or the enzymes. We have tried to prove that the phenomenon of ageing is common both to inorganic and organic colloids and precipitates. We<sup>2</sup> have shown that the activity, adsorptive power, stability, and viscosity of hydrophobe colloids, in general, decrease and electric conductivity increases with time. On the other hand, with hydrophile colloids the viscosity and the amount of hydration increases up to a limiting value, while the electric conductivity decreases on ageing. We have recently shown that colloids can be divided into two classes according to their behavior on exposure to light. Thus sols of ferric hydroxide, chromium hydroxide, zirconium hydroxide, ceric hydroxide, vanadium pentoxide, arsenious sulphide and manganese dioxide become less stable on exposure to light. On the other hand, sols of Prussian blue, cupric ferrocyanide, mastic, and gum dammar are stabilised when exposed to light.

In this communication we are recording the results obtained on the influence of temperature on the coagulation of sols.

The coagulation of several sols was investigated by placing the sol and the electrolyte in thermostats at constant temperature. The following results were obtained:—

### Ferric Hydroxide ( $\text{Fe}(\text{OH})_3$ )

In order to prepare ferric hydroxide sol small quantities of ammonium carbonate were added to a concentrated solution of ferric chloride, till the precipitate of ferric hydroxide redissolved. The sol was dialysed for six weeks.

TABLE I

Concentration of sol = 26.745 grms. of  $\text{Fe}_2\text{O}_3$  per litre.

Amount of sol taken each time = 2 c.c.

Total volume = 10 c.c.; Time = 1 hour.

Electrolyte	Amount to coagulate in c.c.	
	at 20°C	at 60°C
Potassium chloride N/5	1.1	0.90
Potassium chloride N/100	1.4	1.15

<sup>1</sup> Dhar: J. Phys. Chem., 30, 378, 480 (1926).

<sup>2</sup> Z. anorg. allgem. Chem., 162, 237; 168, 209 (1927); Kolloid-Z., 42, 120 (1927).

**Cupric Ferrocyanide Sol**

Dilute solutions of cupric sulphate and potassium ferrocyanide were mixed, potassium ferrocyanide being in slight excess and the mixture was dialysed for 10 days, with occasional stirring.

TABLE II

Concentration of sol = 3.1 gm. per litre.  
Amount of sol taken each time = 2 c.c. (A-sol); 1 c.c. (A/2-sol).  
Total volume = 10 c.c.; Time = 1 hour.

Electrolyte	Amount to coagulate in c.c.			
	A sol		A/2 sol	
	at 30°C.	at 60°C.	at 30°C.	at 60°C.
Potassium chloride N/4	3.2	2.0	3.5	2.4
Barium chloride N/200	1.7	1.25	1.9	1.2
Hydrochloric acid N/4	2.6	2.0	2.7	2.25

**Prussian Blue Sol**

In order to prepare Prussian blue sol dilute solutions of ferric chloride and potassium chloride and potassium ferrocyanide were carefully mixed and a small quantity of ammonium oxalate was added as a peptising agent. This mixture was subject to dialysis for twelve days and a clear deep blue sol of Prussian blue was obtained.

TABLE III

Concentration of the sol = 9.33 gms. per litre.  
Amount of sol taken each time = 1 c.c. (A-sol); 0.5 c.c. (A/2-sol).  
Total volume = 10 c.c.; Time = 1 hour.

Electrolyte	Amount to coagulate in c.c.			
	A sol.		A/2 sol.	
	at 30°C.	at 60°C.	at 30°C.	at 60°C.
Potassium chloride N/4	2.45	2.95	3.1	3.5
Barium chloride N/200	2.3	2.0	1.9	1.85
Hydrochloric acid N/4	—	—	2.1	0.4

**Vanadium Pentoxide**

The sol was prepared by taking finely powdered ammonium vanadate in a mortar, to which a concentrated solution of hydrochloric acid was added slowly till no more of red vanadic acid precipitated. The precipitate was allowed to settle and the clear liquid was decanted. The precipitate was washed three or four times by decantation with distilled water in order to free it from ammonium chloride. At this stage, the precipitate has a tendency to pass into the colloidal state. The precipitate was now vigorously shaken in a coloured glass bottle with distilled water and a clear, deep-red coloured sol of vanadium pentoxide was obtained.

TABLE IV

Concentration of the sol = 3.64 grms.  $V_2O_5$  per litre.  
 Amount of sol taken each time = 1 c.c. (A-sol); 0.5 c.c. (A/2-sol).  
 Total volume = 10 c.c.; Time = 1 hour.

Electrolyte	Amount to coagulate in c.c.			
	A sol		A/2 sol.	
	at 30°C.	at 60°C.	at 30°C.	at 60°C.
Potassium chloride N/10	0.95	0.75	0.8	0.65
Barium chloride N/500	1.35	0.95	1.15	0.70
Aluminium nitrate N/2000	1.3	0.95	0.8	0.55

#### Stannic Hydroxide Sol

Stannic hydroxide was precipitated by the action of an excess of ammonium hydroxide on stannic chloride solution. The precipitate on washing once or twice with water passes into a negatively charged, clear sol, which was purified by dialysis.

TABLE V

Concentration of the sol = 6.66 grms. of  $SnO_2$  per litre.  
 Amount of sol taken each time = 1 c.c.  
 Total volume = 10 c.c.; Time = 1 hour.

Electrolyte	Amount to coagulate in c.c.	
	at 30°C.	at 60°C.
Potassium chloride N/4	2.4	1.4
Barium chloride N/200	1.1	0.85

#### Zirconium Hydroxide Sol (in hot)

A solution of zirconium nitrate was boiled vigorously for half an hour and was dialysed for 10 days and a clear sol was obtained.

TABLE VI

Concentration of the sol = 9.56 grms. of  $ZrO_2$  per litre.  
 Amount of sol taken each time = 2 c.c. (A-sol); 1 c.c. (A/2 sol).  
 Total volume = 10 c.c.; Time = 1 hour.

Electrolyte	Amount to coagulate in c.c.			
	A-sol.		A/2 sol.	
	at 30°C.	at 60°C.	at 30°C.	at 60°C.
Potassium chloride N/4	1.1	0.4	1.5	0.7
Potassium sulphate N/200	1.9	1.55	—	—

#### Zirconium Hydroxide Sol (in cold)

A clear aqueous solution of zirconium nitrate prepared at the ordinary temperature was dialysed for 10 days and a clear sol was obtained.



TABLE VII

Concentration of the sol = 9.42 grams. of  $ZrO_2$  per litre.  
 Amount of sol taken each time = 2 c.c. (A-sol); 1 c.c. (A/2 sol).  
 Total volume = 10 c.c.; Time = 1 hour.

Electrolyte	Amount to coagulate in c.c.			
	A sol		A/2 sol.	
	At 30°C.	at 60°C.	at 30°C.	at 60°C.
Potassium chloride N/4	1.9	0.9	1.8	0.95
Sodium citrate 0.0032 M	2.0	1.6	1.3	1.2

#### Aluminium Hydroxide Sol

A solution of aluminium nitrate containing an excess of sodium acetate was dialysed for 20 days. A clear dilute sol of aluminium hydroxide was obtained.

TABLE XIII

Concentration of the sol = 1.32 grms. of  $Al_2O_3$  per litre.  
 Amount of sol taken each time = 4 c.c. (A-sol); 2 c.c. (A/2-sol).  
 Total volume = 10 c.c.; Time = 1 hour.

Electrolyte	Amount to coagulate in c.c.			
	A - sol.		A/2 sol.	
	at 30°C.	at 60°C.	at 30°C.	at 60°C.
Sodium citrate 0.0159 M	0.8	0.6	0.4	0.4
Sodium tartrate 0.019 M	0.9	0.9	0.5	0.5

#### Chromium Hydroxide Sol

This sol was prepared by the action of ammonium carbonate on a solution of chromium-tri-chloride, till the precipitate of chromium hydroxide formed redissolved. The sol was allowed to dialyse for 17 days.

TABLE IX

Concentration of the sol = 1.725 grms. of  $Cr_2O_3$  per litre.  
 Amount of sol taken each time = 2 c.c. (A-sol); 1 c.c. (A/2 sol).  
 Total volume = 10 c.c.; Time = 1 hour.

Electrolyte	Amount to coagulate in c.c.			
	A sol		A/2 sol	
	at 30°C.	at 60°C.	at 30°C.	at 60°C.
Potassium sulphate N/200	3.7	3.4	2.6	2.1
Sodium citrate 0.0032 M	1.2	1.1	0.75	0.65

#### Ceric Hydroxide Sol

25 grms. of ceric-ammonium nitrate were dissolved in 250 c.c. of water at 25°C. The solution was dialysed for 6 days after filtering.

TABLE X

Concentration of the sol = 17.65 grms. of  $\text{CeO}_2$  per litre.  
 Volume of the mixture = 10 c.c.  
 Amount of sol taken each time = 1 c.c.  
 Time = 1 hour.

Electrolyte	Amount to coagulate in c.c.	
	at 30°C.	at 60°C.
Potassium chloride N/4	4.8	1.1
Potassium sulphate N/200	1.4	1.4

#### Arsenious Sulphide Sol

The sol was prepared by passing a slow current of  $\text{H}_2\text{S}$  in a solution of arsenious oxide, the excess of  $\text{H}_2\text{S}$  was removed by passing hydrogen.

TABLE XI

Concentration of sol = 26.73 grms. of  $\text{As}_2\text{S}_3$  per litre.  
 Amount of sol taken each time = 2 c.c.  
 Total volume = 10 c.c. Time = 1 hour.

Electrolyte	Amount to coagulate in c.c.		
	at 30°C.	at 60°	at 80°C.
Potassium chloride N/4	2.6	2.6	8.2
Barium chloride N/50	1.2	1.1	0.9
Sulphuric acid 0.65/N	1.05	1.05	1.35

#### Sheep Serum

Fresh sheep-blood was taken in a bottle in which it formed a firm clot within a few minutes. After a short time, syneresis took place and straw coloured clear serum was squeezed out, which was used for the experiments. 6 c.c. of serum on heating on a water bath for 2 hours left a residue of 3.4 grms.

TABLE XII

Amount of serum taken each time = 2 c.c.  
 Volume = 10 c.c.; Time = 1 hour.

Electrolyte	Amount to coagulate in c.c.	
	at 30°C.	at 60°C.
Hydrochloric acid N/100	3.55	4.35
Sulphuric acid	2.80	3.25
Oxalic acid N/100	3.3	3.50
Acetic acid N/50	1.9	2.3
Potassium fluoride 8N	1.85	1.9
Sodium tartrate 1.91 M	7.15	7.1

#### Dammar Resin Sol

A concentrated solution of dammar resin was prepared in alcohol. The alcoholic solution was poured into distilled water, and the sol thus obtained was dialysed for seven days.

TABLE XIII

Concentration of the sol = 4.44 grms. per litre.

Amount of sol taken each time = 1 c.c.

Total volume = 5 c.c.; Time = 1 hour.

Electrolyte	Amount to coagulate in c.c.		
	At 30°C.	at 60°C.	at 70°C.
Potassium chloride N/8	1.1	1.3	1.5
Barium chloride N/8	0.55	0.65	—
Hydrochloric acid	1.7	0.55	0.8

**Gamboge Sol**

A concentrated alcoholic solution of gamboge was poured into distilled water, and the sol thus obtained was dialysed for a week.

TABLE XIV

Concentration of the sol = 7.92 grams. per litre.

Amount of sol taken each time = 1 c.c.

Total volume = 10 c.c.; Time = 1 hour.

Electrolyte	Amount to coagulate in c.c.		
	At 30°C.	at 40°C.	at 50°C.
Potassium chloride N	4.2	4.30	4.45
Barium chloride N/8	1.0	1.20	1.30
Hydrochloric acid N/100	3.1	3.05	2.9
Tartaric acid N/10	3.6	—	3.4
Oxalic acid N/10	1.3	—	1.15

**Mastic Sol**

A concentrated alcoholic solution of mastic was prepared and poured into distilled water. The sol thus obtained was dialysed for a week.

TABLE XV

Amount to coagulate in c.c.

Electrolyte	Amount to coagulate in c.c.	
	at 30°C.	at 50°C.
Potassium chloride N	1.2	1.4
Barium chloride N/4	0.75	0.9
Hydrochloric acid N/100	1.2	0.95

The foregoing experimental results show that sols of ferric hydroxide, stannic hydroxide, zirconium hydroxide, (prepared in the hot and cold conditions), aluminium hydroxide, chromium hydroxide, cerium hydroxide, and cupric ferrocyanide require smaller quantities of electrolytes when coagulated at higher temperatures than at 30°. In other words, the above sols become more aged and unstable when kept at higher temperatures. On the other hand, gamboge, gum dammar, mastic, and sheep serum become more stable against coagula at higher temperatures.

We have shown that sols of ferric hydroxide, chromium hydroxide, aluminium hydroxide, stannic hydroxide, zirconium hydroxide, and cerium hydroxide become less stable towards electrolytes even when kept at the ordinary temperature, hence our experimental results show that as far as these sols are concerned the influence of temperature leads to the accentuation of the time effect. These sols become unstable more readily when kept at a higher temperature than at the ordinary.

We<sup>1</sup> have definitely shown that sols of mastic, gum dammar, gamboge, sheep serum, etc. are hydrolysed and the stability of these sols towards electrolytes increases with the degree of hydrolysis. At higher temperatures these sols become more hydrolysed and their stability is also increased at higher temperatures. In presence of acids the hydrolysis of these sols is greatly suppressed and the stability is decreased, hence in the coagulation of these sols by acids at higher temperatures, small quantities of acids are required.

In the case of Prussian blue, the sol becomes more stable towards potassium chloride at higher temperatures, whilst it becomes less stable towards barium chloride and hydrochloric acid. It appears that cupric ferrocyanide becomes decomposed at higher temperatures and requires smaller quantities of electrolytes for coagulation.

In a previous communication<sup>2</sup> we have applied Stefan's law of radiation in explaining the increase in metabolism observed when the surrounding temperature of a warm-blooded animal is lowered. We have advanced the view that the effect of transportation of a warm-blooded animal from a comparatively warmer climate to a very cold climate will be to activate the enzymes and cells in the body and it will lead to the shortening of the life of the animal. On the other hand, the transportation of a warm-blooded animal from a very cold climate to a comparatively warm country is to cause the body cells and enzymes to work at a slower speed and the life of the animal may be prolonged by this transportation.

It is well known that cold-blooded animals live much longer than warm-blooded animals of the same size because the catalytic activity of the cells and the enzymes present in cold-blooded animals is not as great as those in warm-blooded animals. When a cold-blooded animal living in a warm country is taken to a cold country the metabolism will decrease and the animal leads a life of less intensity and greater duration. On the other hand, by the transportation of a cold-blooded animal from a cold to a warm country, the catalytic activity of the cells and enzymes is increased. This leads to a shortening of the life period of the animal.

From our experiments on the coagulation of sols it will be observed that the stability of several colloids decreases considerably by increasing the temperature of the colloid, and the colloids will age more rapidly. Conse-

<sup>1</sup> J. Phys. Chem., 30, 830 (1926); Kolloid-Z., 39, 346 (1926).

<sup>2</sup> J. Phys. Chem., 30, 480 (1926).

quently the colloids present in cold-blooded animals will have longer duration of healthy life, and this leads to the greater longevity of the animals themselves.

The body temperature of warm-blooded animals is normally much higher than the surrounding air. In the case of some birds, sparrow, hen, etc., the body temperature is about  $42^{\circ}$ , in the case of rabbit  $39.6^{\circ}$  and in the case of a dog it is  $39.2^{\circ}$ . It will be clear from the results published in the foregoing pages that several body colloids cells and enzymes present in these animals will age readily and become unstable at these moderately high temperatures. Moreover these cells and catalysts are made to work at a high speed in order to make up for the heat lost by radiation and other sources. Consequently the longevity of these warm-blooded animals cannot be as high as that of cold-blooded animals.

Voit gives the following results on the influence of temperature on the metabolism of a fasting man.

Temp:—	$4.4^{\circ}$	$6.5^{\circ}$	$9^{\circ}$	$14.3^{\circ}$	$16.2^{\circ}$	$24.2^{\circ}$	$26.2^{\circ}$	$30^{\circ}$
CO <sub>2</sub> excreted								
in grms.	210.7	206.0	192.0	155.1	158.3	166.5	160.0	170.6

It appears from the above results that when the outside temperature is about  $15^{\circ}$  the metabolism of the animal body is the minimum. Similar results showing that the metabolism is minimum when the external temperature is about  $15^{\circ}$  have been obtained with other warm-blooded animals. We are of the opinion that the longevity of an animal is increased if the body cells and enzymes are made to work at a minimum speed. Moreover at the temperature  $15^{\circ}$  the body colloids do not age rapidly, hence this temperature is the most suitable one for the healthy life of warm-blooded animals which maintain a higher body temperature than the surrounding air. People living in a country under suitable hygienic conditions should have the maximum longevity, if the average temperature is near about  $15^{\circ}$ .

#### Summary

(1) Sols of ferric hydroxide, chromic hydroxide, vanadium pentoxide, aluminium hydroxide, stannic hydroxide, zirconium hydroxide, ceric hydroxide and cupric ferrocyanide require smaller quantities of electrolytes when coagulated at  $60^{\circ}$  than the amounts required for coagulation at  $30^{\circ}$ .

(2) The amounts of salts required to coagulate sols of dammarresin, mastic, gamboge, prussian blue and sheep serum at  $40^{\circ}$ ,  $50^{\circ}$ ,  $60^{\circ}$  and  $70^{\circ}$  are greater than those required at  $30^{\circ}$ . When the coagulation is effected by hydrochloric acid, the amounts of acid necessary are smaller, the higher the temperature. These results can be explained from the view-point of the hydrolysis of these sols.

(3) Increase of temperature accentuates the ageing of these sols.

(4) An explanation has been advanced for the greater longevity of cold blooded animals than warm-blooded ones of the same size.

(5) People living under hygienic conditions in a country having an average temperature  $15^{\circ}$  should have the maximum longevity, because when the outside temperature is about  $15^{\circ}$ , the metabolism in warm-blooded animals seems minimum.

*Chemical Laboratory,  
Allahabad University,  
Allahabad, India.  
Sept. 13, 1928.*

### SOLUTIONS FOR COLORIMETRIC STANDARDS. III

#### 6-969. Observations on the Color of Inorganic Substances in Organic and Inorganic Solvents

BY M. G. MELLON AND VIOLET FOSTER

Individuals who have worked with solutions as possible permanent standards of color have felt the need of a wider range of hues from which to make their selections. There is a sufficient variety of yellows and greens in the central region of the spectrum; but, on moving out from this portion of it, there seems to be little choice in the direction of either the red or the violet end. The dominant wave lengths of the few that are available in these regions are not sufficiently removed toward the respective ends to meet some of the requirements. Furthermore, of the hues that are available not all can be used for mixing with each other to make intermediate blends on account of the difficulties encountered when some of the solutions react with each other.

The first two papers of this series<sup>1</sup> dealt, in part, with colorimetric measurements on certain solutions which had already been used as standards of color. The purpose of the present one is to report the results of a preliminary search for solutions less subject than those previously used to the limitations mentioned above.

In an earlier paper<sup>2</sup> mention was made regarding what seemed to be some of the solutions possibly available as standards of color, among which were non-aqueous solutions of salts of the color-forming elements. A preliminary search in this direction was started, therefore, with the hope of finding some solutions of promise for further observation. For the sake of comparison certain other solutions, particularly those proposed by Army,<sup>1</sup> were included in the series investigated.

There have been reported already various studies involving solutions of inorganic substances in organic solvents.<sup>3</sup> For the most part these investi-

<sup>1</sup> Mellon and Martin: *J. Phys. Chem.*, 31, 161 (1927); Mellon: 33, 1931 (1929).

<sup>2</sup> Mellon: *Proc. Indiana Acad. Sci.*, 32, 164 (1922).

<sup>3</sup> Benrath: *Z. physik. Chem.*, 74, 115 (1910); Berthelot and Gaudechon: *Compt. rend.*, 152, 376 (1911); Boll: *Ann. Phys.*, (9) 2, 54, 266 (1914); Bourgoïn: *Bull. Soc. Chim. Belg.*, 33, 101 (1924); de Bruyn: *Z. physik. Chem.*, 10, 782 (1892); Ber., 26, 268 (1893); Carter: *Ind. Eng. Chem.*, 18, 827 (1926); Curtis and Burns: *J. Am. Chem. Soc.*, 39, 33 (1917); Davidson: 50, 1890 (1928); Eidmann: *Chem. Zentr.*, 1899n, 1014; Ellis and Wells: *Chemical Action of Ultraviolet Rays*, 132 (1925); Etard: *Compt. rend.*, 114, 112 (1892); Forcrand: 102, 551 (1886); Getman: *J. Am. Chem. Soc.*, 50, 2883 (1928); Hantzsch: *Z. physik. Chem.*, 72, 362 (1910); Hantzsch and Robertson: Ber., 41, 4328 (1908); Herz and Knoch: *Z. anorg. Chem.*, 41, 315 (1904); 45, 262, 46, 193 (1905); Herz and Kuhn: 60, 152 (1908); Hulburt and Hutchinson: *Carnegie Inst. Wash. Pub.* 260, 6 (1918); Jones and Anderson: *Carnegie Inst. Wash. Pub.*, 110 (1909); Jones and Guy: 190 (1913); Jones and Strong: 130 (1910); 160 (1911); Klepl: *J. prakt. Chem.*, (2) 25, 526 (1882); Klever: *Bull.* 18, 372 (1872); Krug and McElroy: *J. anal. Chem.*, 6, 184 (1892); von Laszcynski: Ber., 27, 2285 (1894); Malmy: *J. pharm. chim.*, (8) 4, 111 (1926); Mathews and Dewey: 8th Int. Congr. Appl. Chem., 20, 247 (1912); *J. Phys. Chem.*, 17, 211 (1913); Naumann: Ber., 32, 999 (1899); 37, 3600, 4238, 4609 (1904); 42, 3789 (1909); 43, 313 (1910); 47, 247, 1369 (1914); Ossendovsky: *J. Russ. Phys. Chem. Soc.*, 7, 1071 (1906); Plotnikow: *Bull. Acad. Sci. Russ.*, 1919, 1093; Puxeddo: *Gazz.*, 50L, 153 (1920); 59, 160 (1929); Retgers: *Z. anorg. Chem.*, 3, 252 (1893); Rideal and Norrish: *Proc. Roy. Soc.*, 103A, 342 (1923); Ross: *J. Am. Chem. Soc.*, 28, 790 (1906); Russell and Orsman: *Chem. News*, 59, 93 (1889); Sachs: Ber., 34, 497 (1901); Schiff: *Ann.*, 118, 365 (1861); Simon: *J. prakt. Chem.*, (2) 20, 371 (1879); Stuckgold: *J. Chim. phys.*, 15, 505 (1917); Timofejew: *Compt. rend.*, 112, 1223 (1891); Urbain and Scal: 168, 887 (1919); Wood: *Phil. Mag.*, 41, 423 (1896).

gations have dealt with colorless solutions with the major emphasis on the solubility relationships of the various systems, particularly as compared with those for aqueous solutions of the same solutes, and on the chemical properties of the solutions, such as the nature of the reactions likely to occur therein. Some colored solutions are included, of course, in the list of those studied. Occasional mention is found also regarding the hue of some solution, its stability on standing, or its reaction toward ultraviolet radiation.

#### Experimental Data

In this investigation two points were kept in mind as being of primary interest. The first involved the question of what the actual color of the solution would be, its hue being in this instance perhaps the most important of the several attributes of the color. The second involved the question of the permanency of the color. To answer the former, at least qualitatively, it was necessary only to prepare the solution and to observe its color; while in the latter case the period of observation had to be more or less extended, either allowing time for any spontaneous reaction likely to produce fading, or controlling conditions so as to accelerate the process.

Not all the inorganic solutes used were subjected to an equally careful preparation. Cupric sulfate and ferric, cobaltous, and aquo-pentamminocobaltic chlorides were purified for earlier work.<sup>1</sup> The following salts were recrystallized at least once from water redistilled from potassium permanganate and barium hydroxide: potassium bichromate, potassium chromate, nickelous nitrate hexahydrate, nickelous chloride (uncertain hydration), nickelous sulfate heptahydrate, cupric chloride dihydrate, cupric nitrate hexahydrate, cupric bromide, and cobaltous nitrate hexahydrate. Chromic sulfate, vanadium pentoxide, and iodine were used as purchased.

The solvents were purchased from the Eastman Kodak Co., C. A. F. Kahlbaum, or the Mallinckrodt Chemical Co. In the following cases further purification was attempted according to the directions found in the references noted; ethyl alcohol,<sup>4</sup> carbon tetrachloride,<sup>5</sup> phenyl bromide,<sup>5</sup> and chloroform.<sup>6</sup> After shaking with mercury, the carbon disulfide was allowed to stand a short time in the presence of a fat (butter) and then redistilled, according to the directions of Bohm. Constant boiling-point hydrochloric acid was prepared in the usual manner. The acidified or ammoniacal water contained the amounts of acid or base recommended by Arny.<sup>1</sup>

In preparing the solutions some of the solute was simply stirred into the solvent in a beaker, heating, if necessary, to hasten the process of solution, until the color attained a brilliance judged to be approximately that of a fifth-molar aqueous solution of cupric sulfate. No effort was made to have the preparation quantitative as it was desired merely to ascertain whether an amount of solute would dissolve to give a color with a workable brilliancy. In some cases apparently none of the material dissolved, judged by the

<sup>1</sup> Stewart and Aston: *J. Am. Chem. Soc.*, **48**, 1646 (1926).

<sup>5</sup> Williams and Krchma: *J. Am. Chem. Soc.*, **48**, 1890 (1926).

<sup>6</sup> Lueck: *J. Am. Chem. Soc.*, **44**, 760 (1922).



absence of color in the solvent after boiling in contact with the material. In others an amount dissolved too small to give a solution of any ordinary colorimetric use.

After preparing the solutions as indicated, each was divided into four parts of about 15 ml. each. Three of these were immediately sealed up in test tubes of soft glass (by drawing the glass off, as in a Carius tube) except in the case of ammoniacal solutions where Pyrex tubes were used. The fourth, before being sealed up in the same way, was transferred to a vessel of fused quartz, stoppered, and placed close to a quartz mercury arc lamp (Cooper Hewitt type designed for operation at four amperes and 220 volts) in order to determine the effect of exposing the solution to this source of ultraviolet radiation for two hours. The following disposal was then made of the four tubes sealed up for each solution: one was immediately placed in the dark and kept there as a check; a second was placed on the wall of a laboratory in order to expose the solution continuously to the ordinary light of the laboratory, but without permitting any direct sunlight to fall on the tube; a third was placed close to a window of the laboratory having a southern exposure in such a position that any available sunlight would fall on the tube containing the solution; and a fourth, following its period of irradiation, was placed on the wall of the laboratory close to the second. All tubes were kept in the dark from the time of their preparation until the entire group was ready for exposure in order to have the conditions, particularly the sunlight, the same for all solutions. Observations, in addition to those at the time of irradiation, were made on all tubes at the end of six and twelve months.

*Hue of Solutions.* There was no attempt to make a colorimetric analysis of these solutions in order to designate the dominant wave length of the hue since earlier calculations had indicated that the hue of some solutions, at least, is a function of the concentration. Descriptive terms were deemed sufficient in this case. The hues of the various combinations, as observed at the time of preparation, are indicated in Table I.

TABLE I  
Hue and Stability of Various Solutions

Solute	Original Hue	Laboratory Light	Effect of Exposure Ultraviolet Radn.	Sun light
CH <sub>3</sub> OH as Solvent				
Ni(NO <sub>3</sub> ) <sub>2</sub> ·6H <sub>2</sub> O	green	no change	no change	no change
NiCl <sub>2</sub> ·xH <sub>2</sub> O	green	no change	no change	no change
NiSO <sub>4</sub> ·7H <sub>2</sub> O	green	no change	no change	paler + grn. res.
Cu(NO <sub>3</sub> ) <sub>2</sub> ·6H <sub>2</sub> O	blue	no change	some light res.	some dark res.
CuCl <sub>2</sub> ·2H <sub>2</sub> O	ylsh. green	no change	no change	cls. + dark res.
CuBr <sub>2</sub>	amber	no change	no change	cls. + light res.
Co(NO <sub>3</sub> ) <sub>2</sub> ·6H <sub>2</sub> O	red	no change	no change	some brown res.
CoCl <sub>2</sub> ·6H <sub>2</sub> O	magenta	no change	no change	no change
FeCl <sub>3</sub>	yellow	colorless	colorless	colorless
I <sub>2</sub>	amber	no change	paler	no change

TABLE I (Continued)  
Hue and Stability of Various Solutions

Solute	Original Hue	Laboratory Light	Effect of Exposure Ultraviolet Radn.	Sun Light
<b>C<sub>2</sub>H<sub>5</sub>OH as Solvent</b>				
Ni(NO <sub>3</sub> ) <sub>2</sub> ·6H <sub>2</sub> O	green	no change	no change	no change
NiCl <sub>2</sub> ·xH <sub>2</sub> O	green	no change	no change	some yellow res.
Cu(NO <sub>3</sub> ) <sub>2</sub> ·6H <sub>2</sub> O	blue	light res.	light res.	res. of Cu (?)
CuCl <sub>2</sub> ·2H <sub>2</sub> O	ylsh. green	light res.	light res.	colorless
CuBr <sub>2</sub>	amber	dark res.	dark res.	cls. + yellow res.
Co(NO <sub>3</sub> ) <sub>2</sub> ·6H <sub>2</sub> O	red	no change	some brown res.	paler + brown res.
CoCl <sub>2</sub> ·6H <sub>2</sub> O	blue	no change	no change	some light res.
FeCl <sub>3</sub>	yellow	colorless	colorless	colorless
I <sub>2</sub>	amber	no change	no change	no change
<b>n-C<sub>2</sub>H<sub>5</sub>OH as Solvent</b>				
Ni(NO <sub>3</sub> ) <sub>2</sub> ·6H <sub>2</sub> O	green	no change	no change	no change
NiCl <sub>2</sub> ·xH <sub>2</sub> O	green	no change	no change	no change
Cu(NO <sub>3</sub> ) <sub>2</sub> ·6H <sub>2</sub> O	blue	some light res.	some light res.	more res.
CuCl <sub>2</sub> ·2H <sub>2</sub> O	ylsh. green	cls. + light res.	cls. + light res.	cls. + light res.
CuBr <sub>2</sub>	amber	no change	no change	cls. + light res.
Co(NO <sub>3</sub> ) <sub>2</sub> ·6H <sub>2</sub> O	red	no change	brownish	paler + brown res.
CoCl <sub>2</sub> ·6H <sub>2</sub> O	blue	no change	no change	some light res.
FeCl <sub>3</sub>	yellow	pale yellow	colorless	colorless
I <sub>2</sub>	amber	no change	no change	colorless
<b>n-C<sub>4</sub>H<sub>9</sub>OH as Solvent</b>				
Ni(NO <sub>3</sub> ) <sub>2</sub> ·6H <sub>2</sub> O	green	no change	no change	no change
NiCl <sub>2</sub> ·xH <sub>2</sub> O	green	no change	no change	no change
Cu(NO <sub>3</sub> ) <sub>2</sub> ·6H <sub>2</sub> O	blue	some res.	greenish res.	amber + res.
CuCl <sub>2</sub> ·2H <sub>2</sub> O	ylsh. green	colorless	nearly cls.	cls. + dark res.
CuBr <sub>2</sub>	amber	cls. + light res.	cls. + light res.	cls. + light res.
Co(NO <sub>3</sub> ) <sub>2</sub> ·6H <sub>2</sub> O	red	no change	no change	paler + brown res.
CoCl <sub>2</sub> ·6H <sub>2</sub> O	blue	no change	no change	no change
FeCl <sub>3</sub>	yellow	pale yellow	colorless	colorless
I <sub>2</sub>	amber	more reddish	colorless	colorless
<b>C<sub>2</sub>H<sub>4</sub>(OH)<sub>2</sub> as Solvent</b>				
K <sub>2</sub> CrO <sub>4</sub>	yellow	green (Cr <sup>'''</sup> )	green (Cr <sup>'''</sup> )	green (Cr <sup>'''</sup> )
K <sub>2</sub> Cr <sub>2</sub> O <sub>7</sub>	yellow	green (Cr <sup>'''</sup> )	green (Cr <sup>'''</sup> )	green (Cr <sup>'''</sup> )
CrCl <sub>3</sub>	green	no change	no change	no change
Ni(NO <sub>3</sub> ) <sub>2</sub> ·6H <sub>2</sub> O	green	no change	slightly yls.	no change
NiCl <sub>2</sub> ·xH <sub>2</sub> O	green	no change	no change	no change
NiSO <sub>4</sub> ·7H <sub>2</sub> O	green	no change	no change	no change
CuCl <sub>2</sub> ·2H <sub>2</sub> O	green	no change	no change	cls. + dark res.
Cu(NO <sub>3</sub> ) <sub>2</sub> ·6H <sub>2</sub> O	green	no change	no change	some reddish res.
CuSO <sub>4</sub> ·5H <sub>2</sub> O	grnsh. blue	no change	some res.	some res. (Cu?)
CuBr <sub>2</sub>	amber	paler	paler	paler + light res.
Co(NO <sub>3</sub> ) <sub>2</sub> ·6H <sub>2</sub> O	red	no change	brownish	no change
CoCl <sub>2</sub> ·6H <sub>2</sub> O	purple	no change	no change	no change
Co(NH <sub>3</sub> ) <sub>5</sub> H <sub>2</sub> OCl <sub>2</sub>	pale red	nearly cls.	slightly yls.	more yellowish
FeCl <sub>3</sub>	yellow	paler	still paler	colorless
I <sub>2</sub>	amber	no change	no change	no change

TABLE I (Continued)  
Hue and Stability of Various Solutions

Solute	Original Hue	Laboratory Light	Effect of Exposure Ultraviolet Radn.	Sun Light
$C_2H_5(OH)_2$ as Solvent				
$K_2CrO_4$	yellow	green (Cr'')	green (Cr''')	green (Cr''')
$K_2Cr_2O_7$	amber	green (Cr'')	green (Cr''')	green (Cr''')
$CrCl_3$	green	green res.	green res.	green res.
$Ni(NO_3)_2 \cdot 6H_2O$	green	no change	no change	no change
$NiCl_2 \cdot xH_2O$	green	no change	no change	no change
$NiSO_4 \cdot 7H_2O$	green	no change	no change	no change
$Cu(NO_3)_2 \cdot 6H_2O$	grnsh. blue	some res. (Cu?)	some res. (Cu?)	more res. (Cu?)
$CuCl_2 \cdot 2H_2O$	green	no change	no change	cls. + dark res.
$CuSO_4 \cdot 5H_2O$	blue	no change	some res. (Cu?)	paler + res. (Cu?)
$CuBr_2$	grnsh. yellow	no change	no change	paler + light res.
$Co(NO_3)_2 \cdot 6H_2O$	red	no change	no change	no change
$CoCl_2 \cdot 6H_2O$	red	no change	no change	no change
$FeCl_3$	yellow	colorless	colorless	colorless
$I_2$	amber	no change	paler	no change
$CH_3COOC_2H_5$ as Solvent				
$Ni(NO_3)_2 \cdot 6H_2O$	green	no change	paler + grnsh. res.	paler + grnsh. res.
$Cu(NO_3)_2 \cdot 6H_2O$	blue	no change	no change	grnsh. res.
$CuCl_2 \cdot 2H_2O$	green	ylsh. green	paler + light res.	cls. + dark res.
$CuBr_2$	grnsh. amber	no change	paler + dark res.	cls. + light res.
$Co(NO_3)_2 \cdot 6H_2O$	red	some res.	light res.	paler + brown res.
$CoCl_2 \cdot 6H_2O$	blue	light res.	light res.	light res.
$FeCl_3$	yellow	paler	paler	cls. + light res.
$I_2$	amber	no change	paler	no change
$n\text{-}CH_3COOC_2H_5$ as Solvent				
$Ni(NO_3)_2 \cdot 6H_2O$	green	no change	no change	no change
$Cu(NO_3)_2 \cdot 6H_2O$	blue	no change	grnsh. res.	grnsh. res.
$CuCl_2 \cdot 2H_2O$	grnsh. yellow	cls. + light res.	cls. + light res.	cls. + dark res.
$CuBr_2$	green	light res.	cls. + light res.	cls. + light res.
$Co(NH_4)_2H_2OCl_2$	red	less purple	paler + some res.	nearly cls. + res.
$FeCl_3$	yellow	cls. + light res.	cls. + light res.	cls. + light res.
$I_2$	amber	no change	no change	no change
$CHCl_3$ as Solvent				
$FeCl_3$	yellow	nearly cls. + res.	nearly cls. + res.	nearly cls. + res.
$I_2$	red	no change	no change	some brown res.
$CCl_4$ as Solvent				
$I_2$	red	no change	yellowish	no change
$C_2H_5Br$ as Solvent				
$CuBr_2$	green	light res.	amber + res.	amber + res.
$FeCl_3$	yellow	amber	darker	paler + res.
$I_2$	amber	no change	light res.	paler + dark res.

TABLE I (Continued)  
Hue and Stability of Various Solutions

Solute	Original Hue	Laboratory Light	Effect of Exposure Ultraviolet Radn.	Sun Light
<b>C<sub>2</sub>H<sub>4</sub>Cl<sub>2</sub> as Solvent</b>				
FeCl <sub>3</sub>	yellow	amber + dark res.	light yellow	cls. + light res.
I <sub>2</sub>	red	no change	paler	no change
<b>C<sub>6</sub>H<sub>6</sub>Br as Solvent</b>				
FeCl <sub>3</sub>	yellow	darker	amber	darker
I <sub>2</sub>	red	paler	yellowish	darker + dark res.
<b>CS<sub>2</sub> as Solvent</b>				
FeCl <sub>3</sub>	yellow	darker	cloudy + dark res.	amber + dark res.
I <sub>2</sub>	red	no change	no change	some dark res.
<b>C<sub>6</sub>H<sub>5</sub>N as Solvent</b>				
Ni(NO <sub>3</sub> ) <sub>2</sub> ·6H <sub>2</sub> O	blue	blue crystals	amber + light res.	amber + light res.
CuCl <sub>2</sub> ·2H <sub>2</sub> O	blue	no change	amber	darker amber
CuBr <sub>2</sub>	green	no change	amber	amber + dark res.
Co(NO <sub>3</sub> ) <sub>2</sub> ·6H <sub>2</sub> O	red	reddish amber	amber	amber + res.
CoCl <sub>2</sub> ·6H <sub>2</sub> O	red	no change	brownish red	brownish red
FeCl <sub>3</sub>	amber	no change	darker	darker + dark res.
I <sub>2</sub>	yellow	amber	darker	amber
<b>CH<sub>3</sub>·CO·CH<sub>3</sub> as Solvent</b>				
Ni(NO <sub>3</sub> ) <sub>2</sub> ·6H <sub>2</sub> O	green	no change	paler + light res.	paler + light res.
Cu(NO <sub>3</sub> ) <sub>2</sub> ·6H <sub>2</sub> O	blue	greenish	grnsh. + dark res.	grnsh. + dark res.
CuCl <sub>2</sub> ·2H <sub>2</sub> O	grnsh. yellow	darker + res.	darker + res.	brown + dark res.
CuBr <sub>2</sub>	grnsh. yellow	paler + light res.	light res.	brown + dark res.
Co(NO <sub>3</sub> ) <sub>2</sub> ·6H <sub>2</sub> O	red	light res.	paler + brown res.	paler + brown res.
CoCl <sub>2</sub> ·6H <sub>2</sub> O	blue	no change	some res.	some res.
FeCl <sub>3</sub>	yellow	darker	darker	darker
I <sub>2</sub>	amber	darker	lighter	much darker
<b>CH<sub>3</sub>·COOH (glacial) as Solvent</b>				
K <sub>2</sub> CrO <sub>4</sub>	green	no change	no change	no change
K <sub>2</sub> Cr <sub>2</sub> O <sub>7</sub>	ylsh. green	greener	green	green + light res.
Ni(NO <sub>3</sub> ) <sub>2</sub> ·6H <sub>2</sub> O	green	no change	no change	paler + light res.
NiCl <sub>2</sub> ·xH <sub>2</sub> O	green	ylsh. green + res.	ylsh. green + res.	ylsh. green + res.
Cu(NO <sub>3</sub> ) <sub>2</sub> ·xH <sub>2</sub> O	grnsh. blue	no change	some light res.	some light res.
CuCl <sub>2</sub> ·2H <sub>2</sub> O	green	no change	some light res.	paler + dark res.
Co(NO <sub>3</sub> ) <sub>2</sub> ·6H <sub>2</sub> O	red	no change	no change	no change
CoCl <sub>2</sub> ·6H <sub>2</sub> O	blue	no change	no change	no change
FeCl <sub>3</sub>	yellow	no change	no change	cls. + light res.
I <sub>2</sub>	amber	darker	darker	darker
<b>H<sub>2</sub>O (acidified with HCl) as Solvent</b>				
K <sub>2</sub> CrO <sub>4</sub>	amber	no change	no change	no change
K <sub>2</sub> Cr <sub>2</sub> O <sub>7</sub>	orange	no change	no change	no change
Cr <sub>2</sub> (SO <sub>4</sub> ) <sub>3</sub>	green	bluish green	bluish green	bluish green
Ni(NO <sub>3</sub> ) <sub>2</sub> ·6H <sub>2</sub> O	green	no change	no change	no change
NiCl <sub>2</sub> ·xH <sub>2</sub> O	green	no change	no change	no change

TABLE I (Continued)  
Hue and Stability of Various Solutions

Solute	Original Hue	Laboratory Light	Effect of Exposure Ultraviolet Radn.	Sun Light
$\text{NiSO}_4 \cdot 7\text{H}_2\text{O}$	green	no change	no change	no change
$\text{Cu}(\text{NO}_3)_2 \cdot 6\text{H}_2\text{O}$	blue	no change	no change	no change
$\text{CuCl}_2 \cdot 2\text{H}_2\text{O}$	blue	no change	no change	no change
$\text{CuSO}_4 \cdot 5\text{H}_2\text{O}$	blue	no change	no change	no change
$\text{CuBr}_2$	blue	no change	no change	no change
$\text{Co}(\text{NO}_3)_2 \cdot 6\text{H}_2\text{O}$	red	no change	no change	no change
$\text{CoCl}_2 \cdot 6\text{H}_2\text{O}$	red	no change	no change	no change
$\text{FeCl}_3$	yellow	no change	no change	no change
<b><math>\text{H}_2\text{O}</math> (alkaline with <math>\text{NH}_4\text{OH}</math>) as Solvent</b>				
$\text{K}_2\text{Cr}_2\text{O}_7$	yellow	no change	no change	no change
$\text{Ni}(\text{NO}_3)_2 \cdot 6\text{H}_2\text{O}$	blue	no change	no change	paler + light res.
$\text{NiCl}_2 \cdot x\text{H}_2\text{O}$	blue	light res.	light res.	light res.
$\text{NiSO}_4 \cdot 7\text{H}_2\text{O}$	blue	light res.	light res.	paler + light res.
$\text{Cu}(\text{NO}_3)_2 \cdot 6\text{H}_2\text{O}$	blue	no change	no change	some light res.
$\text{CuCl}_2 \cdot 2\text{H}_2\text{O}$	blue	no change	no change	some light res.
$\text{CuSO}_4 \cdot 5\text{H}_2\text{O}$	blue	no change	some res.	some res.
$\text{CuBr}_2$	blue	no change	no change	no change
$\text{Co}(\text{NH}_3)_6\text{H}_2\text{OCl}_2$	red	no change	no change	some brown res.
<b><math>\text{H}_2\text{SO}_4</math> (concn.) as Solvent</b>				
$\text{K}_2\text{Cr}_2\text{O}_7$	yellow	greener	greener	green
$\text{CoCl}_2 \cdot 6\text{H}_2\text{O}$	red	no change	no change	no change
$\text{Co}(\text{NH}_3)_6\text{H}_2\text{OCl}_2$	red (pale)	no change	no change	more purplish
$\text{V}_2\text{O}_5$	yellow	no change	no change	no change
$\text{I}_2$	red (pale)	no change	much paler	no change
<b><math>\text{H}_3\text{PO}_4</math> (concn.) as Solvent</b>				
$\text{K}_2\text{Cr}_2\text{O}_7$	yellow	no change	no change	pale green
$\text{Ni}(\text{NO}_3)_2 \cdot 6\text{H}_2\text{O}$	green	no change	no change	no change
$\text{NiCl}_2 \cdot x\text{H}_2\text{O}$	green	no change	no change	no change
$\text{NiSO}_4 \cdot 7\text{H}_2\text{O}$	ylsh. green	no change	no change	no change
$\text{Cu}(\text{NO}_3)_2 \cdot 6\text{H}_2\text{O}$	blue	no change	no change	no change
$\text{CuCl}_2 \cdot 2\text{H}_2\text{O}$	blue	no change	no change	no change
$\text{CuSO}_4 \cdot 5\text{H}_2\text{O}$	blue	no change	no change	no change
$\text{Co}(\text{NO}_3)_2 \cdot 6\text{H}_2\text{O}$	red	no change	no change	no change
$\text{CoCl}_2 \cdot 6\text{H}_2\text{O}$	red	no change	no change	no change
$\text{Co}(\text{NH}_3)_6\text{H}_2\text{OCl}_2$	red (pale)	no change	no change	paler
$\text{V}_2\text{O}_5$	yellow	no change	no change	no change
<b><math>\text{HClO}_4</math> (concn.) as Solvent</b>				
$\text{K}_2\text{Cr}_2\text{O}_7$	yellow	no change	colorless	colorless
$\text{Ni}(\text{NO}_3)_2 \cdot 6\text{H}_2\text{O}$	green (pale)	no change	no change	no change
$\text{NiCl}_2 \cdot x\text{H}_2\text{O}$	ylsh. green	no change	no change	no change
$\text{NiSO}_4 \cdot 7\text{H}_2\text{O}$	green (pale)	no change	no change	no change
$\text{Cu}(\text{NO}_3)_2 \cdot 6\text{H}_2\text{O}$	blue	no change	no change	no change
$\text{CuCl}_2 \cdot 2\text{H}_2\text{O}$	blue	no change	no change	no change
$\text{CuSO}_4 \cdot 5\text{H}_2\text{O}$	blue	no change	no change	no change

TABLE I (Continued)  
 Hue and Stability of Various Solutions

Solute	Original Hue	Laboratory Light	Effect of Exposure Ultraviolet Radn.	Sun Light
CuBr <sub>2</sub>	yellow (pale)	no change	slightly blue	no change
Co(NO <sub>2</sub> ) <sub>2</sub> ·6H <sub>2</sub> O	red	no change	no change	no change
CoCl <sub>2</sub> ·6H <sub>2</sub> O	red	no change	no change	no change
FeCl <sub>3</sub>	yellow	lighter	lighter	colorless
V <sub>2</sub> O <sub>5</sub>	yellow	amber	amber	green
HCl (constant boiling point) as Solvent				
K <sub>2</sub> CrO <sub>4</sub>	orange	green (Cr <sup>'''</sup> )	green (Cr <sup>'''</sup> )	green (Cr <sup>'''</sup> )
K <sub>2</sub> Cr <sub>2</sub> O <sub>7</sub>	orange	green (Cr <sup>'''</sup> )	green (Cr <sup>'''</sup> )	green (Cr <sup>'''</sup> )
Cr <sub>2</sub> (SO <sub>4</sub> ) <sub>3</sub>	green	no change	no change	no change
Ni(NO <sub>2</sub> ) <sub>2</sub> ·6H <sub>2</sub> O	green	no change	no change	no change
NiCl <sub>2</sub> ·xH <sub>2</sub> O	green	no change	no change	no change
NiSO <sub>4</sub> ·7H <sub>2</sub> O	green	no change	no change	no change
Cu(NO <sub>2</sub> ) <sub>2</sub> ·6H <sub>2</sub> O	ylsh. green	no change	no change	no change
CuCl <sub>2</sub> ·2H <sub>2</sub> O	ylsh. green	no change	no change	no change
CuSO <sub>4</sub> ·5H <sub>2</sub> O	ylsh. green	no change	no change	no change
CuBr <sub>2</sub>	grnsh. yellow	no change	no change	no change
Co(NO <sub>2</sub> ) <sub>2</sub> ·6H <sub>2</sub> O	purple	no change	no change	no change
CoCl <sub>2</sub> ·6H <sub>2</sub> O	purple	no change	no change	no change
FeCl <sub>3</sub>	yellow	no change	no change	no change
KI (conc. aqueous solution) as Solvent				
I <sub>2</sub>	amber	no change	no change	no change

*Stability of Solutions.* As already indicated, one of the four sets of tubes was kept in the dark except during the time of making comparisons with other tubes. There was no check on the permanency of the color of this set except the authors' recollection of the original color. Occasionally there was an undoubted change, as in the reduction of hexavalent chromium to the trivalent state in certain solutions. To determine whether exposure to ultraviolet radiation, laboratory light, or sunlight had produced any effect, each tube so exposed was compared with the check kept in the dark. The observations thus made are summarized below.

All observations recorded relating to the stability of the solutions are those made one year from the date of starting the exposure. During the period of this exposure average conditions of weather (as regards the temperature and amount of sunlight) may be said to have prevailed.

In some cases exposure of two hours to the ultraviolet radiation produced marked changes, some solutions being colorless in an hour's time. Occasionally one thus decolorized seemed to regain its color, at least approximately, after being transferred to the glass tube and sealed up. One of the interesting effects was the deposition from certain of the solutions containing cupric salts of what was taken to be copper. The hue of the deposit resembled that of metallic copper, and in one case a residue was dissolved in nitric acid

and a test for copper obtained.<sup>7</sup> Another more or less frequent effect was the production of a strong, offensive odor, especially with solutions of the nitrates. No tests were made to identify the products; but, on opening the silica vessels to transfer the solution, the odor encountered resembled chlorine, oxides of nitrogen, or a mixture of the two.

TABLE II  
Stability of Various Solvents

Solvent	Effect of exposure		
	Laboratory light	Ultraviolet radn.	Sun light
CH <sub>3</sub> OH	no change	no change	no change
C <sub>2</sub> H <sub>5</sub> OH	no change	no change	no change
n-C <sub>3</sub> H <sub>7</sub> OH	no change	no change	no change
n-C <sub>4</sub> H <sub>9</sub> OH	no change	no change	no change
C <sub>2</sub> H <sub>4</sub> (OH) <sub>2</sub>	no change	no change	no change
C <sub>3</sub> H <sub>5</sub> (OH) <sub>3</sub>	no change	no change	no change
CH <sub>3</sub> .CO.OCC <sub>2</sub> H <sub>5</sub>	no change	no change	no change
CH <sub>3</sub> .CO.OCC <sub>4</sub> H <sub>9</sub>	no change	no change	no change
CHCl <sub>3</sub>	no change	yellowish	some dark res.
CCl <sub>4</sub>	no change	no change	no change
C <sub>2</sub> H <sub>5</sub> Br	amber	darker	nearly cls. + res.
C <sub>2</sub> H <sub>4</sub> Cl <sub>2</sub>	no change	no change	no change
C <sub>4</sub> H <sub>9</sub> Br	yellowish	amber	yellowish + res.
CS <sub>2</sub>	yellowish	yellowish + res.	amber + dark res.
C <sub>5</sub> H <sub>5</sub> N	yellowish	yellowish	amber + dark res.
CH <sub>3</sub> .CO.CH <sub>3</sub>	no change	no change	no change
CH <sub>3</sub> .COOH	no change	no change	no change

### Conclusions

One may consult the foregoing data with a view of learning what information is included for some given combination of solute and solvent, or of discovering any general relationships involved. In the former case the facts are at once available; but in the latter case conclusions equally definite are not easily formulated, having in mind particularly their bearing on the possible colorimetric use of the solutions studied. In considering the various systems their hue and stability may be discussed separately.

In connection with the hues there are none particularly striking to one hunting "something different". Although no effort was made to note fine distinctions in indicating the hues mentioned in Table I, it should be kept in mind that there were some interesting examples, such as the purple of the solutions of cobalt salts in constant boiling-point hydrochloric acid, and that all solutions designated as being green, for example, were not the same kind

<sup>7</sup> Vaidya [Nature, 123, 414 (1929)] in studying the action between cupric salts and glycerol obtained vigorous reaction on heating to 150°-200°C. with a reduction to metallic copper, except with cupric chloride.

of green. Anything further seemed of doubtful value until the solutions are prepared on a quantitative basis, which involves a quantitative determination both of their concentration and of their colorimetric characteristics. Such a study may well indicate that the colorimetric properties of some of these solutions are of special interest.

In connection with the stability of the different combinations the following statements are suggested as a summary of the observations made:

1. Some solutions, such as cupric chloride in methyl alcohol, react differently under the conditions of exposure used, and some, such as potassium chromate in acetic acid, do not. In general, where changes were noted, laboratory light produced the least effect, as indicated by change of hue or deposition of a residue, and sun light the most.

2. Different solutions react differently under the same conditions of exposure. This includes both those in which a given solute is dissolved in different solvents and those in which different solutes are dissolved in the same solvent. Solutions easily decolorized are undoubtedly out of the question for use as colorimetric standards; but it seems reasonable to believe that those which are apparently unchanged after exposure to laboratory light for one year deserve consideration as possible standards, as far as stability is concerned.

3. Some solvents are themselves more stable photochemically than others. On account of this, in certain cases where changes were observed, there may be some question as to the part played by the solute and the solvent in contributing to the changes.



THE NATURE OF ISOELECTRIC GELATIN IN SOLUTION. EVIDENCE FOR THE EXISTENCE OF THE AMPHOLYTE ION.  
I. IONIC DISPLACEMENT REACTIONS\*

BY ALLEN E. STEARN\*\*

Introduction

The elementary classical theory of ampholytes regards them as capable of combining with anions on the acid side of their isoelectric points and with cations on the alkaline side. In the isoelectric condition there are, of course, slight residual concentrations of both types of ampholyte ions, and thus a slight "overlapping" may be expected near the isoelectric pH. At the isoelectric point the neutral condition would be more or less chemically inert. The more recent theory, proposed by Bjerrum<sup>1</sup> and developed in simple form by Michaelis and Mizutani<sup>2</sup> suggests that the isoelectric condition is one of ampholyte ion which might be by no means chemically inert. It is difficult to determine experimentally the isoelectric state of an ampholyte from a study of its reactions with ordinary acids and bases where the anion of the former and the cation of the latter form compounds with the ampholyte in which the bonds are ionic. Modern and Pauli<sup>3</sup> state that blood albumin and egg albumin, when treated with small amounts of HCl near their isoelectric points combine with part of it giving: a. protein chloride; and b. positive and negative protein ions resulting from a combination of HCl with amphoteric ions. This is a type of combination hitherto unknown; but ideas as to isoelectric states seem to have come mostly from considerations of the apparent acidic and basic strengths of the ampholytes.<sup>4</sup>

If anions and cations could be found which tend to form co-valent linkages with the corresponding oppositely charged ampholyte ions it might be easier to follow their reactions through the isoelectric point. It would be advantageous, also, to be able to add these ions in some form other than free acid or base so that pH could be controlled independently of the quantities of reactants present.

It has been found that certain dyes seem to fulfill these requirements in their reaction with gelatin.

In the present paper data are presented indicating a replacement reaction between dyes and some part of the gelatin molecule or some ion of gelatin. It will be seen that the reacting tendency is sufficiently strong with basic dyes to displace H-ion and with acid dyes to replace OH-ion. In the second paper results of conductivity measurements will be presented.

\* From the Department of Chemistry, Stanford University.

\*\* Visiting Professor by courtesy of the Department of Chemistry of Stanford University.

When a gelatin solution, adjusted to a certain pH, is mixed with one, for example, of basic dye at the same pH there is a very significant decrease in pH. The opposite effect is noted with acid dyes. There are two apparent mechanisms.

a. The chemical mechanism:



or better



Where  $\text{D}^+$  stands for dye cation and Ge for the gelatinate radicle; or b. an adsorption mechanism depending on the equilibrium



If the gelatin adsorbs the free dye base, the increase in HCl concentration and consequent lowering of pH is obtained. Many considerations point to the former as the effective mechanism. These will be pointed out later.

*Experimental.* The gelatin used was the Eastman ash-free product. It contained, on ignition, 0.08% of residue. The dyes used were Grüber products except the crystal violet, which was from The National Aniline Company. A sample of yeast nucleic acid from Eastman was also used. This was found to be free from all but faint traces of chlorides and sulphates. The pH values were measured by potentiometer using a quinhydrone electrode against a saturated calomel electrode. The gelatin solutions were 1% and the dye solutions contained 3 grams per liter except the crystal violet which contained 1.5 grams per liter.

In the experiments whose results are presented in Tables I and II the mixture represents equal volumes of dye and gelatin solutions. The change in pH is calculated from the pH of the mixture and that of the original gelatin solution since the dye is not buffered. In practically all cases this gives the lower limiting effect.

TABLE I  
Change of pH when basic dye and gelatin solutions are mixed

	Crystal Violet			Malachite Green		
	pH	$-\Delta\text{pH}$	$\Delta(\text{H}^+)$	pH	$-\Delta\text{pH}$	$\Delta(\text{H}^+)$
1 dye	3.92			3.02		
2 gelatin	3.91			3.00		
3 mixture	3.83	.08	$2.5 \times 10^{-5}$	3.00	—	—
1 dye	4.64			3.95		
2 gelatin	4.64			3.98		
3 mixture	4.29	.35	$2.8 \times 10^{-5}$	3.90	.08	$2. \times 10^{-5}$
1 dye	5.64			4.61		
2 gelatin	5.64			4.62		
3 mixture	5.32	.32	$2.5 \times 10^{-6}$	4.46	.16	$1.1 \times 10^{-6}$
1 dye	6.27			5.60		
2 gelatin	6.46			5.60		
3 mixture	5.94	.52	$8. \times 10^{-7}$	5.25	.35	$3.2 \times 10^{-6}$

TABLE II  
Change in pH when acid dye and gelatin solutions are mixed

	Acid Fuchsin			Eosin		
	pH	$\Delta\text{pH}$	$-\Delta(\text{H}^+)$	pH	$\Delta\text{pH}$	$-\Delta(\text{H}^+)$
1 dye	3.13					
2 gelatin	3.13			eosin is not soluble at these lower pH values		
3 mixture	3.32	.19	$2.6 \times 10^{-4}$			
1 dye	3.75					
2 gelatin	3.75					
3 mixture	4.10	.35	$1. \times 10^{-4}$			
1 dye	4.60			4.58		
2 gelatin	4.62			4.62		
3 mixture	4.73	.11	$5. \times 10^{-6}$	4.70	.08	$4. \times 10^{-6}$
1 dye	5.64			5.61		
2 gelatin	5.62			5.61		
3 mixture	6.05	.43	$1.5 \times 10^{-6}$	5.68	.07	$3.5 \times 10^{-7}$

While the change in H-ion concentration is obviously not a direct measure of the amount of reaction taking place, certain indications are apparent. At low pH the effect of acid dye seems qualitatively greater than that of basic dye, while at higher pH the opposite is true. The significant fact brought out here, however, is that there is apparently no discontinuity at the isoelectric point. This indicates to the author either that the isoelectric condition is one of reactive ampholyte ion of such a nature that localized portions can act as electron donors or acceptors with the proper reagent, or else that the stability constants of the dye proteinates are enormously small.

Table III gives a more detailed study of the system crystal violet-gelatin.

TABLE III

To 25 cc. dye soln. pH 3.91 were added increments of gelatin soln. pH 3.91				To 25 cc. dye soln. pH 5.64 were added increments of gelatin soln. pH 5.64			
cc. gel. added	pH mixture	$-\Delta\text{pH}$	$-\Delta(\text{H}^+) \times 10^6$	cc. gel. added	pH mixture	$-\Delta\text{pH}$	$\Delta(\text{H}^+) \times 10^6$
0	3.91	—	—	0	5.64	—	—
5	3.81	.10	3.2	5	5.29	.35	2.8
10	3.82	.09	2.8	10	5.31	.33	2.6
15	3.83	.08	2.5	15	5.33	.31	2.4
20	3.84	.07	2.2	20	5.35	.29	2.2
25	3.85	.06	1.8	25	5.38	.26	1.9
31.5	3.86	.05	1.5	31.5	5.42	.22	1.5
41.5	3.87	.04	1.2	41.5	5.49	.15	.95
62.5	3.88	.03	.9	62.5	5.54	.10	.6
125.	3.90	.01	.3	125.	5.59	.05	.3

TABLE III (Continued)

To 25 cc. dye soln. pH 4.66 were added increments of gelatin soln. pH 4.66				To 25 cc. dye soln. pH 6.36 were added increments of gelatin soln. pH 6.36			
0	4.66	—	—	0	6.36	—	—
5	4.25	.41	3.4	5	5.90	.46	.82
10	4.27	.39	3.2	10	5.93	.43	.74
15	4.29	.37	2.94	15	5.97	.39	.64
20	4.30	.36	2.8	20	5.98	.38	.61
25	4.32	.34	2.6	25	5.99	.37	.58
31.5	4.35	.31	2.3	31.5	6.05	.31	.46
41.5	4.39	.27	1.9	41.5	6.10	.26	.36
62.5	4.43	.23	1.5	62.5	6.15	.21	.27
125.	4.53	.13	.76	125.	6.27	.09	.10

These figures seem to show a tendency toward a maximum change in H-ion concentration near the isoelectric pH. Tables IV and V give results down to lower limiting pH values.

Table IV  
Crystal Violet

To 25 cc. dye soln. pH 3.02 were added increments of gel soln. pH 3.02			To 25 cc. dye soln. pH 2.44 were added increments of gel. soln. pH 2.44		
cc. gel. added	pH Mixture	$\Delta$ pH	cc. gel. added	pH mixture	$\Delta$ pH
0	3.02	—	0	2.44	—
5	3.02	—	5	2.44	—
10	3.02	—	10	2.44	—
15	3.02	—	15	2.44	—

TABLE V  
Acid Fuchsin

To 25 cc. dye soln. pH 3.02 were added increments of gel. soln. pH 3.02				To 25 cc. dye soln. pH 2.36 were added increments of gel. soln. pH 2.36			
cc. gel. added	pH mixture	$\Delta$ pH	$-\Delta(\text{H}^+) \times 10^4$	cc. gel. added	pH mixture	$\Delta$ pH	$-\Delta(\text{H}^+) \times 10^4$
0	3.02	—	—	0	2.36	—	—
5	3.13	.11	2.1 (ppt.)	5	2.37	?	less (ppt.)
10	3.21	.19	3.4 "	10	2.37	?	than "
15	3.22	.20	3.5 "	15	2.37	?	$10^{-4}$ "
25	3.19	.17	3.1 "				
41.5	3.17	.15	2.8 "				
60	3.13	.11	2.1 (redissolved)				
100	3.09	.07	1.4 "				

TABLE V (Continued)

To 25 cc. dye soln. pH 1.93 were added increments of gel. soln.				To 25 cc. gel. soln. pH 1.88 were added increments of dye soln.			
pH 1.93				pH 1.88			
cc. gel. added	pH mixture	$\Delta$ pH		cc. dye added	pH mixture	$\Delta$ pH	
0	1.93	—		0	1.88	—	
5	1.93	— (ppt.)		5	1.88	—	(no ppt.)
10	1.93	—	"	10	1.88	—	" "
15	1.93	—	"	15	1.88	—	" "

The tables bring out clearly the fact that at lower pH values it is the acid dye which is the more effective of the two in combining, but that in any case a lower pH limit is reached where the pH change is lost.

These results are predictable on, and indicative of, a chemical mechanism for the reaction between protein, at least gelatin, and dyes of these types. Thus, whether we picture the nature of the protein as represented by the equilibrium



or, after Michaelis, by the equilibria of a dibasic acid

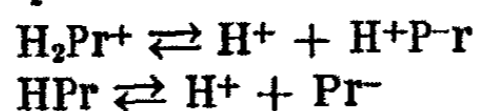

a qualitative prediction of the above behavior is obtained. The basic dye ions, by uniting with protein anion, shift the equilibrium toward the liberation of H-ion.  $D^+ + Pr^- \rightarrow DPr$ . Acid dyes would cause an opposite shift. Regardless of whether the isoelectric protein is or is not reactive to the dye, a pH will be reached where, with basic dye, the concentration of  $Pr^-$  or of both  $Pr^-$  and  $H^+Pr^-$  will be less than that required by the stability constant value for the reaction:



or the equilibrium constant for the reaction

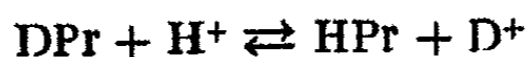

and no further reaction will take place. With acid dyes reaction will still take place, but as soon as all of the protein has been transformed into the cationic condition there can be no further change in pH by liberation of OH-ion (or using up of H-ion).

On the alkaline side of the isoelectric point an analogous situation may be expected. Experiments were not carried to this point with gelatin due to the fact of dye precipitation long before it is reached. But a somewhat similar case can be shown with nucleic acid. Work with this substance brings out another point also. Nucleic acid is distinctly acidic at any ordinary pH and we should not expect any effect with acidic dyes. Some results are given in Table VI. A .5% solution of the acid which can be obtained thru the pH range studied, even though the free acid is not so soluble, was used. The method was similar to that used with gelatin.

TABLE VI  
Change in pH when dye and nucleic acid solutions are mixed.

	Acid Dyes				Basic Dyes			
	Acid Fuchsin		Eosin		Crystal Violet		Malachite Green	
	pH	$\Delta$ pH	pH	$\Delta$ pH	pH	$-\Delta$ pH	pH	$-\Delta$ pH
dye	3.94		3.97		3.90		3.10	
acid	3.96		3.97		3.84		3.10	
mixture	3.95	—	3.96	—	3.42	.42	3.02	.08
dye	4.65		4.65		4.73		4.03	
acid	4.65		4.66		4.60		4.03	
mixture	4.65	—	4.66	—	4.24	.36	3.84	.19
dye	5.58		5.54		5.66		4.66	
acid	5.57		5.56		5.62		4.65	
mixture	5.57	—	5.56	—	5.25	.37	4.40	.25
dye					7.12		5.65	
acid					7.13		5.56	
mixture					7.04	.09	5.36	.20

Here it is to be noted that pH 7 the change in H-ion concentration is only of the order of  $10^{-8}$ . I.e. there is no un-ionized nucleic acid to furnish H-ion by replacement with the dye ion.

It may be instructive to show this same type of effect in the reaction between lead ion and acetic acid, where the mechanism is known to be the same as the chemical one postulated above, i.e.:

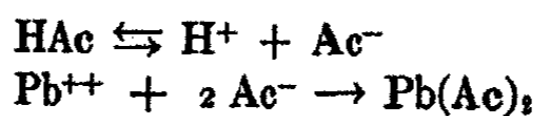

Table VII gives some such data. Acetate-acetic acid mixtures of known pH were made 0.07 molal in  $\text{PbCl}_2$  by addition of a weighed quantity of the salt and the pH change determined. For comparison in order of magnitude with the well known "salt effect" the same measurements were made on these buffers which had been made .33 molal in KCl.

TABLE VII

pH orig. buffer	KCl — — 0.33 molal			PbCl <sub>2</sub> — — 0.07 molal			$\Delta(\text{H})_{\text{Pb}}/\Delta(\text{H})_{\text{K}}$
	pH	$-\Delta$ pH	$\Delta(\text{H}^+)$	pH	$-\Delta$ pH	$\Delta(\text{H}^+)$	
2.18	2.18	—	—	1.99	.19	$3.6 \times 10^{-3}$	very large
3.26	3.23	.03	$4 \times 10^{-6}$	2.95	.31	$5.7 \times 10^{-4}$	14.
4.28	4.25	.03	$4 \times 10^{-6}$	4.09	.19	$3. \times 10^{-5}$	7.5
5.25	5.20	.05	$.7 \times 10^{-7}$	5.12	.13	$1.9 \times 10^{-6}$	2.7

As the acetic acid is more and more nearly ionized both  $\Delta(\text{H}^+)$  and the ratio of the  $\Delta(\text{H}^+)$  values for lead and for potassium salts become smaller.

DISCUSSION. Qualitatively several observations militate against the adsorption mechanism suggested above. In the first place the effect does not depend on precipitation of dye proteinate. In the second place it is larger, in many cases, in pH regions where hydrolysis of dye salt would be completely repressed, than where this hydrolysis might be expected to take place. Finally, if unionized dye base is removed and dye salt replaced by inorganic acid, or dye ion by H-ion, the conductivity of the solution might be expected to increase. The next paper will present data showing that actually the conductivity decreases.

None of these observations run contrary to the chemical mechanism postulated, however. This type of chemical mechanism seems also to fit the observations of Northrop and Kunitz<sup>6</sup> who found that some metals, notably copper, formed covalent linkages with gelatin involving, apparently, a stoichiometrical type of equilibrium such as:

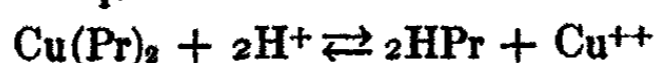

The maximum total positive ion in combination being in all cases about .9 millimols per gram gelatin. Probably the most significant point brought out by the data here presented is the fact that combination with both the acidic and basic dye groups takes place seemingly continuously through a pH range which extends right thru the isoelectric point. If the assumption of a chemical reaction is the true one, and it is in agreement with the conclusions both of Chapman, Greenberg, and Schmidt<sup>6</sup> and of Rakusin<sup>7</sup> on the reaction between dyes and proteins, then it can be easily shown that the classical theory of amphoteric mechanism does not hold here. What mechanism does hold is not so easy to state and a critical discussion of the complete titration curve of gelatin is reserved for a later paper.

Thus if the isoelectric condition is one of inertness we can get approximate apparent values for the stability constants of the dye-protein compounds from concentrations of dye cation concentrations and protein anion concentrations. In the pH range studied the equivalent weight of gelatin to the basic ion is 3300 (3290 according to Atkin and Douglas<sup>8</sup> and its value of  $K_a = 2 \times 10^{-6}$ . ( $K_b$  being  $5 \times 10^{-11}$ ). A 1% solution, then, would represent a total concentration of 0.003 N. (For the argument the precision of the numerical values is not material.) The dye concentration of a solution of 1.5 grams per liter would be about .00375, or about .0034 equivalents of dye ion per liter. From these values the ratios

$$\frac{\text{protein anion}}{\text{unionized protein}} \quad \text{and} \quad \frac{\text{protein cation}}{\text{unionized protein}}$$

can be determined for any pH, and if we know the total protein concentration we can get the equilibrium concentration of protein anion. The total protein concentration will be the sum of the concentrations of cation, anion, and unionized, or will in general be .003, minus the change in H-ion concentration which is small, and corrected for the dilution effect of the dye solution added. The equilibrium dye ion concentration will be about .0034 minus change in H-ion concentration (again small), and corrected for dilution due to gelatin solution.

Table VIII gives values for the ion product at various pH values. The data is taken from Table III and the dilutions are 25 volumes of dye to 5 of gelatin for the left half and a 1:1 mixture for the other half.

TABLE VIII

pH	Ion Concentrations		Ion Product, K	pH	Ion Concentrations		Ion Product, K.
	dye $\times 10^3$	proteinate			dye $\times 10^3$	proteinate	
3.81	2.8	$7.4 \times 10^{-7}$	$2. \times 10^{-9}$	3.85	1.7	$2.6 \times 10^{-6}$	$4.5 \times 10^{-9}$
4.25	2.8	$1.3 \times 10^{-6}$	$3.6 \times 10^{-8}$	4.32	1.7	$4.3 \times 10^{-6}$	$7.3 \times 10^{-8}$
5.29	2.8	$1.4 \times 10^{-4}$	$4. \times 10^{-7}$	5.38	1.7	$4.8 \times 10^{-4}$	$8.2 \times 10^{-7}$
5.90	2.8	$3.1 \times 10^{-4}$	$8.7 \times 10^{-7}$	5.99	1.7	$1. \times 10^{-3}$	$1.7 \times 10^{-6}$

The variation of the ion product, changing through a ratio of over  $10^3$  through a pH range of only a little more than 2 units clearly indicates that the dye must react, if it reacts chemically at all, not only with protein anion but also with some other molecular or ionic species as well. At first sight these figures might indicate only an insignificant amount of reaction taking place. That this is not the case is clearly shown, however, in the data presented in the following paper, and there the actual mechanism is discussed somewhat more fully.

#### Summary

Gelatin is shown to undergo a replacement reaction with acid dyes and basic dyes; the former liberating OH-ion or using up H-ion and the latter liberating H-ion.

This reaction proceeds continuously thru a pH range extending to both sides of the isoelectric point.

While the mechanism simulates an ionic displacement reaction, the data indicate that the dyes react not only with free protein ions but with some other form of protein.

This is thought to be an ampholyte ion, the form in which isoelectric protein may largely exist.

#### References

- <sup>1</sup> N. Bjerrum: *Z. physik. Chem.*, 104, 147 (1923).
  - <sup>2</sup> L. Michaelis and M. Mizutani: *Z. physik. Chem.*, 116, 152 (1925).
  - <sup>3</sup> F. Modern and W. Pauli: *Anales soc. quim. Argentina*, 23, 93 (1925); (from *Chem. Abs.*, 19, 3500 (1925)).
  - <sup>4</sup> L. Michaelis: "Hydrogen Ion Concentration," pp. 67 et. seq. (1926).
  - <sup>5</sup> J. H. Northrop and M. Kunitz: *J. Gen. Physiol.*, 11, 481 (1928).
  - <sup>6</sup> L. M. Chapman, D. M. Greenberg and C. L. A. Schmidt: *J. Biol. Chem.*, 72, 707 (1927).
  - <sup>7</sup> M. A. Rakusin: *Biochem. Z.*, 192, 167 (1928).
  - <sup>8</sup> W. R. Atkin and G. W. Douglas: *J. Am. Leather Chemists Assn.*, 19, 528 (1924).
- Columbia, Missouri.*



THE NATURE OF ISOELECTRIC GELATIN IN SOLUTION.  
II. CONDUCTIVITY TITRATIONS OF GELATIN  
WITH CRYSTAL VIOLET\*

BY ALLEN E. STEARN

Introduction

In the preceding paper it was shown that acid dyes reacted with gelatin with increase in OH-ion concentration and basic dyes with increase in H-ion concentration. This was viewed in the light of a replacement reaction. In the present paper the effect of the presence of one of the dyes there used, crystal violet, on the conductivity of gelatin solutions is studied. From these data the extent to which the reaction proceeds can be semiquantitatively inferred.

The conductivities were measured by means of a Wheatstone bridge set up using a dipping cell whose constant, measured in 0.01 normal KCl solution, was 0.7610. The sample of gelatin used contained 0.08% ash and the crystal violet 0.26% ash. The stock solutions employed contained, respectively, 1.5 grams per liter of the dye and 10 grams per liter of the gelatin. The latter was always prepared fresh the day it was used. The water used had a conductivity, measured with the above cell, of 2 to 3  $\times 10^{-6}$  reciprocal ohms. The measurements were carried out at four initial pH values, though, as seen in the preceding paper there is a pH change during the titrations. The initial values were 3.9, 4.7, 5.5 and 7. For the latter two values unadjusted water was used as solvent, though for the experiments at pH's 4.7 and 3.9 the water itself was brought to these values in the respective cases by addition of HCl. Thus the conductivity of the water itself had to be corrected for, and it was thought unnecessary to prepare water better than that above mentioned.

The usual procedure was as follows. 500 cc. of water at the proper temperature and pH was "titrated" with 1% gelatin solution at the same pH. That is, increments of the gelatin solution were added and the conductivity of the resulting solution determined after the addition of each increment. When this blank titration had been completed 500 cc. of a solution containing dye at the same pH as the original water and gelatin was substituted for the original water and the titration repeated with the gelatin solution. The change in conductivity due to the change in H-ion concentration at pH 7 was not such as to affect the values obtained, but this was not the case for the titrations at pH 3.9 or 4.7, and there was an appreciable effect from this cause at pH 5.5. For this reason electrometric titrations were made at these pH's under the same conditions as those under which the conductivity titrations had been made so that correction for the change in conductivity

\* From the Chemical Laboratories of Stanford University and of the University of Missouri.

due to change in H-ion concentration could be made. The method of making these last mentioned titrations was that described in the preceding paper.

From the data obtained as above described the conductivity due to a certain quantity of gelatin in water and that in dye solution could be compared.

Preliminary experiments showed that the conductivity of solutions of such a salt as KCl is not affected by the presence of dye or gelatin to an extent greater than about 1%. For example at 25°C.:

10 cc. KCl solution increased the conductivity of 350 cc. water by 139.5 units.

10 cc. of the same KCl solution increased the conductivity of 250 cc. water and 100 cc. 1% isoelectric gelatin by 140 units. (Difference 0.4%)

10 cc. of the same KCl solution increased the conductivity of 250 cc. water and 100 cc. 1% gelatin solution pH 7 by 138 units. (Difference -1.08%)

10 cc. of the same KCl solution increased the conductivity of 300 cc. water and 50 cc. stock dye solution by 138.5 units. (Difference -0.73%)

(The unit of conductivity used here, as throughout, is  $10^{-6}$  reciprocal ohm.)

### Results

Tables I to IV give the conductivity data at the four pH's studied, while Tables IA to IIIA give the electrometric data from which the correction,  $\Delta k_H$ , for the effect on the conductivity of the change in H-ion concentration is obtained. The conductivities in the various columns labeled k are expressed in units of  $10^{-6}$  reciprocal ohm, and have been corrected for the conductivity of the water blank and for the volume change resulting from the addition of titrating solution. I.e. that of a solution such that 20 cc. of a titrating solution had been added to an original volume of 500 cc. was multiplied by 520/500. This procedure might involve a questionable assumption for any single value, but since the results are differential, any effect of such assumptions will cancel out. The temperature was in all cases 28.5°C.  $\pm$  0.03°.

TABLE I  
Dye-Gelatin pH 3.9

cc. gelatin soln. added	cond. of 500 cc. HOH plus gel. $k_1$	cond. of 300 cc. HOH and 200 cc. dye soln. plus gel. $k_2$	apparent cond. decrease. $k_1 - (k_2 \cdot \frac{500}{270})$	cond. increase from $\Delta(H^+)$ . $\Delta k_H$	corrected cond. decrease $\Delta k$	cond. of dye and gel. ions before mixing	% cond. decrease
0	—	217.5	—	—	—	—	—
20	34.2	245.0	6.7	12.64	19.34	65.1	29.7
40	62.0	169.0	10.5	19.45	29.95	72.8	41.4
60	83.6	288.2	12.9	21.4	34.3	79.3	43.2
80	104.0	306.9	14.6	23.3	37.9	85.4	44.4
100	122.5	325.3	14.7	25.3	40.0	91.0	44.0

TABLE IA  
300 cc. water plus 200 cc. stock dye solution, pH 3.92 titrated with 1% gelatin solution, pH 3.92

cc. gel. soln. added	pH	(H <sup>+</sup> ) × 10 <sup>4</sup>	Δ(H <sup>+</sup> ) × 10 <sup>4</sup>	Δk <sub>n</sub> <sup>1</sup>
0	3.92	1.22	—	—
20	3.83	1.48	2.6	12.64
40	3.79	1.62	4.0	19.45
60	3.78	1.66	4.4	21.4
80	3.77	1.70	4.8	23.3
100	3.76	1.74	5.2	25.3

<sup>1</sup> The equivalent conductivity of the H-ion at 28.5° C. was taken as 370, and this with cell constant of 0.761 gives, for Δk<sub>n</sub>, 0.486 Δ(H<sup>+</sup>) in units of 10<sup>-4</sup> reciprocal ohm. †

A word about the last two columns in Table I is necessary. The final column gives an approximate value for the per cent decrease in conductivity based on the total conductivity of the ions involved in the postulated reactions. Thus, for a reaction of the type

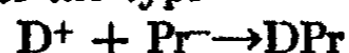

where D<sup>+</sup> represents the dye cation and Pr<sup>-</sup> the protein anion, the limit in conductivity decrease is reached when one or the other of these ion species is completely used up. For this reason 100% of the conductivity due to these ion species will give the maximum possible conductivity decrease. Therefore column 7 of the table gives approximate values for the sum of the conductivities which these two ion species would contribute to the total conductivity if no reaction took place between them. These values could be obtained either by subtracting the conductivity of the Cl-ion in the dye sample from the total conductivity of the dye solution, and that of the Na-ion or Cl-ion (due to acid or base used in pH adjustment) from the total conductivity of the gelatin solution, or, more easily and probably as precisely, from the transference numbers of the dye ion in the chloride and of the gelatin ion in its salts. Calculations made from data on gelatin solutions with known amounts of NaOH gave a value of 0.3 for the transference number of the gelatinate ion at a pH of 7, a value in accord with the general findings of Pauli<sup>1</sup> on the mobility of protein ions. This value was used throughout, though in the one case of pH 3.9 it is probably a bit high. From a study of a large number of related compounds<sup>2</sup> the mobility of the crystal violet ion was taken as about 24 to 25 at 25°C. giving it a transference number in the chloride of about 0.25. The lack of precision in these values is recognized, but they are thought to be sufficiently close to be indicative and no precise quantitative deductions from them are attempted.

Thus the values in column 7 of Table I are obtained by adding 0.3 k<sub>1</sub> and 0.25 × 217.5. For Table II, giving data at the isoelectric pH of gelatin, the entire gelatin conductivity is used, while the corresponding values in Tables III and IV are obtained in a manner similar to that employed in Table I.

TABLE II  
Dye-Gelatin pH 4.7

cc. gelatin soln. added	cond. of 500 cc. HOH plus gel. $k_1$	cond. of 300 cc. HOH and 200 cc. dye soln. plus gel. $k_2$	apparent cond. decrease $k_1 - (k_2 - 206.8)$	cond. increase from $\Delta(H^+)$ . $\Delta k_H$	corrected cond. decrease $\Delta k$	cond. of dye and gel. ions before mixing	% cond. decrease
0	—	206.8	—	—	—	—	—
20	1.8	208.7	-0.1	8.94	8.84	53.5	16.5
40	3.4	208.2	2.0	11.81	13.81	55.1	25.1
60	4.9	208.0	3.7	12.34	16.04	56.6	28.3
80	6.3	208.1	5.0	12.34	17.34	58.0	29.9
100	7.82	208.1	6.52	11.81	18.33	59.52	30.8

TABLE IIA

300 cc. water plus 200 cc. stock dye solution, pH 4.67 titrated with 1% gelatin solution, pH 4.68

cc. gel. solution added	pH	$(H^+) \times 10^6$	$\Delta(H^+) \times 10^6$	$\Delta k_H$
0	4.67	2.14	—	—
20	4.40	3.98	1.84	8.94
40	4.34	4.57	2.43	11.81
60	4.33	4.68	2.54	12.34
80	4.33	4.68	2.54	12.34
100	4.34	4.57	2.43	11.81

TABLE III

Dye-Gelatin pH 5.5

cc. gelatin soln. added	cond. of 500 cc. HOH plus gel. $k_1$	cond. of 300 cc. HOH and 200 cc. dye soln. plus gel. $k_2$	apparent cond. decrease $k_1 - (k_2 - 212.5)$	cond. increase from $\Delta(H^+)$ . $\Delta k_H$	corrected cond. decrease $\Delta k$	cond. of dye and gel. ions before mixing	% cond. decrease
0	—	212.5	—	—	—	—	—
20	7.04	214.6	4.94	0.8	5.74	54.9	10.4
40	13.4	216.2	9.7	1.3	11.0	57.1	19.3
60	20.56	219.1	14.0	1.6	15.6	59.27	26.3
80	27.7	222.2	18.0	1.8	19.8	61.4	32.2
100	34.8	226.1	21.2	1.86	23.06	63.54	36.3

TABLE IIIA

300 cc. water plus 300 cc. stock dye solution, pH 5.58 titrated with 1% gelatin solution, pH 5.59

cc. gel. solution added	pH	(H <sup>+</sup> ) × 10 <sup>9</sup>	Δ(H <sup>+</sup> ) × 10 <sup>9</sup>	Δk <sub>H</sub>
0	5.58	2.63	—	—
20	5.37	4.27	1.64	0.8
40	5.27	5.37	2.74	1.3
60	5.23	5.89	3.26	1.6
80	5.20	6.31	3.67	1.8
100	5.19	6.46	3.83	1.86

TABLE IV

Dye-Gelatin pH 7

cc. gelatin soln. added	cond. of 500 cc. HOH plus gel. k <sub>1</sub>	cond. of 300 cc. HOH and 200 cc. dye soln. plus gel. k <sub>1</sub>	apparent cond. decrease k <sub>1</sub> -(k <sub>2</sub> -211.)	cond. of dye and gel. ions before mixing	% cond. decrease
0	—	211.0	—	—	—
20	11.85	215.2	7.65	56.3	13.6
40	23.7	220.2	14.5	59.86	24.2
60	35.0	225.0	21.0	63.25	33.2
80	46.8	231.0	26.8	66.8	40.1
100	58.25	236.9	32.35	70.2	46.1

In the above form the data indicate qualitatively that there is a large conductivity decrease in all cases. This is of the same order of magnitude through the pH range extending through the isoelectric point of the gelatin to a considerable distance on either side. Although in all the experiments reported there was never an appreciable excess of gelatin present, nevertheless in a few less carefully controlled experiments in which the titrations were carried out until there was a distinct excess of the titrating reagent, typical conductivimetric titration curves were obtained in which the per cent decrease in conductivity passed through a definite maximum.

The above data can, however, be put into a somewhat more suggestive form from the point of view of the reactivity of the gelatin through the pH range 3.9 to 7. For this purpose it will be necessary to inquire a bit more definitely into the state of the gelatin through this range.

For this purpose the complete titration curve of gelatin with both acid and base published by Atkin and Douglas<sup>3</sup> and carefully repeated by the present author<sup>4</sup> serves. According to their interpretation of their curve, Atkin and Douglas give, for K<sub>a</sub>, 2 × 10<sup>-6</sup>, and for K<sub>b</sub>, 5 × 10<sup>-11</sup>. For the equivalent weights their curve shows about 1100 towards acids and, for a pH range not extending beyond 7, about 3300 toward bases. The difference in



gelatin solution of total gelatin concentration  $c$ , then, under the above conditions,

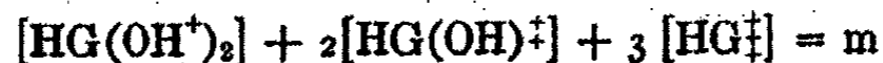

The concentrations of all these ion species can be expressed in terms of  $m$ ,  $[\text{H}^+]$ , and  $c$ , all of which are known, and of the three basic ionization constants. Three such equations can then be solved simultaneously for  $K_b$ ,  $K_b'$  and  $K_b''$ . In this treatment the value of  $c$  is no longer equivocal, and can be obtained using 3300 as the equivalent weight.

Following the above outlined procedure, the values obtained are as follows:

$$\begin{aligned} K_b &= 7.9 \times 10^{-11} \\ K_b' &= 3.4 \times 10^{-11} \\ K_b'' &= 7. \times 10^{-12} \end{aligned}$$

These values give a calculated isoelectric point at a pH of 4.77 using  $K_a = 2 \times 10^{-6}$ . Since the titration curve is not so easy to read between the pH limits 4.7 and 7.0 as it is on the acid side of 4.7, it was considered better to take the isoelectric point as at pH 4.7, which corresponds to a value of  $K_a$  of  $3.6 \times 10^{-6}$ . This latter value is used in calculating the magnitudes given in Table V, which represent the state of a 0.000115 molal gelatin solution at various pH values. This particular concentration of gelatin is that obtained when 20 cc. of a 1% solution is added to a volume of 500 cc. and thus represents the gelatin concentration used in the above experiments in the presence of the largest excess of dye employed.

TABLE V

1 pH	2 [H <sup>+</sup> ]	3 [G(OH <sup>-</sup> ) <sub>3</sub> ]	4 [HG(OH <sup>+</sup> ) <sub>2</sub> ]	5 [HG(OH) <sup>‡</sup> ]	6 [HG <sup>‡</sup> ]	7 [HG(OH) <sub>3</sub> ]
3.9	$1.26 \times 10^{-4}$	$6.2 \times 10^{-6}$	$4.59 \times 10^{-6}$	$1.95 \times 10^{-5}$	$1.7 \times 10^{-8}$	$4.17 \times 10^{-6}$
4.7	$2. \times 10^{-5}$	$1.54 \times 10^{-5}$	$1.33 \times 10^{-5}$	$8.4 \times 10^{-7}$	$1.4 \times 10^{-8}$	$8.63 \times 10^{-6}$
5.5	$3.16 \times 10^{-6}$	$6.03 \times 10^{-5}$	$1.02 \times 10^{-5}$	$3.0 \times 10^{-7}$	$7. \times 10^{-10}$	$5.35 \times 10^{-5}$
7.0	$1.0 \times 10^{-7}$	$1.119 \times 10^{-4}$	$\pm 10^{-8}$	—	—	$3.1 \times 10^{-6}$

From the quantities in this table it will be possible to inquire what change in conductivity would be expected if *all* the gelatin were combined with dye, regardless of its original state, to form an un-ionized dye gelatinate. For the systems with the largest excess of dye we have a gelatin concentration of 0.000115. Thus there will disappear from conducting form in solution a) 0.000115 equivalents of dye ion in all cases where the largest excess of dye is present, and b) the number of equivalents of gelatin anion given in column 3 of Table V, and finally c) a number of equivalents of gelatin cation equal

to the value of the monovalent ion concentration in column 4 plus twice the value of the divalent ion concentration in column 5 plus three times the value of the trivalent ion concentration in column 6.

The relative mobilities of the ion species are not known, but probably will not differ greatly. On the assumption that they are the same we have that the ratio of conductivity decrease to the total conductivity of the gelatin ions before the addition of dye should be given by the ratio of the total sum of equivalents of ion species disappearing, as given above, to the sum of equivalents of gelatin ion species disappearing. If all the gelatin combines, then, this ratio would be given by

$$\frac{[D^+] + [G(OH^-)_3] + [HG(OH^+)_2] + 2 [HG(OH)^\ddagger] + 3 [HG^\ddagger]}{[G(OH)_3^-] + [HG(OH)_2^+] + 2 [HG(OH)^\ddagger] + 3 [HG^\ddagger]}$$

The values of this ratio for  $[D^+] = 0.000115$ , i.e. for the condition of the largest excess of dye, are compared in Table VI with the ratio of the measured decrease in conductivity to the conductivity of the gelatin ion species for the various pH's. The experimental values for this latter ratio are also given for the condition of the smallest excess of dye used. In the table, the latter is given under B and the former under A. It should perhaps be pointed out that the symbol  $[D^+]$  above represents the equivalents of dye ion disappearing rather than the total dye ion concentration, in this case.

TABLE VI

pH		measured $\Delta k$	k gelatin ions	measured % decrease	theoretical maximum % decrease
3.9	A	19.3	10.26	190.*	230.
	B	40.0	36.75	109.	
4.7	A	8.84	1.8	490.	478.
	B	18.33	7.8	235.	
5.5	A	5.74	2.11	272.	285.
	B	23.06	10.44	220.	
7.0	A	7.65	3.56	215.	203.
	B	32.35	17.48	185.	

\* As pointed out above, the value of the gelatin cationic transference number in chloride is probably smaller than the value of the corresponding anionic number of the sodium salt. Thus the agreement between the measured and the calculated values in columns 4 and 5 for a pH of 3.9 is distinctly poorer than that at other pH values. If 0.25 be used in place of 0.3 for the cationic transference number in this particular case, then the measured % decrease becomes 226. in place of 190.

It is recognized that the apparent quantitative agreement shown in Table VI is fortuitous, though the results are considered qualitatively sound, and quite suggestive and significant. There are two compensating sources of error. a) One is the assumption that the divalent and trivalent gelatin



cations have, respectively, double and triple the mobility of the monovalent ions. This leads to a theoretical value in Table VI which is too low and becomes increasingly felt. b) The amount of H-ion liberated, as given in tables IA to IIIA, does not account for ALL the available H-ion if the reaction does go to completion in the presence of sufficient excess of dye. Ignoring this factor leads to theoretical values in Table VI which are too high, and are also increasingly so for lower pH's. For example at pH 4.7 the measured  $\Delta[H^+]$  when 20 cc. of gelatin solution is added to the dye solution is about  $2 \times 10^{-6}$ , whereas one would expect about  $10^{-4}$ . The author was puzzled for a time as to where this H-ion might have gone, assuming, as seems fairly definitely indicated, that complete reaction took place. The following preliminary experiment indicates that probably the dye itself "binds" it. 100 cc. of dilute KCl was titrated with N/10 HCl and then under the same conditions 100 cc. of an approximately 0.1% solution of gentian violet was titrated with the same HCl solution. (The sample of crystal violet having been exhausted.) Table VII gives the results.

TABLE VII

cc. N/10 HCl added	KCl Solution		Dye Solution	
	pH	H	pH	H
0.00	6.60	$2.5 \times 10^{-7}$	5.25	$5.6 \times 10^{-6}$
0.10	5.95	$1.1 \times 10^{-6}$	4.90	$1.26 \times 10^{-5}$
0.30	4.20	$6.3 \times 10^{-6}$	4.50	$3.16 \times 10^{-5}$
0.50	3.75	$1.78 \times 10^{-4}$	4.02	$1. \times 10^{-4}$
0.75	3.52	$3.0 \times 10^{-4}$	3.68	$2.1 \times 10^{-4}$
1.00	3.30	$5.0 \times 10^{-4}$	3.47	$3.4 \times 10^{-4}$
1.50	3.10	$7.95 \times 10^{-4}$	3.25	$5.6 \times 10^{-4}$
2.5	2.87	$1.35 \times 10^{-3}$	2.98	$1. \times 10^{-3}$
5.00	2.56	$2.75 \times 10^{-3}$	2.60	$2.5 \times 10^{-3}$
10.00	2.29	$5.13 \times 10^{-3}$	2.35	$4.47 \times 10^{-3}$

The values indicate that as the H-ion concentration increases, the non-quinoid amino groups in a compound such as

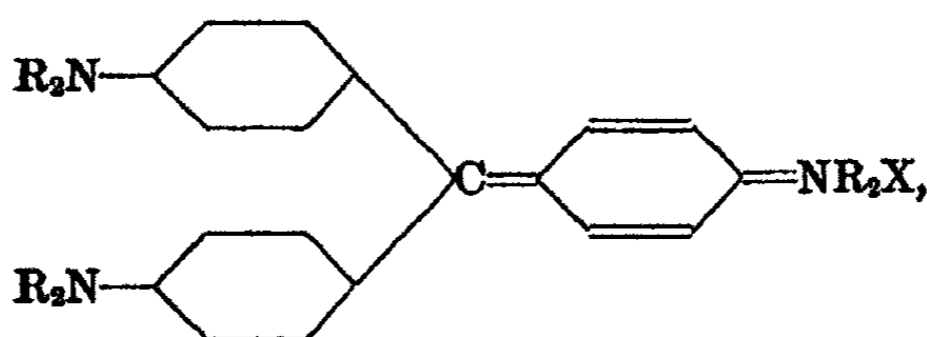

which represents the general structure of most of the basic triphenyl methane dyes, begin to function as salt formers. Further work along this line is indicated.

If the data in Table VI justify the conclusion that, with a moderate excess of dye, all of the protein combines to form a salt-like compound through a pH range extending for a significant distance on either side of the iso-

electric point, it appears highly probable that the isoelectric gelatin itself must be reactive in solution. This is not so apparent at pH's of 7, where the gelatin is about 97% in the anionic state, or 5.5, where over 50% exists as anion, but at a pH of 3.9, where only 5% is in this form, such complete combination by a single type of equilibrium shift to this anionic state prior to reaction seems highly improbable.

The probability of an "ampholyte ion" reaction is increased by the recent findings of Marinesco<sup>6</sup> who showed that gelatin molecules are highly polar, the aqueous solutions reaching a dielectric constant value of 108 for a 0.6% solution. At concentrations below this value the gelatin exists as single molecules.

For comparison of behavior, some results of similar experiments with crystal violet and nucleic acid are given in Tables VIII, VIIIA and IX, the first two tables being analogous to Tables I to IV condensed, and the last to Table VI. The acid was Eastman's yeast nucleic acid, whose ignition residue gave no appreciable tests for either sulfates or chlorides. In making calculations of some of the magnitudes in these following tables the transference number of nucleate ion in the sodium salt is somewhat arbitrarily taken as 0.33, which is probably not far wrong. The temperature of these measurements was also 28.5°C. In these titrations a 0.5% solution of the acid was used in all cases.

TABLE VIII  
Dye-Nucleic Acid

cc. nucleic acid soln. added	cond. of 500 cc. HOH plus nucleic acid $k_1$	cond. of 300 cc. HOH and 200 cc. dye soln. plus nucleic acid $k_2$	apparent cond. decrease	cond. increase from $\Delta(H^+)$ $\Delta k_R$	corrected cond. decrease $\Delta k$	cond. of dye and nucleate ions before mixing	% cond. decrease
pH — 3.9							
0	—	247.6	—	—	—	—	—
20	39.7	309.4	-22.1	82.6	60.5	74.6	81.
100	195.9	438.7	4.8	50.6	55.4	126.7	43.8
pH — 4.7							
0	—	238.7	—	—	—	—	—
20	45.6	281.	3.2	35.6	38.8	74.9	52.
100	237.4	418.	58.1	5.3	63.4	138.8	45.7
pH — 5.5							
0	—	242.0	—	—	—	—	—
25	74.34	268.3	48.0	2.0	50.0	85.3	58.6
85	247.4	368.7	120.7	0.7	121.4	143.	84.9
pH — 7.							
0	—	253.6	—	—	—	—	—
25	90.7	288.4	55.9	—	—	93.6	59.7
85	297.9	445.7	105.8	—	—	162.7	65.

TABLE VIIIA

300 cc. water plus 200 cc. dye solution titrated with 0.5% nucleic acid solution.

cc. nucleic acid soln. added	pH	(H <sup>+</sup> )	Δ(H <sup>+</sup> )	Δk <sub>H</sub>
Original pH of both dye and nucleic acid solution 3.98				
0	3.98	$1.05 \times 10^{-4}$	—	—
20	3.56	$2.75 \times 10^{-4}$	$1.7 \times 10^{-4}$	82.6
100	3.68	$2.09 \times 10^{-4}$	$1.04 \times 10^{-4}$	50.6
Original pH of nucleic acid soln. 4.68, and of dye soln. 4.70				
0	4.70	$2.00 \times 10^{-5}$	—	—
20	4.03	$9.33 \times 10^{-5}$	$7.33 \times 10^{-5}$	35.6
100	4.51	$3.09 \times 10^{-5}$	$1.09 \times 10^{-5}$	5.3
Original pH of nucleic acid soln. 5.48, and of dye soln. 5.49				
0	5.49	$3.24 \times 10^{-6}$	—	—
25	5.12	$7.59 \times 10^{-6}$	$4.35 \times 10^{-6}$	2.0
85	5.33	$4.68 \times 10^{-6}$	$1.44 \times 10^{-6}$	0.7

TABLE IX

Original pH		measured Δk	k nucleate ion	measured % cond. decrease
3.9	A	60.5	13.23	457.
	B	55.4	65.3	85.
4.7	A	38.8	15.2	255.5
	B	63.4	79.13	80.
5.5	A	50.0	24.8	202.
	B	121.4	82.5	147.2
7.0	A	55.9	30.23	185.
	B	105.8	99.3	106.6

Here, as with gelatin, combination is definitely indicated, the reaction going well toward completion. At lower pH's where the un-ionized nucleic acid predominates, the conductivity decrease is well over 100% of the conductivity of the nucleate ion. (An approximate idea can be obtained by dividing the value in column 4 by 2, assuming equal mobility of dye and nucleate ions. This per cent decrease gets lower and lower as the nucleic acid, with increasing pH, exists increasingly in ionic form, until, at pH 7, it is of the order of magnitude of 100%. Our knowledge of nucleic acid hardly justifies an attempt to calculate a theoretical value for this percent decrease.

#### Summary

1. When the basic dye ion from crystal violet and gelatin are allowed to react, disappearance of ions is observed by a decrease in conductivity of such solutions.

2. When a moderate excess of dye is used, all of the gelatin is combined.
3. This apparently complete combination takes place for a significant pH range on *both* sides of the isoelectric point of gelatin.
4. The mechanism seems to be a co-valent linking of dye cation both to gelatin anion and to an ampholyte ion, representing the principal isoelectric form of gelatin.

Except for the isoelectric behavior, the reaction between crystal violet and nucleic acid resembles that between the dye and gelatin.

6. It is thought that these results as well as those of the preceding paper are of considerable interest not only as contributing to the knowledge of protein behavior, but also in connection with the possible mechanism of certain types of *dyeing* processes.

#### References

- <sup>1</sup> W. Pauli: *Biochem. Z.*, 127, 150 (1922).
- <sup>2</sup> G. Bredig: *Z. physik. Chem.*, 13, 191 (1894).
- <sup>3</sup> W. R. Atkin and G. W. Douglas: *J. Soc. Leather Trades Chemists*, 8, 359 (1924).
- <sup>4</sup> A. E. Stearn: Unpublished data.
- <sup>5</sup> W. R. Atkin: *Proc. Leeds Phil. Lit. Soc.*, 1, 165 (1927).
- <sup>6</sup> N. Marinesco: *Compt. rend.*, 188, 1163 (1929).

*Columbia,  
Missouri.*

PHOTOCHEMICAL OXIDATION OF SALTS OF SOME ORGANIC  
ACIDS, LECITHIN, CHOLESTEROL AND SOME FOOD  
MATERIALS BY AIR 39A-108

BY C. C. PALIT AND N. R. DHAR

In previous papers<sup>1</sup> we have shown that in presence of light several carbohydrates, glycogen, nitrogenous substances, and potassium palmitate, oleate, stearate and oxalate can be oxidised by simply passing air at the ordinary temperature. We have also shown that in presence of zinc oxide the amount of oxidation of these substances is increased.

We have carried on further experiments in this line and have been able to oxidise sodium tartrate, sodium formate, citric acid, lactic acid, oxalic acid, tartaric acid, lecithin, cholesterol, butter, milk, egg-white, and egg-yellow by passing air in presence of sunlight. Moreover, we have investigated several of these photochemical oxidations in presence of ferric nitrate and uranium nitrate as photocatalysts.

In order to find out whether in presence of light the carbohydrates, fats, and nitrogenous substances are oxidised completely to carbon dioxide or other intermediate products are formed, we have estimated the amount of carbon dioxide obtained in these oxidations in potash bulbs. The amount of photochemical oxidation of these substances was in all cases also estimated by direct analysis.

We have also studied whether the Stark-Einstein Law of photochemical equivalence is applicable to the photo-oxidation of carbohydrates and nitrogenous substances. The experimental arrangement is the same as that described in a previous paper. The experimental results are recorded in Table I.

TABLE I

In each of these experiments, the volume of air passed was 36.5 litres in 5½ hours. The tartrate was estimated as potassium bitartrate and formate by the precipitation of mercurous chloride.

No. of Experiments	Substance used in the experiment	Actual weight of substance in 10 c.c. of the solution taken in grm. (Blank)	Amount of substance oxidised in grm.	Percentage amount of substance oxidised
1.	Sodium tartrate	0.0989	0.0679	31.3
2.	Sodium formate	0.07373	0.01467	19.9

The foregoing results prove that solutions of sodium tartrate and formate can be oxidised in presence of sunlight by passing air.

In recent papers<sup>2</sup> from this laboratory it has been proved that zinc oxide is a powerful photochemical sensitiser and many photochemical reactions have been accelerated by the presence of zinc oxide. We have carried on experiments on the oxidation of sodium tartrate and sodium formate in sunlight in presence of zinc oxide as photo-sensitiser. The results are as follows:—

<sup>1</sup> J. Phys. Chem., 29, 926 (1925); 32, 1263 (1928).

<sup>2</sup> J. Ind. Chem. Soc., 4, 299 (1927); J. Phys. Chem., 32, 1263 (1928).

TABLE II

In each of these experiments, the volume of air passed was 36.5 litres in 5½ hours. The weight of zinc oxide taken was exactly 0.5 gm.

No. of experiments	Substance used in the experiment	Actual amount of substance in 10 c.c. of the solution taken in gm. (Blank)	Amount of substance oxidised in gm.	Percentage amount of substance oxidised
1.	Sodium tartrate	0.0989	0.0349	64.7
2.	Sodium formate	0.07373	0.02703	35.3

The foregoing experimental results show that the amount of oxidation of sodium tartrate and formate is greater in presence of zinc oxide, which acts as a photo-sensitiser. Recently it has been shown in this laboratory<sup>1</sup> that ferric chloride and uranium nitrate markedly increase the absorption of incident radiation and hence act as accelerators of photochemical reactions. We have carried on experiments on the photochemical oxidation of carbohydrates, fats and nitrogenous and other substances in presence of ferric nitrate and uranium nitrate. The results are given in Tables III and IV.

TABLE III

Photochemical oxidation of carbohydrates, nitrogenous products, fats, and other substances in presence of ferric nitrate in sunlight.

In each of these experiments, the volume of air passed was 36.5 litres in 5½ hours. The amount of ferric nitrate taken was exactly 0.5 gm. in each case.

Substance used in the experiment	Actual amount of substance in 10 c.c. of the solution taken in gm. (Blank)	Amount of substance left after the experiment in gm.	Amount of substance oxidised in gm.	Percentage amt. of substance oxidised	Percentage oxidised in absence of catalysts
	(1)	(2)	(3)	(4)	(5)
1. Glucose	0.0962	0.0084	0.0878	91.3	14.9
2. Starch	0.1027	0.0072	0.0955	92.9	38.8
3. Glycogen	0.0987	0.0174	0.0813	82.3	19.7
4. Glycine	0.0999	0.02625	0.0735	73.7	9.6
5. α Alanine	0.0997	0.0116	0.0881	88.3	36.6
6. Hippuric acid	0.0701	0.01845	0.05165	73.65	14.2
7. Urea	0.2000	0.1800	0.0200	10.0	8.7
8. Sodium urate	0.0375	0.0090	0.0285	76.0	19.6
9. Sodium formate	0.7373	Nil	complete	100.0	19.9
10. Sodium tartrate	0.0989	"	"	"	31.3
11. Potas. stearate*	1.4	0.7	0.7	50.0	40.0
12. Potas. oleate*	5.8	3.45	2.35	40.5	31.5

\* These figures indicate the amount of absorption of  $\text{ICl}_3$  in terms of  $\text{N}/10 \text{Na}_2\text{S}_2\text{O}_3$  before and after the experiment and hence the amount of oxidation was determined.

<sup>1</sup> J. Ind. Chem. Soc., 5, 411 (1928).

TABLE IV  
Photochemical oxidation of different substances  
in presence of uranium nitrate

In each of these experiments, the volume of air passed was 36.5 litres in 5½ hours. The amount of uranium nitrate taken was exactly 0.5 gm.

	Substance used in the experiment	Actual amount of substance taken in 10 c.c. of the solution after expt. in gm. (Blank)	Amount of substance left in gm. after expt.	Amount of substance oxidised in gm.	Percentage amount of substance oxidised
1.	Glucose	0.0962	Nil	Complete	100.0
2.	Starch	0.1027	"	"	"
3.	Glycogen	0.0987	0.0678	0.1665	71.0
4.	Glycine	0.0999	0.0401	0.0598	59.75
5.	α Alanine	0.0632	0.0098	0.0534	84.5
6.	Hippuric acid	0.0680	0.0358	0.0322	47.35
7.	Sodium urate	0.0247	0.0116	0.0131	53.0
8.	Potas. oxalate	0.1030	0.0120	0.0901	87.5
9.	Sodium formate	0.07373	Nil	complete	100.0
10.	Sodium tartrate	0.0989	"	"	"
11.	Potas. stearate*	0.75	0.30	0.45	60.0
12.	Potas. oleate*	5.8	2.4	3.4	58.6

\* These figures indicate the amount of absorption of  $\text{ICl}_2$  in terms of  $\text{N}/10 \text{Na}_2\text{S}_2\text{O}_3$  before and after the experiment and hence the amount of oxidation was determined.

The experimental results recorded in the two foregoing papers show that the oxidation of glucose, starch, glycogen, glycine, α-alanine, hippuric acid, urea, sodium urate, sodium formate, sodium tartrate, potassium stearate, and potassium oleate by air is greatly increased in presence of ferric nitrate and uranium nitrate, which act as photocatalysts.

TABLE V  
Experiments with aqueous solution of organic acids  
in presence of sunlight.

The volume of air passed was 36.5 litres in 5½ hours and the volume of acid solutions taken was 10 c.c. of 1% concentration.

	Substance used in the experiment	Actual amount of acid taken in 10 c.c. of the solution in terms of $\text{N}/10 \text{NaOH}$ in c.c. (Blank)	Amount of acid left after the experiment in terms of $\text{N}/10 \text{NaOH}$ in c.c.	Amount of acid oxidised in terms of $\text{N}/10 \text{NaOH}$ in c.c.	Percentage amount of the substance oxidised
1.	Citric acid	14.3	14.05	0.25	1.75
2.	Lactic acid	8.35	8.05	0.30	3.6
3.	Oxalic acid	15.6	13.15	2.45	15.7
4.	Tartaric acid	13.25	13.0	0.25	1.9

The above results show that the organic acids can be oxidised by air in presence of sunlight at the ordinary temperature. The order in which they are oxidised is the following:—

Oxalic acid > lactic acid > tartaric acid > citric acid.

TABLE VI  
 Estimation of Carbon Dioxide  
 Experiments on the oxidation of carbohydrates, fats and nitrogenous substances in sunlight and their estimation of carbon dioxide

Substance used in the experiment	Amount of substance taken in 10 c.c. of the solution in grm. (Blank) (a)	Time of exposure in sunlight in hours (b)	Amount of CO <sub>2</sub> as found by experiment (c)	Amount of substance oxidised as calculated from the value of CO <sub>2</sub> found (d)	Percentage amount of substance oxidised (e)	Amount of substance oxidised as found by direct estimation (f)	Percentage amount of substance oxidised (g)
1. Glucose	0.1249	15	0.0144	0.0099	9.9	0.0131	10.4
2. Glycine	0.0999	11	0.0365	0.0311	31.1	0.0315	31.5
3. Potassium oleate	4.8 c.c.	9	0.0206	0.0083	8.3*	4.35 c.c.	9.3
4. Lecithin (=0.113 grm.)	4.4 c.c.	13	0.1196	0.05	50.0	2.3 c.c.	52.3
5. Cholesterol (=0.035 grm.)	1.1 c.c.	5½	0.0192	0.0062	17.8	0.2 c.c.	18.2
6. Butter (=1.0942 grm.)	5.7 c.c.	16	0.0471	—	—	3.15 c.c.	55.3
7. Milk	10.24	5½	—	—	—	1.4 c.c.	13.7
8. Egg-white (1% sol'n)	0.75 c.c.	5½	—	—	—	0.15 c.c.	20.0
9. Egg-yellow (5% sol'n)	6.7 c.c.	5½	—	—	—	3.8 c.c.	56.7

N. B. The figures from 3 to 9 in columns (a) and (f) indicate the amount of absorption of ICl<sub>4</sub> by the substances in terms of N/10 Na<sub>2</sub>S<sub>2</sub>O<sub>8</sub> before and after the experiment and the figures in 8 and 9 in the same columns indicate the amount of absorption of ammonia by the acids in term of N/10 NaOH as determined by Kjeldahl's method—before and after the experiment.

\* In the case of potassium oleate, the amount of carbon dioxide obtained by experiment was a little lower than the calculated amount and this low value may be due to the absorption of CO<sub>2</sub> by the alkali set free by the hydrolysis of potassium oleate.



TABLE VII  
Experiments on the oxidation of different substances in sunlight by air in open vessels of different superficial area.  
In each of these experiments, the volume of air passed was 36.5 litres in 5½ hours.

Substance used in the experiment	Large surface Area of the surface = 54.13 sq. cm.			Small Surface Area of the surface = 35.27 sq. cm.		
	Actual amount of substance taken in 10 c.c. of the solution in gm. before expt. (Blank)	Amount of substance left in gm. after the expt.	Percentage amount of substance oxidised	Actual amount of substance taken in 10 c.c. of the solution in gm. before expt. (Blank)	Amount of substance left in gm. after the expt.	Percentage amount of substance oxidised
1. Glucose	0.1125	0.0974	13.4	0.1125	0.1038	7.7
2. Glycine	0.09825	0.0750	23.7	0.09825	0.08925	9.2
3. Alanine	0.0845	0.0534	36.8	0.0845	0.0645	23.7
4. Lactose	0.0881	0.0681	22.7	0.0881	0.0764	13.3
5. Butter (= 1.0892 gm.)	5.66 c.c.	5.1 c.c.	9.9	5.64 (= 1.0849 gm.)	5.2 c.c.	7.8
6. Milk	10.2 c.c.	7.4 c.c.	27.5	10.2 c.c.	8.7 c.c.	14.7
7. Egg-white (5% solution)	1.6 c.c.	1.1 c.c.	31.25	1.6 c.c.	1.2	25.0
8. Egg-yellow (5% solution)	6.7 c.c.	1.75 c.c.	73.9	6.7 c.c.	2.8 c.c.	58.2

N. B. The figures in 5 and 6 indicate the amount of absorption of ICl<sub>4</sub> by the substance in terms of N/10 Na<sub>2</sub>S<sub>2</sub>O<sub>3</sub> before and after the experiment and figures in 7 and 8 indicate the amount of absorption of ammonia by the acid in terms of N/10 NaOH as determined by Kjeldahl's method—before and after the experiment. The foregoing results show that the amount of oxidation increases with the amount of light falling on the solutions

In order to find out whether in presence of sunlight the carbohydrates, fats, and nitrogenous substances are oxidised completely to carbon dioxide or other intermediate products are formed, we have estimated the amount of carbon dioxide obtained in these oxidations in potash bulbs. The amount of oxidation of these substances was in all cases also estimated by direct analysis as in previous cases, the results are shown in Tables VI-VIII.

TABLE VIII

Experiments on the oxidation of (i) glucose, (ii) glycine and (iii) potassium oleate by air in sunlight with respect to the time of exposure. (10 c.c. of glycine = 15.6 c.c. of N/12 NaOH and the absorption of ICl<sub>3</sub> by 10 c.c. of potassium oleate in terms of thiosulphate = 5.4 c.c. N/10 Na<sub>2</sub>S<sub>2</sub>O<sub>3</sub>).

Substance used in the experiment	Actual amount of the substance taken in 10 c.c. of the solution before the expt. (Blank)	Length of exposure in hours	Amount of substance left after experiment	Amount of substance oxidised	Percentage of substance oxidised
A. Glucose	0.1062 gm.	4	0.1004 gm.	0.0058 gm.	5.5
		8	0.0972 "	0.0090 "	8.5
		12	0.0960 "	0.0102 "	9.6
		16	0.0883 "	0.0179 "	16.8
B. Glycine	15.6 c.c. of N/12 Caustic soda	4	12.3 c.c.	3.3 c.c.	21.2
		8	11.2 c.c.	4.4 c.c.	28.2
		12	10.8 c.c.	4.8 c.c.	30.8
		16	9.95 c.c.	5.65 c.c.	36.2
C. Potassium oleate	5.4 c.c. of N/10 Na <sub>2</sub> S <sub>2</sub> O <sub>3</sub>	4	4.5 c.c.	0.9 c.c.	16.7
		8	4.0 c.c.	1.4 c.c.	25.9
		12	3.8 c.c.	1.6 c.c.	29.6
		16	3.2 c.c.	2.2 c.c.	40.7

The above results show that the amount of oxidation increases with the time of exposure.

#### Comparative Experiments in Sunlight

TABLE IX

Estimation of (i) glucose, (ii) glycine and (iii) potassium oleate in concentrated solution in presence of uranium nitrate in sunlight. Air was passed in all the three substances in one set of experiment simultaneously at

the same time and its volume was 320 litres in 48 hours. The amount of each of the substances taken was practically one gram and the uranium nitrate used was exactly 0.5 gram.

Substance used in the experiment	Actual amount of substance taken before the experiment (Blank)	Amount of substance left after the experiment	Amount of substance oxidised	Percentage amount of substance oxidised
1. Glucose	0.9629 gm.	0.1342 gm.	0.8278 gm.	85.0
2. Glycine	0.9990 gm.	0.2746 gm.	0.7229 gm.	72.5
3. Potassium oleate*	56.7 c.c.	16.7 c.c.	40.0 c.c.	70.5

\* The figures indicate the amount of absorption of  $\text{ICl}_3$  by potassium oleate in terms of  $\text{N}/10 \text{Na}_2\text{S}_2\text{O}_3$  before and after the experiments.

#### Comparative Experiments with Carbohydrates, Proteins, and Fats in Presence of Sunlight

TABLE X

In this experiment the volume of air passed was 60 litres in 9 hours.

Substance used in the experiment	Amount of substance taken in 10 cc. of the solution before expt. (Blank)	Amount of substance left after the oxidation	Amount of substance oxidised	Percentage amount of substance oxidised
1. Butter	5.72 c.c. (=1.10 gm.)	3.9 c.c.	1.82 c.c.	31.8
2. Egg-yellow (5% solution)	6.9 c.c. (=0.5 gm.)	2.7 c.c.	4.2 c.c.	60.9
3. Egg-white (5% solution)	1.6 c.c. (=0.5 gm.)	1.1 c.c.	0.5 c.c.	31.25
4. Starch	0.1027 gm.	0.0634 gm.	0.0393 gm.	38.2
5. Glucose	0.0962 gm.	0.0831 gm.	0.0131 gm.	13.6
6. Cane sugar	0.0964 gm.	0.0889 gm.	0.0075 gm.	7.8
7. Glycogen	0.0987 gm.	0.0913 gm.	0.0074 gm.	7.5

*N.B.* The figures in No. 1 represent the amount of absorption of  $\text{ICl}_3$  by the butter in terms of  $\text{Na}_2\text{S}_2\text{O}_3$  and in Nos. 2 and 3 the amount of absorption of ammonia by the acid—as determined by Kjeldahl's method—in terms of  $\text{N}/10 \text{NaOH}$  before and after the experiments.

The experimental results recorded in Tables VI and VII show that the amount of oxidation determined from the carbon dioxide obtained is practically the same as the oxidation found out from the direct analysis of the carbohydrates, fats, and nitrogenous substances remaining unoxidised. Hence in presence of sunlight, different carbohydrates, fats and nitrogenous substances can be completely oxidised by air at the ordinary temperature into their main end-products, carbon dioxide and water. No intermediate compounds are formed in these photochemical oxidations. We have thus been able to imitate successfully the physiological processes of oxidation on which animal life depends.

Voit in his necrology of Pettenkofer writes "that the metabolism in the body was not proportional to the combustibility of the substances outside the body, but that protein which burns with difficulty outside metabolises with the greatest ease, then carbohydrates, while fat which readily burns outside is the most difficultly combustible in the body."

We have tried to imitate the metabolism taking place in the animal body and have made comparative experiments on the oxidation of butter, egg-white, egg-yellow, starch, glycogen, glucose, and cane sugar by passing air at the ordinary temperature in presence of sunlight. The following results have been obtained:—

Egg-yellow	60.9% oxidised.
Egg-white	31.25% oxidised
Starch	38.2 oxidised.
Butter	31.8% oxidised.
Glucose	13.6% oxidised.

It appears therefore that egg-yellow is the most easily oxidisable substance in presence of light, then come starch, egg-white, and butter, while glucose is the least oxidisable. Hence eggs, which metabolise readily in the animal body, are also easily oxidized by air at the ordinary temperature in presence of sunlight.

#### Applicability of Einstein Law of Photochemical Equivalence

We have investigated whether the Einstein Law of photochemical equivalence is applicable to the photochemical oxidation of the carbohydrates, fats and nitrogenous substances in sunlight. The amount of energy absorbed by solutions of carbohydrates, fats and nitrogenous substances was estimated with the help of a Boys' radio-micrometer. The experimental results are recorded in the following tables:—

##### (A) *Glycine.*

Amount of glycine oxidised = 0.02325 gm. in  $5\frac{1}{2}$  hours in sunlight (Vide Table VIII).

Mean wavelength =  $5000\text{\AA}$

Volume taken = 100 c.c.; Area of the surface = 54 sq. cms.

		Deflection	Difference in Deflection
Distilled water	(i)	34.40	= 34.4 e.
	(ii)	34.40	
			= 0.075 cm.
Glycine	(i)	34.30	= 34.325 cm.
	(ii)	34.35	

Calculation:—

Energy per quantum corresponding to 5000 Å.  
is  $3.93 \times 10^{-12}$  ergs per second.

$$v = \frac{c}{\lambda} = \frac{3 \times 10^{10}}{5 \times 10^{-10}} = 6 \times 10^{14}$$

$$\Sigma = hv = 6.55 \times 10^{-27} \times 6 \times 10^{14} \\ = 3.93 \times 10^{-12}$$

Calibration of the scale of the radiomicrometer:—Using Hefner's lamp:—

Energy per second per square centimeter producing 1 mm. deflection is 1.5 ergs.

(i) The number of quanta absorbed by the solute per second per square cm.

$$= \frac{0.75 \times 1.5 \times 10^{12}}{3.93} = 2.8 \times 10^{11}$$

(ii) Rate of transformation of glycine molecules per second per square cm.

$$= \frac{0.02325 \times 6.06 \times 10^{23}}{330 \times 60 \times 54 \times 1000 \times 75 \times 10} \\ = 1.7 \times 10^{12}$$

$\therefore \frac{\text{The number of molecules decomposed}}{\text{The number of quanta absorbed.}}$

$$= \frac{1.7 \times 10^{12}}{2.8 \times 10^{11}}$$

$$= 7.$$

(B) Lactose.

Amount of lactose oxidised = 0.02 gm. in  $5\frac{1}{2}$  hours in sunlight (Vide Table VII).

Volume taken = 100 c.c.; Area of the surface = 54 sq. cms.

Difference in deflection for lactose = 0.1 cm.

(i) The number of quanta absorbed by the solute per second per square cm

$$= \frac{1 \times 1.5 \times 10^{12}}{3.93} = 3.8 \times 10^{11}$$

(ii) Rate of transformation of lactose molecules per second per square cm.

$$= \frac{0.02 \times 6.06 \times 10^{23}}{330 \times 60 \times 54 \times 1000 \times 10 \times 343}$$

$$= 3.3 \times 10^{11}$$

$$\therefore \frac{\text{The number of molecules decomposed}}{\text{The number of quanta absorbed}}$$

$$= \frac{3.3 \times 10^{11}}{3.8 \times 10^{11}} = \underline{\underline{0.87}}$$

(C) *Glucose.*

Amount of glucose oxidised = 0.015 gm. in  $5\frac{1}{2}$  hours in sunlight (Vide Table VII).

Volume taken = 100 c.c.; Area of the surface = 54 sq. cms.

Difference in deflection for glucose = 0.1 cm.

(i) The number of quanta absorbed by the solute per second per sq. cm.

$$= \frac{1 \times 1.5 \times 10^{12}}{3.93} = 3.8 \times 10^{11}$$

(ii) The rate of transformation of glucose molecules per second per sq. cm.

$$= \frac{.0151 \times 6.06 \times 10^{23}}{330 \times 60 \times 54 \times 1000 \times 180 \times 10} = 4.6 \times 10^{11}$$

$$\therefore \frac{\text{The number of molecules decomposed}}{\text{The number of quanta absorbed}}$$

$$= \frac{4.6 \times 10^{11}}{3.8 \times 10^{11}} = 1.21$$

(D) *Alanine.*

Amount of alanine oxidised = 0.0311 gm. in  $5\frac{1}{2}$  hours in sunlight (Vide Table VII).

Volume taken = 100 c.c.; Area of the surface = 54 sq. cms.

Difference in deflection for alanine = 0.2 cm.

(i) The number of quanta absorbed by the solute per second per sq. cm.

$$= \frac{2 \times 1.5 \times 10^{12}}{3.93} = 7.6 \times 10^{11}$$

(ii) The rate of transformation of alanine molecules per second per sq. cm.

$$= \frac{.0311 \times 6.06 \times 10^{23}}{330 \times 60 \times 54 \times 1000 \times 89 \times 10} = 1.9 \times 10^{12}$$

$$\therefore \frac{\text{The number of molecules decomposed}}{\text{The number of quanta absorbed}}$$

$$= \frac{1.9 \times 10^{12}}{7.6 \times 10^{11}} = \underline{\underline{2.5}}$$

It will be interesting to observe that the Einstein Law of Photochemical Equivalence is applicable to the photochemical oxidation of glucose, lactose, and alanine by air. The law however is not applicable to the photochemical oxidation of glycine by air where about seven molecules react per quantum of light absorbed.

The foregoing results show that practically colourless one percent aqueous solutions of glucose, lactose, glycine, and alanine can absorb light from the sunshine falling on the solutions. This absorption of energy leads to the activation of the molecules and their consequent chemical reaction with oxygen in presence of light. When these solutions are mixed with ferric or uranium nitrate, the absorption of radiation is considerably increased and the amount of oxidation is also increased.

Recently we have shown qualitatively that when substances like cholesterol and olive oil are exposed to light in presence of air, peroxides are formed and these can induce the oxidation of food materials mixed with them.

The following quantitative results have now been obtained:—

TABLE XI

Estimation of peroxide formed by passing air through mixture of (i) olive oil and water and (ii) cholesterol and water in presence of sunlight. The volume of air passed was 36.5 litres in 5½ hours. The amounts of olive oil and cholesterol taken were respectively 2.5 grms. and 1 gram. The total volume was made up to 100 cc.

(1 c.c. of N/10  $\text{Na}_2\text{S}_2\text{O}_3$  = 0.00085 gm. of  $\text{H}_2\text{O}_2$ )

Substance used in the experiment	Weight of substance taken in the expt.	Amount of N/10 $\text{Na}_2\text{S}_2\text{O}_3$ required in c.c. before passing air (Blank)	Amount of N/10 $\text{Na}_2\text{S}_2\text{O}_3$ required in c.c. after passing air	Equivalent amount of $\text{H}_2\text{O}_2$ formed in gm. from the compound of the peroxide type
1. Cholesterol	1.0 gm.	0.0	0.35	0.0002975
2. Olive oil	2.5 gm.	0.0	0.50	0.000425
3. Butter	0.932 gm.	0.0	0.30	0.000255

These experiments show that an appreciable amount of the substances of the peroxide type is formed when air is passed through the mixture of the above substances in presence of sunlight.

The results in Table XII show that appreciable amounts of glucose are oxidised by mixing it with the peroxides formed by exposing olive oil and cholesterol to light and air. Hence it is believed that the antirachitic and beneficial properties of substances not containing the necessary vitamins are due to the presence of peroxides, which help the oxidation of food materials in the animal body.

TABLE XII

To estimate the amount of oxidation of glucose by mixing with it the substances of the peroxide type formed by passing air in sunlight through (i) cholesterol and water and (ii) olive oil and water. The whole system was kept at 40° in a thermostat for 18 hours after which the estimation of glucose was made. The amounts of olive oil and cholesterol taken were 2.5 grms. and 1 gm. respectively.

Substance of the peroxide type used	Amount of glucose in gm. in 10 c.c. of the solution before experiment	Amount of glucose in gm. left after the experiment	Amount of glucose in gm. oxidised	Percentage amount of glucose oxidised
1. Olive oil and water	0.1034	0.1005	0.0029	2.8
2. Cholesterol and water	0.1034	0.1014	0.0020	1.9

#### Summary

1. Aqueous solutions or suspensions of the following substances have been oxidised by passing air in presence of sunlight:—sodium formate, sodium tartrate, lecithin, cholesterol, butter, milk, egg-white, and egg-yellow.
2. Zinc oxide acts as a photo-sensitiser in the oxidation of sodium tartrate and sodium formate and the amount of oxidation is greater than in its absence.
3. Photo-chemical oxidations of glucose, starch, glycogen, glycine,  $\alpha$ -alanine, hippuric acid, urea, sodium urate, formate, tartrate, potassium stearate and oleate is markedly increased in presence of ferric nitrate and uranium nitrate.
4. Dilute solutions of lactic acid, oxalic acid, tartaric acid and citric acid are appreciably oxidised by air in presence of sunlight and the order in which they are oxidised is:—oxalic > lactic > tartaric > citric.
5. Experimental results on the estimation of carbon dioxide prove that glucose, glycine, potassium oleate, lecithin, cholesterol, butter &c are oxidised by air in presence of sunlight chiefly to carbon dioxide and not to any intermediate product.
6. Our experimental results show that the amount of oxidation increases with (i) the amounts of light falling on the solutions and (ii) the time of exposure.
7. Comparative experiments show that the order in which the food materials are oxidised in presence of sunlight is as follows:—egg-yellow > starch > egg-white, butter > glucose.
8. The Einstein Law of Photo-chemical Equivalence is approximately applicable to the photo-chemical oxidations of glucose, lactose and alanine by air.
9. Experimental results show that appreciable amounts of the compounds of the peroxide type are formed when air is passed through aqueous



suspensions of cholesterol, olive oil and butter. Moreover, appreciable amounts of glucose have been oxidised by mixing the solutions of glucose with exposed cholesterol, olive oil and butter containing the peroxide compounds. Hence it is believed that the anti-rachitic and beneficial properties of substances not containing the necessary vitamins are due to the presence of peroxides which help the oxidation of food materials in the animal body.

*Chemical Laboratory,  
Allahabad, University,  
Allahabad, India.  
March 11, 1939.*

## CALORIMETRIC RESEARCHES

### Communication III. Technique for Adiabatic Bomb Calorimetry of High Precision

BY L. J. P. KEFFLER

In order to compare the heats of combustion of isomeric substances, a high degree of precision is essential if the determination of differences are to be of value. Preliminary studies on *o*-, *m*-, and *p*-hydroxybenzoic acids and *d*- and *l*-borneol have shown<sup>1</sup> that the differences between certain isomerides are only some 2 or 3 times the experimental error. Accordingly, the technique of the work has been changed in various particulars with a view to attaining a substantial increase in precision.

Apart from the many obstacles met with in the preparation of perfectly pure samples, the difficulties militating against accuracy in the determination of heats of combustion centre round: (1) the water equivalent, (2) the measurement of temperature differences to the same degree of accuracy as that obtainable in weighing, (3) the correction of the increase of temperature for radiation effects.

The first difficulty is overcome to a large extent by using the internationally accepted standard, namely benzoic acid of the Bureau of Standards, Washington. In this way, the results of various observers have become directly comparable.

As regards measurement of temperature differences, mercury-in-glass thermometers, even of the Beckmann type, cannot be read to better than the nearest thousandth of a degree centigrade. This requires the division at sight of the smallest interval of the Beckmann scale into twenty parts, which is of doubtful accuracy, especially when the eye gets strained. Now, for a rise of one degree, the estimation of the temperature interval within one thousandth would correspond to a relative precision of 1 in 1000 only. This degree of accuracy is quite insufficient for the problems in isomerism which it is desired to study.

There is little to be said for burning a much increased mass of substance (requiring of course a corresponding increase in the mass of oxygen) so as to secure a larger rise in temperature, because (a) such a procedure not only reduces the margin of safety for the bomb under the great strain of the increased pressure, but also increases the risk of leakage of gas through the washer, particularly after the substance has been ignited; (b) owing to the fact that Newton's law of cooling is not strictly valid for temperature intervals much exceeding one degree, the correction for heat exchanges between the calorimeter and its surroundings becomes difficult to estimate.

<sup>1</sup> *J. Phys. Chem.*, 31, 58 (1927).

The introduction in 1905 of adiabatic calorimetry was intended to overcome this obstacle.<sup>1</sup> The method used by Richards and various other experimenters for realizing adiabatic conditions is however not sufficiently elastic, especially during the period of very quick rise, to give results appreciably better than those obtained by means of the non-adiabatic method, as improved by W. P. White.<sup>2</sup> With a view of getting the conditions to remain more perfectly adiabatic, the author has devised a calorimeter the water jacket of which is heated electrolytically, using a "differential control," designed to maintain with ease the temperature of the jacket the same as that of the calorimeter within 0.01°C.

Reverting to the need for a higher precision in the temperature measurements, it should now be mentioned that the problem has been met by the substitution of the platinum-resistance thermometer for the mercury-in-glass thermometer, as indicated by E. Fischer and F. Wrede<sup>3</sup> and improved by H. Dickinson.<sup>4</sup>

A platinum resistance thermometer is however a complicated instrument permitting very little variation in the temperature of the laboratory<sup>5</sup>; the calculations for each combustion are lengthy. Furthermore, a Beckmann thermometer having normally to be substituted for the platinum one during the period of very quick change (owing to the difficulty of making electrical readings under rapidly changing conditions), an error due to the difference in lag of those two thermometers is introduced and necessitates therefore a supplementary correction. There is thus much to be said in favour of an attempt to retain the mercury-in-glass thermometer as an alternative instrument for temperature measurements of high precision so as to check the results obtained with the platinum one, and vice-versa.

For these various reasons, an effort was made to increase to about one-thousandth of a degree centigrade the normal reading of a Beckmann thermometer. This problem is claimed to have been solved successfully, as will appear from the consideration of the following table, which contains the results of the measurements carried out on the heat of stirring, under a thermal head (between the calorimeter and the jacket) to which values of the order of the maxima and minima encountered in the actual combustion experiments were successively assigned. The figures given in column 4, representing the difference between two successive thermometer readings, at intervals of five minutes, were found to be constant to  $\pm 1$  ten-thousandth of a degree for about four hours and show therefore conclusively that the temperature of the calorimeter could be read with that extreme sensitivity.

<sup>1</sup> T. W. Richards: *Z. physik. Chem.*, 52, 551 (1905); 59, 532 (1907).

<sup>2</sup> W. P. White: *J. Am. Chem. Soc.*, 40, 379 (1918).

<sup>3</sup> *Sitzungsber: preuss. Akad. Wiss.*, 1908, 1929.

<sup>4</sup> *Bull. Bur. Standards*, No. 11 (1915).

<sup>5</sup> Berner: *Archiv. Math. Natur.*, 39.

TABLE ON THE HEAT OF STIRRING

Time	Thermal Head in degrees centigr.	Temperature of calorim. in degrees Beckmann	Rise of Temperature per 5 minutes due to stirring (in ten thousandths)
1.00	0.0°C	3.8806	11
05		17	11
10		28	11
15		39	
2.05		3.8948	9
10		57	11
15		68	10
20		78	
3.45		3.8570	10
50		80	9
55		89	10
60		99	
4.50		3.8688	12
55		700	11
60		11	11
65		22	
1.25	-0.1°C	3.8874	15
30		89	18
35		907	18
40		25	
1.45		3.8620	22
50		42	20
55		62	19
60		81	
4.10	±0.1°C	3.8931	-01
15		30	00
20		30	00
25		30	
4.30		3.8685	00
35		85	00
40		85	-01
45		84	

The values given in column 4 for thermal head represent the algebraic excess of the temperature in the calorimeter over the temperature of the jacket.  
 The zero of the Beckmann scale corresponded to 15.3°C. The temperature of the emergent stem of the Beckmann thermometer was  $17 \pm 0.1^\circ\text{C}$ .

### Description of the Apparatus

The main features characteristic of the calorimetric system have been described already (*loc. cit.*). Attention will therefore be confined to improvements only.

#### 1. The heating of the jacket.

The experience gained in the combustion of readily combustible liquids showed that the rate of change of temperature in the jacket could not always be easily adjusted, by the method previously described, to keep pace with the rise in the calorimeter. Furthermore, the holes in the lead pipe (through which a practically constant mass of hot water was admitted into the jacket from a Dewar vessel) were fairly quickly blocked up by the copper mud deposited by electrolysis, thus requiring constant attention. In order to overcome these drawbacks and at the same time increase the elasticity of the method, two different power circuits were combined, each being able to supply up to 15 amps at 220 volts. The rapid variation of current required for following exactly the rise in the calorimetric temperature was easily obtained by raising or lowering two triangles of thick copper sheet in two large glass jars filled with dilute sulphuric acid. These triangles were suspended at two different levels from the surface of the acid solutions by means of leather belts passing over pulleys and joined at the far end by the same counterpoise. By this means they could be immersed simultaneously in acid by a single movement, as soon as the combustion had started, and afterwards lowered or raised together at will. After about two minutes, when the rise had nearly come to an end, the lower part only of one of the triangles was occasionally immersed for one or two seconds into the bath.

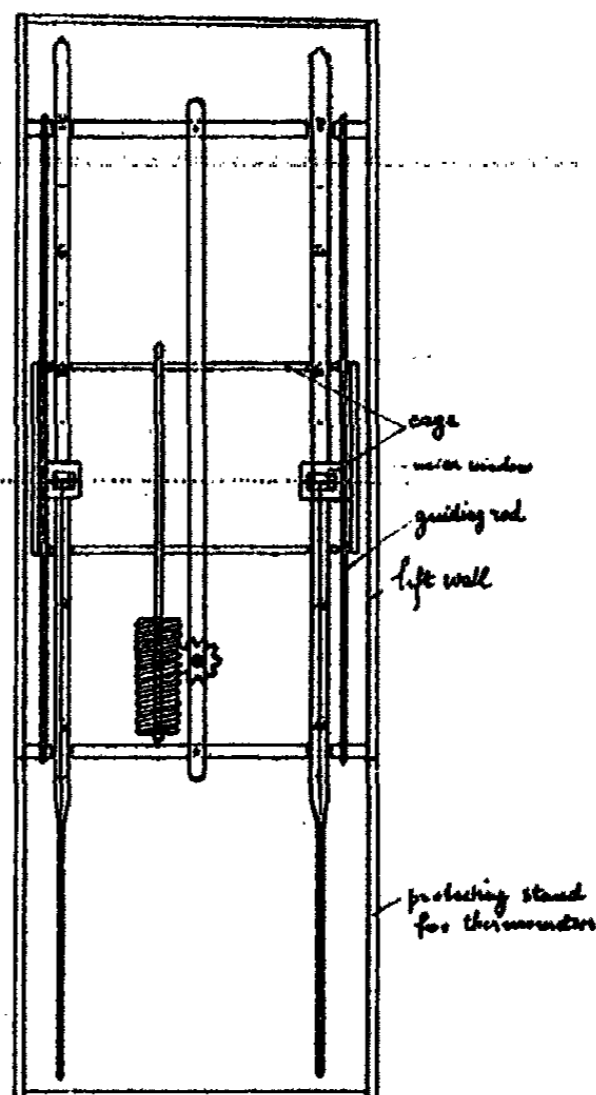

FIG. 1  
Apparatus for equalisation of temperatures

#### The Equalization of Temperature between the Calorimeter and the Jacket

In order to obtain with certainty an almost instantaneous equalisation of the jacket temperature with that of the calorimeter, and thus realise perfect adiabaticity, the following arrangement was devised (see sketch). Two long identical thermometers of similar lag, graduated in tenths, are fixed alongside one another in an oblong wooden box, with corresponding graduation in the same horizontal plane and at as small a distance as possible,

compatible with the condition that one has to be immersed in the calorimeter and the other in the jacket. The wooden box carries two vertical steel rods guiding the motion of a wooden cage capable of moving up and down like a lift and controlled from outside by means of a system of gear-, worm-, and pinion-wheels by the operator's free hand. The cage supports in front of each of the thermometers a lens with focussing arrangement and a small mica screen with a window cut out and divided into two parts by a horizontal needle. The total height of the window corresponds to one degree centigrade of the thermometric scale behind it, and the thickness of the needle has been so selected as to cover exactly the smallest graduation interval (1 tenth °C). Immediately behind the thermometers, in the same horizontal plane as the two needles (and the centres of the two lenses), two small four-volt lamps, controlled by a common switch, are fixed to the cage and permits the rise of the mercury threads to be followed easily. As soon as the bomb is fired, the cage is raised at a speed such that the needles are maintained in the horizontal plane containing the meniscus of the rising mercury threads of both thermometers. By this device it has not only been possible to keep the temperatures of the calorimeter and jacket easily within 0.1°C of each other, even when the rise was most rapid, but it has also permitted the approximate estimation at a glance of any small differences of temperature and hence instantaneous correction by reversing the small thermal head for an approximately equal time.

When extreme accuracy is required, as in the combustion of a substance proposed as an international standard, or in the cases where the heats of combustion differ only very little from one another, still more perfect adiabatic conditions were secured, at least during the fore- and after-periods and nine tenths of the main period by immersing in the jacket, alongside with the Beckmann thermometer of the calorimeter another Beckmann whose setting has been made identical within 0.01°C with that of the former.<sup>1</sup> By this means, the equalisation of temperature has been successfully realised to within 0.01°C for practically the whole of the combustion experiment.

#### The Measurement of Temperature

Temperatures were read on a Beckmann thermometer graduated to hundredths of a degree, made of Jena glass 59 III, having a very fine scale. It was calibrated in 1926 at the *Physikalische technische Reichsanstalt* to the nearest thousandth of a degree at each tenth division for three different ranges of five degrees. The bore corrections amount to  $\pm 0.002^\circ\text{C}$  for only six divisions,  $\pm 0.001^\circ\text{C}$  for twenty-one others and are nil for the twenty-four remaining ones. By its means a temperature interval can be measured with accuracy to within 0.001°C with the aid of hand lens or a telescope. As however an error of the order of one thousandth of one degree in the rise would correspond to an error of several parts in 10000 in the final result, the author endeavored to improve substantially on that sensitivity by the following

<sup>1</sup> Cohen and Moesveld: *Z. physik. Chem.*, 95, 305 (1920).

arrangement: a telescope (a) was fitted with a micrometer scale and fixed on a carriage (b) movable on a vertical stand (c) and arranged to allow by means of a screw arrangement ( $d_1$ ) a quick as well as a fine adjustment of the carriage in relation to the mercury thread of the thermometer and to permit by means of a slit ( $d_2$ ) a displacement of the objective with respect to the Beckmann so as to bring them within a distance such that ten divisions of the microscale correspond exactly to one division of the Beckmann. The smallest division of the microscale, thus corresponding to one thousandth of a degree, can then be divided at sight in ten equal parts, so that temperature differences can be directly read to the third and estimated to the fourth decimal place, i.e. within  $0.0001^\circ\text{C}$ .

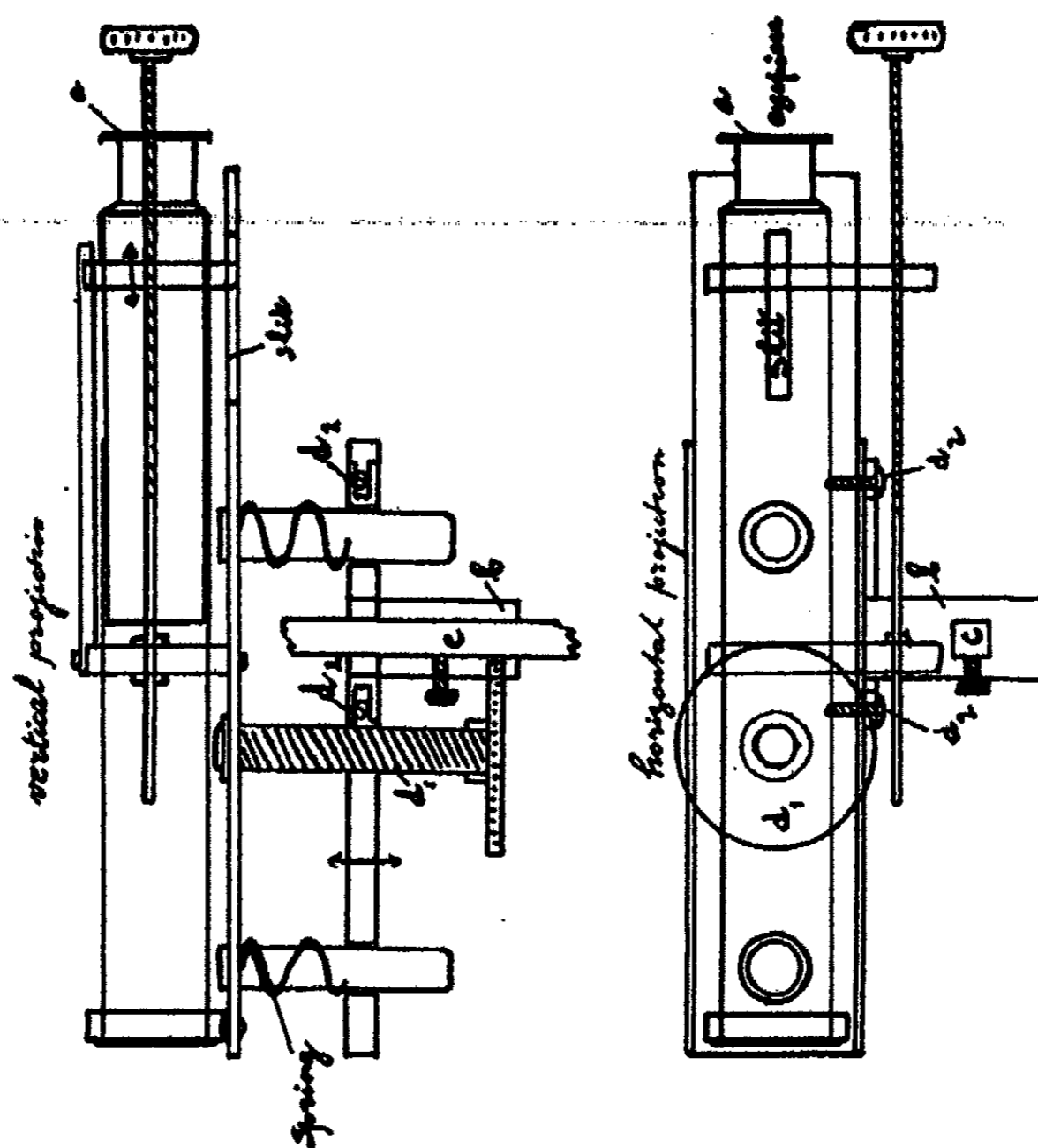

FIG. 2

Apparatus for accurate temperature measurement

In order to give however to the fourth decimal place a real meaning, in view of the fact that the calibration of the Beckmann had only been performed to the third decimal place, a special method was adopted throughout the various series of combustions (including the determination of the water-value of the calorimetric system). It consisted in burning always the same amount of substance at exactly the same initial temperature (cf. Communi-

cation I). The various advantages of that new method will be more fully discussed however in the next communication, dealing with a critical survey of the various causes of errors prevailing in adiabatic bomb calorimetry.

#### Summary

1) A short account has been given of the way in which the main difficulties in bomb calorimetry of high precision have been overcome.

2) An apparatus has been described by means of which the adiabaticity of a calorimeter could be ensured to within  $0.1^{\circ}\text{C}$  for the first minute following the ignition and within  $0.01^{\circ}\text{C}$  for the remainder of the combustion.

3) A device has been indicated which allows the accurate estimation of a temperature interval to within a ten-thousandth of a degree.

In conclusion, the author wishes to thank Professor E. C. C. Baly F.R.S. for the facilities he has kindly placed at his disposal for the carrying out of the present piece of work.

*The University,  
Inorganic Department,  
Liverpool,  
May 31, 1929.*



## THE DISSOCIATION OF STRONG ELECTROLYTES. I. OPTICAL ROTATION AND THE THEORY OF COMPLETE DISSOCIATION\*

BY MORRIS B. JACOBS AND CECIL V. KING

It is the intention of this series of papers to discuss a number of the properties of strong electrolytes which are often cited as giving evidence for complete rather than partial dissociation in aqueous solution, and show that some of them are no better evidence for the one than for the other theory. The principal points of evidence which have been given as proof of complete dissociation follow:

(1) The satisfactory character of the Debye-Hückel expression for activity coefficients in very dilute solutions and the belief that it can be extended to more concentrated solutions.

(2) The character of the curves obtained when the "osmotic deviation" is plotted against concentration.

(3) The evidence for complete ionization in crystals.

(4) Certain values for transference numbers, especially those of MacInnes.

(5) Certain values for the e.m.f. of cells, especially those of Brönsted for cells containing cadmium and magnesium sulfates.

(6) The equality of heats of neutralization for strong acids and bases.

(7) The absence of appreciable vapor pressure of the solute above dilute solutions of certain volatile substances as HCl, HBr.

(8) The experiments of Hill on the extraction of silver perchlorate from benzene by water.

(9) The supposed additivity of certain optical properties of ions, as light absorption, refraction, dispersion, etc.

(10) The supposed additivity of some other properties, as partial molal volumes, effect of ions on the activity coefficients of non-electrolytes, etc.

(11) An optical property not included in (9). The rotatory power of optically active acids, bases and salts.

The above list is by no means intended to be complete. Some other properties are admitted to disagree with the Arrhenius assumption that the degree of ionization is given by the conductivity ratio, but offer no proof of complete dissociation. These properties will not be discussed. Some of the points enumerated above are admitted by some to be rather doubtful evidence for complete dissociation, but quoted as practically conclusive proof by others. We feel that only the first two are really suitable to test adequately the theory of complete dissociation, but we wish to discuss especially points 6, 7, 8, 9 and 11, as these have often been referred to in the literature without adequate investigation.

\* Contribution from the Department of Chemistry, Washington Square College, New York University.

In this particular paper we will review some of the data on optical rotation of strong electrolytes and show that it can scarcely be referred to as a support for complete dissociation. In fact, it appears that none of those who have done so have investigated the original data, but have quoted data for only one acid and its salts, following A. A. Noyes, as will be shown immediately below.

In an address entitled "The Physical Properties of Aqueous Solutions in Relation to the Ionic Theory," delivered at St. Louis before the Section of Physical Chemistry of the Congress of Arts and Sciences in 1904, and subsequently published in "Science,"<sup>1</sup> in the Mass. Inst. Tech. "Quarterly"<sup>2</sup> and abstracted for the Zeitschrift für physikalische Chemie,<sup>3</sup> A. A. Noyes, by suggesting a theory of complete dissociation, initiated the movement to explain the "anomaly of strong electrolytes." In this address he showed how freezing point, conductivity and heat of solution data all contributed to uphold the classical theory of dissociation and also that the percent ionization seemed to be a function of the valence type of combination. Towards the end of the address, commenting on the additive properties of the ions, Noyes makes the following statement:

"Thus, the experimental data fully warrant the statement of the principle that *the optical activity and the color of salts in solution, when referred to equivalent quantities, are independent of the concentration and therefore of the degree of ionization of the salts and are additive with respect to the properties of the constituent ions even up to concentrations where a large proportion of the salt is in the un-ionized state.*"

He goes on to give Walden's values for the molar rotatory power of  $\alpha$ -brom camphor sulfonic acid and its salts in M/30 solution, and concludes his address with a very bold statement, the one usually quoted, amended by a very cautious one, which is seldom, if ever, referred to:

"If there were not other evidence to the contrary, the existence of this general principle, which is also applicable to many other properties, would almost warrant the conclusion that the salts ( $\alpha$ -brom camphor sulfonic acid and salts) are completely ionized up to the concentration in question (M/30) and that the decrease in the conductivity is due merely to a change in migration-velocity. *But in view of the apparently conclusive evidence against such a hypothesis, we can only conclude that the form of union represented by the un-ionized molecules of salts differs essentially from ordinary chemical combination, it being so much less intimate that the ions still exhibit their characteristic properties, in so far as these are not dependent upon their existence as separate aggregates.*" (Italics ours).

Since that address was delivered and published, his statement concerning optical activity data has been widely quoted as support for a 100% ionization theory by many prominent workers in this field.

<sup>1</sup> Science, 20, 577 (1904).

<sup>2</sup> Mass. Inst. Tech. Quarterly, 17, 293 (1904).

<sup>3</sup> Z. physik. Chem., 52, 634 (1905).

In their book "Thermodynamics" Lewis and Randall,<sup>1</sup> under the topic of "The Concentration of the Ions and the 'True' Degree of Dissociation," in an attempt to show that additive properties of ions support the theory of complete dissociation, say "Thus to quote A. A. Noyes, 'the optical activity and color of salts in solutions . . . are additive with respect to the properties of the constituent ions even up to concentrations where a large proportion of the salt is in the un-ionized state'." They then go on to say, "As Lewis (G. N. Lewis) has remarked, 'if we had no other criterion for the degree of dissociation, these facts would undoubtedly lead us to regard salts, up to a concentration of normal or half-normal, as completely dissociated'."

Lewis made the latter statement in an address before the American Chemical Society,<sup>2</sup> saying, "Indeed in all strong electrolytes the partial volume, heat capacity, internal energy, viscosity, refractive index, rotatory power, in fact practically all the significant properties of the undissociated part of the electrolyte seem practically identical with the properties of the constituent ions." He then concludes with the remark quoted by Lewis and Randall.

W. C. McC. Lewis,<sup>3</sup> in "A System of Physical Chemistry" under the topic of "Anomaly of Strong Electrolytes," says, "For a critical review of the question the reader should consult a paper by Noyes (St. Louis Congress Report, 1904) which also appeared in *Science*, 20, 577 (1904)."

V. K. LaMer,<sup>4</sup> in an address before the American Electrochemical Society held in Philadelphia in April, 1927, quotes Noyes "If there were not, etc.," but not giving the concluding statement. LaMer misquotes the name of the one optically active acid mentioned by Noyes, calling it " $\alpha$ -brom camphoric" instead of " $\alpha$ -brom camphor sulfonic acid."

In the "Polyologist" published by the Chemistry Society of the Brooklyn Polytechnic Institute,<sup>5</sup> a résumé was printed of LaMer's address, and LaMer was quoted, quoting Noyes.

Again, Creighton and Fink<sup>6</sup> in their book "Electro-chemistry" say in a footnote:

"For a summarized description of phenomena which appear to substantiate the hypothesis of complete dissociation, see A. A. Noyes: *Science*, 20, 582 (1904); *J. Am. Chem. Soc.*, 30, 582 (1908)."

(The latter reference is incorrect. Page 582 should probably be 335 and this article refers back to the one in *Science*.) But the only data Noyes actually presented in this paper which could be interpreted as a support for complete dissociation was the optical activity of the one acid,  $\alpha$ -brom camphor sulfonic acid, and its salts.

<sup>1</sup>"Thermodynamics," 319 (1923).

<sup>2</sup>"The Use and Abuse of the Ionic Theory." *Z. physik. Chem.*, 70, 212 (1909).

<sup>3</sup>"A System of Physical Chemistry," 1, 225 (1926).

<sup>4</sup>*Trans. Electrochem. Soc.*, 51, 507 (1927).

<sup>5</sup>*Polyologist*, Brooklyn Polytechnic Institute (1929).

<sup>6</sup>"Electrochemistry," 316 (1928).

The above references show how the original statement of Noyes has been quoted and requoted and stripped of its guarding sentences until the impression is conveyed that some of the most important evidence to substantiate the complete dissociation hypothesis is optical activity data.

Let us review a few of the facts about optical rotation. The specific rotation ( $\alpha$ ) is given by:

$$(\alpha) = \frac{100 \alpha}{lc}$$

where  $\alpha$  is the rotation observed in degrees,  $l$  the length in decimeters of the tube used, and  $c$  the concentration of the active substance in grams per 100 cc. The molecular (or equivalent) rotation is usually given as

$$(\alpha_M) = \frac{M (\alpha)}{100} = \frac{M \alpha}{lc}$$

where  $M$  is the molecular (or equivalent) weight of the active substance.  $(\alpha_M)$  is thus the rotation per mole (or per equivalent) per 100 of solution for a column 1mm long; or per mole (or equivalent) per liter of solution for a column 1 meter long. The rotation is generally given for monochromatic light (usually the sodium line or one of the mercury lines) and change in rotation for different wave lengths will not be discussed here.

To connect optical rotation with degree of ionization it is necessary first of all to consider that each active molecular and ionic species present has its own individual and constant molecular rotation. That is, in a solution containing the active species tartaric acid, tartrate ion, potassium tartrate molecules, each of these must be assumed to have its own molecular rotation which does not change on dilution or addition of inactive salts. That this is strictly true is doubtful, except for salts of optically active strong acids and bases where there is no possibility of disturbing influences such as hydrolysis, association, intra-molecular shifts, etc. It may be possible that Noyes, either with extreme foresight or fortuitously, picked the only case recorded in the literature that meets the necessary requirements. However, the above principle has been assumed to be true in the case of many optically active substances, even sugars, nucleic acids, amino-acids etc., where rotation curves as the weak acid or base is neutralized have been found to parallel titration curves.<sup>1</sup>

Assuming that the above principle is true, to be interpreted in favor of complete dissociation the behaviour of optically active electrolytes should fulfill two requirements: (1) different salts of the same acid or base should show the same equivalent rotation at corresponding dilutions; and (2) the equivalent rotation should remain constant at all dilutions. The above, at least, is true if the rotation depends only on the concentration of the active substance and not on its activity (or activity coefficient); this question has not been adequately discussed in the literature.<sup>2</sup> At any rate, Noyes, in

<sup>1</sup> See, for example, *J. Biol. Chem.*, 70, 243 (1926); 72, 815 (1927); *Compt. rend.*, 183, 195 (1926); *J. Am. Chem. Soc.*, 39, 968 (1917); *J. Chem. Soc.*, 105, 1988 (1914).

<sup>2</sup> See however, *Liquier: Ann. Phys.*, 8, 121 (1927).

quoting the data for  $\alpha$ -brom camphor sulfonic acid evidently had in mind that it and its salts fulfilled the first requisite mentioned.

Landolt, in his book "The Optical Rotation of Organic Compounds" (1902) gives an extended discussion of ionization and optical activity (§61). In this are included Walden's<sup>1</sup> data on  $\alpha$ -brom camphor sulfonic acid and its salts, which was quoted by Noyes in 1904. However, a review of this and the other data in this book, as well as the work on optical rotation done since, makes it apparent that accepting the data as support for the hypothesis of complete dissociation is making an unwarranted leap to a preconceived conclusion.

There are a number of salts that approximately at least fulfill the first requirement given above. But constant specific rotation with changing dilution (and hence constant equivalent rotation) is rare. It is shown by a few non-electrolytes, and approximately at least by the salts of a few acids and bases, as those of  $\alpha$ -brom camphor sulfonic acid, tartaric acid, strychnine. These do, however, show a small change with dilution; and the specific rotation of most substances changes significantly on dilution. There is no general rule for this change, the rotation of some substances decreasing and that of others increasing. Salts as well as non-electrolytes may show a decrease or an increase. Thus potassium and sodium tartrates show opposite behaviours on dilution.<sup>2</sup> With alkaloids and their salts, increase in rotation as concentration decreases is the usual phenomenon.

At the time Landolt's book appeared, changes in optical rotation could by no means all be ascribed to changes in degree of ionization. Some of the causes of change in specific rotation, as given by Landolt, are:

- 1). Change in electrolytic dissociation.
- 2). Formation or decomposition of molecular aggregations.
- 3). Presence of polymerized molecules.
- 4). Combination of active body with solvent.
- 5). Hydrolysis.
- 6). Small variations in atomic equilibrium of active molecules.

Walden<sup>3</sup> showed, as Noyes points out in his article, that ( $\alpha_M$ ) of the acid, K, Tl, Zn and Ba salts of  $\alpha$ -brom camphor sulfonic acid are approximately the same in N/30 solution. From this Noyes makes his assumption of the possibility of 100% dissociation. But the work of Walden shows if anything that this is a limiting condition which is reached only upon dilution. The rotation of almost every salt mentioned shows a small but probably significant change in rotation as the concentration is changed from N/30 to N/120. This change is far greater with most active salts, as is shown for example by the work of Hädrich,<sup>4</sup> who measured the rotation of salts of active alkaloid bases as morphine hydrochloride, nitrate, sulfate, quinine and cinchonidine salts, etc. The value of ( $\alpha_M$ ) for quinine hydrochloride, for instance, changes

<sup>1</sup> Walden: *Z. physik. Chem.*, 15, 196 (1894).

<sup>2</sup> Landolt: *loc. cit.* pp. 203, 204, 205.

<sup>3</sup> *loc. cit.*

<sup>4</sup> *Z. physik. Chem.*, 12, 476 (1893).

from  $-546^\circ$  at  $M/20$  to  $-587^\circ$  at  $M/120$ . The limiting value, and indeed the value at each concentration, is approximately the same for all salts of the same base, but if this is significant with respect to dissociation it means that all the salts are nearly equally ionized at the same dilution. Hädrich reached the conclusion that at such dilutions that dissociation is approximately complete, the rotatory power is in general independent of the inactive ion. Hädrich found only a few cases where the rotation is independent of the dilution as well as of the inactive ions, as the salts of strychnine, four of which have the rotation  $-113^\circ$  or  $-114^\circ$  at concentrations  $N/22$ ,  $N/33$ , and  $N/40$ .

An extension of Hädrich's conclusions to explain the behaviour of the  $\alpha$ -brom camphor sulfonic acid and salts is that the metallic radical has little influence whether actually combined with the optically active radical or not. The fact that the rotatory power is nearly independent of the dilution does not necessarily imply complete dissociation or dissociation such as postulated by Noyes but rather that the metallic radical has little effect on the optical activity whether it is an ion or is combined in a molecule as complicated as the  $\alpha$ -brom camphor sulfonic acid radical. Exactly this behaviour is shown in some cases where there is no question of appreciable dissociation. For example, the ethyl, propyl and butyl acid esters of ortho-camphoric acid show practically identical molecular rotations in alcohol solution and the change in rotation between 0.4 and 0.2 M is negligible. In benzene the rotation of each is different, but again identical for the three esters and for the two concentrations.<sup>1</sup>

Incidentally, the work of Pope and Read<sup>2</sup> shows that some difficulty may be experienced in preparing samples of the salts of  $\alpha$ -brom camphor sulfonic acid of the same tautomeric form, and casts some doubt on the validity of Walden's evidence that the various salts show the same equivalent rotation. It should not be forgotten, too, that accurate rotation measurements are difficult for dilute solutions.

C. Bongiovanni<sup>3</sup> determined the electrical conductivity and rotatory power of solutions of potassium tartrate diluted to a certain volume in one case with water and in the other with a solution containing potassium nitrate or sulfate. The conductivity of the latter mixture was less than the sum of the conductivities of the two components, whereas the rotatory power remained the same. This can be interpreted in favor of complete dissociation which is not affected by addition of a common ion; or interpreted as it is by the author, to indicate that the rotation is independent of the dissociation. Potassium tartrate, it should be noted, is one of the few exceptions to the general rule that the equivalent rotation changes markedly with dilution. Therefore Bongiovanni's data mean little for one theory or the other.

Shinn<sup>4</sup> measured the equivalent rotation of the nitrates, sulfates and chlorides of alkaloids in dilute aqueous solution. The optical rotations do

<sup>1</sup> Minguin and Bloc: *Compt. rend.*, 158, 1273 (1914).

<sup>2</sup> *J. Chem. Soc.*, 105, 800 (1914).

<sup>3</sup> *Gazz.*, 42 I, 179 (1912).

<sup>4</sup> *J. Phys. Chem.*, 11, 201 (1907).

not tend to become identical for salts of the same base at infinite dilution (except perhaps in the case of strychnine salts). The others diverge at high dilution, some increasing, some decreasing. He was unable to harmonize his results with the classical dissociation theory and obviously not with a hypothesis of complete dissociation.

Winther<sup>1</sup> concludes that change in optical rotation is due to volume changes and hence unless dissociation alters the volume of the active substance it will not affect the rotatory power.

Scheuer<sup>2</sup> in physical chemical studies of binary mixtures with one optically active component came to the conclusion that the observed influence of solvent and concentration on the rotation is not due to the formation of compounds with the solvent but must be due to tautomerism, dissociation, polymerization, or deformation of molecules.

The following references show that the rotatory power of weak acids and bases is influenced by the concentration of hydrogen ion, and consequently by the degree of ionization; thus indicating that the many salts whose rotation changes with dilution undergo a change in degree of ionization.

Liquier<sup>3</sup> showed that the rotatory power of solutions of asparagine is the same for the same pH whatever acid or base is used, thus indicating a close relationship between the rotatory power and the degree of ionization.

Liquier<sup>4</sup> demonstrated that in aqueous mixtures of dilute acids or bases, the rotatory power of the optically active, weak electrolytes nicotine, quinine and asparagine is a function of  $C_{H^+}$  and therefore of the state of dissociation.

Vlés and Vellinger<sup>5</sup> showed that the rotation of tartaric acid changes remarkably between pH 2 and 5, remaining thereafter approximately constant until pH 13 is reached. The rotation apparently follows the concentration of tartrate ion. The fact that the rotation is nearly constant between pH 5 and 13 is not significant when it is remembered that tartrates are exceptions in that their equivalent rotation is nearly independent of the dilution.

Biddle<sup>6</sup> determined the rotation of the chinchona alkaloids in acid solutions. In all cases, he found, rotation increases with increasing concentration of bivalent alkaloid ion. The increase is strictly proportional to the calculated concentration of the bivalent alkaloid ion and independent of the inactive acid ion.

Darmois<sup>7</sup> showed that  $(\alpha)$  for tartaric acid increases with the concentration in  $CaCl_2$  solution. pH measurements of these solutions show a higher hydrogen ion concentration in  $CaCl_2$  solution than at the same dilution in water. The increase in  $C_{H^+}$  is parallel to the increase in  $(\alpha)$ . The variation in  $(\alpha)$  is thus ascribed to formation or disappearance of tartrate ion.

<sup>1</sup> Z. physik. Chem., 60, 590 (1907).

<sup>2</sup> Z. physik. Chem., 72, 513 (1910).

<sup>3</sup> Compt. rend., 180, 1917 (1925).

<sup>4</sup> Ann. Phys., 8, 121 (1927).

<sup>5</sup> Compt. rend., 180, 742 (1925).

<sup>6</sup> J. Am. Chem. Soc., 39, 968 (1917).

<sup>7</sup> Compt. rend., 184, 1438 (1927).

Since this paper was written, two pieces of work which have an important bearing on this problem have come to our attention. Walden has measured the molecular rotation of tetra ethyl ammonium  $\alpha$ -brom camphor  $\pi$  sulfonate (a typical highly ionized salt in water) over a wide range of concentrations in many solvents of widely divergent dielectric constants, and for comparison has also measured the rotation of  $\alpha$ -brom camphor sulfonic acid chloride in the same solvents.<sup>1</sup> Each of these, the salt and the non-electrolyte, shows no change in molecular rotation (within about  $\pm 2\%$ ) with dilution in any of the following solvents: water, ethyl alcohol, *n*- and *iso*-butyl alcohols, acetic anhydride, aceto-nitrile, chloroform, a mixture of chloroform and benzene, tetra-chlor ethane, and a mixture of carbon disulfide and ethyl alcohol. The characteristic value of  $\alpha_m$  is different in each solvent, however. Since the salt cannot be completely dissociated in all these solvents, Walden reaches the conclusion that the active ion shows the same rotation whether it is "free" or a "latent ion" in this hetero-polar molecule.

Mr. Neil Campbell, of the University of Edinburgh, has measured the rotation of ammonium  $\alpha$ -brom camphor  $\pi$  sulfonate in water solution, in the presence of many other electrolytes and non-electrolytes. This salt was especially chosen for its high rotation and for its freedom from various factors that would make it objectionable to use in testing the applicability of optical rotation data as a measure of ionization, and the rotation was measured with all possible accuracy. While the results of this work are unavailable at present, Mr. Campbell has been so kind as to send us a resumé of the important features. The results are such as to exclude any simple interpretation in favor of the complete dissociation theory, and indeed make it appear that with our present knowledge of optical rotation such data gives us no indication of the real degree of ionization.

#### Summary

It has been shown above that comparatively few optically active strong electrolytes behave in such a way that rotation data can be interpreted in favor of complete dissociation except as a limiting condition at high dilution. Those who have claimed that such data support the theory of complete dissociation have apparently gone no further than to requote the data Noyes quoted in 1904, on the optical activity of one acid and its salts.

Although the theory of complete dissociation may be the best explanation of the anomaly of strong electrolytes in aqueous solution, as certain other facts seem to indicate, optical rotation data offer little if any support for the theory at the present time.

New York, N. Y.

<sup>1</sup> Monatsheft, 53-54, 14 (1929).



## THE COLOR OF ARSENIC TRISULFIDE

BY HARRY B. WEISER

Arsenic trisulfide precipitates as a citron-yellow flocculent mass on passing hydrogen sulfide into a solution of arsenic trioxide acidified with hydrochloric acid. When dried, the salt prepared in this way is an impalpable yellow powder. Twenty-five years ago Winter<sup>1</sup> prepared what he called a red allotropic modification of arsenic trisulfide by freezing or evaporating the hydrosol or by coagulating the hydrosol by a salt or acid followed by drying. In recent years the observations and conclusions of Winter have been opened to question as a result of the work of Semler<sup>2</sup> and of Bhatnagar and Rao.<sup>3</sup> Semler was unable to prepare a red sulfide except by coagulating the arsenic trisulfide sol with an electrolyte which was believed to give a red sulfarsenite. Thus a red preparation was obtained by coagulating the sol with barium chloride but not with sodium chloride. Bhatnagar and Rao claim that the red preparation is not the trisulfide  $As_2S_3$  but the disulfide  $As_2S_2$ .

Winter's view that the yellow and red sulfides are allotropic modifications resulted from the observation that the red preparation changes to yellow on standing for a long time at room temperature or by prolonged heating at  $150^{\circ}$ - $160^{\circ}$ . He could not establish the existence of an inversion point, however, and the color change is exactly the reverse of that observed by Borodowsky.<sup>4</sup> The latter reported that the yellow form was stable up to a temperature of  $170^{\circ}$  where it changed to red.

Semler's conclusion that the red color obtained by coagulating arsenic trisulfide sol with barium chloride, is due to the formation of red  $Ba_2As_2S_6$ , lacks experimental justification. In the first place, there is no direct evidence of the formation of any  $Ba_2As_2S_6$  on adding barium chloride to a purified arsenic trisulfide sol. In the next place the color of barium sulfarsenite is apparently not such as to mask the yellow color of the sulfide with red. Berzelius<sup>5</sup> describes the sulfarsenite of barium as a gummy reddish-brown mass which dissolves completely in water giving a colorless solution. Nilson<sup>6</sup> on the other hand, characterizes the pyrosulfarsenite,  $Ba_2As_2S_6 \cdot H_2O$ , as greyish green in color, changing to indigo-blue when allowed to remain in contact with the mother liquor for some time. The blue color is probably due to colloidal sulfur dispersed in the salt.<sup>7</sup> The orthosulfarsenite is described as slightly soluble, pale yellow prisms which would have little effect on the yellow color of arsenic trisulfide. Finally, if one admits that barium sulfar-

<sup>1</sup> Z. anorg. Chem., 43, 228 (1905).

<sup>2</sup> Kolloid-Z., 34, 209 (1924).

<sup>3</sup> Kolloid-Z., 33, 159 (1923).

<sup>4</sup> Chem. Zentr., 1906 II, 297.

<sup>5</sup> Pogg. Ann., 7, 142 (1826).

<sup>6</sup> J. prakt. Chem., (2) 12, 295 (1875); 14, 145 (1876); 16, 931 (1877).

<sup>7</sup> Cf. Mellor: "Inorganic and Theoretical Chemistry," 9, 296 (1929).

senite is formed on adding barium chloride to arsenic trisulfide sol and that the color of the sulfarsenite is red, there is no justification for assuming that sufficient amount will be retained by the sulfide to impart a distinct red color to the latter. It has been demonstrated that but 0.1 of a milliequivalent of barium is adsorbed per gram of  $As_2S_3$  during coagulation of the trisulfide sol.<sup>1</sup> This adsorbed barium is probably associated chiefly with  $HS'$  and  $S''$  ion on the sulfide and not with sulfarsenite anion. Even if one makes the improbable assumption that all of the barium is present as  $Ba_2As_2S_6$ , there would be but 1 mol of sulfarsenite to 160 mols of trisulfide.

Bhatnagar and Rao's contention that the red sulfide is  $As_2S_3$  and not  $As_2S_5$  is based largely on the results of an analysis of a red product formed by coagulating an  $As_2S_3$  sol, freed from hydrogen sulfide and kept in the dark. It is not obvious how  $As_2S_5$  would be formed under these conditions and the conclusion has been questioned.<sup>2</sup>

In view of the unsatisfactory nature of the explanations that have been advanced to account for the wide variation in color of precipitated arsenic trisulfide, the experiments to be described in the next section were carried out.

#### The Color of Arsenic Trisulfide Sols

The color of arsenic trisulfide sol varies from orange to yellow, depending on the size of the particles and the concentration. A sol with very small particles appears more orange than one of the same concentration containing larger aggregates. A concentrated sol always appears more yellow than a dilute one because of the larger aggregates in the latter. Light destabilizes the sol<sup>3</sup> so that a red-orange sol agglomerates on standing in the light, becoming more yellow in color, and finally precipitating out. The properties of sols of several concentrations when first formed and after 4 months, are given in Table I. Two hundred cubic centimeter portions of the several sols were pre-

TABLE I  
Properties of  $As_2S_3$  Sols

Concn. of sol $As_2S_3$ , per liter grams	Color	Appearance in reflected light	Precipitate
(a) Immediately after forming			
0.17	Greenish yellow (orange in thick layers)	Clear	None
0.87	Orange yellow	Clear	None
1.74	Light orange	Slightly opalescent	None
4.35	Orange	Opalescent	None
8.70	Orange (deeper)	Cloudy	None
17.40	Deep orange	Very cloudy	None

<sup>1</sup> Linder and Picton: *J. Chem. Soc.*, 67, 64 (1895); Whitney and Ober: *J. Am. Chem. Soc.*, 23, 842 (1901); Weiser: *J. Phys. Chem.*, 29, 955 (1925).

<sup>2</sup> Cf. Bikerman: *Z. physik. Chem.*, 115, 261 (1925).

<sup>3</sup> Young and Pingree: *J. Phys. Chem.*, 17, 675 (1913).

TABLE I (Continued)

Concn. of sol $As_2S_3$ per liter grams	Color	Appearance in reflected light	Precipitate
(b) After standing 4 months in the dark			
0.17	Greenish yellow (orange in thick layers)	Clear	Trace of S
0.87	Orange yellow	Slightly opalescent	Trace of S
1.74	Light orange	Slightly opalescent	Trace of S
4.35	Orange	Slightly cloudy	Trace of S
8.70	Orange (deeper)	Cloudy	Some S
17.40	Yellow orange	Very cloudy	Considerable S and $As_2S_3$
(c) After standing 4 months in the light			
0.17	Colorless	Clear	S
0.87	Sulfur sol	Cloudy	S and a little $As_2S_3$
1.74	Sulfur sol	Cloudy	S and a little $As_2S_3$
4.35	Orange yellow	Cloudy	Sand $As_2S_3$
8.70	Yellow orange	Cloudy	S and $As_2S_3$
17.40	Yellow orange	Cloudy	Sand $As_2S_3$

pared by conducting hydrogen sulfide into arsenic trioxide solutions. The samples were divided, one portion being placed in a 250 cc Erlenmeyer flask, tightly stoppered and stored in the dark while the second portion was stoppered loosely and allowed to stand in a well-lighted laboratory. All preparations were clear in transmitted light; hence the appearance in reflected light only, is given in the table.

From the above observations it is clear that even fairly concentrated sols are quite stable if kept in the dark out of contact with air. The same sols in the air and light are not only sensitized but the sulfide is decomposed and sulfur is precipitated. In the first three sols the decomposition is complete within four months. Most of the sulfur precipitates but a part remains in the sol state. It is probable that the yellow color which the trisulfide sol assumes on exposure to light is due not only to agglomeration of sensitized particles into clumps but to the simultaneous formation of sulfur sol. The yellow color of an aged sol or a highly concentrated sol is the color by reflected light. A thin layer of even a very highly concentrated sol appears orange by transmitted light and a thick layer of a highly dilute sol is likewise orange by transmitted light. In this connection it should be mentioned that the voluminous coagulum from an orange sol appears yellow by reflected light but dries to a red glassy mass.

Freundlich and Nathansohn<sup>1</sup> attribute the action of light on arsenic trisulfide sols to the photochemical oxidation of the hydrolysis product—hydrogen sulfide—to colloidal sulfur and pentathionic acid, accompanied by a reaction between hydrogen sulfide and pentathionic acid which serve as the stabilizing electrolytes for arsenic trisulfide and sulfur respectively. Bhatnagar and Rao, on the other hand, believe that light changes red disulfide into yellow trisulfide in accord with the following reactions:  $\text{As}_2\text{S}_3$  (red) +  $x\text{H}_2\text{S}$  +  $x\text{O} = \text{As}_2\text{S}_3$  (yellow) +  $x\text{H}_2\text{O}$  +  $(x - 1)\text{S}$ , if  $\text{H}_2\text{S}$  is in excess; and,  $\text{As}_2\text{S}_3$  (red) +  $\text{H}_2\text{S}$  +  $\text{O} = \text{As}_2\text{S}_3$  (yellow) +  $\text{H}_2\text{O}$ , if but little  $\text{H}_2\text{S}$  is present. This explanation of the action of light and air is based on the assumption that the familiar orange sol formed by conducting hydrogen sulfide into arsenic trioxide solution, is the disulfide rather than the trisulfide.

#### The Color of Precipitated Arsenic Trisulfide

*Precipitation of  $\text{As}_2\text{S}_3$  in the Presence of Foreign Electrolytes.* To determine the effect of the presence of certain electrolytes on the color of arsenic trisulfide during the process of precipitation, the following experiments were carried out: To solutions of arsenious oxide were added definite amounts of several electrolytes and the mixture treated with hydrogen sulfide. The gas was bubbled through the solutions at a constant rate for five minutes which was sufficient to cause complete precipitation in all cases. The precipitates were transferred to a filter, washed by the aid of suction and dried in a vacuum desiccator over sulfuric acid. The observations which are recorded in Table II disclose that the dried sulfide has a distinct orange tint when precipitated in the presence of neutral electrolytes. The shade is almost the same with all the salts. Thus the eye cannot distinguish any difference in the color of the sulfide formed in the presence of barium chloride from that

TABLE II

Color of  $\text{As}_2\text{S}_3$  precipitated in the Presence of Foreign Electrolytes.

Solutions with $\text{H}_2\text{S}$			Color of $\text{As}_2\text{S}_3$
$\text{As}_2\text{O}_3$ 14 g per l cc	Electrolyte N/2	$\text{H}_2\text{O}$ cc	
25	10 cc LiCl	15	Orange yellow
25	10 cc NaCl	15	Orange yellow
25	10 cc KCl	15	Orange yellow
25	10 cc $\text{NH}_4\text{Cl}$	15	Orange yellow
25	10 cc $\text{BaCl}_2$	15	Orange yellow
25	10 cc $\text{CaCl}_2$	15	Orange yellow
25	10 cc HCl	15	Yellow
25	10 cc HCl + 10 cc $\text{BaCl}_2$	5	Yellow
25	5 cc HCl + 10 cc $\text{BaCl}_2$	15	Yellow

<sup>1</sup> Kolloid-Z., 28, 258 (1921).

formed in the presence of potassium chloride or ammonium chloride. The precipitate thrown down in the presence of hydrochloric acid is the familiar yellow irrespective of whether barium chloride is present or absent.

*Coagulation of  $As_2S_3$  Sol with Electrolytes.* 175 cc of arsenious oxide solution containing 14 grams per liter were diluted with 105 cc of water and converted into the sol by conducting hydrogen sulfide through the solution. Portions of 40 cc each were then coagulated by the addition of the several electrolytes given in Table III, and the precipitates washed and dried in a vacuum desiccator. The same amount of salt was precipitated in each case as in the preceding experiment. It is evident that the color of arsenic trisulfide thrown down from sol is red rather than yellow, irrespective of the nature of the precipitating electrolyte. The orange red obtained with all of the neutral salts was the same shade showing that the color is not due to a colored sulfarsenite such as Semler assumed. Moreover the color is a somewhat darker red when the coagulation is accomplished with hydrochloric acid which would promptly destroy any sulfarsenite.

TABLE III

Color of  $As_2S_3$  from Coagulation of Sol.

$As_2S_3$ cc	Coagulating electrolyte N/2	Color of dried precipitate
40	10 cc LiCl	Orange red
40	10 cc NaCl	Orange red
40	10 cc KCl	Orange red
40	10 cc $NH_4Cl$	Orange red
40	10 cc $BaCl_2$	Orange red
40	10 cc $CaCl_2$	Orange red
40	10 cc HCl	Red

A few experiments were carried out starting with a solution of sodium hydrogen arsenite instead of arsenious oxide. The nature of the experiments and the results are given in Table IV.

TABLE IV

Color of  $As_2S_3$  from  $Na_2HAsO_3$  Solution.

Solutions used			Method of procedure	Color of sulfide
$Na_2HAsO_3$ 25 g per l cc	Electrolyte	$H_2O$ cc		
20	15 cc 2.3 N HCl	130	$H_2S$ added to mixture	Yellow
20	15 cc 2.3 N HCl	130	Arsenite first converted into $As_2S_3$ sol and coagulated	Red
20	25 cc N/2 $BaCl_2$	120	$H_2S$ added to mixture	Orange yellow
20	25 cc N/2 $BaCl_2$	120	Arsenite first converted into $As_2S_3$ sol and coagulated	Brown red

*Coagulation of  $As_2S_3$  by Freezing.* A sol formed by conducting hydrogen sulfide into arsenious oxide solution was coagulated by freezing and the precipitate collected and dried in a vacuum desiccator. It was granular rather than glassy in character and orange red in color.

*Effect of Light on Red  $As_2S_3$ .* Winter reports that the red trisulfide changes to yellow on standing. This change in color was observed but it was noted that light was necessary for the change. A sample kept in the dark six months underwent no change in color whatsoever while a sample exposed to light in either a glass or quartz vessel was coated over with a yellow film in a few hours. Even long exposure produced but a thin film and this resulted only on the exposed surface of the granules. It was suspected that the action was similar to one which takes place in the sol and that moisture was necessary for the process. This was found to be the case; a thoroughly dried sample sealed up to exclude all moisture was not affected by sunlight.

A sample coated with a yellow film by prolonged action of light with repeated shaking to expose fresh surfaces was extracted with redistilled  $CS_2$ . On evaporating the solvent, a relatively large deposit of sulfur was obtained. The yellow film is thus a mixture of sulfide and sulfur just as the cloudy yellow (by reflected light) sol and precipitate formed by the action of light on a clear orange sol, are sulfide and sulfur.

Contrary to Semler's observation, red sulfide obtained by precipitating the sol with barium chloride turns yellow superficially. Semler's failure to observe this change was undoubtedly due to thorough drying of the sample or to protecting it from light.

*Effect of Heat on Red  $As_2S_3$ .* Samples of the red sulfide were prepared by coagulating the sol with hydrochloric acid and with barium chloride. The two samples were thoroughly washed by decantation until partially peptized, filtered on a Gooch crucible, washed, dried and heated over night to  $160^\circ$ . Both samples turned yellow in color confirming Winter's observations.<sup>1</sup> As we shall see, this color change is probably due to a change in structure of the precipitate rather than to allotropy.

The powdery yellow sulfide heated to  $175^\circ$  and above sinters, contracts, and assumes an orange to brown color depending on the duration of heating and the temperature.

*Effect of Grinding Red  $As_2S_3$ .* Grinding the granular brick-red sulfide in an agate mortar converts it into a yellow powder having but a slight orange tint.

#### Composition

Bhatnagar and Rao's view that the red arsenic sulfide is  $As_2S_2$  rather than  $As_2S_3$  called for further consideration. To test this, four 0.2-gram samples of Diack and Smith's arsenic trioxide (for analysis) were dissolved in 250 cc of water and analyzed quantitatively as  $As_2S_3$ . The first two solutions were acidified with 25 cc of concentrated HCl before saturating with hydrogen

<sup>1</sup> Cf. however, Semler: *Kolloid-Z.*, 34, 209 (1924).

sulfide while the third and fourth solutions were converted into the orange sol by saturating with hydrogen sulfide and subsequently coagulating with 25 cc of concentrated HCl. The samples were transferred to Gooch crucibles, washed and dried to constant weight at 100°. The results are given in Table V. Since the observed values approach the theoretical value for  $As_2S_3$  irrespective of whether the precipitate is yellow or red, there is little doubt but that the composition of the two is the same.

TABLE V  
Analysis of  $As_2O_3$

Sample of $As_2O_3$ in 250 cc gram	Method of Precipitation	$As_2S_3$		Color of precipitate
		formed	calculated	
0.2000	HCl added, then precipitated with $H_2S$	0.2493	0.2487	Yellow
0.2000	HCl added, then precipitated with $H_2S$	0.2492		Yellow
0.2000	$H_2S$ added, then coagulated with HCl	0.2488		Red
0.2000	$H_2S$ added, then coagulated with HCl	0.2492		Red

The sample of sulfide analyzed by Bhatnagar and Rao was obtained in a special way and it seemed advisable to repeat their method of preparation exactly. Accordingly 2.25 grams of pure  $As_2O_3$  were dissolved in 1.5 liters of boiling water, the flask stoppered and the solution allowed to cool to room temperature. This was treated in the dark with hydrogen sulfide in slight excess, after which the hydrogen sulfide was washed out with a current of hydrogen. After 2.5 days, a strip of filter paper moistened with lead acetate was not darkened by 2 minutes' contact with the hydrogen which bubbled through the sol. After filtering rapidly, the sol was coagulated with sodium chloride, the precipitate washed thoroughly, dried in a vacuum desiccator and subsequently in the oven at exactly 100°. All operations were carried out in the dark. The red sulfide was analyzed for arsenic and sulfur in the following way: The samples were weighed in  $5 \times 0.8$  cm test-tubes and dropped into a 250 cc glass-stoppered Erlenmeyer flask containing 5 cc of fuming nitric acid which was cooled to approximately 10°. After inserting the stopper firmly, the acid was brought into contact with the sulfide very slowly so that but little heat or pressure was developed in the flask. After the initial action was complete, the cooled flask was allowed to stand over night at the temperature of the room to oxidize the sulfur completely. The flask was then opened and the contents evaporated on the water bath with concentrated hydrochloric acid two or three times, to remove the nitric acid. Analyses were made on separate samples for arsenic as  $Mg_2As_2O_7$  and for sulfate as  $BaSO_4$  exactly in accord with the procedures outlined by Treadwell-Hall.<sup>1</sup> The precipitate of magnesium ammonium arsenate was ignited slowly in a Rose crucible in a current of oxygen. The results of the analyses are given in Table VI. These analyses leave no room for doubt that the red sulfide is  $As_2S_3$  and not  $As_2S_2$  as claimed by Bhatnagar and Rao. It will be seen that two of the analyses for arsenic average 0.14 percent high while the analyses

<sup>1</sup>"Analytical Chemistry," 2, 200, 403 (1924).

TABLE VI  
Analyses of Red  $\text{As}_2\text{S}_3$

$\text{As}_2\text{S}_3$ taken	$\text{Mg}_3\text{As}_2\text{O}_7$ formed	As percent	As in $\text{As}_2\text{S}_3$ percent
0.2500	0.3144	60.70	60.90
0.2500	0.3163	61.07	
0.2500	0.3160	61.01	
	$\text{BaSO}_4$ formed	S percent	As in $\text{As}_2\text{S}_3$ percent
0.1500	0.4255	38.93	39.10
0.1500	0.4248	38.90	
0.1500	0.4260	39.01	

for sulfur average 0.16 percent low. This variation is in the direction that one might expect since  $\text{As}_2\text{S}_3$  is hydrolyzed slightly by water into  $\text{As}_2\text{O}_3$  and  $\text{H}_2\text{S}$ <sup>1</sup>. If the washing with hydrogen is too prolonged some of the hydrogen sulfide from this hydrolysis is washed out and the results for sulfur will be low. When the sulfide is coagulated it adsorbs the  $\text{As}_2\text{O}_3$  from solution and the arsenic content will be a little high. Bhatnagar and Rao's value of 70.10 per cent for arsenic and of 29.90 percent for sulfur, which are almost exactly the values for  $\text{As}_2\text{S}_3$ , must have resulted from some large experimental error.

#### Explanation of the Variation in Color of Precipitated $\text{As}_2\text{S}_3$ .

The observations reported above show that arsenic sulfide varies in color continuously from yellow through orange yellow, orange, red orange, to red depending on the conditions of precipitation. The lighter shades are obtained by conducting hydrogen sulfide into a solution of arsenious acid or an arsenite containing sufficient acid or other electrolyte to cause immediate precipitation as rapidly as formed. The darker shades result when the trivalent arsenic is first converted into arsenic trisulfide sol and subsequently coagulated by the addition of electrolyte in excess of the precipitation value. The two extremes of color, yellow and red, are readily obtained with hydrochloric acid as the foreign electrolyte. The voluminous precipitates obtained by both procedures are yellow but it was noted that the precipitate from the sol was more gelatinous and more orange in color than that thrown down stepwise from solution. The more gelatinous precipitate dried to a red horny mass or glass which in some cases was quite transparent while the more flocculent mass dried to an opaque yellow impalpable powder. Figs. 1 and 2 are photomicrographs of the yellow and red sulfides, respectively, magnified 150 times. Note the powdery amorphous character of the clumps in the yellow sulfide and the glassy character of the red sulfide. The particles of the latter might at first glance be mistaken for crystals but their form is purely accidental like fragments of broken glass. The samples have not been examined with the X-rays but Haber<sup>2</sup> failed to observe any interference rings in X-radiograms of either fresh or aged arsenic trisulfide prepared by precipitation.

<sup>1</sup> Ward: American Chemist, 4, 10 (1873); Linder and Picton: J. Chem. Soc., 61, 114 (1892); Schmidt: Archiv Pharm., 255, 43 (1917).

<sup>2</sup> Ber., 55B, 1717 (1922).



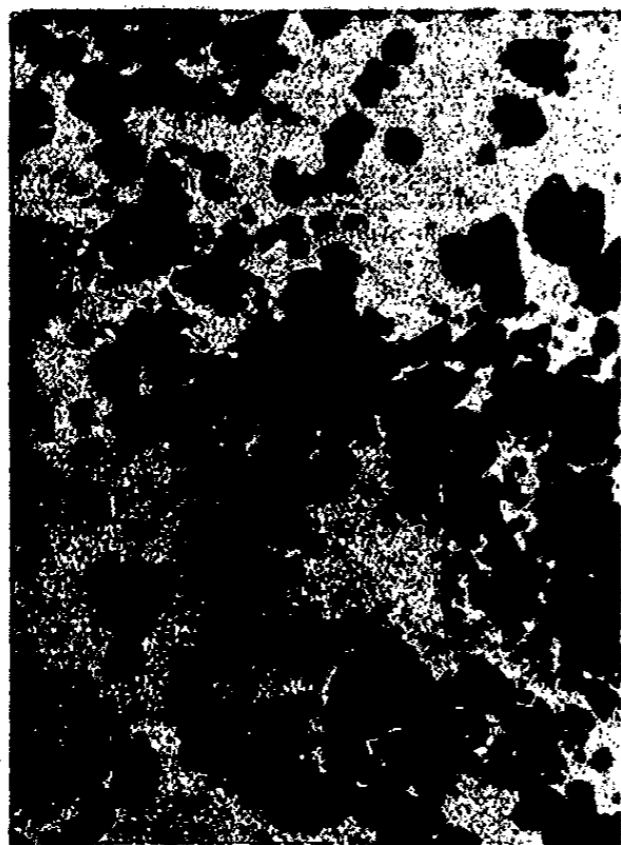

FIG. 1  
Dry  $As_2S_3$  precipitated from HCl solution  
with  $H_2S$  ( $\times 150$ ).

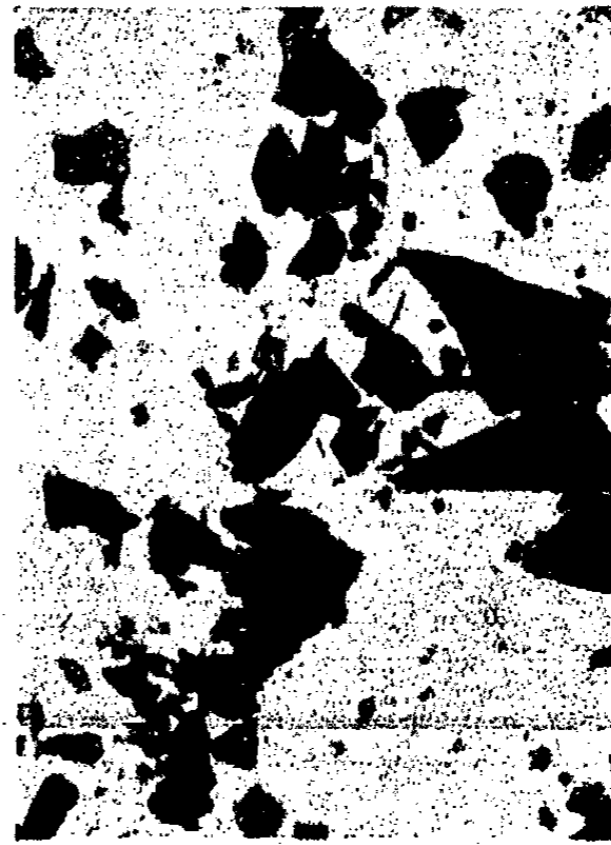

FIG. 2  
Dry  $As_2S_3$  precipitated from sol with  
 $H_2S$  ( $\times 150$ )



FIG. 3  
 $As_2S_3$  freshly precipitated from HCl  
solution with  $H_2S$  ( $\times 150$ )

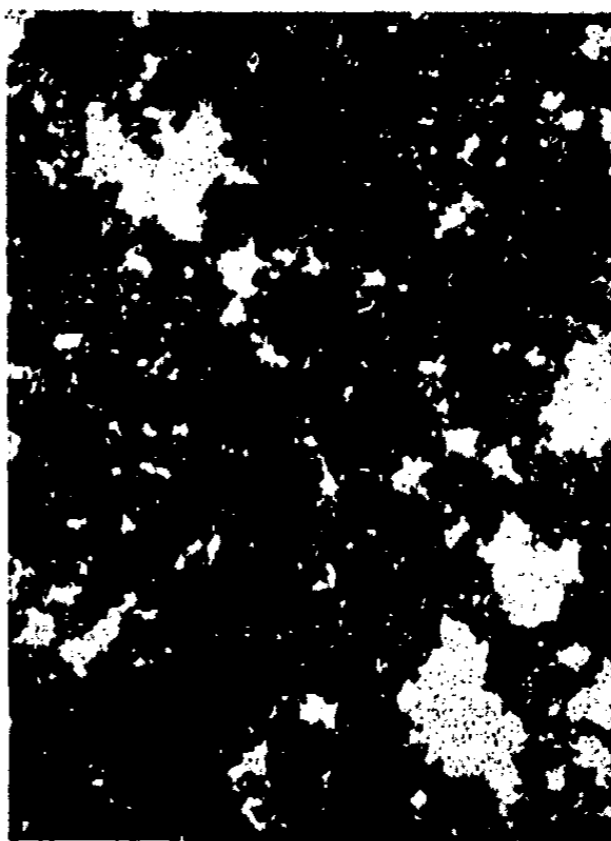

FIG. 4  
Same sample as Fig. 3 after drying  
( $\times 150$ ).

The difference in physical character of the two types of precipitates is further shown by the photomicrographs of the freshly formed sulfide suspended in water. Fig. 3 is from a sample of the flocculent preparation which yields a yellow powder on drying and Fig. 5 is from a sample of the more gelatinous preparation which yields a red glassy mass on drying. Figs. 4 and 6 are photomicrographs of the identical samples after they were allowed to dry over night without disturbing the slide. Note that water evaporates from the flocculent sulfide (Figs. 2 and 4) without greatly disturbing either the granules or loose clumps, while the gelatinous clumps synerize, the ultramicroscopic particles coalescing to give a glassy mass (Figs. 5 and 6). This



FIG. 5  
As<sub>2</sub>S<sub>3</sub> freshly precipitated from sol with  
HCl (× 150).



FIG. 6  
Same sample as Fig. 5 after drying  
(× 150).

is shown more strikingly with a somewhat denser gelatinous clump which was allowed to dry on the microscope slide, Fig. 7.

The marked difference in the physical character of the yellow and red preparations is probably the underlying cause of the variation in color. This difference in physical character of the precipitates is readily accounted for. When hydrogen sulfide is conducted into the hydrochloric acid solution of arsenious oxide, the trisulfide is thrown down in the form of small amorphous particles discrete or collected together in loose clumps which disintegrate on drying, giving an impalpable powder. On the other hand, when the gas is conducted into an arsenious oxide solution free from foreign electrolytes, the sulfide is thrown out as highly hydrous ultramicroscopic particles. The sol formed in this way is yellow-orange to red-orange in color by transmitted light depending on the concentration and the depth of the layer observed. As<sup>3</sup> has been emphasized,<sup>1</sup> the rapid coagulation of a hydrous sol favors the formation

<sup>1</sup> Weiser: "The Hydrous Oxides," 12-30 (1926); J. Phys. Chem., 26, 402 (1922); Weiser and Bloxson: 28, 26 (1924).

of a gelatinous precipitate or jelly in which the neutralized particles become stuck together or oriented into aggregates forming an enmeshing network which entrains liquid. This is what happens when hydrochloric acid or other electrolyte is added to arsenic trisulfide sol in excess of the precipitation concentration. The gelatinous clumps formed in this way do not disintegrate on drying but the minute particles coalesce to a glassy mass. It is of interest to note that the color of a transparent particle of the dry sulfide formed from the sol is similar to the color of a thick layer of the relatively concentrated sol viewed by transmitted light.

It will be recalled that a yellow sulfide results when hydrogen sulfide is conducted into an acid solution of arsenic trioxide while orange-yellow products are obtained in the presence of neutral electrolytes. It would appear that the slight variation in color in this case likewise results from a difference in the physical character of the precipitates. Hydrochloric acid has a slight solvent action on  $As_2S_3$  and one would expect the precipitate thrown out from acid solution to be somewhat less gelatinous and hence to dry to a lighter shade than one thrown down in the presence of a neutral salt. Similarly, the precipitate obtained by freezing the sol is less gelatinous and of a lighter shade than that resulting from rapid coagulation of the sol.

If the arsenic trisulfide is yellow when in the form of an impalpable powder and red in the form of a horny or glassy mass resulting from the coalescence of ultramicros, it would follow that sufficient grinding of the red mass should yield a yellow powder. This was confirmed experimentally.

Arsenic trisulfide is very slightly volatile even at room temperature<sup>1</sup> and the salt must not be heated above  $105^\circ$  in the analysis of arsenic as trisulfide or low results will be obtained. Heating the red sulfide somewhat below the sintering temperature disintegrates the glassy mass which gradually assumes a yellow color. Winter observed this change at  $160^\circ$  but the disintegration takes place at a lower temperature if sufficient time is allowed. After heating some transparent red granules over night at  $160^\circ$ , a fragment of the resulting yellow sample was crumbled with the fingers and photographed. The photomicrograph was so similar to Fig. 1 that there was no point in reproducing it here.

<sup>1</sup> Zenghelis: Z. physik. Chem., 50, 219 (1904).

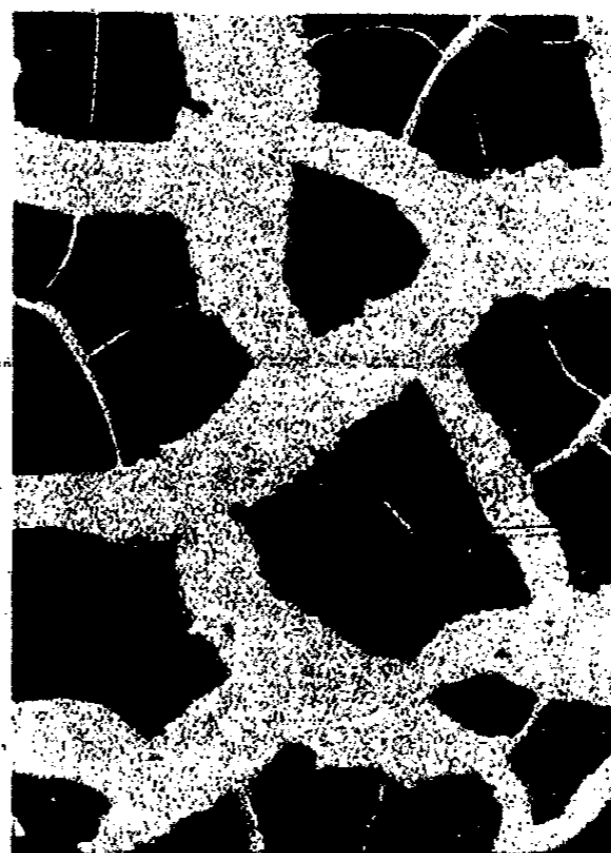

FIG. 7  
Sample of  $As_2S_3$  after drying on slide ( $\times 150$ ). The gelatinous clump was somewhat thicker than that shown in Fig. 5.

Heating the yellow sulfide to  $175^{\circ}$  and above causes it to sinter, contract and become orange to dark brown in color depending upon the temperature and the duration of the heating. This change in color is probably not due to an allotropic change as suggested by Borodowsky.<sup>1</sup> After the yellow powdery sulfide has been darkened and rendered granular by sintering it does not return to the yellow color on standing for a long period at room temperature.

The combined action of light and moisture causes a superficial chemical disintegration of the red sulfide coating it with a yellow film of sulfide and sulfur.

#### Summary

The following is a brief summary of the results of this investigation.

1. Precipitated and dried arsenic trisulfide varies in color continuously from yellow through orange-yellow, orange, red-orange; to red depending on the conditions of precipitation. The lighter shades result by conducting hydrogen sulfide into a solution of arsenious oxide or an arsenite containing sufficient acid or other electrolyte to cause immediate precipitation as rapidly as formed. The darker shades result when the trivalent arsenic is first converted into arsenic trisulfide sol and subsequently coagulated by the addition of electrolyte in excess of the precipitation value.

2. The red color of the sulfide is not due to an allotropic change in the yellow sulfide (Winter); to the presence of a red sulfarsenite (Semler); or to  $As_2S_3$  (Bhatnagar and Rao).

3. The variation in color is due to variation in the physical character of the precipitated salt. Direct precipitation from solution containing foreign electrolyte gives a flocculent precipitate consisting of relatively large particles discrete or collected together into loose clumps which disintegrate on drying giving an impalpable yellow to orange-yellow powder. On the other hand, coagulation of sol gives a more gelatinous precipitate consisting of clumps of ultramicroscopic particles which coalesce on drying to give a red glassy mass.

• The differences in physical structure are shown by photomicrographs.

4. The red sulfide is rendered yellow on disintegrating the glassy mass by heating below the sintering temperature or by grinding. Heating the yellow sulfide in the neighborhood of  $175^{\circ}$  causes it to sinter, contract, and assume a permanent orange to brown color depending on the temperature and the duration of the heating.

5. The red sulfide is stable in the dark and is not affected by light when thoroughly dry. The combined action of light and moisture causes a superficial chemical disintegration of the red sulfide coating it with a yellow film of sulfide and sulfur. This photochemical action is similar to that on arsenic trisulfide sols. (Freundlich and Nathansohn).

*The Rice Institute,  
Houston, Texas.*

<sup>1</sup> Chem., Zentr., (1906), II, 297.

COMPARATIVE MEASUREMENTS OF THE SURFACE CONDUCTIVITY OF SOLUTIONS OF VARIOUS ELECTROLYTES AT A BOUNDARY OF PYREX

BY JAMES W. MCBAIN AND CHARLES R. PEAKER

In a previous communication,<sup>1</sup> the existence of "surface conductivity" near the boundary of optically polished glass and solutions of potassium chloride was clearly demonstrated, and measurements of the absolute value of the "surface conductivity" obtained. However, the method previously described was not suitable for rapid comparative measurements of solutions of various electrolytes, and for this reason we decided to use a cell of somewhat different design.

In this cell the capillary spaces were provided by using a number of concentric Pyrex tubes which telescoped into one another. The use of tubes (instead of parallel plates, for example) is advantageous in that even though the tubes touch, they can only touch along a line, or if not parallel, at a point; moreover, the annular cross section remains the same whatever the position of the tubes.

The cell is shown diagrammatically in Fig. 1. The two half-cells A and B were joined by a butt joint with two ground-glass flanges as in a Guye joint. In order to line up the tubes after they had been placed in the cell, a side tube C was provided, containing a glass rod D which fitted quite snugly. The tubes E were lined up by tilting the cell and shaking it until all the tubes touched the rod. The cell was then returned to the horizontal position, and the rod was drawn up until the end was flush with the inner wall of the main cell.

Dimensions of the Glass Tubes

The lengths of the tubes were determined by means of a Gaertner travelling microscope, reading to 0.001 cm. Four measurements were taken at intervals around the circumference of each tube, and all these measurements averaged to give a final value which was taken as the length of all the tubes. The length, determined in this way, was 2.937 cm., with an average deviation from the mean of only 0.013 cm.

The diameters of the tubes were determined with a Wilson travelling microscope, reading to 0.01 mm. This instrument could be operated so as to obtain a horizontal and a vertical value for the diameter; this was done at both ends of the tube and the four results averaged to give the diameter of each tube. Both inner and outer diameters were measured in this way. The average diameter of the main cell, determined with the Wilson microscope, was 1.272 cm.

<sup>1</sup> J. W. McBain, C. R. Peaker and A. M. King: *J. Am. Chem. Soc.*, 51, 3294 (1929); see also J. W. McBain and C. R. Peaker: *Proc. Roy. Soc.*, 125A, 394 (1929).

The cross-sectional area of the tubes was determined in two ways: (1) using the density of the glass (found to be 2.230 gm./cc.), the mass of the tubes (6.212 gm.), and the length of the tubes, the cross-sectional area is 0.949 sq. cm.; (2) using the external and internal diameters of the tubes as determined microscopically, the cross-sectional area of the tubes is found to be 0.976 sq. cm. The difference between these two results is about three per cent; the first method was considered to give more nearly the correct result; so the value of 0.949 sq. cm. will be used in calculations for the cross-sectional area of the tubes.

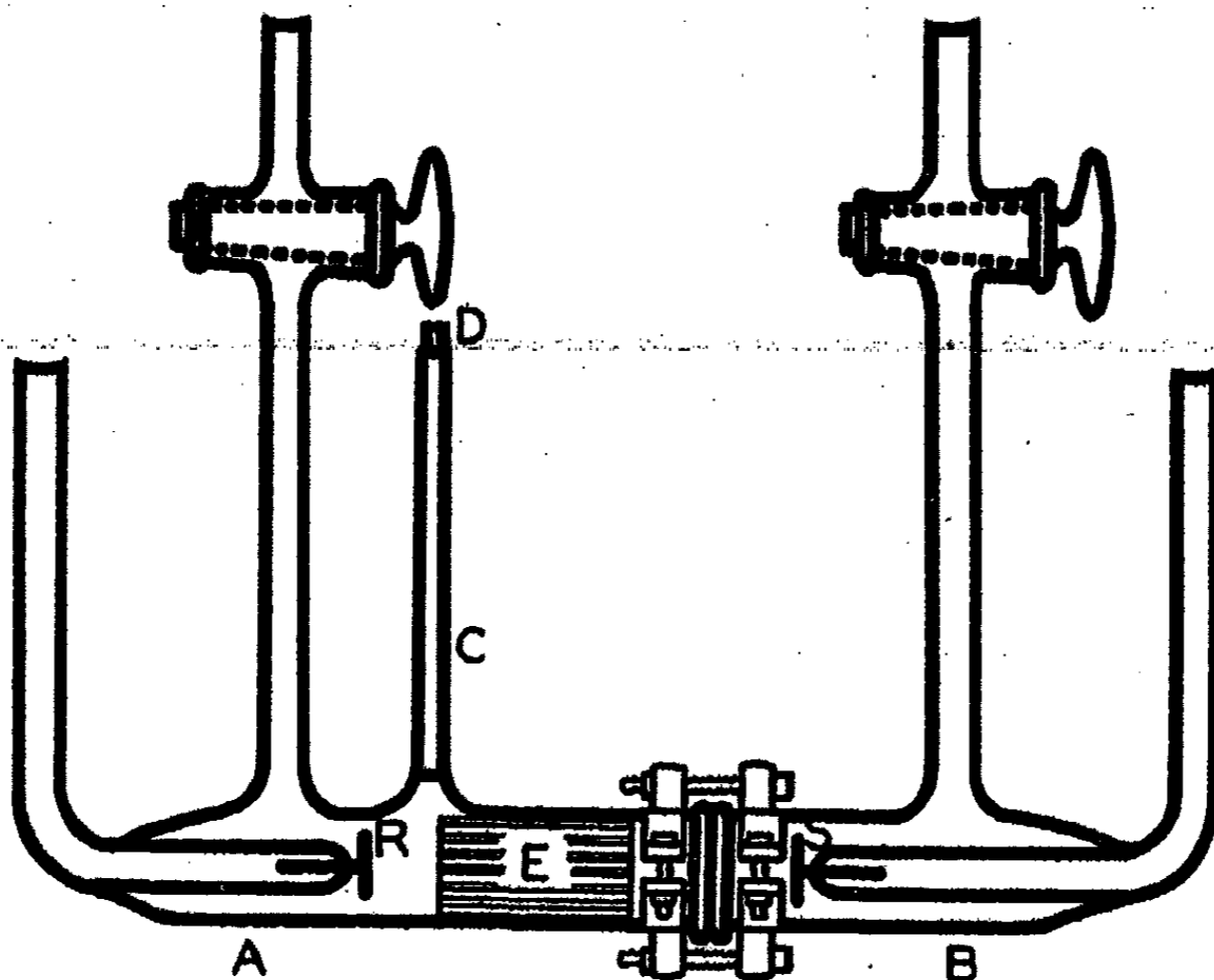

FIG. 1  
The Conductivity Cell

The cross-sectional area of the main cell is 1.271 sq. cm., and therefore the total cross-sectional area of the solution between the tubes is 0.322 sq. cm. From the diameters of the tubes and the length, the total surface area of the tubes was calculated to be 88.19 sq. cm.; hence the surface area per cubic centimeter will be  $88.19/0.322 \times 2.937$  or 93.3 sq. cm.<sup>1</sup>

#### Preparation of Solutions

The conductivity water used for making up the solutions had a conductivity of  $0.70 - 1.0 \times 10^{-6}$  mhos at 25°C. The potassium chloride used was Kahlbaum's "for analysis, with guarantee." Solutions were made up by

<sup>1</sup> It must be noted that these tubes were chosen from stock pieces, and no attempt was made to polish them. Hence absolute values calculated from the dimensions need not necessarily agree closely with those already given for optically polished surfaces. One would expect them to be somewhat higher. But the relative values for various electrolytes, determined with the same set of tubes, should be correct. By making use of the data which have been obtained for potassium chloride with optically polished surfaces and with the tubes, all the values for other electrolytes, obtained with the tubes, can be put on an absolute basis.

weight as previously described.<sup>1</sup> The sample of barium chloride used was prepared from Kahlbaum's material. It was recrystallized once from conductivity water, then dried and ignited to constant weight over a Bunsen flame. The material was assumed to be anhydrous barium chloride, and solutions were then made up by weight. The sample of aluminium chloride used was Baker's analyzed. The composition of this material was taken to be  $\text{AlCl}_3 \cdot 6\text{H}_2\text{O}$ . The potassium sulfate used was Kahlbaum's "for analysis, with guarantee." Its composition was taken as  $\text{K}_2\text{SO}_4$ . The potassium ferrocyanide was also Kahlbaum's "for analysis, with guarantee," and its composition was considered to be  $\text{K}_4\text{Fe}(\text{CN})_6 \cdot 3\text{H}_2\text{O}$ . Solutions of these materials were made up by the weight method. In the tables of data which follow, all concentrations are expressed as normalities at  $18^\circ\text{C}$ .

### Experimental

The conductivity measuring apparatus has been described in a previous communication.<sup>1</sup> Before beginning measurements with this cell, the electrodes R and S were well platinised, and the cell and tubes were thoroughly cleaned according to the procedure previously described. The apparatus was then assembled. The tubes were first placed separately in conductivity water and all air bubbles removed. Then they were assembled under water and placed in the cell. The assembled cell was rinsed out with distilled alcohol, distilled ether, distilled alcohol, conductivity water, and finally several times with the most dilute solution to be measured. After filling the cell with this solution, the tubes were aligned and the cell placed in a thermostat (containing distilled water) which was maintained at  $25 \pm 0.01^\circ\text{C}$ . Measurements were taken at intervals until the resistance was constant over a considerable period of time. The cell was then taken out of the thermostat, tilted so that the tubes moved back and forth over one another, thus agitating the solution in the cell; then, after lining up the tubes again, the cell was replaced in the thermostat, and measurements of the resistance were continued. This procedure was repeated until comparable sets of resistances were obtained. The cell was then rinsed out several times with fresh solution and refilled. When experiments on one concentration were finished, the cell was thoroughly rinsed out with the next most concentrated solution and refilled.

### Experimental Data

The following tables record the data obtained for the various electrolytes used. The first column of the tables gives the concentration of the solution used in volume normality at  $18^\circ\text{C}$ .; the second and third, the measured resistance of the cell in ohms; the fourth and fifth, the resistance of the cell, corrected for the conductivity of the water and also corrected to round concentrations.

<sup>1</sup> J. W. McBain, C. R. Peaker and A. M. King: loc. cit.

TABLE I

Total Resistance of Potassium Chloride Solutions in Main Cell with and without the Tubes at 25.00°C.

Concentration. Volume Normality at 18°C.	Measured Resistance, Ohms		Corrected Mean Resistance, Ohms	
	With	Without	With	Without
0.001000	71,602	30,398		
	72,440	30,852*		
	74,351	30,728 <sup>1</sup>		
		30,286*	72,954	30,776
0.01000	7,984.0	3,329.1		
	7,984.0	3,333.1		
0.9986	102.39	42.400	7,989.2	3,333.8
	101.86	42.348		
			101.99	42.315

\* For a 0.001002 N solution.

TABLE II

Total Resistances of Barium Chloride Solutions in Main Cell with and without the Tubes at 25.00°C

Concentration. Volume Normality at 18°C.	Measured Resistance, Ohms		Corrected Mean Resistance, Ohms	
	With	Without	With	Without
0.001014	79,095	33,305		
	80,018	31,909		
	80,338	33,172		
			81,762	33,740
0.01016	9,108.6	3,750.6		
	8,978.4	3,753.7		
	9,010.8			
		9,144.0	3,814.4	
0.9511	147.84	61.236		
	146.27	61.409		
	147.32			
		139.95	58.324	

TABLE III

Total Resistances of Potassium Sulfate Solutions in Main Cell with and without the Tubes at 25.00-25.01°C

Concentration. Volume Normality at 18°C.	Measured Resistance, Ohms		Corrected Mean Resistance, Ohms	
	With	Without	With	Without
0.000984	74,113	31,602		
	74,173	31,425		
		31,362		
			73,412	31,160
0.008591	9,630.9	4,053.2		
	9,638.5	4,064.5		
1.0494	132.99	55.580	8,283.6	3,489.8
	132.68	55.625		
			139.40	58.349



TABLE IV  
Total Resistances of Potassium Ferrocyanide Solutions in Main Cell  
with and without the Tubes at 25.01-25.02°C

Concentration. Volume Normality at 18°C.	Measured Resistance, Ohms		Corrected Mean Resistance, Ohms	
	With	Without	With	Without
0.001008	63,686	26,785		
	63,967	26,903		
	63,533			
	64,172		64,819	27,256
0.009842	8,266.6	3,473.5		
	8,253.6	3,472.2	8,137.2	3,421.2
1.0247	145.28	60.820		
	144.98	60.799	148.71	62.311

TABLE V  
Total Resistances of Aluminium Chloride Solutions in Main Cell with and  
without the Tubes at 25.01-25.02°C

Concentration. Volume Normality at 18°C.	Measured Resistance, Ohms		Corrected Mean Resistance, Ohms†	
	With	Without	With	Without
0.00105	84,413	35,579*		
	85,136	35,479*		
	84,560		88,938	36,844
0.010002	10,568	4,250.7**		
		4,240.5**	10,570	4,521.6
1.0446	181.38	76.059		
	181.38	76.059	189.47	79.452

† In calculating the data for these two columns, no correction was made for the conductivity of the solvent, since the hydrochloric acid formed by hydrolysis of the salt would presumably repress the ionization of carbonic acid. It was shown, however, that the final result for the surface conductivity was not changed appreciably by applying a correction for the conductivity of the solvent to the above results.

\* For a 0.001037 N solution.

\*\* For a 0.01065 N solution.

#### Time Effect

The time effect observed with the tubes was similar to that found with the slits,<sup>1</sup> though, of course, not so marked, since the relative change in conductivity was much smaller.

#### Specific Conductivities of the Solutions in Bulk

The specific conductivities of the potassium chloride solutions used were obtained from the best data available in the literature. Using these values and the measured resistances of the potassium chloride solutions in the main cell alone, the cell constants for each concentration were calculated. These cell constants were then used for the calculation of the specific conductivities of the other electrolytes used.

<sup>1</sup> J. W. McBain, C. R. Peaker and A. M. King: loc. cit.

TABLE VI  
Specific Conductivities of Solutions in Bulk at 25°C

Concentration. Normality at 18°C.	Specific Conductivities at 25°C.				
	KCl	BaCl <sub>2</sub>	K <sub>2</sub> SO <sub>4</sub>	K <sub>4</sub> Fe(CN) <sub>6</sub>	AlCl <sub>3</sub>
0.001	0.0001466*	0.0001337	0.0001448	0.0001655	0.0001224
0.01	0.0014104**	0.001233	0.001347	0.001374	0.001040
1.0	0.11169**	0.0810	0.0810	0.0758 <sub>5</sub>	0.0594 <sub>9</sub>

\* Kohlrausch.

\*\* Parker and Parker.

#### Calculation of Results

In order to decide whether or not there is enhanced conductivity in the capillary spaces between the tubes, it is necessary to compare the resistances of the solutions in the tubes, as calculated from the dimensions and the specific conductivities, with the measured resistances. In calculating the

TABLE VII

Percent Increase in Specific Conductivity of Solutions of Electrolytes in Pyrex Tubes and the Specific Surface Conductivity deduced

Concentration	Total Resistance	"Effective Resistance"	Resistance in Tubes (observed)	Resistance in Tubes (calculated)	Percent Increase	Specific Surface Conductivity (mhos/sq. cm. × 10 <sup>9</sup> )
KCl						
1.0 N	101.99	20.33	81.66	81.66	—	
0.01 N	7,989.2	1,609.9	6,379.3	6,467.0	1.37	20.7
0.001 N	72,954	15,489	57,465	62,217	8.27	13.0
BaCl <sub>2</sub>						
1.0 N	139.95	27.29	112.65	112.64	—	
0.01 N	9,144.0	1,792.8	7,351.4	7,397.4	0.63	8.32
0.001 N	81,762	16,533	65,229	68,220	4.69	6.58
K <sub>2</sub> SO <sub>4</sub>						
1.0 N	139.40	26.80	112.60	112.60	—	
0.01 N	8,283.6	1,611.9	6,671.7	6,771.3	1.49	21.5
0.001 N	73,412	14,992	58,420	62,990	7.82	12.1
K <sub>4</sub> Fe(CN) <sub>6</sub>						
1.0 N	148.71	28.46	120.25	120.25	—	
0.01 N	8,137.2	1,571.1	6,566.1	6,638.2	1.10	16.2
0.001 N	64,819	13,043	51,776	55,111	6.44	11.4
AlCl <sub>3</sub>						
1.0 N	189.47	36.15	153.32	153.32	—	
0.01 N	10,570	2,067.9	8,502	8,770.2	3.16	35.2
0.001 N	88,938	17,814	71,124	78,030	7.40	9.70

resistances of the electrolytes used in the tubes from the experimental data, we decided to use the same method as was used in the case of the slits; that is, to estimate the "total effective resistance" of the main cell and apply this as a correction factor to the observed results, thus eliminating any "pinch effect" which may be present, although in a cell of this type, one would not expect the "pinch effect" to be a large factor.

The calculations are summarised in Table VII. It must be remembered that the figures in the last column (under "specific surface conductivity") are not considered to be the true values, since the surface in this case is not known nearly so accurately as in the case of the slits but must be multiplied by a factor to obtain the true values. However, they may be used directly in comparing the various electrolytes used.

#### Discussion

The data presented in Table VII bear out the observations previously made with optically polished surfaces. The conductivity of solutions of various electrolytes is greater in capillaries than in bulk, and the relative increase in conductivity is greater, the more dilute the solution. Furthermore, just as we found for the slits, the specific surface conductivity decreases as the concentration decreases.

By comparing the values of the specific surface conductivity of potassium chloride given in this paper with the values in the previous communication giving the results for optically polished surfaces, it will be seen that the results obtained with the tubes are two and a quarter times higher. The explanation we offer for this discrepancy is that the surface of the tubes may be several times that calculated from the dimensions, since they were chosen from stock glass, and the surfaces received no treatment other than cleaning. Observation of the outer surfaces of the tubes shows that they are quite noticeably scored. Again, the extent of sorption may be somewhat dependent upon the kind of glass employed.

Considering the data for salts having the same cation in 0.001 N solution the surface conductivity is found to fall off in the order potassium chloride, potassium sulfate, potassium ferrocyanide. This is the order expected, since if the film adsorbed at the wall is just monomolecular (assuming anions chiefly adsorbed), the surface conductivity should depend on the area of the adsorbed anion and the degree of dissociation of the surface.

For salts having the same anion, the order in 0.001 N solution is potassium chloride, aluminium chloride, barium chloride. The apparently misplaced position of aluminium may be due to one of the following causes: (1) hydrolysis of aluminium chloride results in the formation of some hydrochloric acid in the solution, and the conducting ions of the double layer would then be  $Al^{+++}$  and  $H^+$ ; (2) there is the possibility that we are dealing, not only with the conductivity of the second layer of ions, but with that of a partial third layer as well. It is a well-known fact that small amounts of aluminium chloride reverse the charge of many diaphragms in aqueous solutions, as shown by electroösmosis experiments. In this case the conducting ions might

be  $\text{Al}^{+++}$ ,  $\text{H}^+$  and  $\text{Cl}^-$ . This latter hypothesis seems to be borne out by the high specific conductivity obtained in 0.01 N aluminium chloride solution. The surface conductivity of this solution is almost double that of 0.01 N potassium chloride; this would be of the order expected if we were dealing with the conductivity of the third layer (composed chiefly of  $\text{Cl}^-$ .)

If the surface conductivities given for the various salts studied are not influenced by some systematic error, absent with the slits, but are high only because of the irregularities of the Pyrex tubing, the values given in this paper may be converted to absolute values by making use of the data obtained for potassium chloride with both the slits and tubes. These values are given in the following table.

TABLE VIII

Salt	Relative Value of Surface Conductivity, mhos/sq. cm. $\times 10^8$		Absolute Value of Surface Conductivity, mhos/sq. cm. $\times 10^8$	
	0.01 N	0.001 N	0.01 N	0.001 N
KCl	20.7	13.0	9.3	4.3
$\text{K}_2\text{SO}_4$	21.5	12.1	9.5	4.0
$\text{K}_4\text{Fe}(\text{CN})_6$	16.2	11.4	7.3	3.8
$\text{BaCl}_2$	8.32	6.58	3.7	2.2
$\text{AlCl}_3$	35.2	9.70	15.8	3.2

#### Conclusion

The results presented in this paper bear out the conclusions previously stated, that surface conductivity exists and must be considered when dealing with equilibria in capillary spaces. While the values given here for the specific surface conductivity of potassium chloride are higher than those previously obtained with optically polished surfaces, they can be brought into agreement by making the not unreasonable assumption that the actual surface area of ordinary Pyrex tubing is two and a quarter times greater than that determined by macroscopic measurements.

*Department of Chemistry,  
Stanford University,  
California.*

## THE DISPERSION OF CELLULOSE AND CELLULOSE DERIVATIVES\*

BY S. E. SHEPPARD

Cellulose itself is insoluble in water and in organic liquids, but a number of aqueous solutions are known which can peptize cellulose to a sol. Such are Schweitzer's reagent—a solution of cupric hydroxide in aqueous ammonia,—concentrated zinc chloride solution, and certain other concentrated salt solutions at sufficiently high temperatures. It was shown first by P. von Weimarn<sup>1</sup> that a number of hygroscopic salts, such as lithium chloride, calcium bromide, calcium and manganese thiocyanates, at certain conditions of concentration and temperature could peptize cellulose to a sol, from which a more or less hydrous cellulose separated on cooling, diluting, or adding a coagulating agent. With certain salts, *viz.*, NaI, SrI<sub>2</sub>, CaI<sub>2</sub>, CaBr<sub>2</sub>, Ca(CNS)<sub>2</sub>, Sr(CNS)<sub>2</sub>, Ba(CNS)<sub>2</sub>, the process can be carried out at atmospheric pressure, but with others, *e.g.*, NaCl, KCl, BaCl<sub>2</sub>, autoclave conditions are necessary. Thus with concentrated NaCl solution, peptization of cellulose begins at 70° under 8 atmospheres, while with LiNO<sub>3</sub>, NaI, CaI<sub>2</sub>, SrI<sub>2</sub>, Ca(CNS)<sub>2</sub>, Ba(CNS)<sub>2</sub>, Mn(CNS)<sub>2</sub>, Sr(CNS)<sub>2</sub> in saturated solution at the boiling point, peptization proceeds under atmospheric pressure.

With many salts which peptize cellulose only on prolonged heating, decomposition of the cellulose (hydrolytic degradation, oxidation) occurs, giving bodies of lower molecular weight. (It is true that one does not know the molecular weight of cellulose, nor whether the expression means anything, but it is customary to speak of certain more dextrin-like products from cellulose,<sup>2</sup> having very high copper numbers, solubility in caustic solutions, as having lower molecular weight than cellulose.)

Von Weimarn also<sup>3</sup> found that cellulose swollen by previous soaking in the concentrated salt solution in the cold peptized more rapidly on heating the solution than the unswollen cellulose. This behavior indicates resemblance to the peptization of gelatin in water, and of certain other proteins in salt solutions, and will be referred to again.

The peptization of cellulose by saline solutions was investigated rather fully by H. E. Williams,<sup>4</sup> apparently in ignorance of von Weimarn's prior work. Williams found, with the thiocyanates, that none of them peptized cellulose till the solution attained a temperature of 133°C., or higher. That is to say, a *concentration* corresponding to a certain vapor pressure reduction was necessary. This worker obtained certain empirical relations between the peptizing power, the viscosity, the boiling point, and the heat of solution—results which indeed indicate that the peptizing power is directly related to the thermodynamic activity of the electrolyte. A very interesting fact, first discovered apparently by Williams, is that a concentrated solution of

\* Communication No. 401 from the Kodak Research Laboratories.

$\text{Ca}(\text{CNS})_2$ , which peptized cellulose, would also peptize the hydrous oxides of Ca, Pb, Zn, Cd, Co, Ni, Fe, and Sn—termed by Williams the hydroxides. It may be noted that in this Laboratory very concentrated solutions of  $\text{CaCl}_2$  were found to peptize ferric oxide to a sol passing through filter paper, and stable at the boiling point.

Williams proposed an explanation of the peptization as follows: "The hydroxyl groups of the cellulose unit link up with the salt complex in place of the water molecules, thus causing the fiber to swell considerably. The cellulose unit (? molecule) is brought by this means into molecular range with the water molecules combined with the salt. By raising the temperature, the union between the salt and water molecules will weaken and tend to part from the parent molecule. The water thus freed migrates to the cellulose by which it is imbibed, causing further swelling of the fiber, which increases as the progressive hydration proceeds. The highly swollen fiber in the gelatinous condition then peptizes, and passes into colloidal solution."

This explanation is by no means clear or sufficient. If there is *competition* for the salt molecules between the hydroxyls of the cellulose and the water molecules, it is not evident why the migration or transfer of water to the cellulose should take place. The dispersing action appears to be definitely connected with the strong polar field of the electrolyte solutions, and also with the lyotrope series. In some way this field decreases the association between the hydroxyls of the cellulose units, probably the primary valency chains of the micelles. It is true that Katz and Mark<sup>6</sup> (*vide infra*) were not able to find X-ray evidence for intra-crystallite swelling with the peptizing electrolytes, such as zinc chloride, and thiocyanates, as is observed in the mercerizing action of caustic alkali solutions. It is probable, therefore, that the initial mechanism of peptization by these electrolyte solutions (salts) differs somewhat from the swelling by caustic alkalies, and the peptization by cuprammonium solution. The nature of the regenerated cellulose from these sols requires further investigation, since we have observed in this Laboratory that cellulose regenerated from  $\text{Ca}(\text{CNS})_2$  solution gives a water adsorption value corresponding to that of "hydrate" cellulose prepared by mercerization and washing, or by regeneration from cuprammonium solution, from xanthate or acetate.<sup>6</sup> A further examination by X-rays of these regenerated celluloses is necessary, therefore, to ascertain whether, on solution, the "hydrate" cellulose is formed. The same examination is required of the celluloses regenerated from concentrated solutions of phosphoric and sulfuric acids. If cellulose is treated with an ice-cold seventy per cent solution of  $\text{H}_2\text{SO}_4$ , it dissolves to a clear, slightly yellowish solution.<sup>7</sup> It may be reprecipitated by dilution with cold water, and washed free from acid by water and alcohol. The alcohol dry material gives a milky dispersion on digestion with water. It is not known whether this cellulose corresponds to "hydrate" cellulose in its X-ray diagram and moisture adsorption, but these matters are under investigation.

It is known that the parchmentizing of cellulose with strong nitric acid (Knecht)<sup>8</sup> develops the "hydrate" cellulose form, so that it may be suspected

that these regenerated celluloses also contain "hydrate cellulose." The "solutions" in the concentrated aqueous acids certainly have strong affinities with those in the strong saline solutions, but, at the same time, a considerable amount of molecular degradation of cellulose to cellulose-dextrins and to sugars is taking place, the cellulose dextrins being present chiefly as dextrin esters.<sup>9</sup> It is very possible that these dextrins and dextrin esters play the part of "protective colloids" in regard to the residual peptized cellulose. The uncertain point at present is whether in these mineral acid solutions we have peptized "active cellulose," peptized "hydrocellulose," or peptized "hydrate cellulose," the relative stability being in any case effected by an external layer of dextrin acid ester molecules, the acid ester group homologating the particles to the solution, just as the stearate radicle of silver stearate homologates the surface of colloid silver to a hydrocarbon. A generalized statement of the facts discussed is presented in the following classification of cellulose sols and gels, based on the two fundamental forms of cellulose which seem to be established at present on the bases of X-ray spectroscopy and water adsorption.<sup>10</sup>

It will be seen from this that it is doubtful at the present time whether we have any examples of dispersions of cellulose to sols in which the cellulose is present in the "native" form, which, according to X-ray findings, corresponds to a slightly deformed, energy-richer lattice unit. Apart from the subsidiary uncertainty as to whether the saline dispersions contain cellulose in the "native" or the "hydrate" form, the most important question undecided at present is the following: Is the "hydrate" form of cellulose, understood to be a lattice modification, *i.e.*, a multi-molecular aggregate form, produced solely by a limited intra-crystallite swelling process? That is, do the swollen crystallites persist in all the types of these solutions, being merely reaggregated but in disoriented form, on evaporation or coagulation? Or is it possible that the dispersion may proceed still further, to the point of disaggregation of the swollen crystallites into molecular fibrils, so that the hydrate celluloses in the gel forms are produced by a process of recrystallization? It appears that R. Herzog<sup>11</sup> and H. Mark<sup>12</sup> endorse the former conception, although Herzog admits the possibility of some degree of recrystallization from solutions.

There exists, however, certain evidence for the alternative conception, which implies that "macromolecular" colloids in general, and the cellulose family in particular, can be dispersed to states equivalent to "true solution."

It is indeed evident that the peptization or dispersion of such bodies in solvating, *i.e.*, hydrating, solvents might proceed to disruption of the crystallites, by sufficient reduction of the intermolecular association. In the case of cellulose and its derivatives, this would produce molecular, or near-molecular dispersions of the primary valence chains constituting the crystallite. It is not probable that in such dispersions the solute units would reach quite the degree of kinetic independence characterizing solutions of low molecular substances. It is much more probable that such macromolecules, particularly of the cellulose family, exercise an important degree of mutual attraction

TABLE I

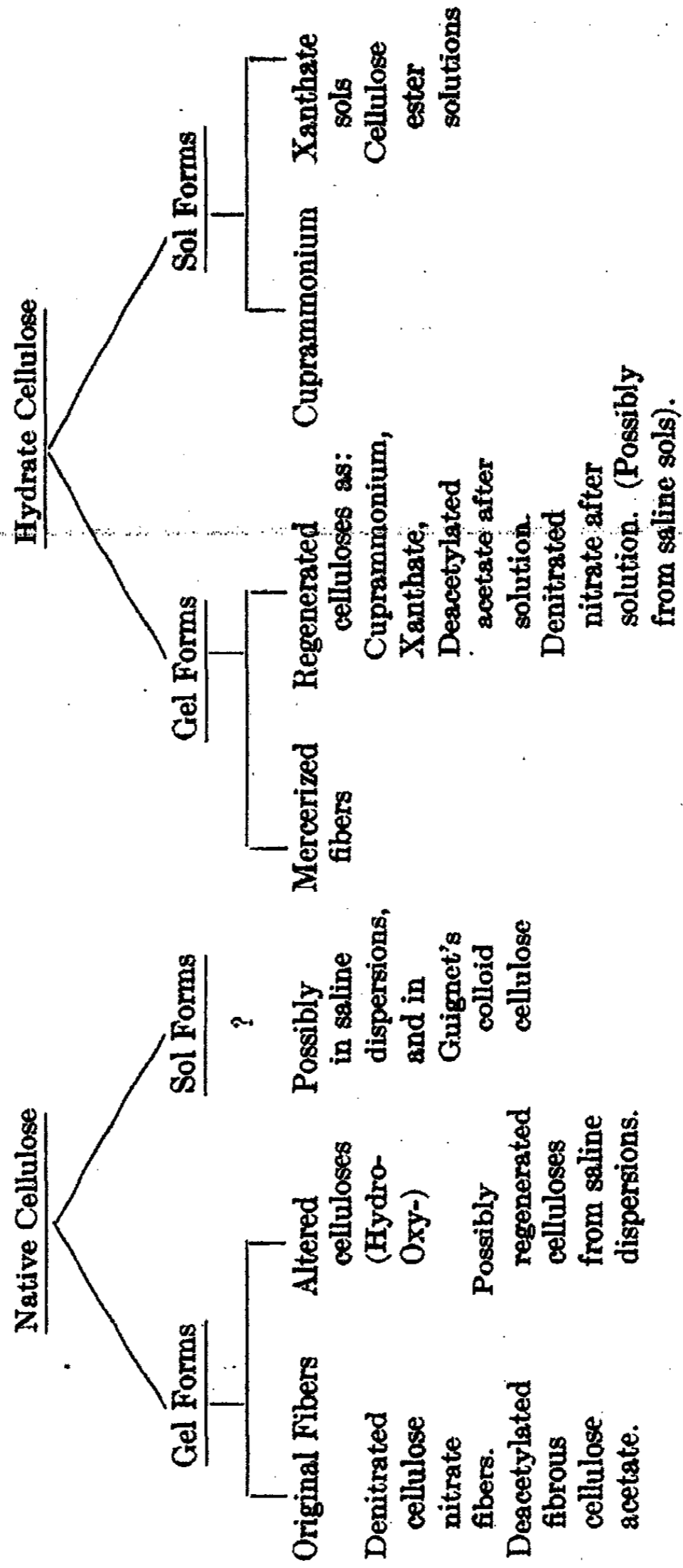



in solution. This could give rise to swarms of long solvated molecules having more or less parallel orientation in the swarms, the latter having, therefore, a greater degree of kinetic independence than the constituent molecules. The following diagram will make this clearer.\*

In state A, the crystallites pass by intra-crystallite solvation to the "hydrate" cellulose form, but retain a three dimensional ordering of the primary valence units. It is assumed that at a certain stage of solvation they pass over into state B, in which primary units of nearly the same length still have parallel orientation, but freedom to roll within the swarm, which is easily deformable in one dimension. In state C, a residual degree of local parallel ordering remains between primary units of any unequal lengths, it

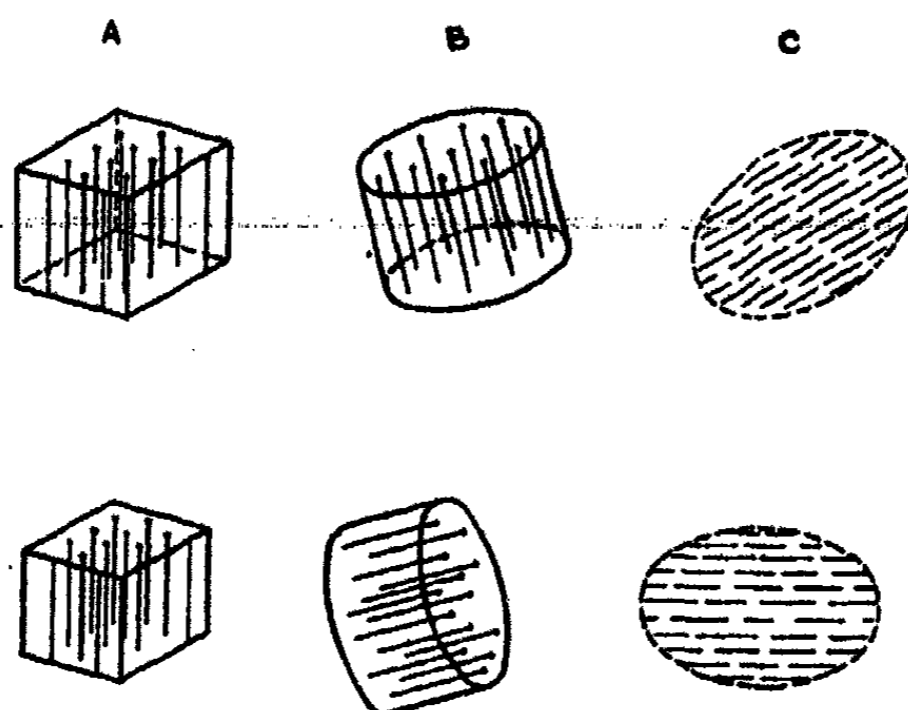

FIG. 1

being assumed that, insofar as statistical conditions permit sufficient parallel ordering of equal length chains, there be formed swarms or droplets of the state B, provided also the thermodynamic conditions admit. In state C, deformation of the swarms is possible in two dimensions, the size-frequency of the swarms depending upon thermal and mechanical (shearing stress) conditions. Such swarms or droplets would not be truly two-dimensional, and would have no *stable magnitude* in any but one dimension, whereas the swarms in B ordering would have limit magnitudes in two dimensions or perpendicular directions. State C implies intermediate degeneration to complete disorder, or kinetic incoherence.

We have obtained evidence in this Laboratory with organic solutions of the cellulose esters, from the measurements of thin films on mercury,<sup>13</sup> that at sufficient dilution the macromolecules are oriented on the mercury at a thickness of the order of magnitude of the thickness of the chains themselves, a result which indicates that dispersion has proceeded as far as state C. Katz<sup>14</sup> entirely independently obtained results in very good concordance with ours for the thickness of thin films of cellulose esters spread on water. It

\* These stages are very possibly related to the smectic and nematic mesophases in liquids of Friedel (*Ann. de Phys.* 18 273 (1922)).

should be mentioned also that there is evidence from the viscosity and plasticity<sup>15</sup> of cellulose ester solutions that by adequate peptization in specific binary solvent mixtures, completely fluid, structureless solutions of cellulose esters may be produced. Here again it appears that dispersion has been carried to state B, if not to state C. Further information in regard to these solution states may be expected from experiments at present in progress under the writer's direction on the birefringence of cellulose ester solutions on being sheared, and its correlation with viscosity and plasticity. We have demonstrated already strong birefringence in these solutions on shearing, showing the presence of asymmetrical particles, and agreeing with our results on the production of optical anisotropy in cellulose ester films by tension.<sup>16</sup>

Quite recently R. Herzog<sup>17</sup> has published data on the characterization of colloidal solutions by the polarization state of the Tyndall beam. With technical cellulose acetate in methyl acetate solution, at 0.08 per cent concentrations, the intensity of the Tyndall beam was almost zero, and residual depolarization was due to the solvent itself. The final values of the depolarization at various higher concentrations were the same, for the same concentration, whether proceeding by dilution of a stronger or concentration of a weaker solution, indicating a completely reversible aggregation ~ disgregation process.

Herzog remarks: "There is present a colloidal solution of the second type," by which he means a hetero- or poly-disperse colloid, as a mobile equilibrium of particles of different degrees of aggregation.

It is evident that this could refer equally to a reversible aggregation of crystallites, of state A, among themselves, or to reversible equilibria between states A, B, and C. There is little evidence that the limiting solutions, at sufficient dilution, are dispersions of the crystallites of the original fibers, and, as has been pointed out, some evidence that they are dispersions of the macromolecules, or at least of nematic swarms of these. The dependence of the Tyndall phenomenon, and of the polarization state of the light upon shearing stress may give further information on this. It should be noted that the dilution at which Herzog found the Tyndall effect to disappear is of the same order as that at which we find "monomolecular" layers are produced. In sum, it appears that in these dispersions and solutions, we have solvated or lyophile colloidal solutions, tending very definitely toward true solutions—hence termed by von Weimarn<sup>18</sup> "solutoid." We can, following this author, provisionally divide cellulose dispersions according to Table II.

Table II indicates that, besides the lyophile sols so far considered, there are possible suspensions and dispersoids of "native" cellulose, or lyophobe sols.

#### Mechanical Dispersion of Cellulose\*

In conjunction with L. W. Eberlin, I have found that by application of wet grinding in pebble or ball mills, cellulose, in the form of cotton fibers or wood pulp, can be dispersed in suitable organic liquids to very finely divided

\* The procedure described is the subject of a U. S. patent application by the writer and L. W. Eberlin.

TABLE II  
Cellulose Dispersions

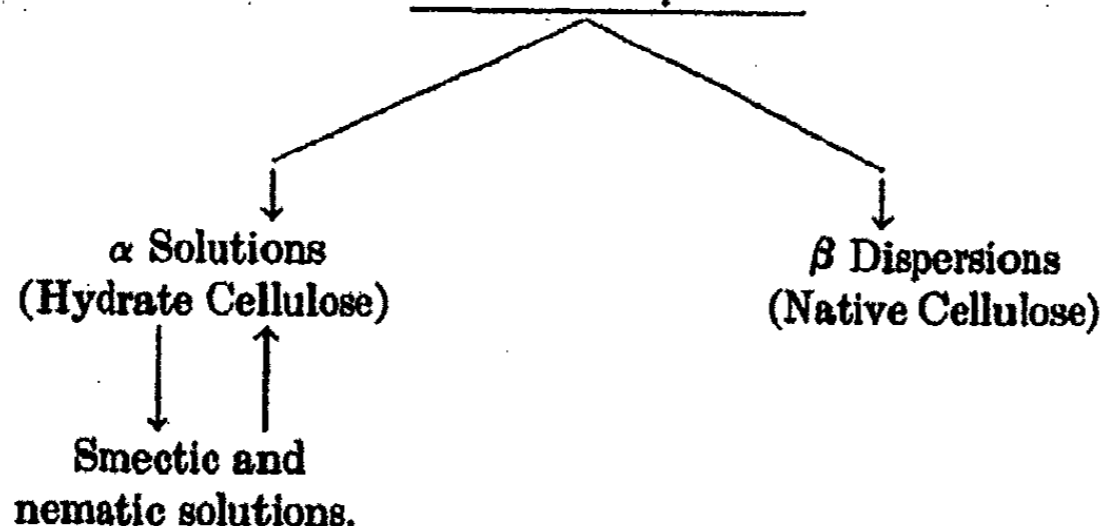

suspensions. A small fraction of this, increasing with time of grinding, becomes colloiddally dispersed. Since beating cellulose in water hydrates the cellulose, with definite displacement toward the "hydrate" form of cellulose, chemically inert organic liquids were tried. When the same ratios of charge of liquid:cellulose:balls, the same mill-radius and *r.p.m.*, were used, it was soon observed that different organic liquids gave very different rates of dispersion of the cellulose. This is brought out in the following table:

TABLE III

Liquid	Mill	Charge	Time for Reduction to 100 Mesh Powder
Acetone	6 gallon jar	500 grams in 15 liters	65 hours
Methyl alcohol	" " "	"	72 "
Ethyl alcohol	" " "	"	90 "
Ethyl acetate	" " "	"	72 "
Turpentine	" " "	"	90 "
Acetic acid	" " "	"	90 "
Benzole	" " "	"	— "
Gasoline	" " "	"	— "
Carbon tetrachloride	" " "	"	— "

These figures are very approximate in regard to the time to produce a given degree of subdivision; they serve to show the broad differences between liquids in the grinding of cellulose. This difference was traced principally to the *friction* between the liquid and the cellulose, a relation confirmed by measurements of the static friction using a glass slider on a cellulose surface lubricated with the liquid in question.<sup>19</sup> The higher the boundary lubrication, in Hardy's sense, the less effective was the liquid, or, conversely, the higher the friction coefficient, the shorter the time of grinding to given subdivision.

Incidentally, these results indicate that in wet grinding in ball mills the disintegration is not effected by *impact*, as probably chiefly occurs in dry grinding, but by shearing of the layer of oriented liquid molecules adhering to the solid particles.

In view of the fact that chemical action between these liquids and cellulose seems precluded (except possibly to a minute extent in the case of acetic acid) it is interesting to note that the viscosity of the solutions in cuprammonium (Schweitzer's) reagent fell *pari passu* with increasing subdivision.

TABLE IV

No.	Cellulose Sample	Original Viscosity	Treatment	Viscosity after Treatment
1	Linters X K	220 c.p.	Ground in ethyl acetate 48 hrs.	75 c.p.
2	"	220 "	Methyl alcohol 44 hrs.	50.3 c.p.
3	"	220 "	Acetone 70 hrs.	36.2 "
4	"	220 "	Acetic acid 48 hrs.	16.3 "
5	"	220 "	Turpentine 48 hrs.	18.5 "
6	H <sub>2</sub> B Linters No. 1	3500 "	Methyl alcohol 96 hrs.	365 "
7	" " " 2	4800 "	Acetone 96 hrs.	200 "
8	" " " 2	4800 "	Acetone 150 hrs.	17 "

It will be seen also that the higher the viscosity of the cellulose initially, the longer the time required to disintegrate to a given degree of dispersions. At the same time, it was observed that the *copper number* was increased by grinding in these liquids. It was suspected first that this might be due to secondary autoxidation, increased by fine subdivision. On carrying out both grinding and drying in an atmosphere of CO<sub>2</sub>, little or no reduction of the increase of copper number was observed. It has been observed by C. Staud and H. LeB. Gray<sup>20</sup> that samples of the same cellulose gave larger copper numbers as the material (paper pulp) was cut up into smaller pieces. The considerable increase in *copper number* which we have found on milling cellulose is no doubt partly explained by sorptive effects caused by increased specific surface. Another part, however, is probably due to the mechanical production of new reactive end-groups, where the fresh surfaces are produced by the shearing of the cellulose aggregates.

#### Dispersed Cellulose and Hydrocellulose

The fine dispersions of cellulose produced as described, *viz.*, by mechanical disintegration in inert organic liquids, behaved in practically all respects

identically with the so-called "hydro-cellulose" produced by the action of more or less diluted mineral acids upon native cellulose. The modified properties include:

- a. Diminished cuprammonium viscosity.
- b. Increased "solubility" in 10 per cent KOH.
- c. Increased reactivity on esterification.
- d. Increased adsorption of basic dyes.

The production of "hydrocellulose" by treatment of cellulose with mineral acids is not attended by obvious increase of dispersity, in that the fibers may remain apparently unaltered. It is well known, however, that such treatment results in "tendering" of the fiber. It has been shown by Farrow and Neale,<sup>21</sup>

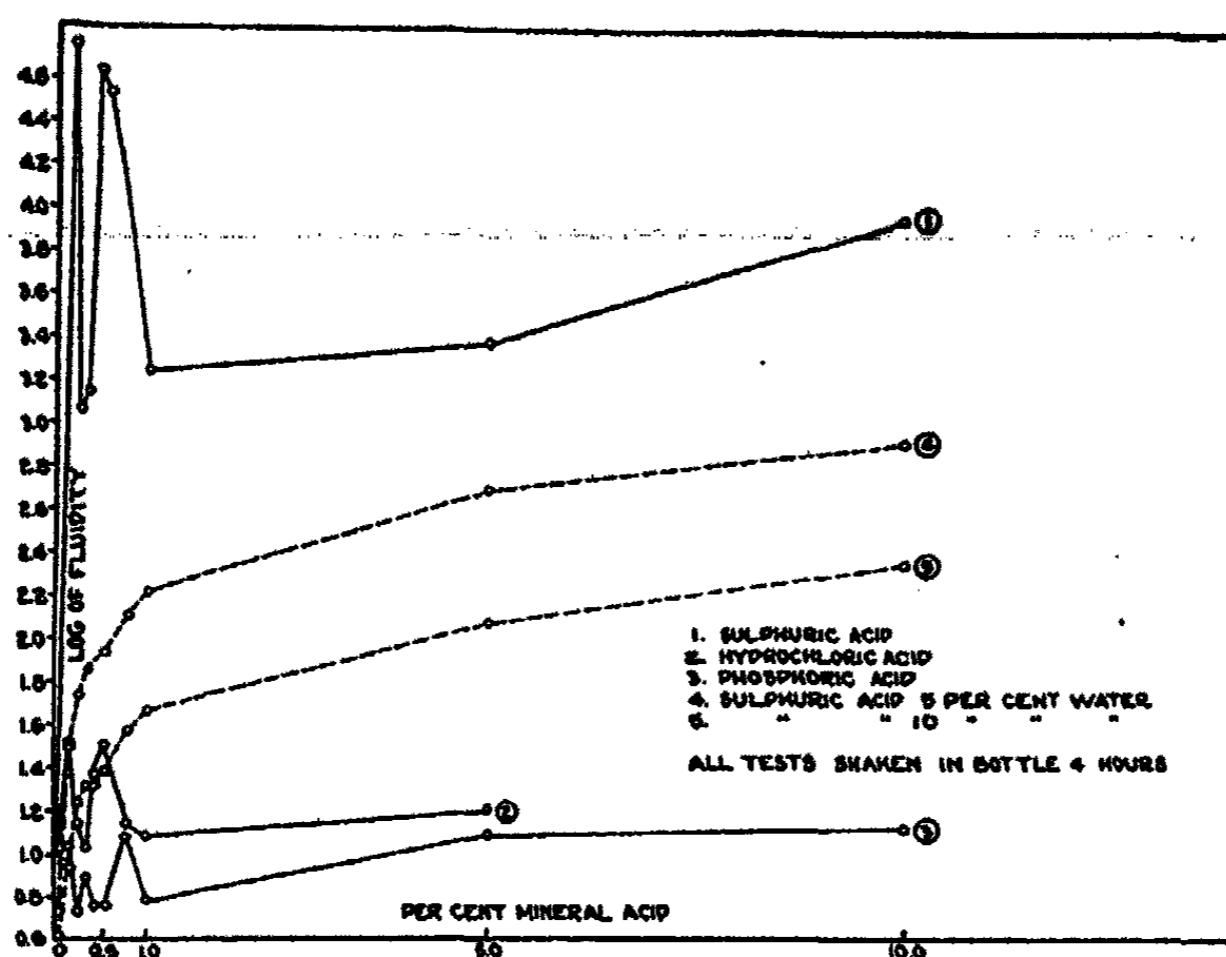

FIG. 2

and we have confirmed their results, that the fiber strength diminishes progressively with decrease in cuprammonium viscosity. It appears justifiable therefore to speak of a "latent peptization" or of an increase in latent dispersity having been effected. This agrees with the fact, to be noted specifically shortly, that the combination of acidic treatment with mechanical shearing results in a great acceleration of the actual disintegration of cellulose to fine powders and suspensions.

The property expressing the modification of the cellulose produced by acidic treatment which can be most readily measured is the cuprammonium viscosity. It is preferable to express this by its reciprocal, the *fluidity*, and since the scale of values is very extended, by the logarithm (common or Briggs') of the fluidity. A general comparison of the actions of *sulfuric hydrochloric*, and phosphoric acids in acetic acid solution is shown in Fig. 2. The data give the values of  $\log \phi$  for four hours' treatment at room tem-

perature—25° C.—of cellulose (cotton linters) shaken with 12:1 liquid to solid for four hours. In each case, the initial value  $\log \phi = 1.0$  refers not to the original viscosity of untreated cellulose, but to the cellulose after four hours' treatment in (glacial) acetic acid alone.

Comparison of the action of the mineral acids is preferably on a basis of molar equivalents (cf. Fig. 3) but this does not affect the main features. It appears that sulfuric acid is much more effective than hydrochloric acid, and that hydrochloric acid is more effective than phosphoric. Certain singularities which appear require comment. There is a marked *fluctuation* in the activity of low concentrations of the mineral acids—up to one per cent,

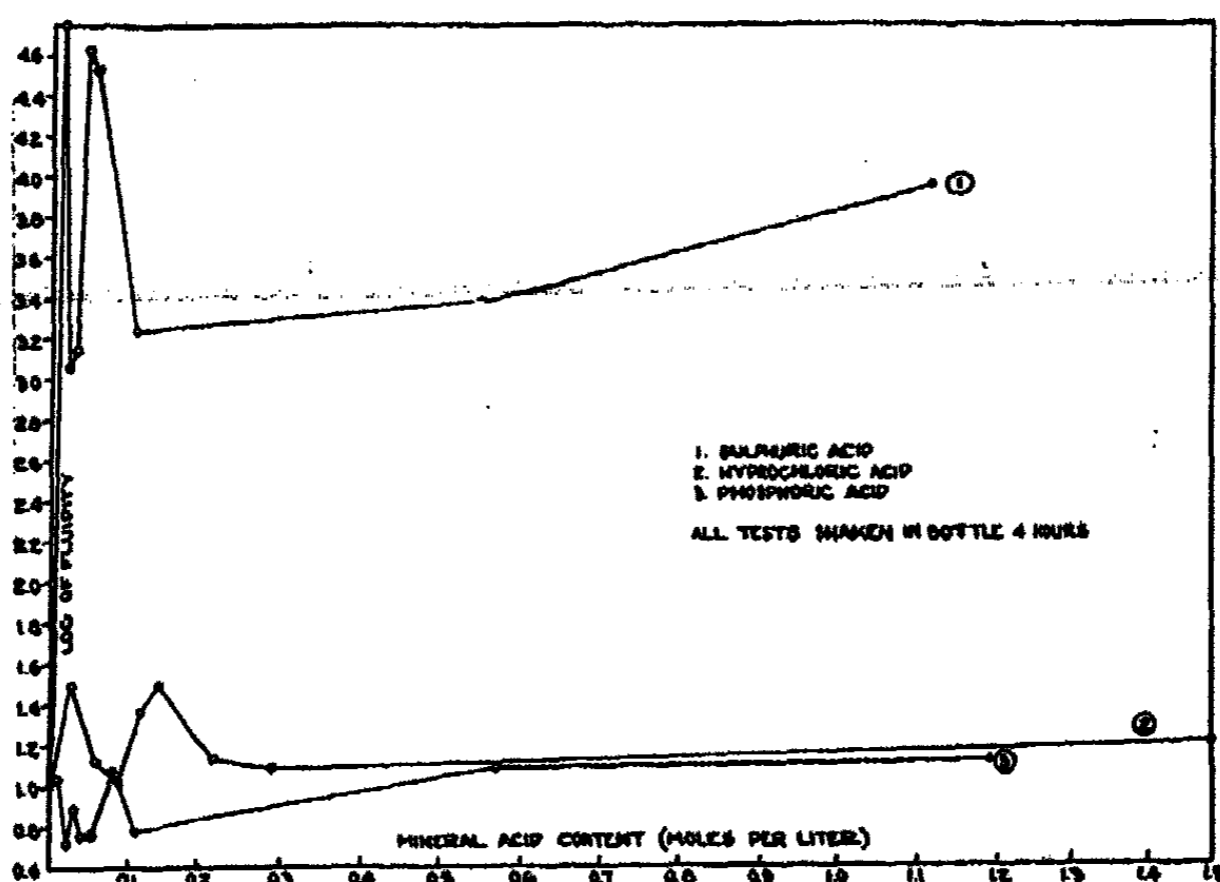

FIG. 3

maxima and minima appearing on the curve. These are greatly reduced by the additions of 5 and 10 per cent water to the mixture, and appear to be connected with the presence of the small amounts of water in the cellulose and the acetic acid. It is possible that a mixture having a very small amount of water has a much greater effect than either anhydrous or more aqueous solutions. Electrometric measurements of the "activity" of these super acid solutions, by the method of Conant, point in this direction, but the phenomenon is being studied more closely.

Otherwise, the action of the mineral acids is lessened as the amount of water is increased. This, and the relative efficiencies of the mineral acids would indicate that we are dealing with the activity of super acid solution. The result showing small amounts of phosphoric acid to have a relatively negative effect may indicate that phosphoric acid at these concentrations inhibits somewhat the action of acetic acid itself. Comparison of the action of sulfuric acid at different concentrations for different times up to four hours is shown in Fig. 4 and Fig. 5.

It will be seen here that the mechanical disintegration and the chemical attack superpose in accelerating the disintegration of the cellulose.

More work both on the ultra-microscopic and the X-ray side is required before the character of these effects can be defined with precision. At present, it appears that there is a loosening of the cohesion between the cellulose crystallites of the fiber, which possibly passes over into an actual disorientation and shortens the primary valency chains composing them. As the concentration of the mineral acids is increased, it is known that bodies of lower molecular weight, sugars and sugar derivatives, are formed from the cellulose.

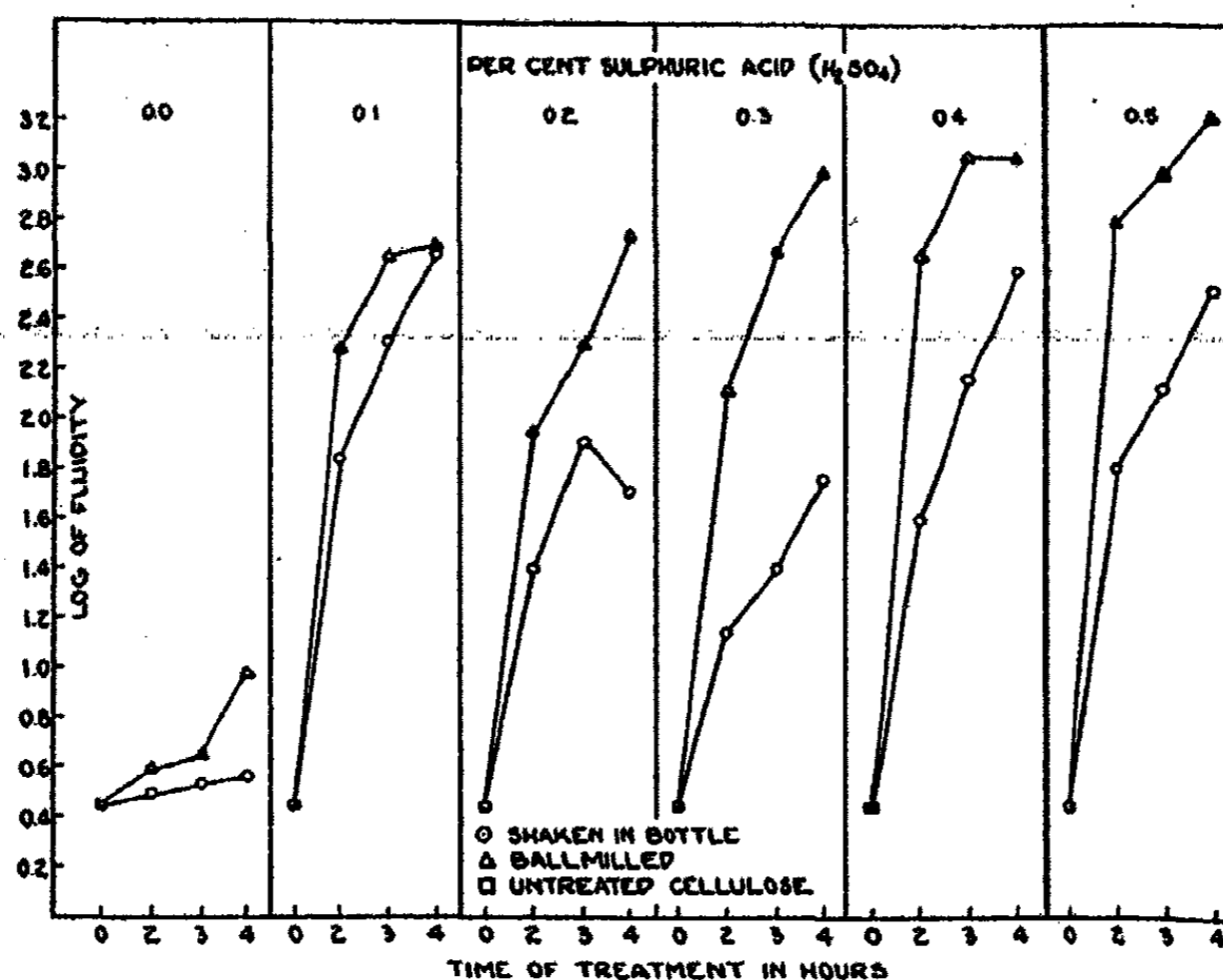

FIG. 4

In any case, the peptization of cellulose fibers in these acid solutions shows certain resemblances to the etching and corrosion of metals and their oxides. In both cases we are dealing with topochemical reactions of the space lattices of solids. The influence of small amounts of "impurities" in metals in affecting their rates of corrosion is very probably paralleled with cellulose fibers by the "non-uniformity" of the material, which depends upon local differences in the amounts and distributions of non-cellulose materials.

#### Nature of Hydrocellulose Formation

Although agreeing in a broad way in the properties mentioned, the degraded or "hydro-celluloses" produced by:

- a. action of mineral acids in glacial acetic
- b. action of mineral acids in water
- c. action of inert organic liquids in pebble mill

show certain differences in the relative exaltation of certain factors. Even when brought to the same level of mechanical subdivision, there exist fine

differences of the inner or latent dispersity which appear only in degrees of reactivity. This is comprehensible, when we consider that we are probably dealing with three different processes of degradation or disgregation.

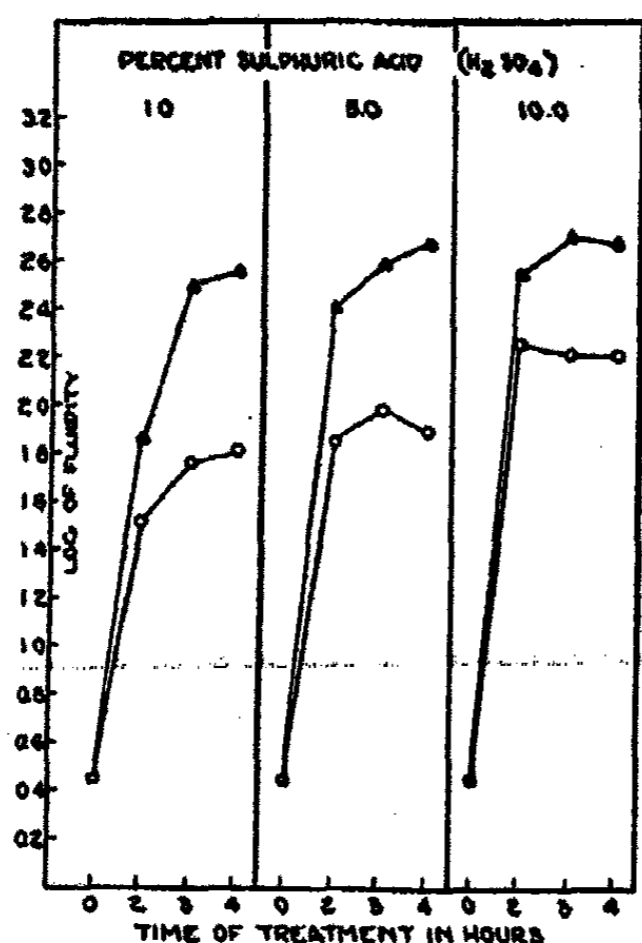

FIG. 5

In case (a), we have a process of *acetolysis*, probably of the  $-C-O-C-$  or oxygen bridges, this process being catalyzed by the mineral acids in super-acid solutions. The relative activities of the mineral acids observed are in agreement with this. The process probably involves a small fixation of acetyl on end groups of the residual (broken) chains, but not necessarily any true acetylation.

In case (b), we have a process of *hydrolysis*, again probably of the  $-C-O-C-$  or oxygen bridges. This process is also catalyzed by mineral acids, but being in aqueous solution, their activities are much less, and the order of their activities different, *e.g.*, HCl is now stronger than H<sub>2</sub>SO<sub>4</sub>. Finally, in case (c), we have probably a

repeated shearing off of atom groups of the cellulose material attached to strongly oriented (adsorbed) dispersent.

The finer topochemical differences which result from these different modes of attack are chiefly evident in chemical reaction, but eventually may be revealed by X-ray investigation.

#### References

- <sup>1</sup> P. von Weimarn: *Kolloid-Z.*, 11, 41 (1912).
- <sup>2</sup> A. W. Schorger: "Chemistry of Cellulose and Wood, 310, (1926).
- <sup>3</sup> P. von Weimarn: *loc. cit.*
- <sup>4</sup> H. E. Williams: *Manchester Memoirs*, 65: 12 (1921); *cf.* also Cross and Bevan: "Researches" (1910-1921).
- <sup>5</sup> J. R. Katz and H. Mark: *Z. physik. Chem.*, 115, 358 (1925).
- <sup>6</sup> *Cf.* S. E. Sheppard and P. T. Newsome: *J. Phys. Chem.* 33, 1817 (1929.)
- <sup>7</sup> C. E. Guignet: *Compt. rend.*, 108, 1258 (1889).
- <sup>8</sup> E. Knecht: *J. Soc. Dyers Colourists*, 12, 89 (1896).
- <sup>9</sup> *Cf.* A. W. Schorger: "Chemistry of Cellulose and Wood, 310 (1926).
- <sup>10</sup> S. E. Sheppard and P. T. Newsome: *loc. cit.*
- <sup>11</sup> R. Herzog: *J. Phys. Chem.*, 30, 457 (1926).
- <sup>12</sup> K. H. Meyer and H. Mark: *Ber.*, 61, 593 (1928).
- <sup>13</sup> S. E. Sheppard and R. L. Keenan: *Nature*, 121, 982 (1928).
- <sup>14</sup> J. R. Katz and P. J. P. Sanwel: *Naturwissenschaften*, 16: 27, July (1928).
- <sup>15</sup> S. E. Sheppard and R. C. Houck: *J. Rheology*, 1, 20 (1929).
- <sup>16</sup> J. G. McNally and S. E. Sheppard: *J. Phys. Chem.* 36, 165 (1930).
- <sup>17</sup> R. Herzog and B. Lange: *Ber.*, 52, 491 (1929).
- <sup>18</sup> P. von Weimarn: *Japanese Journal of Chemistry*, 3, 71 (1928).
- <sup>19</sup> W. Hardy and I. Bircumshaw: *Proc. Roy. Soc.*, 108, 1 (1925).
- <sup>20</sup> H. LeB. Gray and C. J. Staud: *Ind. Eng. Chem.*, 19, 854 (1927).
- <sup>21</sup> F. D. Farrow and S. M. Neale: *J. Text. Inst.*, 1924, T157.

Rochester, N. Y.  
November 4, 1929.



## AN EQUATION OF STATE FOR SOIL NITROGEN

BY HANS JENNY

In this paper, soils are approached from the viewpoint of a general theory of state (*allgemeine Zustandslehre*) in which soil properties, soil processes, and soil-forming factors are united into a comprehensive system. At present, field soil investigations are still largely in a descriptive stage in which emphasis is laid on the accumulation of data. This is quite a natural and necessary phase in the development of a young science. Fortunately there are now available sufficient data, at least along certain lines, to permit a search for functional relationships. If one is aware that soil formation is a chemical process in the broadest sense (including physiochemical and biochemical reactions), the possibility of combining soil characteristics and their conditioning parameters into a series of mathematical equations is at once suggested. Such equations of state<sup>1</sup> would completely describe the behavior of soil properties under any external conditions and, at the same time, put field soil investigations upon an adequate scientific basis. The finding of such a "characteristic equation" for soil constituents is the object of this paper.

Of the various soil properties that have been studied, the total nitrogen content, as determined by the Kjeldahl method, has probably attracted most attention. It has been found that the amount of total soil nitrogen varies greatly with soil texture, topography, nature of substrata, vegetation and climate. The last one of these factors is of special interest from the equation of state viewpoint, because it is a determining, external factor, not inherent in the parent material, and one which can be measured and expressed numerically. For mature soils, having similar texture, topography and vegetation, the following equation will thus hold:

$$\text{Soil nitrogen} = f(\text{climate}) \quad (1)$$

From the standpoint of soil formation, the temperature, the precipitation and the evaporation are the most important climatic factors. Precipitation and evaporation are often combined into a quotient, called "moisture factor" or "humidity factor," which allows one to write equation (1) in the form:

$$N = f(T, H) \quad (2)$$

where  $N$  represents total nitrogen content of soil,  $T$ , air temperature and  $H$ , humidity factor. For the solution of equation (2) which contains one dependent ( $N$ ) and two independent ( $T, H$ ) variables, it is advisable to write it in the form of a differential equation:

$$dN = \left( \frac{\partial N}{\partial T} \right)_H dT + \left( \frac{\partial N}{\partial H} \right)_T dH \quad (3)$$

If the nature of the two partial differential coefficients  $(\partial N / \partial T)_H$  and  $(\partial N / \partial H)_T$  be known, one might be able to integrate equation (3) and obtain a solution of equation (2):

<sup>1</sup>G. N. Lewis and M. Randall: "Thermodynamics", 27 (1923).

$(\partial N/\partial T)_H$  represents the first differential coefficient of the function  $[N]_H = f(T)$  which connects soil nitrogen with temperature in regions of constant humidity factors. This so-called nitrogen-temperature relation was previously studied for the semiarid, semihumid and humid regions of the United States.<sup>1</sup> For loamy grass-land soils the relation is given by the

equation  $[N]_H = \frac{a}{1 + e^{-kT}}$  (where  $a$  and  $k$  are constants) which was obtained

from theoretical reasoning, based on the effect of temperature on the activity of microorganisms. This nitrogen-temperature relation, however, can also be described satisfactorily by the simpler empirical equation:

$$[N]_H = C_1 e^{-k_1 T} \quad (4)$$

where  $N$  = average total nitrogen content of upland loamy grassland soils (surface 6-8 inch section) in per cent.

$T$  = mean annual centigrade temperature ( $0^\circ$ - $22^\circ$ , corresponding to the temperature range from Canada to the Gulf of Mexico.)

$C_1$  = constant, which includes  $H$ .

$k_1$  = absolute constant (within experimental range).

Taking logarithms, equation (4) becomes:

$$\log_e [N]_H = \log_e C_1 - k_1 T \quad (5)$$

Its differential coefficient has the form:

$$(\partial N/\partial T)_H = -k_1 N \quad (6)$$

which is the required first partial derivative of the differential equation (3).

$(\partial N/\partial H)_T$  represents the first differential coefficient of the function  $[N]_T = f(H)$  which connects soil nitrogen with humidity factors in regions of constant temperature. This so-called nitrogen-humidity factor relation has also been investigated previously.<sup>2</sup> For loamy grass-land soils in the temperate and subtropical regions of the United States, the relation was found to be of the form:

$$[N]_T = A(1 - e^{-k_2 H}) \quad (7)$$

where  $N$  = average total nitrogen content of upland loamy grass-land soils (surface 6-8 inch. section). in per cent.

$H$  = humidity factor, expressed as annual N. S. Quotient<sup>3</sup> (0-400).

$A$  = constant, which includes  $T$ .

$k_2$  = absolute constant (within experimental range).

Taking logarithms, equation (7) becomes:

$$\log_e [N]_T = \log_e A + \log_e (1 - e^{-k_2 H}) \quad (8)$$

Its differential coefficient has the form:

$$(\partial N/\partial H)_T = \frac{k_2 e^{-k_2 H} N}{1 - e^{-k_2 H}} \quad (9)$$

<sup>1</sup> Soil Science, 27, 169-188 (1929).

<sup>2</sup> Soil Science, 29, (1930) (in print).

<sup>3</sup> A substitute for the true precipitation-evaporation ratio was used, namely, the so-called N. S. Quotient, which is obtained by dividing the precipitation by the absolute saturation deficit of the air.

which is the required second partial derivative of the differential equation (3). Combining the partial differential equations (7) and (9) with the differential equation (3) results in:

$$dN = -k_1 N dr + \frac{k_2 e^{-k_2 H} N}{1 - e^{-k_2 H}} dH \quad (10)$$

After dividing the entire equation by  $N$ , the integration can be performed at sight. Assuming that  $k_1$  and  $k_2$  are absolute constants, the integrated equation takes the form:

$$\log_e N = -k_1 T + \log_e(1 - e^{-k_2 H}) + c \quad (11)$$

or

$$N = C e^{-k_1 T} (1 - e^{-k_2 H}) \quad (12)$$

Since this equation is entirely an empirical one, the observational limits for  $T = 0^\circ - 22^\circ$  and  $H = 0 - 400$  should be constantly kept in mind.

Equation (12) gives the following information regarding the occurrence of soil nitrogen:

1) If  $H = 0$  also  $N = 0$ , or in other words, in desert regions the nitrogen content of the soil tends to be very low, no matter whether the deserts lie in northern or southern zones.

2) With an increasing humidity factor, soil nitrogen *increases* logarithmically. The rate of increase is greatest in northern regions (Canada) and smallest in southern regions (Texas).

3) With increasing temperature, soil nitrogen *decreases* exponentially. The rate of decrease is greatest in humid regions and smallest in arid regions. Southern regions have less nitrogen in the soil than northern regions, provided equal moisture districts are compared.

As to the numerical magnitudes of the constants, the following experimental values were previously obtained:

TABLE I  
Values of the Constants

Regions	Humidity factor (N. S. Q.)	$k_1$	Temperature	$k_2$
Semiarid	125 - 250	0.073	—	—
Semihumid	280 - 380	0.095	—	—
Humid	300 - 420	0.101	—	—
Temperate	—	—	10.6° - 11.7° C	0.0034
Subtropical	—	—	17.8° - 20.0° C	0.0073

On account of a certain heterogeneity of the analytical material, some arbitrary selection in choosing the constants cannot be avoided. The following values satisfy the equation for a *first approximation*:

$$\begin{aligned} k_1 &= 0.08 \\ k_2 &= 0.005 \\ C &= 0.55 \end{aligned}$$

TABLE II  
Observed and calculated values of the soil nitrogen-temperature-humidity factor-equation

Annual Tempera- ture C°	Annual Humidity factor (N. S. Q.)	Average total nitrogen content of soil (per cent.)		Regions
		Observed	Calculated	
0.0	350	0.47	0.45	Southcentral Canada (Saskatchewan, Manitoba)
2.2	200	± 0.29	± 0.050 <sup>1</sup>	Southwest Saskatchewan and Northwestern North Dakota
	380	± 0.34	± 0.017	Southeast Saskatchewan and Northeastern North Dakota
4.4	220	± 0.24	± 0.015	Southwestern North Dakota
	350	± 0.30	± 0.017	Southeastern North Dakota
5.6	380	± 0.27	± 0.018	West central Minnesota
6.7	350	± 0.27	± 0.012	South central Minnesota
	420	± 0.30	± 0.028	West central Wisconsin
7.8	420	± 0.26	± 0.011	Southwest Wisconsin
8.9	320	± 0.21	± 0.014	Northwestern Iowa
	380	± 0.28	± 0.016	Northern Illinois
10.0	230	± 0.19	± 0.012	South central Nebraska
	350	± 0.17	± 0.005	Southern Iowa
11.0	75	± 0.08	± 0.009	Southeastern Colorado
	125	± 0.11	± 0.007	East central Colorado and Northwestern Kansas
	275	± 0.20	± 0.005	Northeastern Kansas and Northwestern Missouri
	325	± 0.19	± 0.005	Northcentral Missouri
	375	± 0.22	± 0.008	Central Illinois
13.3	350	± 0.16	± 0.020	Southern Illinois
14.4	150	± 0.09	± 0.006	Texas Panhandle
16.7	350	± 0.12	± 0.016	Northern Mississippi
19.0	150	± 0.08	± 0.007	Central Texas
	250	± 0.095	± 0.006	Eastern Texas
	350	± 0.10	± 0.006	Central Mississippi
22.2	200	± 0.075	± 0.004	Southern Texas

<sup>1</sup> Mean error.

Equation (12) takes then the form:

$$N = 0.55e^{-0.08T}(1 - e^{-0.005H}) \quad (13)$$

A comparison between calculated and observed average soil nitrogen values is given in Table II, and the corresponding nitrogen plane is shown in the three-dimensional graph of Fig. 1.

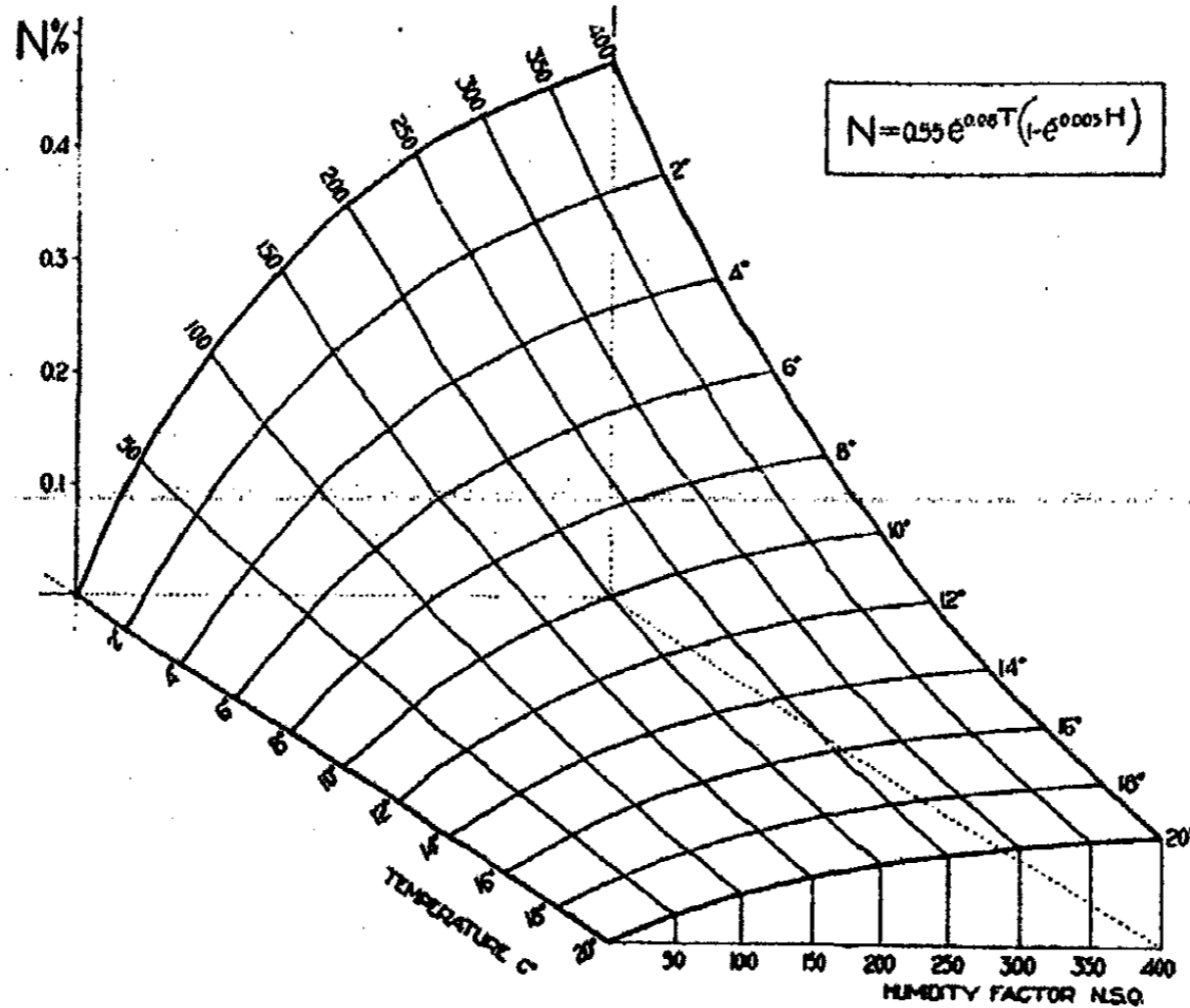

FIG. 1

The nitrogen content of loamy grassland soils in the United States as a function of annual temperature and annual humidity factor (N.S.Q.)  
The curves express the approximate trend of soil nitrogen of large areas.

Although this investigation is based on more than 1000 soil nitrogen values equation (13) must not be considered as final. From certain large areas no nitrogen analyses could be secured (e.g. Oklahoma, South Dakota) and in general the number of analyses from arid regions is too small to determine accurately the magnitude of the constant  $k_2$ . One should also remember that equation (10) was integrated on the assumption that  $k_1$  and  $k_2$  are absolute constants. It is quite possible that, in refining equation (13), a variation of the constants themselves may occur.

Nevertheless, the agreement between calculated and observed data indicates that equation (13) is satisfactory for a first approximation, and, moreover, it shows that an equation of state viewpoint in field soil investigations can be applied with success.

*Department of Soils,  
University of Missouri,  
Columbia, Mo.*

## THE SYSTEM POTASSIUM SULPHATE-MAGNESIUM SULPHATE-WATER<sup>1</sup>

BY B. A. STARRS<sup>2</sup> AND LOYAL CLARKE<sup>2</sup>

The existing data on the system potassium sulphate, magnesium sulphate, and water for the temperature range 20-30°C. are fairly concordant except for the work of Weston<sup>3</sup> at 30°C. His results indicated that magnesium sulphate heptahydrate was not the solid phase at concentrations indicated by other workers, but that mixed crystals were formed under these conditions. The solubilities given by Weston for schönite and the other solid phases were at variance with those of other experimenters.<sup>4,5,6,7</sup> A few preliminary experiments were made which corroborated the work of Levi, van Klooster, and Basch and indicated that the work of Weston was in error. To test these conclusions a more accurate and complete solubility study of the system was undertaken.

### Experimental Procedure

Calculated amounts of pure potassium sulphate, magnesium sulphate, and water were placed in test-tubes stoppered with paraffined corks. The corks and part of the tubes were covered with rubber caps. The equilibria were approached from both sides, the supersaturation side being obtained by heating the mixture to boiling so that the solids were completely dissolved. The test-tubes were strapped to a brass disc which was immersed in a water bath and rotated about a horizontal axis which was perpendicular to the plane of the disc. This agitation was continued for at least 5 hours. The temperature of the bath was maintained at  $30^{\circ} \pm 0.1^{\circ}\text{C}$ ., the temperature being measured by a U. S. Bureau of Standards certified thermometer. At the conclusion of the agitation period the tops of the tubes were raised above the level of the water in the bath, the stoppers removed, and samples withdrawn by means of a 10 cc. pipette provided with a removable cotton plug filter. After obtaining the samples the remainder of the mixture was filtered rapidly through a Gooch crucible in order to obtain the solid phase for examination. No attempt was made to carry out the latter operation at constant temperature; however, the room temperature in all but one case was above 25°C.

<sup>1</sup> Published by permission of the Director, U. S. Bureau of Mines. (Not subject to copyright.)

<sup>2</sup> Junior chemist, U. S. Bureau of Mines, Nonmetallic minerals experiment station, New Brunswick, N. J.

<sup>3</sup> Weston: *J. Chem. Soc.*, 121, 1223 (1922).

<sup>4</sup> Levi: *Z. physik. Chem.*, 106, 93 (1923).

<sup>5</sup> Van Klooster, *J. Phys. Chem.*, 21, 513 (1917).

<sup>6</sup> Van't Hoff (Basch) "Zur Bildung der Ozeanischen Salzablagerungen", p. 16 (1905)

<sup>7</sup> "International Critical Tables", 4, 352 (1928).

In every case the sample was analyzed for potassium sulphate and magnesium. Only single analyses were run, since the sulphate determination provided an adequate check on the potassium and magnesium analyses. Magnesium was determined by the method of W. Gibbs.<sup>8</sup> Sulphate was determined by hot precipitation with barium chloride in slightly acid solutions. Potassium was determined as platinum obtained by reducing potassium chloroplatinate, in hot acid solution with metallic magnesium. This method gave consistently high results, which were corrected by employing an experimental factor 0.988 times the theoretical value. The solids were analyzed qualitatively whenever possible and quantitatively when necessary. Magnesium was detected as magnesium ammonium phosphate and the potassium as potassium cobaltic nitrite. The solids were also examined with a petrographic microscope.

### Results

The solubility data obtained are given in Table I and plotted in Fig. 1. The values given for the solubilities of potassium and magnesium sulphates are those obtained from Mellor. In Table I those experiments which are marked "S" were points obtained from the supersaturation side. It will be observed that points obtained from both sides show no systematic differences. In the cases where either potassium sulphate or magnesium sulphate heptahydrate was a solid phase, this agreement is sufficient proof that equilibrium had been established. When schönite ( $K_2SO_4 \cdot MgSO_4 \cdot 6H_2O$ ) was the only solid phase or one of the solid phases, this proof is not entirely conclusive.

It should be mentioned that three points were obtained from the supersaturation side which were much higher than similar points from undersaturation. A longer period of agitation was then employed, and the repeated points so obtained were in agreement with those from undersaturation. These three anomalous points were omitted from Table I and Fig. 1. The reproducibility of the results appears to be well within  $\pm 0.2$  gram per 100 grams of water.

Column 4 of Table I indicates the difference between the per cent  $K_2SO_4$  found by the chloroplatinate method and that found by way of the sulphate determination. It will be observed that these differences are negative, with few exceptions, and that the sulphate method yielded results which were too high. Column 5 of Table I lists the solid phases as determined by petrographic examination and qualitative tests. In column 2 the figures enclosed in brackets represent data obtained for the invariant points, and are averaged to obtain the figures labelled "mean."

In Fig. 1 line A-B represents the solubility of potassium sulphate, line B-C the solubility of schönite, and line C-D that of magnesium sulphate heptahydrate. Two of the three residues from the experiments which determined the line C-D contained only very small amounts of potassium sulphate, and the third contained 1 percent of potassium sulphate. This value is, however, no larger than would be expected from the potassium content of the

<sup>8</sup> Am. J. Sci., (3) 5, 114.

TABLE I

Method of getting salts in solution	Grams $K_2SO_4$ per 100 g. $H_2O$	Grams $MgSO_4$ per 100 g. $H_2O$	% $K_2SO_4$ found— % $K_2SO_4$ calcul. from $BaSO_4$	Solid phase
	(13.11)	0.00	—	$K_2SO_4$
	14.24	4.80	+ .39	"
	15.41	11.97	+ .05	"
S	15.11	12.10	— .34	"
	15.04	14.85	— .05	"
S	15.34	16.00	+ .17	"
	15.31	16.08	+ .01	"
	(15.53)	(17.42)	— .06	" , $K_2SO_4 \cdot MgSO_4 \cdot 6H_2O$
S	15.23	(17.77)	— .18	" , "
	(15.34)	(17.97)	.00	" , "
mean	15.33	17.72		" , "
	14.45	18.51	— .89	"
	11.29	26.17	— .54	"
S	8.89	31.78	— .48	"
S	7.34	35.95	— .03	"
	7.19	37.43	— .20	"
	6.55	39.35	— .94	"
S	6.48	39.36	— 1.06	"
	(6.50)	(39.85)	— .83	$MgSO_4 \cdot 7H_2O$ , "
	(6.60)	(39.97)	— .24	" , "
mean	6.55	39.91		" , "
S	5.53	39.13	— .86	"
	5.79	39.29	— .40	"
	3.33	39.10	— .73	"
		(40.91)	—	"

solution adhering to the crystals. No evidence was found for the mixed crystals reported by Weston either by analysis or by microscopic examination.

The data obtained by Weston are plotted as the curve A'B'C'D' for comparison with that of the authors. In almost every case Weston's figures are much the higher of the two with respect to the potassium sulphate concentration; this indicates that the solutions used by Weston were supersaturated in spite of several hours agitation. More specifically the solutions of Weston along line A-B were doubtless supersaturated with respect to potassium sulphate. At point C' and points near it Weston clearly had supersaturation with respect to schönite. The ease with which supersaturated solutions of schönite can be obtained was shown by the discarded experiments referred to above, in which the authors obtained supersaturated solutions



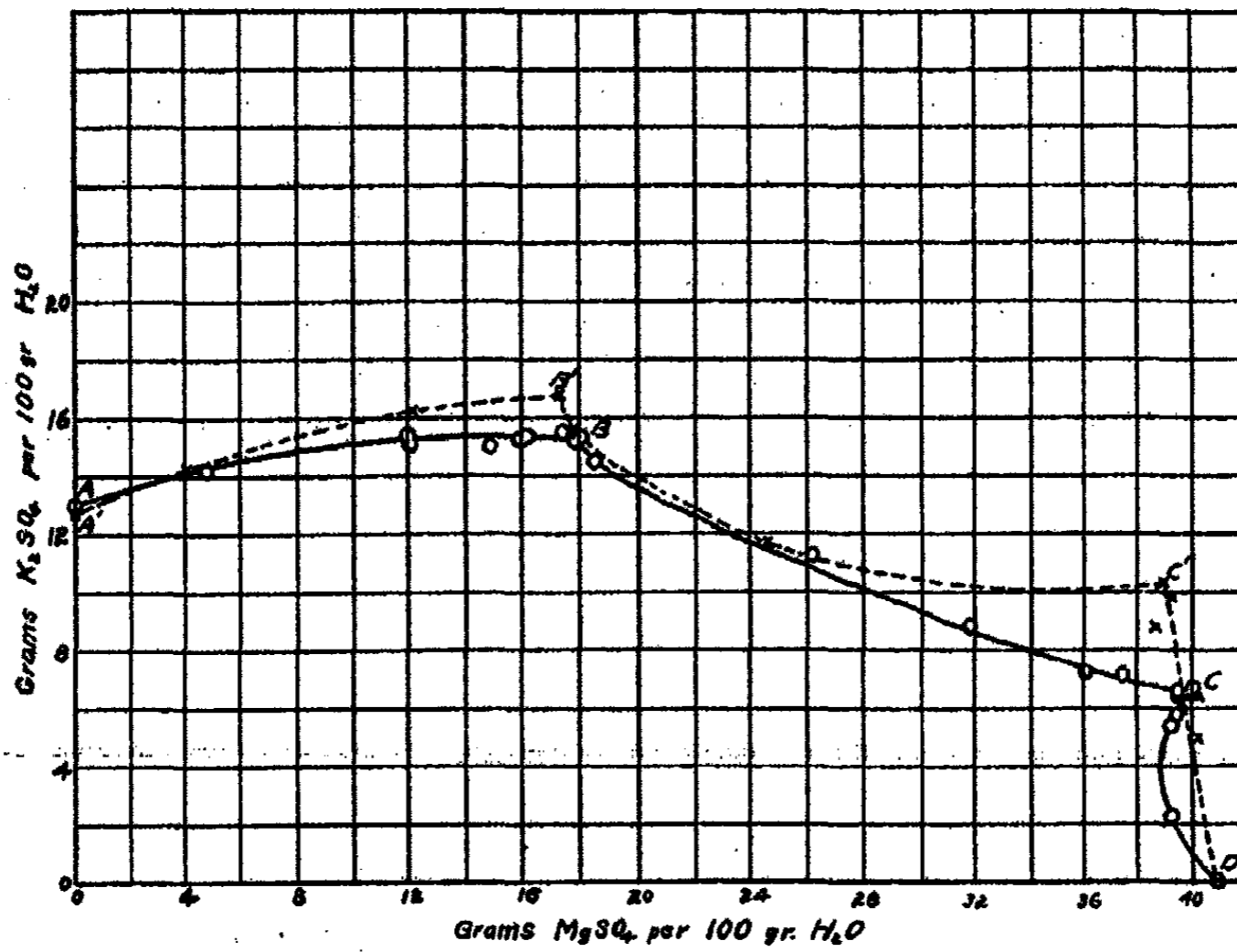

FIG. 1  
The System  $K_2SO_4$ - $MgSO_4$ - $H_2O$  at  $30^\circ C$ .  
The broken line curve represents Weston's data, and the solid line that of the authors.

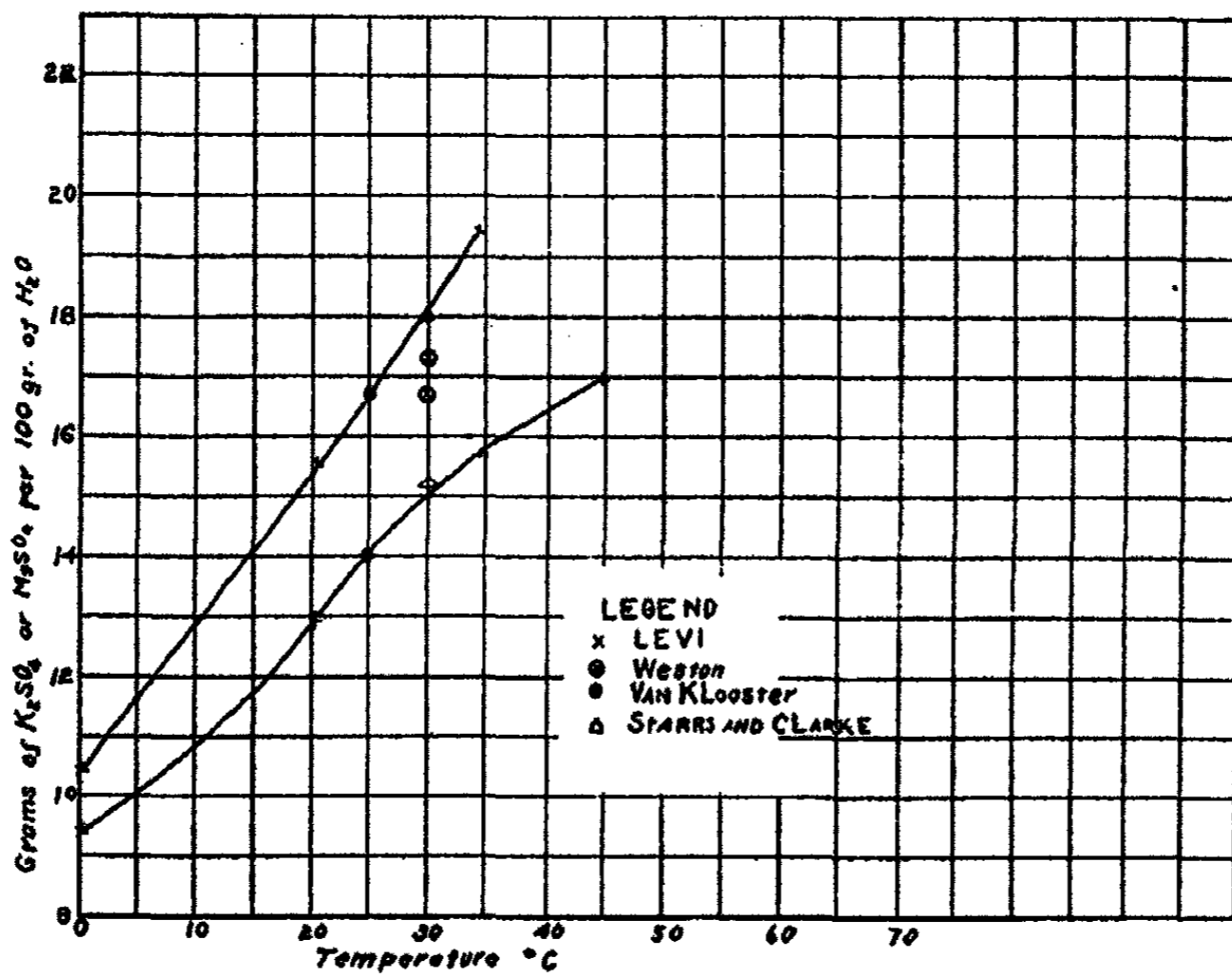

FIG. 2  
Monovariant Point "B."  
Solid Phases  $K_2SO_4$  and  $K_2SO_4 \cdot MgSO_4 \cdot 6H_2O$ .

even after very violent agitation for several hours. Since Weston's solutions corresponding to points C' and C were supersaturated, the solid residues would contain varying amounts of potassium and magnesium sulphates, depending upon the completeness of the crystallization of schönite. Such results might readily lead to the erroneous conclusion that mixed crystals constituted the true solid phase. In the case of Weston's points below the point C, the solid phase should have been pure  $\text{MgSO}_4 \cdot 7\text{H}_2\text{O}$ . Of the two points so obtained by Weston it is significant that one is almost identical with point C of the authors, whereas the residue from the other contained only 1 percent  $\text{K}_2\text{SO}_4$ , an amount which could have been entirely due to adhering mother liquor.

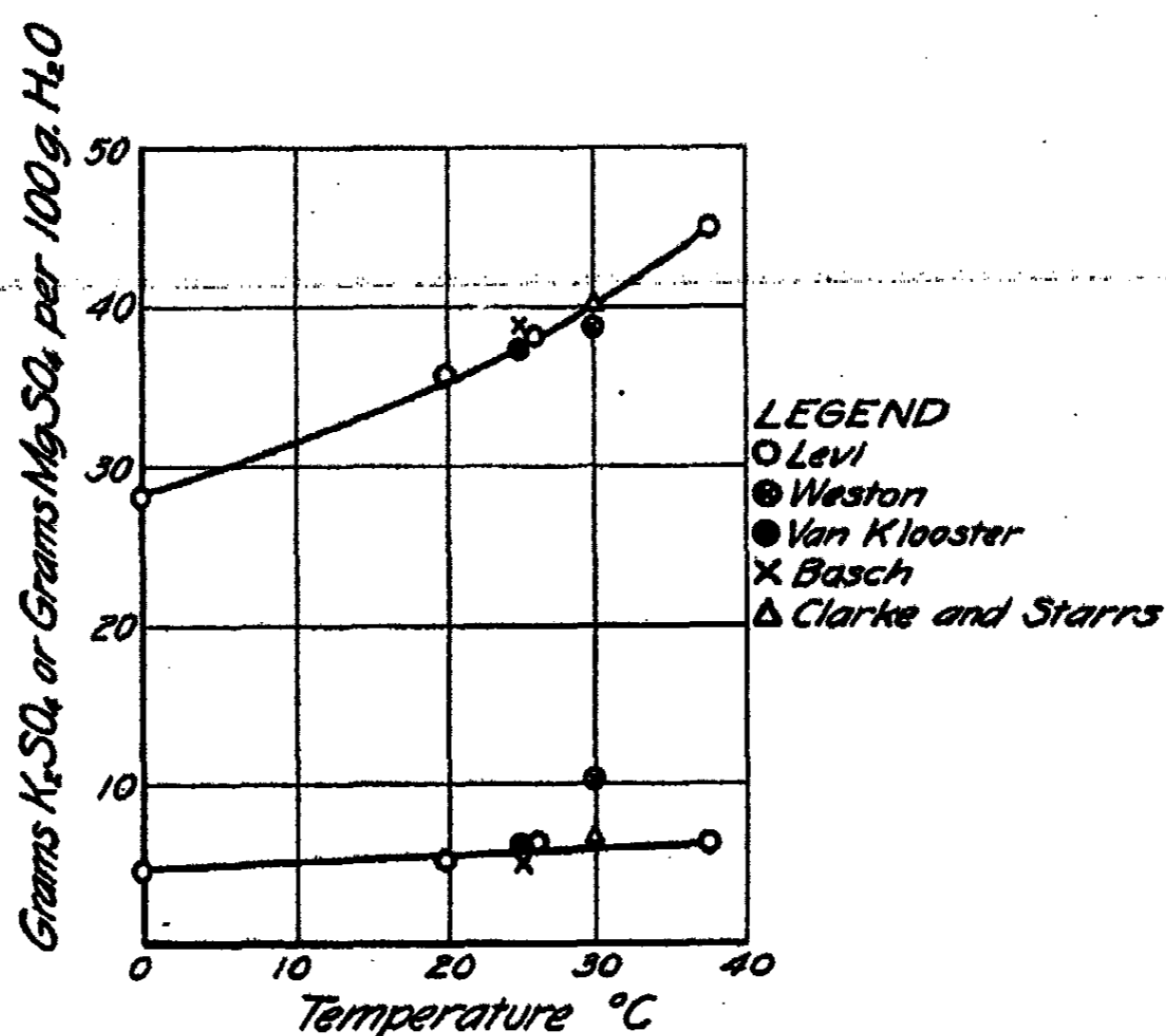

FIG. 3  
Monovariant Point "C"  
Solid Phases  $\text{K}_2\text{SO}_4 \cdot \text{MgSO}_4 \cdot 6\text{H}_2\text{O}$  and  $\text{MgSO}_4 \cdot 7\text{H}_2\text{O}$ .

The two monovariant points B and C obtained by the authors are compared with those obtained by other experimenters in Figs. 2 and 3. It will be observed that the work of van Klooster, Levi, and that of the authors is in close agreement, whereas the points obtained by Weston are consistently higher with respect to the potassium sulphate concentration.

In connection with supersaturation in Weston's experiment corresponding to the point B', it might be mentioned that the authors experienced considerable difficulty in crystallizing pure potassium sulphate from a solution containing magnesium sulphate at concentrations slightly less than that corresponding to point B. It was found that rapid cooling of such a solution resulted in a crop of crystals whose weight was greater than the theoretical

amount calculated from the equilibrium diagram constructed from van Klooster's data at 25°C. and containing appreciable amounts of magnesium sulphate. Either long-continued stirring was required to again bring the magnesium sulphate into solution, or a slow rate of cooling with stirring between 50-35°C. in order to obtain the theoretical amount of pure potassium sulphate was necessary. These experiments and those of Weston emphasize the important part played by rates of crystallization in solubility determinations.

Work on this system at 85°C. has been undertaken, and it is also intended to study the system at 100°C.

The authors wish to acknowledge the helpful suggestions and criticisms of Dr. H. H. Storch during the progress of this work, and their appreciation of the cooperation of Professor P. A. Van der Meulen, of the Chemistry Department of Rutgers University.

#### Summary

The solubility relations of the system potassium sulphate, magnesium sulphate, and water at 30° have been measured. Potassium sulphate, schönite, and magnesium sulphate heptahydrate have been shown to be the stable phases at this temperature. The existence of mixed crystals reported by a previous investigator has been disproved.

## THE SYSTEM: $\text{CuSO}_4\text{-H}_2\text{SO}_4\text{-H}_2\text{O}$

H. D. CROCKFORD AND L. E. WARRICK\*

The first systematic study of the system,  $\text{CuO-SO}_3\text{-H}_2\text{O}$  was made by Bell and Tabor,<sup>1</sup> who determined the 25°C isotherm. Later Foote,<sup>2</sup> evidently unaware of the work of Bell and Tabor, determined the same isotherm. His results check fairly well with those of Bell and Tabor except at certain of the quadruple points where the discrepancy is greater than the experimental error. Agde and Barkholt,<sup>3</sup> have determined a number of points in the system by the cooling curve method. However, due to the narrow acid range used and the inaccuracy of the procedure their results have little theoretical value. Cameron and Crockford,<sup>4</sup> have determined a limited number of points on the 30°C isotherm. In this paper are given the results of a study of the 0°, 20°, 40°, and 55°C isotherms thruout the acid range of the system. Since the start of this work Posnjak and Tunell,<sup>5</sup> have published the data for the 50°, 100°, and 200°C isotherms. A discussion of the methods and data of the various investigators is given later in the paper.

### Experimental Procedure

Starting solutions were prepared from C.P. grade of cupric sulphate and sulphuric acid, and distilled water. A series of bottles containing approximately 100 cc of saturated solution were prepared covering the ranges to be studied. For the 20°, 40°, and 55°C isotherms the bottles were placed in a constant temperature bath accurate to + or - .05°C. The 0°C isotherm was obtained by placing the bottles in a large container packed with finely ground ice and filled with water. The temperature varied within the range of .3° to approximately 0°C. The bottles were shaken by hand twice a day and the solid phase broken up with a glass stirring rod.

Copper was determined by electrolytic precipitation and sulphates were determined by precipitation with barium chloride.

The composition of solid in equilibrium with the various solutions was determined graphically by means of intersecting tie lines, the solid phases being analyzed without any attempt being made to remove the adhering solution other than by drainage. Solid phases were removed from their bottles by means of a glass spoon. It was not considered necessary to analyze all solid phases along smooth curves.

The results are given in weight percent of  $\text{CuO}$ ,  $\text{SO}_3$ , and  $\text{H}_2\text{O}$ .

\* Contributed from the Chemistry Laboratory of the University of North Carolina.

<sup>1</sup> J. M. Bell and W. C. Tabor: *J. Phys. Chem.*, **12**, 171 (1908).

<sup>2</sup> H. W. Foote: *J. Am. Chem. Soc.*, **37**, 288 (1915).

<sup>3</sup> G. Agde and H. Barkholt: *Z. angew. Chem.*, **40**, 374 (1927).

<sup>4</sup> F. K. Cameron and H. D. Crockford: *J. Phys. Chem.*, **33**, 709 (1929).

<sup>5</sup> E. Posnjak and G. Tunell: *Am. J. Sci.*, **18**, 1 (1929).

## Results and Discussion

The data for the four isotherms studied are given in Tables I-IV and the results are plotted in Figs. 1-4.

TABLE I  
°C Isotherm

Sample No.	Liquid Phase		Solid Phase		Composition of Solid
	%CuO	%SO <sub>3</sub>	%CuO	%SO <sub>3</sub>	
1	7.34	7.40	24.74	25.74	$\text{CuSO}_4 \cdot 5\text{H}_2\text{O}$
2	3.14	14.55	—	—	"
3	1.50	21.23	—	—	"
4	1.18	23.52	—	—	"
5	.15	34.60	27.59	32.51	"
6	.30	41.07	18.09	36.24	"
7	.59	43.39	19.04	39.69	$\text{CuSO}_4 \cdot 5\text{H}_2\text{O}$ and $\text{CuSO}_4 \cdot 3\text{H}_2\text{O}$
8	.47	47.44	18.74	42.10	$\text{CuSO}_4 \cdot 3\text{H}_2\text{O}$
9	.09	48.54	9.23	48.87	$\text{CuSO}_4 \cdot \text{H}_2\text{O}$
10	.14	50.76	—	—	"
11	.13	54.07	25.15	49.05	"
12	.05	65.52	—	—	"
13	.09	71.93	—	—	"
14	—	73.57	19.77	61.06	"
15	.02	73.58	24.25	58.86	$\text{CuSO}_4 \cdot \text{H}_2\text{O}$ and $\text{CuSO}_4$

It is seen that the solubility of the various solid phases decrease with increasing sulphuric acid and decreasing temperature. The curves given, as well as those determined by other investigators all have the same general shape. The solid phases consist of the pentahydrate, trihydrate, monohydrate, and anhydrous copper sulphate. These solid phases were found by the other investigators cited in the ranges studied except in the case of Posnjak and Tunell (*loc. cit.*) who found that the pentahydrate did not exist at 100°C and neither the pentahydrate nor the trihydrate at 200°C.

In our case it was found necessary to allow about seven days for equilibrium. Foote (*loc. cit.*), who also prepared his solutions from copper sulphate and sulphuric acid, stated that only twenty-four hours was necessary for equilibrium to be established. However his solutions were subjected to constant shaking. Bell and Tabor (*loc. cit.*), in their solutions employing the pentahydrate as a starting material, allowed their solutions to remain two weeks before analyzing. Posnjak and Tunell (*loc. cit.*) found that months were required before equilibrium was established when copper oxide was used as a starting material. These investigators carried out their determinations in sealed tubes.

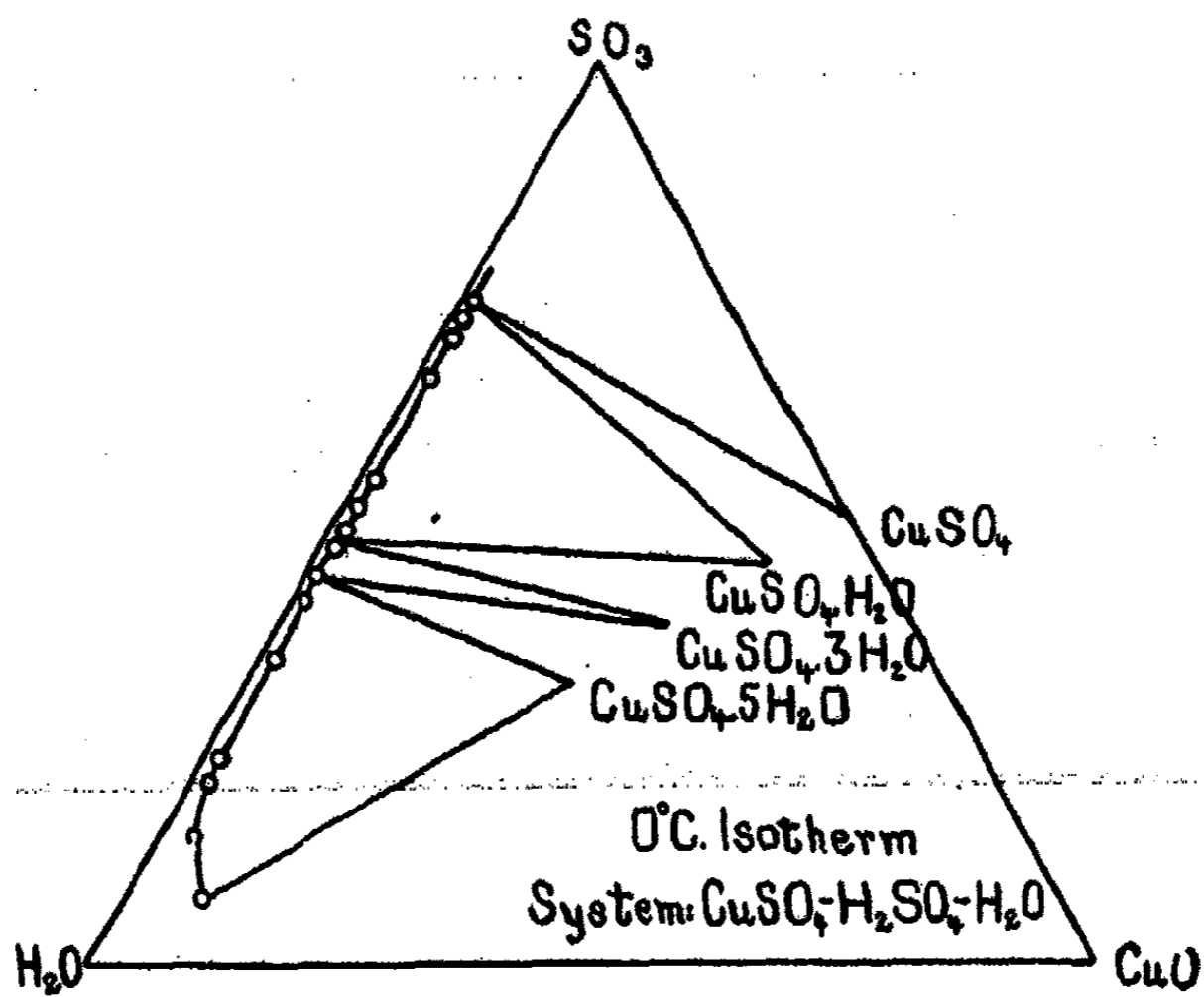

FIG. 1

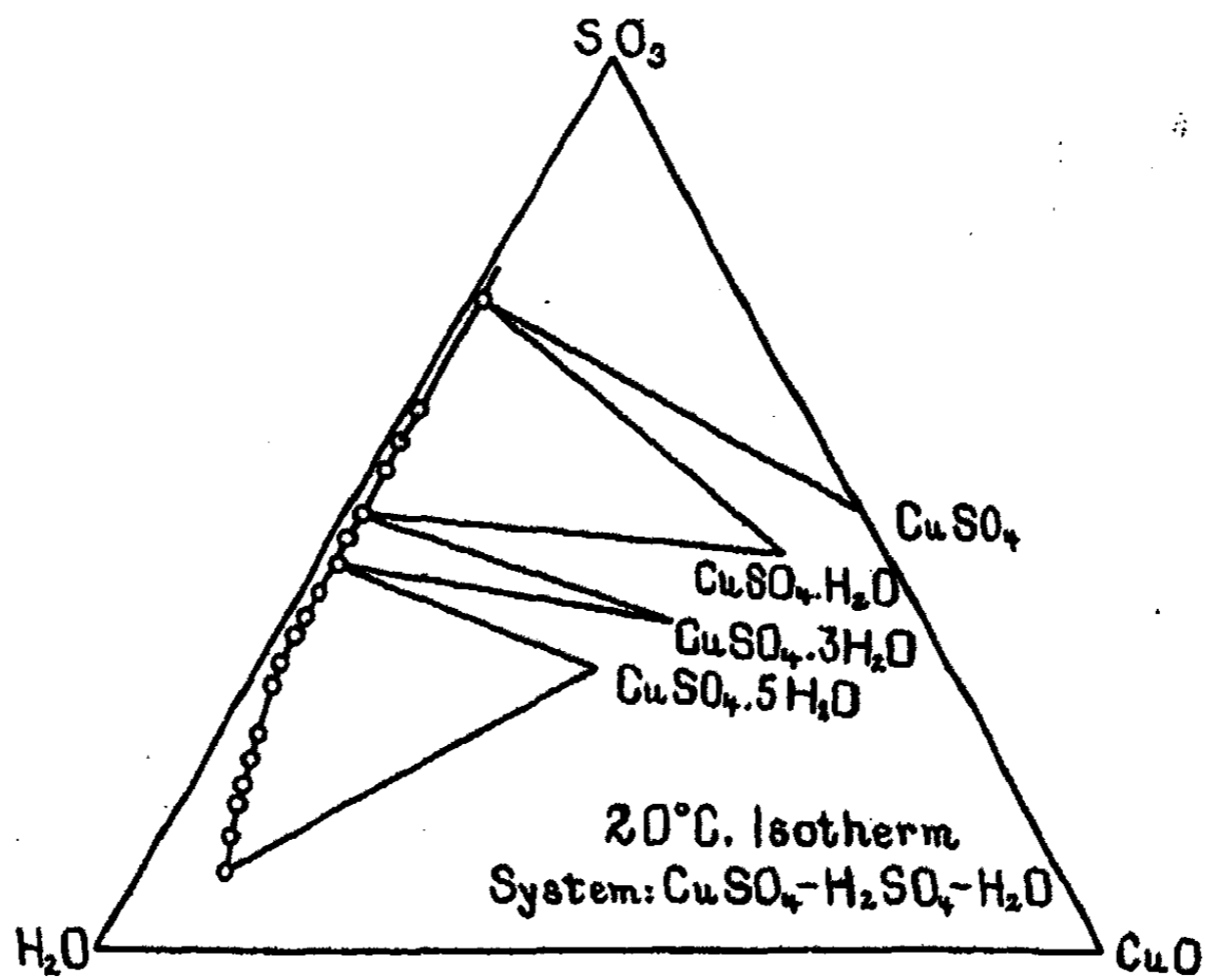

FIG. 2

TABLE II  
20°C Isotherm

Sample No.	Liquid Phase		Solid Phase		Composition of Solid
	%CuO	% $\text{SO}_3$	%CuO	% $\text{SO}_3$	
1	8.43	8.89	27.36	27.82	$\text{CuSO}_4 \cdot 5\text{H}_2\text{O}$
2	7.06	12.24	26.95	28.88	"
3	5.43	16.08	26.59	29.40	"
4	4.51	18.49	30.80	30.33	"
5	3.97	21.03	26.76	30.54	"
6	2.93	24.01	28.11	31.51	"
7	1.68	29.32	26.12	31.58	"
8	1.38	32.22	25.64	32.41	"
9	1.25	35.84	27.01	32.69	"
10	1.03	37.61	26.38	33.42	"
11	1.26	40.15	24.23	34.63	"
12	1.04	43.11	23.08	39.06	$\text{CuSO}_4 \cdot 5\text{H}_2\text{O}$ and $\text{CuSO}_4 \cdot 3\text{H}_2\text{O}$
13	.23	45.32	25.47	40.24	$\text{CuSO}_4 \cdot 3\text{H}_2\text{O}$
14	.71	48.44	22.81	43.03	$\text{CuSO}_4 \cdot 3\text{H}_2\text{O}$ and $\text{CuSO}_4 \cdot \text{H}_2\text{O}$
15	.18	53.42	23.28	48.81	$\text{CuSO}_4 \cdot \text{H}_2\text{O}$
16	.08	57.10	21.91	50.96	"
17	.05	60.17	22.68	52.55	"
18	.09	72.19	23.09	61.00	$\text{CuSO}_4 \cdot \text{H}_2\text{O}$ and $\text{CuSO}_4$

TABLE III  
40°C Isotherm

Sample No.	Liquid Phase		Solid Phase		Composition of Solid
	%CuO	% $\text{SO}_3$	%CuO	% $\text{SO}_3$	
1	10.21	10.34	26.56	27.12	$\text{CuSO}_4 \cdot 5\text{H}_2\text{O}$
2	8.63	13.37	27.54	29.55	"
3	6.91	17.09	27.52	29.74	"
4	5.65	21.69	27.64	31.54	"
5	4.03	26.05	26.47	31.31	"
6	2.75	31.95	27.54	32.28	"
7	2.09	36.84	25.92	31.72	"
8	2.19	38.78	23.12	38.44	$\text{CuSO}_4 \cdot 3\text{H}_2\text{O}$
9	1.98	42.35	—	—	"
10	1.56	47.09	22.33	42.49	"
11	.87	48.64	22.37	46.63	$\text{CuSO}_4 \cdot \text{H}_2\text{O}$
12	.26	53.12	—	—	"
13	.10	59.64	21.98	51.94	"
14	.18	68.88	24.44	55.63	"
15	.33	70.25	26.66	58.88	$\text{CuSO}_4 \cdot \text{H}_2\text{O}$ and $\text{CuSO}_4$
16	.14	74.37	26.81	61.02	$\text{CuSO}_4$

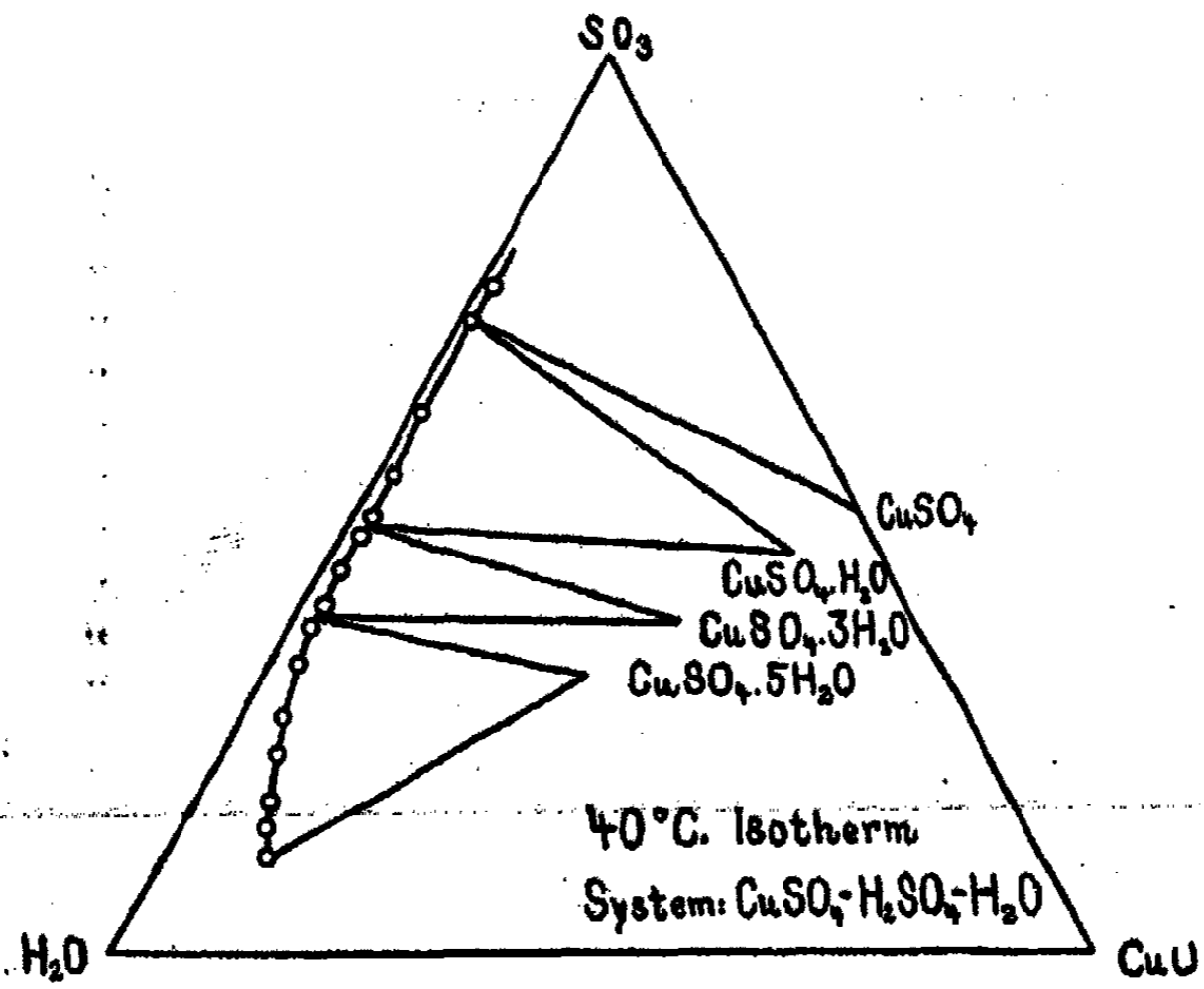

FIG. 3

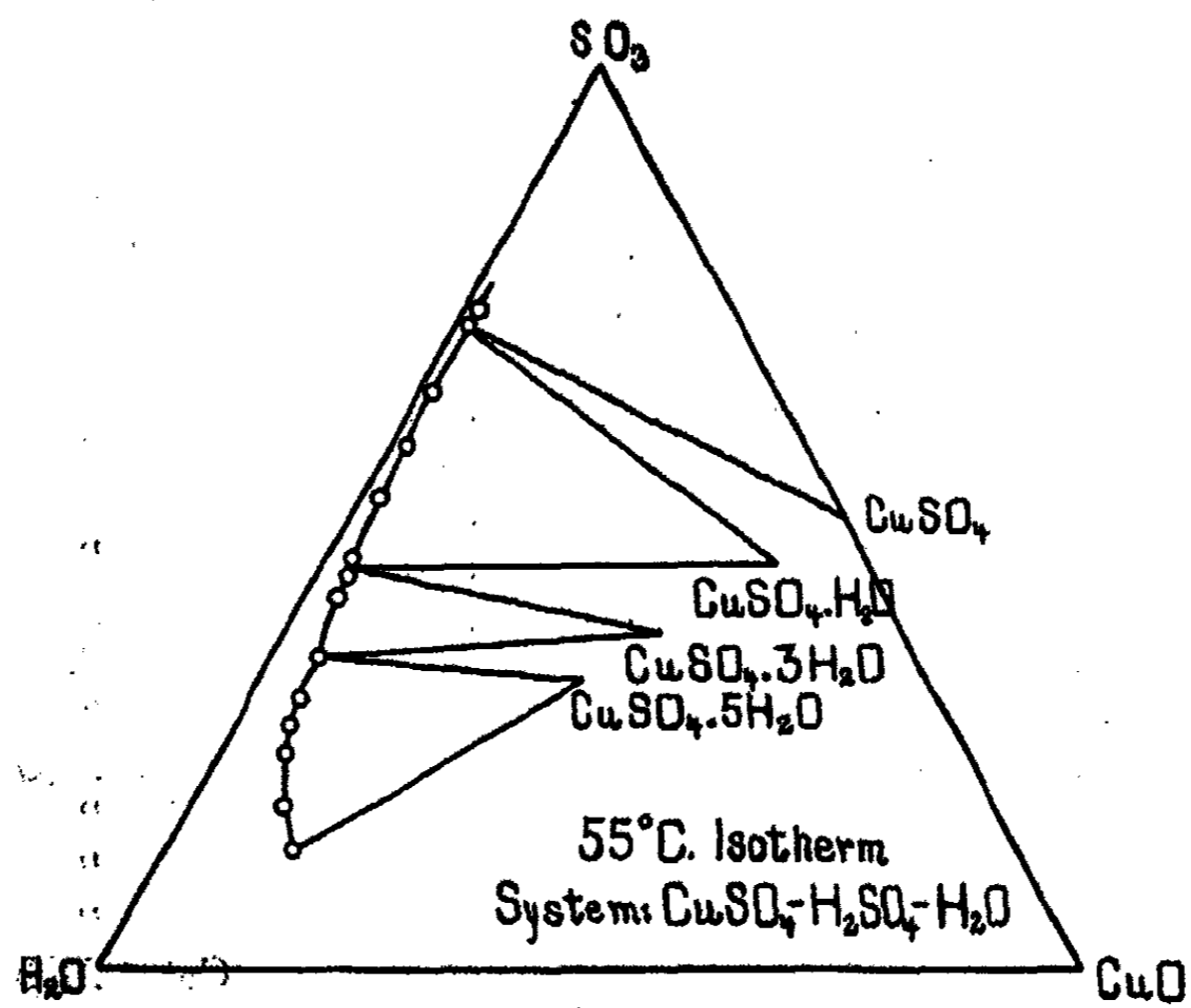

FIG. 4



TABLE IV  
55°C Isotherm

Sample No.	Liquid Phase		Solid Phase		Composition of Solid
	%CuO	% $\text{SO}_3$	%CuO	% $\text{SO}_3$	
1	13.16	13.41	25.86	26.37	$\text{CuSO}_4 \cdot 5\text{H}_2\text{O}$
2	9.88	17.82	—	—	"
3	6.07	24.45	—	—	"
4	5.74	27.58	—	—	"
5	5.75	29.82	21.32	31.34	"
6	5.05	34.42	29.96	33.07	$\text{CuSO}_4 \cdot 5\text{H}_2\text{O}$ and $\text{CuSO}_4 \cdot 3\text{H}_2\text{O}$
7	3.45	40.62	—	—	$\text{CuSO}_4 \cdot 3\text{H}_2\text{O}$
8	2.98	42.69	27.52	39.86	"
9	1.85	45.04	18.15	44.61	$\text{CuSO}_4 \cdot \text{H}_2\text{O}$
10	.55	52.39	—	—	"
11	.24	57.65	—	—	"
12	.08	64.16	—	—	"
13	.22	71.89	25.54	60.40	$\text{CuSO}_4 \cdot \text{H}_2\text{O}$ and $\text{CuSO}_4$
14	.08	72.62	36.20	56.07	$\text{CuSO}_4$

In Table V are given the percentages of sulphuric acid in the various solutions at the quadruple points. In certain cases the actual four-phase system has been realized whereas in others the percentage had to be calculated from inspection of the curves.

TABLE V

Percentage of Sulphuric Acid in Solutions at the Various Quadruple Points

Investigator	Temperature C	$\text{CuSO}_4 \cdot 5\text{H}_2\text{O}$ - $\text{CuSO}_4 \cdot 3\text{H}_2\text{O}$	$\text{CuSO}_4 \cdot 3\text{H}_2\text{O}$ - $\text{CuSO}_4 \cdot \text{H}_2\text{O}$	$\text{CuSO}_4 \cdot \text{H}_2\text{O}$ - $\text{CuSO}_4$
Crockford-Warrick	0°	52.43	58.46*	90.11
Crockford-Warrick	20°	51.53	58.47	88.32
Foote	25°	49.16	55.72	85.76
Bell-Tabor	25°	49.00*	58.43	88.51-90.89
Crockford-Warrick	40°	43.49*	56.35*	85.65
Posnjak-Tunell	50°	41.65*	46.45*	88.49*
Crockford-Warrick	55°	35.98	49.00*	87.79
Posnjak-Tunell	100°	—	23.03	86.24*
Posnjak-Tunell	200°	—	—	79.62*

\* Estimated.

It is seen that the percentage of sulphuric acid at the transition point for the pentahydrate and trihydrate shows a regular decrease with increasing temperature. For the trihydrate-monohydrate and the monohydrate-anhy-

drous copper sulphate transition point the data are not so regular. Our values at 20°C and 40°C for these two points would indicate that the data of Bell and Tabor at 25°C is much more exact than that of Foote at the same temperature. The general conclusion can be drawn that as the temperature increases the percentage of sulphuric acid at the transition point decreases.

#### Summary

The 0°, 20°, 40°, and 55°C isotherms for the system:  $\text{CuSO}_4\text{-H}_2\text{SO}_4\text{-H}_2\text{O}$  have been determined.

The data obtained agree in a general way with that of other investigators and shows that the solubility of copper sulphate is depressed by increasing the percentage of sulphuric acid and increased by raising the temperature.

A study of the transition points obtained by the various investigators shows that increasing temperature results in the transition taking place at a lower concentration of sulphuric acid.

## PHYSICO-CHEMICAL STUDIES ON PROTEINS. IV

### A Comparative Study of the Acid and Alkali Binding of Native and Deaminized Proteins\*

BY WILLIAM MARTIN SANDSTROM

#### I. Introduction

In order to make a comparative study of the acid- and base-binding capacities of a variety of proteins it was thought desirable in this laboratory to prepare several representative members of each class under as uniform conditions as possible and to submit them to chemical analysis together with the physico-chemical measurements. The first paper in this series (Hoffman and Gortner (17)) dealt with twelve prolamines from the wheat and the maize groups; with casein and fibrin for purposes of comparison. This paper represents a similar study of some typical globulins and several deaminized proteins.

#### II. Historical

*The binding of acid and alkali by proteins.* It has been known for the past sixty years that the proteins are amphoteric. During that period many measurements have been made of their capacity to take up acid or alkali from solution. The literature is too voluminous to review in detail here but excellent summaries are given by Robertson (42), Cohn (5), and Hoffman and Gortner (17).

The earlier work was done with such chemical means as were available. Proteins were titrated with dilute acid or alkali to neutrality as determined by indicators. This method has two disadvantages: the end-points are not very distinct and only the binding at the hydrogen ion concentration of the indicator change can be measured. Thus one gram of casein neutralized  $55 \times 10^{-5}$  equivalents of alkali using litmus as an indicator (60) but required  $90 \times 10^{-5}$  equivalents with phenolphthalein.

Attempts were also made to precipitate or coagulate the "protein salts" with alcohol or other precipitants. However, it has since been shown by Robertson (46) that the coagulation of the alkaline caseinates through the addition of alcohol to the system is preceded by a decrease in the degree of dissociation of the protein complex. He also pointed out (Robertson (45)), that by using the potentiometric method (a static method) twice as much alkali was bound per gram of casein as that calculated by Spiro and Pemsel (55) from experiments where ammonium sulfate was used to precipitate the sodium caseinate.

\* Published with the approval of the Director as Paper No. 858, Journal Series, Minnesota Agricultural Experiment Station. This paper is a report of work carried out under the Minnesota Agricultural Experiment Station Project on "The Chemistry of the Proteins" under the leadership of Ross Aiken Gortner. Division of Agricultural Biochemistry, Minnesota Agricultural Experiment Station.

Solubility methods have also been used. Some of the older work reports the combination in terms of the amount of acid or alkali bound when the acid or alkali is "saturated" with the protein. Such values are obtained when an excess of the insoluble protein is added to the aqueous system. Thus Robertson, (45) found that one gram of casein required  $32 \times 10^{-5}$  equivalents of hydrochloric acid, and  $11.5 \times 10^{-5}$  of alkali. Hoffman and Gortner (17) list over thirty values obtained by various workers on the more common proteins, but the values reported from various laboratories do not agree very well.

More reliable information has been obtained from physicochemical studies because the measurements depend upon static methods and a wider range of hydrogen ion concentrations can be included. The cryoscopic method has been used by Bugarzsky and Liebermann (4), and Takeda (56), but it is to be recalled that such values were obtained at about 0°C. and that the temperature coefficients are of considerable magnitude especially at higher concentrations of acid and alkali (17). Bugarzsky and Liebermann (4) found that 6.4 grams of egg albumin added to 100 cubic centimeters of 0.05 normal hydrochloric acid or sodium hydroxide decreased the value of  $\Delta$  by 50 per cent indicating that the total number of ions and molecules in the system had been decreased one half. They could detect no effect of their protein on neutral salt solutions. The freezing point method has not been widely used, probably because it is not sufficiently sensitive and has been supplanted by electrical methods. The same may be said for the measurements of the concentration of hydrogen ions by their catalytic effect on the rate of inversion of sucrose.

Measurements of electrical conductivity have been made on acid or alkali solutions to which proteins were added. The method depends upon the fact that protein salts are apparently less highly ionized than are the equivalent concentrations of acids and alkalis, and that the ions have a low migration velocity because of their mass and volume. Hardy (10) used this method, as did Mellanby (31) and Robertson (47).

Probably the potentiometric method has been most widely used. A large number of measurements have been made of the concentration of hydrogen ions and of chloride ions in protein systems. Bugarzsky and Liebermann (4) measured the electromotive force between hydrogen electrodes immersed in a cell containing 0.05 normal hydrochloric acid and in one containing the same concentration of acid with varying amounts of egg albumin. They showed that the protein bound a part of the acid and obtained similar results on the alkaline side but could detect no binding of sodium chloride. They also pointed out that the fraction of acid or alkali bound was lowered as the concentration increased.

Blasel and Matula (2) used the formula:  $n = N - \frac{C_{H^+}}{\alpha}$ ; where  $n$  is the amount of acid bound;  $N$ , the original normality;  $C_{H^+}$ , the determined hydrogen ion concentration at equilibrium; and  $\alpha$ , the dissociation constant from specific conductivity data. Hoffman and Gortner (17) pointed out that the  $\alpha$  used must be determined by potentiometric methods because the former

method gives lower values particularly on the alkaline side. Lloyd and Mays (28) consider that the quantity,  $\sqrt{(H^+)(Cl^-)}$  gives a better value than the  $(H^+)$  in the equation of Blasel and Matula (2). They determined the value of  $(H^+)$  in the usual way, and calculated that the value of  $(Cl^-)$  by assuming that the gelatin chloride was completely ionized.

Chloride ion measurements have been made using a chlorine electrode. Working at concentrations below 0.05 normal, Bugarzsky and Liebermann (4) showed that almost as many chloride as hydrogen ions were bound. Manabe and Matula (29), Oryng and Pauli (34), and Hitchcock (16) have used the chlorine electrode in their studies. In general, it is found that at the lower concentrations of hydrochloric acid less chloride than hydrogen ions are bound and the difference, which they interpret as ionization of gelatin chloride, reaches a maximum at 0.02 normal hydrochloric acid. After that it drops, until at 0.05 normal ionization is completely suppressed and the two ions are bound in equivalent quantities.

*Nature of the binding of acid and alkali.* There are two schools of thought on the interpretation of the data in the literature. One group believes that the proteins bind acids and alkali stoichiometrically, that is, the primary valences of the basic groups neutralize the acid, yielding compounds analogous to ammonium salts. The other view explains the binding as an adsorption phenomenon following the empirical adsorption isotherm of Freundlich:

$$x = aC^{1/n}$$

Evidence for chemical binding is based on the correlation between the amounts of acid bound and the basic groupings of the protein molecule, such as the  $\epsilon$ -amino group of lysine, the guanidine nucleus of arginine, and possibly the imino group of the imidazole ring in histidine. Robertson (47, p. 208) believes that the peptide linkage functions in both acid and base binding. In the former case probably the keto form acts thus:

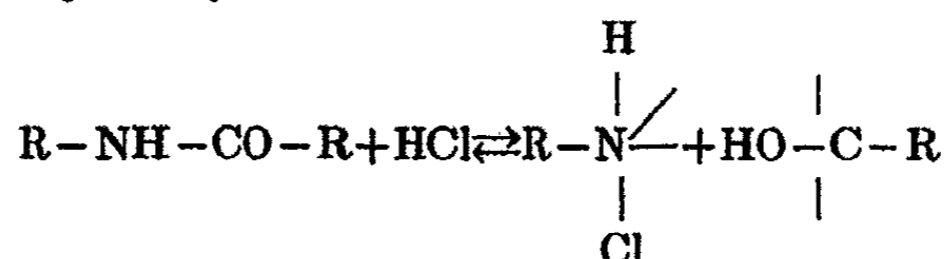

giving rise to two bulky protein ions. His postulate is based on the fact that, when one equivalent of acid is added and the solution electrolyzed, protein ions are found in both the anode and the cathode compartments. He later showed (48) that casein and gelatin when hydrolyzed by enzymes require less acid to bring the system to a pH of 2.0 than do the unhydrolyzed proteins. Therefore he argues that the basic groups do not bind the acid. He has forgotten the fact that hydrolysis also liberates acid groupings which will alter the buffer value of the system. His theory does not account for the fact that at low concentrations of acid added, the anions and cations are not bound in equivalent quantities.

In the chemical theory of alkali binding the quantity bound is correlated with the functional acidic groups present, according to the equation: dicarboxylic acid + OH group of tyrosine - amide nitrogen = base-binding equivalents.

Robertson believes that, as in the case with acids, the peptide linkage functions here but in the enolic form:

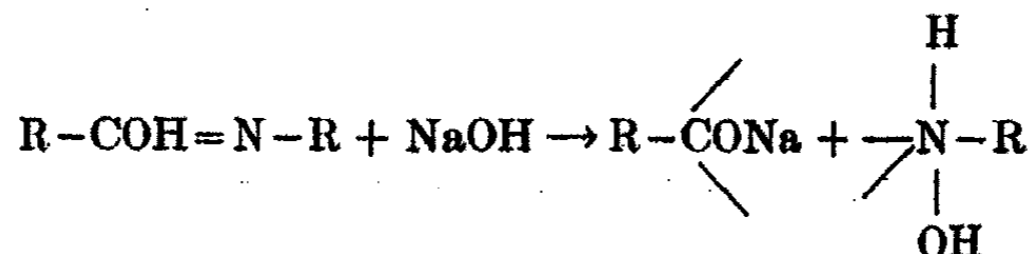

It is to be noted that none of the data supporting the theory of chemical binding extend beyond a pH 2.5 or 3.0 on the acid side and a pH of 11.0 in the basic range. Excellent summaries of the data leading to these conclusions are given by Hoffman and Gortner (17), and Cohn (5).

Workers who have extended the measurements beyond the field of the range of chemical binding are at a loss to account for the amounts of acid or alkali taken up by the proteins on the basis of primary valences. If the equivalents bound per gram of protein be plotted against either the initial concentrations of electrolyte or the equilibrium concentrations, curves very similar to adsorption isotherms result. Or better still, if the logarithms of the coordinates are used, straight lines result. Furthermore, these lines are very similar in spite of great differences in the chemical composition of the proteins. Hoffman and Gortner (17) also found a negative temperature coefficient between isotherms for 15°, 25°, and 35°, a fact which argues for adsorption in the ranges of hydrogen ion concentrations beyond pH = 2.5 and 10.5.

There are scattered references to the effect of other electrolytes on the acid- and base-binding capacities. Manabe and Matula (29) report that neutral salts caused a 2 to 3 per cent increase in the hydrogen ions bound by albumin and gelatin; also Blasel and Matula (2) found that salts increased the binding on both sides of neutrality. Oryng and Pauli (34) reported similar changes, and made the observation that both KCl and H<sub>2</sub>SO<sub>4</sub> "considerably increased the chloride ions bound by serum in hydrochloric acid".

Csapo (6) repeated the work and found that sodium chloride, sodium iodide, and sodium nitrate increased by ten per cent the binding capacity of gelatin for hydrochloric, nitric, and sulfuric acids, while sodium sulfate depressed the binding 50 per cent. The series, K < Na < Ba < Ca, is reported for the cations. The author concludes that the effects are not due to common ion effects. The results produced suggest the typical Hofmeister series of ions affecting the imbibition of water by gelatin.

*The binding of acid and alkali by globulins.* Edestin, serum globulin and the Bence-Jones protein are the only globulins which have been studied. Osborne (36) pointed out the basic characteristic of edestin from which he was able to prepare two hydrochlorides. The one was soluble in water, the other insoluble; when titrated with standard alkali, using phenolphthalein

as an indicator, the former was found to require twice as much base as the second. He therefore considered the one edestin dihydrochloride, and the other the monohydrochloride.

Hardy (10) measured the quantity of various acids needed to dissolve one gram of serum globulin. He found that an average of  $18 \times 10^{-6}$  equivalents of the strong monobasic acids were required, twice that amount of sulfuric, tartaric, or oxalic acids were needed, and three times as much citric or phosphoric acid. From this he concluded that at saturation serum globulin combined in molecular rather than equivalent proportions. He did not measure the hydrogen ion concentration at equilibrium, but in the light of later work by Sørensen and others, probably all the acids ionized as monobasic compounds and he had reached the same degree of acidity in each case. Similarly, he found that mono-acid bases were bound by the protein at "saturation" to the extent of  $10 \times 10^{-6}$  gram equivalents, and the di-acid bases approximately twice as much.

Robertson (43, 44) repeated the work, using potentiometric methods to determine the hydrogen or hydroxyl ion concentrations of the equilibrium mixtures, and found that the acid equivalent increased with increasing acidity of the solution but that this was not so regular as on the alkaline side.

Hitchcock (13) showed that 0.45 grams edestin bound 5.6 cubic centimeters of 0.01 normal hydrochloric acid at a pH = 2.1 and an equivalent quantity of  $H_2SO_4$ , while oxalic and phosphoric acids were bound in the ratio of 1.9 and 3.2, respectively. In a later paper (15) he calculated the binding capacity of edestin for hydrochloric acid in a different way. His curve of hydrogen ions bound is plotted as the "total globulin chloride" and the curve showing the excess of free chloride ions over hydrogen ions is labeled "ionized globulin chloride". No measurements were made beyond an equilibrium pH = 1.1. He found the first curve to be nearly flat beyond a pH = 1.4 at which point the ionized salt had reached a maximum. From then on, the ionization dropped off very sharply.

Similar curves were drawn from the data on serum globulin but the conclusions arrived at were based on very scattered readings beyond a pH of 2.2 (p. 391). An earlier paper (14) reported the behavior of ox serum globulin with two alkalis, sodium hydroxide and barium hydroxide. A titration curve is given showing that the globulin binds equivalent quantities of either base, which he interprets as evidence of stoichiometrical binding. However, beyond a pH of 10 the data appear to us very much like those of a typical adsorption isotherm. Manabe and Matula (29) had earlier reported data of a very similar nature.

The isoelectric point of edestin is reported at  $1.3 \times 10^{-7}$  N from a study of maximum precipitation in a phosphate buffer mixture (49). Later Michaelis and Mendelssohn (32) found the value of  $2.5 \times 10^{-6}$  N with acetate buffers. Hitchcock (14) also noted that the point of maximum precipitation varied with the buffer used.

*The binding of acid and alkali by deaminized proteins.* Blasel and Matula (2) showed that deaminized gelatin bound hydrogen ions to the extent of one half of that of the untreated gelatin. Hitchcock (16) repeated the work and showed that the acid equivalent of gelatin dropped from 8.9 to  $4.0 \times 10^{-5}$  when the protein was deaminized with nitrous acid. At the same time the protein lost  $4.0 \times 10^{-5}$  equivalents of amino nitrogen. Pauli and Hirschfeld (37) compared gelatin with its deaminized product, as did Blasel and Matula (2) who found that fewer hydrogen ions were bound by the treated product. On the alkaline side they found at the lower concentrations almost complete binding of the hydroxyl ion by all their proteins, with a constant increase of binding with increased addition of base.

*The isolation and analysis of globulins.* The globulins are defined as those naturally occurring proteins insoluble in water but soluble in neutral salt solutions. They are in general precipitated on dilution, on removal of the salts present by dialysis, and on complete saturation with magnesium sulfate, or by half saturation with ammonium sulfate. Like the albumins, the globulins are irreversibly heat-coagulable. Some well known members of animal origin are fibrinogen, serumglobulin, ovoglobulin and lactoglobulin. Serum globulin is often separated into two fractions; a smaller quantity, the euglobulin, precipitates out on diluting or dialyzing serum; but the major portion, pseudoglobulin, only precipitates when to the diluted serum is added an equal volume of saturated ammonium sulfate solution. No differences in the amino acid content on hydrolysis of the two fractions can be detected, but the euglobulin generally contains more phosphorus. In plants the globulins constitute a large part of the proteins of the seeds. Excelsin from the brazil nut, edestin from hemp seed, vicilin of the pea, arachin from the peanut, and glycinin from the soy bean are typical examples. Globulins as a group contain no amino acids in unusually large quantities with the exception of arginine which may constitute twenty per cent of the total nitrogen. They usually run fairly high in the dicarboxylic acids, largely glutamic acid, and the amide nitrogen is higher than the average of the proteins in general, but less than that of the prolamines.

Edestin was first prepared by Ritthausen (41) from hempseed, *Cannabis sativa*, using an alkaline extraction. Osborne (35) pointed out that the protein may be altered in the process and preferred to extract the fat-free meal with ten per cent sodium chloride. He removed the salt by dialysis and recrystallized the precipitate from warm 10 per cent sodium chloride in the ice box. This gives a fair yield of crystalline edestin and has become sufficiently standardized to be used in students' laboratory manuals. Reeves (39) used 0.5 normal sodium benzoate for the first extraction; for Schryver (52) had shown that at that concentration the surface tension of aqueous sodium benzoate was the lowest and the solution had the maximum peptizing action on edestin.

Mathews (30, p. 129) lists the following amino acids isolated from a hydrochloric acid hydrolysate, representing a 82.38 per cent recovery:



glycine	3.80	serine	0.53
alanine	3.60	cystine	1.00
valine	6.20	tyrosine	2.13
leucine	14.50	arginine	14.17
proline	4.10	histidine	2.19
phenylalanine	3.09	lysine	1.65
aspartic acid	4.50	ammonia	2.28
glutamic acid	18.84	tryptophane	+

Van Slyke (58) determined the nitrogen distribution which is compared with our analysis (Table I). More recently Schryver and his co-workers (53) have isolated from edestin  $\beta$ -hydroxylysine to the extent of 3.28 per cent of the total nitrogen. This should precipitate in the bases and would be calculated as lysine. Sakaguchi (50) believes that the guanidine nucleus of arginine is free in edestin since, by his colorimetric method, he obtained the same values in the hydrolysate as in the native protein. Hunter (19), on the other hand, finds that only one-half of the guanidine nucleus is attacked by arginase and so concludes that only that fraction is uncombined in edestin.

Ritthausen (40) first extracted a globulin from unroasted peanuts, *Arachis hypogaea*. Johns and Jones (20) repeated his work and separated the globulin into two fractions, arachin and conarachin, by fractional precipitation of the 10 per cent sodium chloride extract with ammonium sulfate. Arachin occurs in the larger quantity. In a later paper (21) they report the nitrogen distribution by the Van Slyke analysis.

The globulin of the cantaloupe seed, *Cucumis melo*, was first isolated by Jones and Gersdorff (22). They found it very similar to the squash seed globulin isolated according to the method of Osborne (35), as to nitrogen distribution, and identical immunologically.

*The preparation and analysis of deaminized proteins.* Skraup and Levites were the first to make any extensive studies on the reaction between nitrous acid and proteins. Levites (25) obtained an olive-green product by making a paste of sodium nitrite and the protein and then adding dilute acetic acid and warming. Skraup and Hoernes (54) preferred to dissolve or suspend the protein in dilute acetic acid, add sodium nitrite, and warm. They report an average yield of 70 per cent on a number of preparations. In this way they prepared deaminized casein; the same method was used by Traxl (57) to obtain deaminized edestin. Gelatin, albumin, and serum globulin were also deaminized in Skraup's laboratory. Levites (25, 26) deaminized egg albumin, gelatin, casein, gliadin, and vitellin.

Dunn and Lewis (7) made a study of the factors which influence the yield, and modified Skraup's method mainly in that by allowing the mixture to stand at room temperature for 18 hours they were able to obtain better yields and a more uniform product. They found that the insoluble product which settled out soon after adding the sodium nitrite was not completely deaminized but that 18 hours at a low temperature would allow the reaction to go to completion. Hitchcock (16) observed that only the free amino groups were

removed when the nitrous acid treatment was carried out at room temperature but that 100 per cent more nitrogen was lost when the reacting mixture was warmed. The preparations of Dunn and Lewis were yellow when freshly precipitated but turned brown on exposure to air. The material gave no free amino nitrogen in the Van Slyke apparatus. The biuret test was weaker than in the original casein, but the Hopkins-Cole test was not affected. These workers also verified Levites' (25) observation that Millon's test was positive altho somewhat weaker than in the untreated protein. Since Dunn and Lewis could isolate somewhat less tyrosine from the hydrolysate of the deaminized product and since quantitative measurements showed that approximately 50 per cent of the material responsible for the phenolic test remained, they concluded that tyrosine was not completely destroyed or altered by nitrous acid. Levites (26) had reported that the same quantity of all the mono-amino acids could be isolated from a deaminized protein as from the untreated protein, with the one exception of tyrosine which he was unable to isolate from any hydrolysate of deaminized proteins.

From a nitrogen distribution by Van Slyke's method Dunn and Lewis showed that practically all the lysine, half of the histidine, but none of the arginine is lost in the nitrous acid treatment. The filtrate from the bases gained proportionately in amino nitrogen. Their work confirms the theory that the  $\epsilon$ -group of lysine is free in casein, and that this amino acid is converted by nitrous acid to the corresponding  $\epsilon$ -hydroxy compound. However, this latter compound has never been isolated from the filtrate. Dunn and Lewis believe that the difference in histidine values is accidental since this amino acid is calculated by differences. Lampl (24) showed that arginine was unaltered, histidine only partially altered, and lysine completely changed, in deaminized serum globulin.

That the method of Dunn and Lewis does not radically alter the protein structure is indicated by the fact that enzymes hydrolyze deaminized casein in vitro, altho at a slower rate than casein (8). Similar results were obtained by Nakashima (33).

#### Experimental

*The preparation and analysis of the proteins used.* Edestin, arachin, and the cantaloupe seed globulin were selected as three proteins typical of their class and capable of being prepared in sufficient quantities for study. The two first mentioned were deaminized together with three of the proteins studied by Hoffman and Gortner (17). Durumin is a typical prolamine; casein and fibrin have been widely studied both in this laboratory and elsewhere. Of the eight proteins studied, deaminized durumin and deaminized fibrin have never been mentioned in the literature, none of the deaminized proteins except casein has ever been analyzed by the Van Slyke method, and data on the acid- and base-binding capacity of edestin only could be found.

The proteins were prepared according to the procedures given below. Ash, moisture, total nitrogen, and amino-nitrogen by the Van Slyke apparatus were determined in the usual way. In the Kjeldahl digestion, mercuric oxide was used as the catalyst and the mercury precipitated as its sulfide before

distillation. In a few cases the distillate was found to be sufficiently milky to make the end-point with sodium alizarin sulfonate difficult to determine. The distillate was then returned to Kjeldahl flask, made alkaline, and the ammonia redistilled into fresh standard acid.

For the nitrogen distribution 3 grams of protein were hydrolyzed 24 hours with constant-boiling hydrochloric acid. Van Slyke's (58) method was followed with the modifications used by Gortner and Sandstrom (9) except that no corrections were made for the solubility of the phosphotungstates of the bases. During the analysis of arachin the phosphotungstic acid was not completely removed in the first precipitation and the barium phosphotungstate was whiter than usual. On adding more barium chloride a second precipitate, much smaller than the first and of a dirty gray color, resulted. This observation may be of some interest in connection with the nature of the "phosphotungstic acid humin nitrogen", concerning which very little is known at the present time.

*The preparation and analysis of arachin.* Arachin was prepared from fat-free unroasted peanut meal (*Arachis hypogaea*) according to the method of Johns and Jones (20) with slight modifications. The meal was extracted several times with redistilled gasoline to remove the oil. Five hundred grams of the meal was stirred into three liters of 10 per cent sodium chloride. After five hours the liquid was squeezed thru two thicknesses of cheese-cloth. A second extraction yielded very little protein. The suspended starch and the small shreds of fibrous material were removed by passing the liquid through a supercentrifuge. The resulting opalescent solution was diluted with three volumes of distilled water and saturated with carbon dioxide. It was found desirable to add a little diphenyl ether as a foam inhibitor. The precipitate, which formed readily, redissolved in fresh 10 per cent sodium chloride with the exception of a small residue which was discarded. Johns and Jones found that the arachin fraction was completely precipitated at 0.2 saturation with ammonium sulfate. We observed a marked precipitation at that point but the mother liquors developed a turbidity which did not clear up after two days standing. Additional ammonium sulfate to make the total 0.25 saturated was added and the suspended arachin soon settled out, yielding a compact precipitate. This was washed with a solution of salts of the same concentration as the mother liquors. The precipitate was again dissolved in the least volume of 10 per cent sodium chloride and dialyzed until free from chlorides. The preparation was washed four times with ethyl alcohol of increasing strength, twice with ether, and dried at a low temperature. The preparation was then reduced to a fine powder in the ball mill. A yield of 28 per cent of the fat-free meal resulted.

	Found	Johns and Jones (20)
Moisture	6.68	
Ash	0.55	
Total nitrogen	16.91	
Total nitrogen on the ash- and moisture-free basis	18.19	18.29
Amino nitrogen	2.65	

The nitrogen distribution by Van Slyke's method is given in Table I where it is compared with that of Johns and Jones.

*The isolation and analysis of edestin.* Edestin was prepared from ground hempseed (*Cannabis sativa* L.) which had previously been extracted with gasoline. The first extraction was made with half normal sodium benzoate according to the method of Reeves (39), clarified in the super centrifuge and the protein precipitated by pouring the filtrate into twenty volumes of distilled water. This yields a precipitate which is easily washed by decantation, and does not appear to go over to edesten as rapidly as does edestin in sodium chloride solution. For purification the precipitate was dispersed in 10 per cent sodium chloride according to the method of Osborne (35), but not all of the precipitate could be redissolved in warm 10 per cent sodium chloride. The insoluble residue, which contained some starch, was discarded. The salt was partially removed by dialysis against running water; the last was removed by stirring up the precipitate with water and centrifuging. The protein was finally washed with alcohol and ether and dried as reported under arachin. The yield was 13 per cent of the fat-free meal.

A nitrogen distribution analysis was made on the hydrolysate of a 3 gram sample. This is reported in Table I where the results are compared with those of Van Slyke (59). The following analyses were also made:

	Found	Osborne (35)
Moisture	5.01	
Ash	1.18	
Total nitrogen	17.35	
Total nitrogen on ash- and moisture-free basis	18.50	18.70
Amino nitrogen	2.00	

*The isolation and analysis of the globulin of the cantaloupe seed.* The method of Jones and Gersdorff (22) was followed in isolating the globulin from cantaloupe seed\* (*Cucumis melo*). The seeds were ground and most of the hulls removed by sifting. The oil was extracted with ether. Two hundred grams of meal was extracted with 2 liters of 2 per cent sodium chloride warmed to 60° C. The protein is easily and rapidly extracted, and crystallizes out on cooling the liquid. The globulin was purified by a second dispersion and precipitation. The yield was 48 per cent of the fat-free meal. Table I shows the nitrogen distribution on a 3 gram sample. The following analyses were also made:

	Found	Jones and Gersdorff (22)
Moisture	6.03	
Ash	1.25	
Total nitrogen	17.02	
Total nitrogen to the ash- and moisture-free basis	18.36	18.42
Amino nitrogen	1.78	

\* We are indebted to Mr. John F. Trost of the Purdue Experiment Station who very kindly supplied us with the cantaloupe seed.

TABLE I  
The Nitrogen Distribution of the Proteins used in This Study as determined by the Van Slyke Analysis and expressed in Per Cent of the Total Nitrogen

	Arachin	Deam- inized Arachin	Edestin	Deam- inized Edestin	Cantaloupe Seed Globulin	Durumin	Deam- inized Duru- min	Casein	Deam- inized Casein	Fibrin	Deam- inized Fibrin
Ammonia N	11.81	12.74	9.99	11.29	7.54	25.34	25.24	10.20	11.09	6.93	8.47
Hummin N	0.57		1.98		0.70			0.34	2.85		
Acid insoluble			1.18	1.07	0.64	0.38	0.70	0.34	1.63	1.44	1.98
Acid soluble			0.68	0.50	0.22	0.46	0.54	1.17	1.07	1.48	1.64
Basic N											
Arginine	23.77	20.50	27.05	24.83	28.41	6.44	4.68	9.20	7.09	14.16	12.32
Histidine	2.78	1.36	5.75	3.90	6.20	3.88	3.00	6.26	3.89	4.30	3.41
Cystine	0.74	0.20	1.49	1.21	0.78	1.33	0.68	1.05	0.26	0.89	0.20
Lysine	5.22	0.10	3.86	0.30	3.41	1.88	0.16	8.49	0.67	14.06	0.42
Phosphotungstic acid N Filtrate N	0.43	0.39	—	0.50	0.08	—	0.40	—	—	—	0.53
Amino	53.30	59.12	47.55	52.26	50.45	53.98	57.16	54.12	66.50	55.86	66.17
Non-amino	1.65	3.83	1.70	4.38	2.14	6.53	6.96	8.76	5.85	0.21	3.68
Total	100.27	99.76	99.37	100.24	99.71	100.22	99.52	99.59	98.20	99.47	98.82

Jones and Gersdorff (22)

Van Slyke (58)

Hoffman and Gortner (17)

Dunn and Lewis (8)

*The preparation and analysis of the deaminized proteins.* The deaminized proteins were all prepared in a uniform manner following the method of Dunn and Lewis (8). Fifty grams of the protein was suspended in 1 liter of distilled water. To this was added 70 c.c. glacial acetic acid drop by drop with continued stirring. Generally the proteins were completely peptized in 2 hours. When peptization was complete, 250 c.c. of a solution containing 20 grams of sodium nitrite was added slowly. A brownish-yellow precipitate soon formed, part of which settled out; the rest was caught by the escaping nitrogen gas and carried to the top. After standing for about 24 hours in the ice box the reaction mixture was allowed to warm to room temperature and was filtered on a Büchner funnel using hardened filter paper. Hot water was used to wash out the excess acid. Then alcohol was added. This appeared to liberate a small additional quantity of a gas, probably nitrogen. The alcohol extracted enough of a colored substance to color the filtrate a turbid brown. The protein was washed several times with alcohol, followed by 2 or 3 washings with ether and the product dried at a low temperature.

The material took on a cinnamon brown color on drying. The yields were uniformly good, giving over an 80 per cent recovery. Like the globulins, the products were ground in a ball mill until they were reduced to a fine powder. On drying the deaminized fibrin, a hard, vitreous mass resulted which required several hours treatment in the ball mill and resulted in an unusually high ash. A conductivity measurement was made on this product but its suspension gave practically the same value as the water used, indicating that the ash was porcelain dust from the ball mill.

The nitrogen distribution of the products is given in Table I, and for purposes of comparison, either the values in the literature or those of the untreated protein are included. Other analyses of the products are given in Table II.

TABLE II

The analyses of the deaminized proteins used in this study

	Ash	Moisture	Total Nitrogen	Total nitrogen on moisture- and ash-free basis
Deaminized arachin	0.48	6.10	16.39	17.55
Deaminized edestin	2.39	7.41	16.00	17.75
Deaminized casein	0.52	5.23	14.23	15.09
Deaminized fibrin	4.46	4.92	13.75	15.17
Deaminized durumin	0.28	5.67	15.98	16.99

*Methods used in measuring the binding.* The method used in determining the amount of acid bound is that used by Hoffman and Gortner (17). Exactly 0.1 gram of the protein was used in each case with the acid or alkali of the desired normality added. It was found desirable to make a paste of the protein with part of the solution and then transfer this to a 10 c.c. volumetric flask,

using the last of the solution as wash water. This procedure insured thoroughly wetting the finely divided powder. Half an hour was allowed for equilibrium to be reached and the measurements were made at  $30^{\circ}\text{C.} \pm 0.5$ .

The Bailey electrode was found very convenient; equilibrium was reached in two or three minutes with shaking. A Leeds and Northrup potentiometer, Type K, was used with a Leeds and Northrup Type R high-sensitivity galvanometer. The potential was measured with the electrode in the series  $\text{H}_2$ ,  $\text{H}^+ \parallel \text{KCl (N) Hg and Hg}_2\text{Cl}_2$ . The millivolt readings were converted into hydrogen ion concentration and pH values from the tables of Schmidt and Hoagland (51).

The calculations of the equivalents of acid or alkali bound were made by the equation:  $n = N - N'$ , where  $n$  is the normality of acid bound by 0.1 gm. protein and contained in 10 c.c. solution,  $N$  is the original normality, and  $N'$  the normality after equilibrium.  $N'$  was read off a curve made by plotting the  $\text{C}_{\text{H}^+}$  of varying normalities of HCl in water from the data of Tables III and IV. Experimental data are shown in Tables V to XX. As explained by Hoffman and Gortner (17) no temperature corrections need be introduced. From  $n$ , the equivalent bound per gram is obtained by dividing by 10 and multiplying by a correction factor to take care of the ash and moisture content of the protein.

It is to be noted that one assumption is made in calculating the binding capacity from potentiometric data. We have calculated the hydrogen ion concentration of a solution of hydrochloric acid or of sodium hydroxide in the presence of a protein on the assumption that the protein does not interfere and that a given E.M.F. indicates a given hydrogen ion concentration from which acid normality can be calculated. It is recognized that neutral salts affect the hydrogen ion concentration of dilute hydrochloric acid as shown by Harned (11, 12) and Brønsted and LaMer (3). However, we know of no measurements of the effects of electrolytes as weak as the proteins.

At this point it should be remarked that we have used the older terminology of "hydrogen ion concentration" instead of "hydrogen ion activity". The real relationship between the two is given by the expression:

Hydrogen ion activity =  $\gamma \times$  hydrogen ion concentration, where  $\gamma$  is the activity coefficient of Lewis, Debye and others. In other words, we recognize that the potentials measured give us the intensity factor and not the quantity factor. Our usage may be justified on three grounds: first, in citing the older workers it is convenient to use their terminology; and second, at present the values for  $\lambda$  have not been accurately determined for values above 0.1 normal concentrations, whereas we extended our studies beyond that point. Also a recent paper by Beutner and Menitoff (1) showed that "electromotive forces \* \* \* arise whenever the salt solutions are bordering on a salt-free layer containing a colloid" but that at present it is impossible to calculate the correction to be applied.

The experimental data are shown in Tables III-XX.

TABLE III

The potentiometric determination of the hydrogen ion concentration of varying normalities of HCl at 30°C.

N	E.M.F.	pH	$C_{H^+}$
0.002	435.9	2.723	0.00260
0.004	421.7	2.345	0.00453
0.008	402.7	2.024	0.00945
0.016	388.5	1.783	0.01650
0.024	379.0	1.623	0.0238
0.032	374.0	1.521	0.0301
0.040	368.7	1.449	0.0357
0.060	357.1	1.253	0.0559
0.080	348.0	1.099	0.0797
0.120	337.8	0.952	0.1184
0.160	331.1	0.813	0.1529
0.240	319.9	0.624	0.2379
0.360	309.6	0.450	0.3562

TABLE IV

The potentiometric determination of the hydroxyl ion concentration of varying concentrations of sodium hydroxide at 30°C.

N	E.M.F.	pH	$C_{OH^-}$
0.004	960.5	11.454	0.00288
0.010	981.4	11.807	0.00646
0.020	1005.4	12.213	0.01648
0.030	1013.1	12.343	0.0222
0.040	1018.0	12.426	0.0270
0.060	1028.5	12.604	0.0406
0.080	1036.6	12.740	0.0556
0.120	1044.9	12.880	0.0770
0.160	1052.9	13.015	0.1044
0.200	1057.9	13.100	0.1275
0.250	1061.1	13.155	0.1450
0.300	1064.3	13.208	0.1635
0.400	1071.7	13.334	0.2179
0.500	1076.0	13.406	0.2580



TABLE V

The potentiometric titration of arachin (1 per cent) with varying normalities of HCl at 30° C.

N	E.M.F.	pH	C <sub>H</sub> <sup>+</sup>	N'	n
—	478.0	3.296	0.506 × 10 <sup>-3</sup>	0.00048	—
0.002	467.0	3.111	0.775 × 10 <sup>-3</sup>	0.00065	0.00135
0.004	451.0	2.840	0.145 × 10 <sup>-2</sup>	0.0012	0.0028
0.008	429.5	2.477	0.334 × 10 <sup>-2</sup>	0.0029	0.0051
0.016	408.8	2.125	0.0075	0.007	0.009
0.024	397.0	1.927	0.0118	0.012	0.012
0.032	396.0	1.893	0.0128	0.013	0.019
0.071	376.0	1.572	0.0268	0.028	0.043
0.120	349.1	1.118	0.0763	0.080	0.040
0.180	337.0	0.913	0.1220	0.128	0.052
0.240	329.4	0.785	0.1644	0.170	0.070
0.300	321.3	0.647	0.2255	0.229	0.071

TABLE VI

The potentiometric titration of the globulin of the cantaloupe seed (1 per cent) with varying normalities of HCl at 30° C.

N	E.M.F.	pH	C <sub>H</sub> <sup>+</sup>	N'	n
—	558.5	4.648	0.22 × 10 <sup>-4</sup>	0.00002	—
0.002	515.5	3.931	0.118 × 10 <sup>-3</sup>	0.0001	0.0019
0.004	485.8	3.424	0.373 × 10 <sup>-3</sup>	0.0003	0.0037
0.008	446.0	2.756	0.176 × 10 <sup>-2</sup>	0.0016	0.0064
0.016	411.6	2.174	0.0067	0.006	0.010
0.024	406.5	2.087	0.817 × 10 <sup>-2</sup>	0.008	0.016
0.032	390.1	1.811	0.155 × 10 <sup>-1</sup>	0.016	0.016
0.080	358.5	1.277	0.053	0.056	0.024
0.120	347.8	1.096	0.0803	0.090	0.030
0.160	337.7	0.925	0.1188	0.124	0.036
0.240	327.8	0.758	0.1748	0.181	0.059
0.300	321.7	0.654	0.222	0.227	0.073

TABLE VII

The potentiometric titration of edestin (1 per cent) with varying normalities of HCl at 30°C.

N	E.M.F.	pH	C <sub>R</sub> <sup>+</sup>	N'	n
—	659.7	6.346	0.43 × 10 <sup>-8</sup>	—	—
0.002	561.0	4.700	0.00002	0.000018	0.00199
0.004	512.6	3.883	0.00013	0.00011	0.00389
0.008	484.7	3.410	0.0039	0.00032	0.00768
0.016	424.8	2.400	0.0040	0.0045	0.0115
0.024	403.5	2.038	0.0092	0.0090	0.015
0.032	386.4	1.736	0.0179	0.018	0.014
0.040	377.5	1.598	0.0253	0.026	0.014
0.080	356.2	1.137	0.058	0.061	0.019
0.120	344.3	1.036	0.092	0.097	0.023
0.160	336.3	0.901	0.126	0.131	0.029
0.240	324.2	0.700	0.201	0.206	0.034
0.300	317.8	0.589	0.258	0.263	0.037

TABLE VIII

The potentiometric titration of deaminized arachin (1 per cent) with varying normalities of HCl at 30°C.

N	E.M.F.	pH	C <sub>R</sub> <sup>+</sup>	N'	n
—	468.0	3.128	0.746 × 10 <sup>-3</sup>	0.00068	—
0.002	459.0	2.975	0.00106	0.0009	0.0011
0.004	440.0	2.654	0.00222	0.0018	0.0022
0.008	414.0	2.215	0.00611	0.0053	0.002
0.016	404.6	2.022	0.0095	0.009	0.007
0.024	392.0	1.843	0.01435	0.014	0.010
0.032	384.0	1.707	0.01965	0.021	0.011
0.071	364.0	1.367	0.04275	0.045	0.026
0.120	347.4	1.089	0.0816	0.086	0.034
0.180	335.9	0.894	0.1275	0.133	0.047
0.240	326.7	0.739	0.1825	0.189	0.051
0.300	319.9	0.624	0.2379	0.240	0.060

TABLE IX

The potentiometric titration of deaminized edestin (1 per cent) with varying normalities of HCl at 30° C.

N	E.M.F.	pH	C <sub>H</sub> <sup>+</sup>	N'	n
—	467.8	3.125	0.752 × 10 <sup>-3</sup>	—	—
0.002	452.1	2.859	0.00139	0.00105	0.001
0.004	434.6	2.563	0.00273	0.00204	0.00196
0.008	417.2	2.268	0.00539	0.005	0.003
0.016	399.5	1.969	0.0107	0.011	0.005
0.024	395.6	1.903	0.0125	0.014	0.010
0.040	376.8	1.523	0.0260	0.028	0.012
0.080	355.3	1.222	0.0597	0.063	0.017
0.120	343.8	1.028	0.0939	0.099	0.021
0.180	332.5	0.837	0.1458	0.151	0.029
0.240	325.2	0.713	0.1965	0.203	0.037
0.300	317.2	0.578	0.2640	0.273	0.027

TABLE X

The potentiometric titration of deaminized casein (1 per cent) with varying normalities of HCl at 30° C.

N	E.M.F.	pH	C <sub>H</sub> <sup>+</sup>	N'	n
—	530.7	4.189	0.658 × 10 <sup>-4</sup>	0.58 × 10 <sup>-4</sup>	—
0.002	449.9	2.821	0.00151	0.00115	0.00085
0.004	432.4	2.526	0.00298	0.0024	0.0016
0.008	412.8	2.195	0.00639	0.006	0.002
0.016	396.6	1.920	0.0120	0.011	0.005
0.024	388.5	1.784	0.0165	0.016	0.008
0.032	380.6	1.650	0.0224	0.023	0.009
0.040	375.3	1.560	0.0275	0.030	0.010
0.060	362.7	1.348	0.0449	0.048	0.012
0.080	354.6	1.210	0.0616	0.065	0.015
0.120	342.3	1.002	0.098	0.103	0.017
0.160	334.5	0.871	0.135	0.140	0.020
0.200	328.4	0.768	0.171	0.178	0.022
0.240	323.0	0.676	0.211	0.216	0.024
0.300	317.6	0.585	0.260	0.266	0.034
0.400	309.0	0.454	0.353	0.361	0.039

TABLE XI

The potentiometric titration of deaminized durummin (1 per cent) with varying concentrations of HCl at 30° C.

N	E.M.F.	pH	C <sub>N</sub> <sup>+</sup>	N'	n
—	512.6	3.881	.1312 × 10 <sup>-3</sup>	—	—
0.002	452.1	2.857	.1389 × 10 <sup>-2</sup>	0.0011	0.0009
0.004	432.7	2.531	.2946 × 10 <sup>-2</sup>	0.0026	0.0014
0.008	412.0	2.181	.0066	0.0056	0.0024
0.016	397.2	1.930	.0117	0.0118	0.004
0.024	383.3	1.696	.0202	0.0203	0.004
0.032	378.0	1.606	.0248	0.026	0.006
0.040	374.2	1.545	.0287	0.030	0.010
0.080	354.3	1.180	.0649	0.068	0.012
0.120	339.9	0.978	.1046	0.106	0.014
0.180	330.3	0.787	.1587	0.166	0.014
0.240	322.1	0.661	.218	0.220	0.020
0.300	320.6	0.634	.250	0.252	0.048

TABLE XII

The potentiometric titration of deaminized fibrin (1 per cent) with varying normalities of HCl at 30° C.

N	E.M.F.	pH	C <sub>N</sub> <sup>+</sup>	N'	n
—	495.9	3.599	0.252 × 10 <sup>-3</sup>	—	—
0.002	458.2	2.962	0.1092 × 10 <sup>-2</sup>	0.00084	0.0012
0.004	443.5	2.713	0.1935 × 10 <sup>-2</sup>	0.00149	0.0025
0.008	416.8	2.212	0.5474 × 10 <sup>-2</sup>	0.00483	0.0032
0.016	395.7	1.905	0.01245	0.0130	0.003
0.024	386.0	1.741	0.0182	0.0194	0.005
0.032	376.9	1.582	0.0257	0.0276	0.005
0.040	369.5	1.445	0.0345	0.0360	0.004
0.080	351.9	1.165	0.0659	0.0695	0.011
0.120	343.4	1.022	0.0954	0.1000	0.020
0.180	332.5	0.837	0.1458	0.1515	0.029
0.240	325.2	0.713	0.1935	0.2000	0.040
0.300	318.5	0.601	0.2510	0.2620	0.038

TABLE XIII

The potentiometric titration of arachin (1 per cent) with varying normalities of NaOH at 30° C.

N	E.M.F.	pH	$C_{OH^-}$	N'	n
0.004	731.0	7.574	$3.94 \times 10^{-7}$	$5.2 \times 10^{-7}$	0.004
0.010	812.4	8.950	$9.008 \times 10^{-6}$	0.000012	0.010
0.020	957.5	11.403	$2.56 \times 10^{-3}$	0.005	0.015
0.030	982.9	11.832	$6.85 \times 10^{-3}$	0.013	0.017
0.040	999.8	12.118	0.0133	0.020	0.020
0.060	1012.8	12.338	0.0220	0.035	0.025
0.080	1023.5	12.519	0.0335	0.049	0.031
0.120	1032.6	12.672	0.048	0.073	0.047
0.160	1040.2	12.801	0.064	0.098	0.062
0.200	1050.4	12.974	0.095	0.147	0.053
0.250	1054.6	13.044	0.112	0.179	0.072
0.300	1055.2	13.054	0.122	0.198	0.102
0.350	1065.4	13.227	0.173	0.296	0.104
0.400	1069.1	13.300	0.197	0.351	0.129

TABLE XIV

The potentiometric titration of the cantaloupe seed globulin (1 per cent) with varying normalities of sodium hydroxide at 30° C.

N	E.M.F.	pH	$C_{OH^-}$	N'	n
0.004	785.1	8.489	$3.112 \times 10^{-6}$	—	0.004
0.010	890.5	10.271	$1.885 \times 10^{-4}$	—	0.010
0.020	968.4	11.587	0.00391	0.008	0.012
0.030	989.5	11.944	0.00891	0.012	0.018
0.040	998.9	12.103	0.01285	0.0185	0.022
0.060	1010.6	12.300	0.0202	0.0295	0.031
0.080	1024.8	12.541	0.0351	0.051	0.029
0.120	1040.5	12.807	0.0648	0.089	0.031
0.160	1044.9	12.880	0.0770	0.120	0.040
0.200	1050.9	12.981	0.0975	0.153	0.047
0.250	1055.3	13.056	0.1154	0.184	0.066
0.300	1059.7	13.134	0.1368	0.226	0.074
0.350	1061.4	13.160	0.1462	0.245	0.105
0.500	1070.2	13.308	0.2056	0.372	0.128

TABLE XV

The potentiometric titration of edestin (1 per cent) with varying concentrations of sodium hydroxide at 30° C.

N	E.M.F.	pH	$C_{OH^-}$	N'	n
0.004	907.8	10.563	$3.706 \times 10^{-4}$	0.0004	0.0036
0.010	954.1	11.348	$2.244 \times 10^{-3}$	0.0034	0.0066
0.020	984.7	11.846	$7.076 \times 10^{-3}$	0.011	0.009
0.030	995.4	12.078	$1.123 \times 10^{-2}$	0.015	0.015
0.040	1007.7	12.252	$1.809 \times 10^{-2}$	0.025	0.015
0.060	1017.6	12.419	0.0265	0.040	0.020
0.080	1020.5	12.469	0.0297	0.044	0.036
0.120	1037.7	12.759	0.0581	0.078	0.042
0.160	1043.4	12.855	0.0741	0.114	0.046
0.200	1049.8	12.964	0.0932	0.146	0.054
0.250	1054.9	13.049	0.1136	0.182	0.068
0.300	1056.8	13.082	0.1221	0.199	0.101
0.350	1062.5	13.179	0.1522	0.258	0.092
0.400	1063.1	13.188	0.1557	0.265	0.135

TABLE XVI

The potentiometric titration of deaminized arachin (1 per cent) with varying normalities of NaOH at 30° C.

N	E.M.F.	pH	$C_{OH^-}$	N'	n
0.004	736.0	7.658	$4.6 \times 10^{-7}$	$1 \times 10^{-6}$	0.004
0.010	886.0	10.204	$1.624 \times 10^{-4}$	$2.7 \times 10^{-4}$	0.0097
0.020	975.4	11.706	$5.14 \times 10^{-3}$	0.0062	0.0138
0.030	998.9	12.102	0.01285	0.0185	0.0115
0.040	1005.3	12.211	0.0164	0.024	0.016
0.060	1011.0	12.307	0.0205	0.039	0.021
0.080	1026.4	12.568	0.0374	0.058	0.022
0.120	1032.2	12.682	0.0488	0.074	0.046
0.160	1041.8	12.828	0.0682	0.110	0.050
0.200	1049.2	12.953	0.0911	0.142	0.058
0.250	1054.3	13.039	0.1109	0.177	0.073
0.300	1059.2	13.122	0.1340	0.222	0.078
0.350	1063.0	13.186	0.1550	0.263	0.087
0.400	1067.3	13.259	0.1841	0.328	0.072

TABLE XVII

The potentiometric titration of deaminized edestin (1 per cent) with varying normalities of NaOH at 30°C.

N	E.M.F.	pH	$C_{OH^-}$	N'	n
0.004	710.0	7.219	$1.68 \times 10^{-7}$	$2 \times 10^{-7}$	0.004
0.010	878.7	10.071	$1.19 \times 10^{-4}$	$1.7 \times 10^{-4}$	0.010
0.020	971.0	11.631	$4.32 \times 10^{-3}$	0.0048	0.0152
0.030	979.7	11.778	$6.07 \times 10^{-3}$	0.0127	0.0173
0.040	998.7	12.101	0.01275	0.019	0.021
0.060	1012.8	12.337	0.0222	0.035	0.025
0.080	1024.7	12.539	0.0350	0.052	0.028
0.120	1033.8	12.693	0.0499	0.076	0.044
0.160	1043.3	12.853	0.0722	0.112	0.048
0.180	1047.5	12.925	0.0853	0.132	0.048
0.200	1048.9	12.949	0.0901	0.141	0.059
0.250	1055.9	13.053	0.1180	0.181	0.069
0.300	1058.2	13.088	0.1288	0.210	0.090
0.350	1061.5	13.161	0.1473	0.247	0.103
0.400	1064.2	13.206	0.1640	0.282	0.118

TABLE XVIII

The potentiometric titration of deaminized casein (1 per cent) with varying concentrations of NaOH at 30°C.

N	E.M.F.	pH	$C_{OH^-}$	N'	n
0.004	720.9	7.403	$2.56 \times 10^{-7}$	$2 \times 10^{-7}$	0.004
0.010	755.9	7.994	$9.98 \times 10^{-7}$	$7.4 \times 10^{-7}$	0.010
0.020	945.5	11.200	$1.61 \times 10^{-3}$	0.002	0.018
0.030	979.9	11.781	$6.12 \times 10^{-3}$	0.009	0.021
0.040	995.4	12.044	0.0112	0.016	0.024
0.060	1013.3	12.346	0.0225	0.033	0.027
0.080	1024.9	12.542	0.0353	0.052	0.028
0.120	1038.3	12.769	0.0594	0.090	0.030
0.160	1046.1	12.901	0.0807	0.125	0.035
0.180	1047.9	12.931	0.0867	0.134	0.046
0.200	1051.2	12.986	0.0980	0.153	0.047
0.250	1056.2	13.071	0.1194	0.193	0.057
0.300	1062.7	13.182	0.1534	0.259	0.041
0.350	1064.2	13.206	0.1628	0.279	0.071
0.400	1066.8	13.251	0.1809	0.320	0.080

TABLE XIX

The potentiometric titration of deaminized durumini (1 per cent) with varying concentrations of NaOH at 30°C.

N	E.M.F.	pH	$C_{OH^-}$	N'	n
0.004	907.8	10.563	$3.706 \times 10^{-4}$	0.0004	0.0036
0.010	957.1	11.396	$2.52 \times 10^{-3}$	0.0047	0.0053
0.020	992.5	11.995	0.0068	0.0120	0.008
0.030	1003.8	12.185	0.0155	0.022	0.008
0.040	1012.7	12.336	0.0218	0.031	0.009
0.060	1022.3	12.498	0.0320	0.050	0.010
0.080	1031.6	12.655	0.0458	0.068	0.012
0.120	1041.2	12.815	0.0672	0.104	0.016
0.160	1047.3	12.921	0.0846	0.132	0.028
0.200	1052.1	13.002	0.1001	0.158	0.042
0.250	1059.2	13.122	0.1341	0.220	0.030
0.300	1061.5	13.195	0.1468	0.247	0.053
0.350	1065.0	13.220	0.1680	0.291	0.059
0.400	1068.9	13.286	0.1950	0.337	0.063

TABLE XX

The potentiometric titration of deaminized fibrin (1 per cent) with varying normalities of NaOH at 30°C.

N	E.M.F.	pH	$C_{OH^-}$	N'	n
0.004	707.6	7.178	$1.526 \times 10^{-7}$	$2 \times 10^{-7}$	0.004
0.010	861.0	9.772	$5.99 \times 10^{-6}$	$8 \times 10^{-6}$	0.010
0.020	962.0	11.479	$3.05 \times 10^{-5}$	0.0045	0.0155
0.030	983.9	11.849	$7.12 \times 10^{-5}$	0.010	0.020
0.040	997.8	12.085	0.0123	0.015	0.025
0.060	1006.8	12.237	0.0174	0.024	0.036
0.080	1029.7	12.624	0.0425	0.060	0.020
0.120	1041.1	12.816	0.0664	0.101	0.019
0.160	1047.0	12.916	0.0836	0.128	0.032
0.200	1052.1	13.002	0.1015	0.155	0.045
0.250	1056.5	13.077	0.1208	0.196	0.052
0.300	1061.1	13.155	0.1445	0.241	0.059
0.350	1063.2	13.189	0.1560	0.266	0.084
0.400	1065.4	13.227	0.1709	0.297	0.103



## IV. Discussion

*The preparation and analysis of the proteins used.* The three globulins were prepared and analyzed according to the method of Van Slyke (58). Our findings agree very well with those reported in the literature. It is to be noted that as a group of proteins they are uniformly high in arginine, and differ from the prolamines studied by Hoffman and Gortner (17) in that the globulins contain only 50 per cent of the amide nitrogen of the prolamines and 2 or 3 times as much lysine nitrogen.

The method of Dunn and Lewis (7) proved to be very satisfactory in preparing the deaminized proteins in good yields. A comparison of the nitrogen distribution in each of the deaminized proteins with that of the untreated proteins shows clearly that, with the possible exception of the cystine and the histidine fractions, only the lysine nitrogen is altered. This confirms the theory of Van Slyke and Birchard (59) that the  $\epsilon$ -amino group in lysine is free in native proteins and loses its nitrogen when treated with an excess of nitrous acid. In keeping with their theory, the filtrate from the bases should gain one-half of the total nitrogen of lysine. If our values are corrected for the solubility of the bases, as is the usual procedure, we find that from 40 to 65 per cent of the total lysine nitrogen appears in the filtrate from the bases.

The amide nitrogen and the arginine values are not altered by the nitrous acid treatment, and the histidine fraction does not appear to be greatly changed by the process. Dunn and Lewis report a lower value in their deaminized casein which they ascribe to errors in analysis.

Although our deaminized proteins did not liberate any nitrogen in the Van Slyke apparatus, the analysis of the hydrolysates gave a calculated value of lysine nitrogen of from 0.1 to 0.6 per cent. These values are low in comparison with the total lysine nitrogen of the native proteins and are not greatly in excess of the errors found by Gortner and Sandstrom (9) in a study of the accuracy of the Van Slyke nitrogen distribution of a protein.

The values for cystine nitrogen of the deaminized proteins by the barium sulfate method are uniformly lower than those of the corresponding native proteins, and may indicate a partial conversion of cystine to cysteic acid with nitrous acid, since Hopkins and Dixon (18) and Kendall and Nord (23) have shown that cystine is very readily oxidized.

*The binding of acid and alkali by the proteins.* The values for the amount of acid or alkali bound were plotted as functions of the equilibrium concentrations. These were compared with the curves resulting when the logarithmic values were substituted. Since a preliminary inspection seemed to indicate that we were dealing with curves that looked very much like adsorption curves beyond the first two or three points plotted, it was thought desirable to calculate the values for the constants,  $a$  and  $b$ , in the equation:

$$\log n = \log a + b \log N'$$

The "method of averages" as given by Lipka (27, p. 126) was used. This method consists in calculating the values for the constants  $a$  and  $b$  of this

straight line formula, such that the algebraic sum of the residuals is equal to zero. The data is divided into 2 groups and the pair of simultaneous equations constructed:

$$\begin{cases} \Sigma(\log n) = r \log a + b \Sigma(\log N') \\ \Sigma(\log n) = r \log a + b \Sigma(\log N') \end{cases}$$

where  $r$  is the number of observations in the group. From these equations  $\log a$  and  $b$  are calculated. The values thus obtained from the data of Tables V-XX are given in Tables XXI and XXII.

TABLE XXI

The values of the constants,  $\log a$  and  $b$ , in the equation:  $\log n = \log a + b \log N'$ , for the binding of hydrochloric acid by the various proteins, as calculated from the data of Tables V-XII. (T. 30°C.)

	$\log a$	$b$
Arachin	-0.46077	0.7581
Cantaloupe seed globulin	-0.3837	0.6087
Edestin	-1.4209	0.20656
Deaminized arachin	-0.62794	0.7914
Deaminized edestin	-0.5051	1.0197
Deaminized casein	-0.35409	1.2507
Deaminized fibrin	-1.5397	0.5058
Deaminized durumini	0.9440	0.8241

TABLE XXII

The values of the constants,  $\log a$  and  $b$ , in the equation:  $\log n = a + b \log N'$  for the binding of sodium, hydroxide by the various proteins, as calculated from the data of Tables XIII to XX. (T 30°C.)

	$\log a$	$b$
Arachin	-0.8218	0.4522
Edestin	-0.6344	0.6477
Cantaloupe seed globulin	-0.7538	0.5617
Deaminized arachin	-1.0548	0.3376
Deaminized edestin	-0.2259	1.0394
Deaminized casein	-1.0122	0.3613
Deaminized fibrin	-0.8275	0.5268
Deaminized durumini	-1.2374	0.4122

The constant  $b$  of the logarithmic curve gives the slope of the line and is an index of the rate of change in the binding with varying acidity or alkalinity of the equilibrium system. On the acid side the values for the globulins vary from 0.2066 to 0.7578 and are lower than the values previously determined in this laboratory for the prolamines which gave values of from -0.6921 to -0.9613. It is to be noted that the values of Hoffman and Gortner (17) are negative due to the fact that they used the pH of the equilibrium concen-

trations as the one variable. The values for casein and fibrin with HCl are lower than those for the prolamines and fall within the range of the globulins.

On the alkaline side the values of  $b$  for the three globulins lie very close together (0.4522 to 0.6477) and are consistently lower than the corresponding values for the prolamines and fibrin and casein.

There is no regularity in the effects of deamination on the calculated slopes. A comparison of the constants of  $\log a$  as between arachin or edestin and their deaminized products show that the values are lowered. Probably this may be explained on the basis of the lessened basicity of the deaminized products with less binding of acid in the lower concentrations.

A comparison was made between the globulins and their deaminized derivatives with regard to the amount of acid bound at the equilibrium pH of 2.5. The values for casein, fibrin, and durummin are taken from the data of Hoffman and Gortner (17). To make conditions more nearly comparable the mean values of their data for 22° and 35° were taken for comparison with our values which were obtained at 30°. This comparison is shown in Table XXIII. Column 2 indicates the gram equivalents of acid bound per gram of protein; column 3 gives the corresponding value for the deaminized product; column 4 is obtained by subtracting the values of column 3 from those of column 2, and represents the equivalents of acid-binding capacity lost by deamination. These values may be compared with the lysine nitrogen as per cent of the total nitrogen in the original protein (column 5). With the exception of edestin we find a striking parallelism between the lysine nitrogen content and the capacity of a protein to bind hydrochloric acid over that of the deaminized product.

TABLE XXIII

Showing the effect of deamination on the acid-binding capacity of the proteins

Protein	Gram equivalents of acid bound per gram orig. protein	Gram equivalents of acid bound per gram deaminized protein	Gram equivalents of acid-binding lost by deamination	Lysine N as per cent of total N in orig. protein
Edestin	0.00115	0.00020	0.00095	3.60
Fibrin	0.00096	0.00025	0.00071	14.06
Casein	0.00085	0.00016	0.00069	8.49
Arachin	0.00051	0.00022	0.00029	5.00
Durumin	0.00034	0.00014	0.00020	1.88
Cantaloupe seed globulin	0.00076	—	—	3.28

Possibly our lysine value for edestin is low, since Plimmer (38, p. 115) reports a lysine content of 1.7 per cent of the amino acid on actual isolation and Schryver (53) reports a value of 3.28 for the nitrogen percentage of  $\beta$ -hydroxylysine also obtained by isolation. These are undoubtedly minimum values. However, our value agrees well with that of Van Slyke. It

is evident from a comparison of the figures in columns 2 and 5 of Table XXIII that the  $\epsilon$ -amino group of lysine is not alone responsible for acid-binding capacity. One would judge from Table XXIII that nitrous acid does more than remove the  $\epsilon$ -amino group of lysine, since the acid-binding capacity of the deaminized proteins is very nearly uniform in spite of the great differences in acid-binding capacity of the native proteins.

Table XXIII, taken in conjunction with Table I, indicates that in this series of proteins, or at least in edestin, there is present some basic group other than the  $\epsilon$ -amino group of lysine which binds acid. In the earlier study of the prolamines Hoffman and Gortner (17) found a correlation coefficient of  $r = 0.992 \pm 0.003$  between the free amino nitrogen of the protein (the  $\epsilon$ -group of lysine) and the gram equivalents of acid bound at pH 2.8. It is obvious that no such relationship applies to edestin. Neither does it appear that the arginine or histidine content of edestin can be responsible for its singularly high acid-binding capacity, for the histidine and lysine content is essentially the same in both the cantaloupe seed globulin and in edestin, and the arginine content is even higher in the cantaloupe seed globulin than in edestin. In spite of these relationships the acid-binding capacity of the cantaloupe seed globulin is much lower than is the case for edestin.

The available analyses fail to indicate any explanation for the high acid binding of edestin, although it will be noted that it must be due to some group which is destroyed by the treatment with nitrous acid.

Just the reverse effect of deaminization is to be found on the alkaline side. Deaminization shifts the isoelectric point of the protein to the acid side, and, with the exception of arachin, somewhat more alkali is bound by the deaminized proteins at a pH of 10.5 than is the case with the natural protein. Table XXIV shows this very clearly.

The gain of 200 per cent in the base-binding capacity of edestin and durummin, and of 50 per cent in the case of fibrin cannot be accounted for on the hypothesis that base binding by proteins is purely stoichiometrical and involves only combination of carboxyl groups with the base. In the case of a deaminized protein there are, presumably, no more free carboxyl groups than

TABLE XXIV

Showing the effect of deaminization on the alkali-binding capacity of the proteins

Protein	Gram equivalents of alkali bound per gram orig. protein	Gram equivalents of alkali bound per gram deaminized protein	Change in gram equivalents of alkali binding due to deaminization
Arachin	0.00112	0.00103	-0.00009
Edestin	0.00036	0.00111	+0.00075
Casein	0.00146	0.00163	+0.00017
Fibrin	0.00086	0.00118	+0.00032
Durumin	0.00012	0.00036	+0.00024
Cantaloupe seed globulin	0.00102	—	—

were present in the native protein and accordingly the base binding should not be greatly changed following deaminization. That it is changed for certain of the proteins is evident; however, there is as yet no satisfactory explanation for the fact that the base-binding capacities of edestin and fibrin are markedly increased by deaminization whereas those of arachin and casein are only slightly altered.

#### V. Summary and Conclusions

1. Edestin, arachin, and the globulin of the cantaloupe seed were prepared and analyzed for their nitrogen distribution by the method of Van Slyke.
2. Edestin, arachin, casein, fibrin, and durumins were deaminized and the resulting products analyzed by determining their nitrogen distribution.
3. The free amino group of lysine is attacked by the nitrous acid with the result that the lysine fraction is lost to the phosphotungstic acid fraction.
4. Probably histidine and cystine are slightly altered by the treatment with nitrous acid.
5. Varying concentrations of acid and alkali were added to the proteins and the potentiometric determinations of the hydrogen ion concentrations were made on the system at equilibrium.
6. From a preliminary inspection of the curves resulting when the quantity of acid or alkali bound was plotted as a function of equilibrium concentrations, it appeared that our proteins behaved very similarly to the prolamines previously studied in this laboratory.
7. With the exception of edestin, the quantity of acid bound by the proteins is roughly proportional to the lysine content of the proteins.
8. It is postulated that some basic group other than the  $\epsilon$ -amino group of lysine must be responsible for the acid-binding capacity of edestin.
9. For all five proteins studied the acid-binding capacity is greatly decreased when the proteins are deaminized.
10. The quantities of sodium hydroxide bound at pH = 10.5 by the native proteins and their deaminized products were compared, and it was found that in four of the five cases more alkali was needed to bring the deaminized protein to that hydroxyl ion concentration than was required for the untreated protein.
11. From the data beyond the range of pH 2.5 and 10.5 the constants,  $\log a$  and  $b$ , were calculated from the logarithmic values.
12. The constants for the globulins and the group of deaminized proteins differ amongst themselves but are very similar to the values obtained in this laboratory for the prolamines, except that the values for  $b$ , the slope of the line, for the globulins are uniformly lower than those for the prolamines.
13. As in the case of the prolamines this latter type of binding cannot be accounted for on the basis of primary valences, and since the empirically derived Freundlich adsorption isotherm can be made to fit the data, we conclude that in these regions we are dealing with typical adsorption phenomena.

## VI. Literature Cited

- (1) Beutner, R., and Menitoff, A.  
1927. Influence of salt content of colloids upon their electromotive forces which may explain bioelectric currents. *J. Biol. Chem.*, **72**, 759-763.
- (2) Blasel, L., and Matula, J.  
1914. Untersuchungen über physikalische Zustandsänderungen der Kolloide. XVI. Versuche am Desamidoglutin. *Biochem. Z.*, **58**, 417-450, illus.
- (3) Brønsted, J. N., and LaMer, V. K.  
1924. The activity coefficients of ions in very dilute solutions. *J. Am. Chem. Soc.* **46**, 555-573, illus.
- (4) Bugarsky, S., and Liebermann, L.  
1898. Über das Bindungsvermögen eiweissartiger Körper für Salzsäure, Natrium-hydroxyd und Kochsals. *Pflüger's Arch. für die gesamte Physiol.*, **72**, 51-74.
- (5) Cohn, E. J.  
1925. The physical chemistry of the proteins. *Physiol. Rev.*, **5**, 349-437, illus.
- (6) Csapo, J.  
1923. Einfluss der Neutralsalze auf die Säurebindung der Gelatine. *Biochem. Z.*, **159**, 53-57, illus.
- (7) Dunn, M. S., and Lewis, H. B.  
1921. The action of nitrous acid on casein. *J. Biol. Chem.*, **491**, 327-341.
- (8) Dunn, M. S., and Lewis, H. B.  
1921. A comparative study of the hydrolysis of casein and deaminized casein by proteolytic enzymes. *J. Biol. Chem.*, **49**, 342-350, illus.
- (9) Gortner, R. A., and Sandstrom, W. M.  
1925. Proline and tryptophan as factors influencing the accuracy of Van Slyke's method for the determination of nitrogen distribution in proteins. *J. Am. Chem. Soc.*, **47**, 1663-1671.
- (10) Hardy, W. B.  
1905. Colloidal solutions—The globulins. *J. Physiol.*, **33**, 251-337, illus.
- (11) Harned, H. S.  
1920. The thermodynamic properties of the ions of some strong electrolytes and of the hydrogen ion in solutions of tenth molar hydrochloric acid containing uni-valent salts. *J. Am. Chem. Soc.*, **42**, 1808-1832, illus.
- (12) Harned, H. S.  
1925. The activity coefficient of sodium hydroxide in sodium chloride solutions. *J. Am. Chem. Soc.*, **47**, 684-689, illus.
- (13) Hitchcock, D. I.  
1922. The colloidal behavior of edestin. *J. Gen. Physiol.*, **4**, 597.
- (14) Hitchcock, D. I.  
1922. The colloidal behavior of serum globulin. *J. Gen. Physiol.*, **5**, 35-44, illus.
- (15) Hitchcock, D. I.  
1923. The ionization of protein chlorides. *J. Gen. Physiol.*, **5**, 383-394, illus.
- (16) Hitchcock, D. I.  
1923. The combination of deaminized gelatin with hydrochloric acid. *J. Gen. Physiol.*, **6**, 95-104, illus.
- (17) Hoffman, W. F., and Gortner, R. A.  
1925. Physico-chemical studies on proteins. I. The prolamines—Their chemical composition in relation to acid and alkali binding. *In* Holmes, H. N. (ed.): "Colloid Symposium Monograph," **2**, 209-368, illus.
- (18) Hopkins, F. G., and Dixon, M.  
1922. On glutathione. II. A thermostable oxidation-reduction system. *J. Biol. Chem.*, **54**, 527-563, illus.

- (19) Hunter, A.  
1925. Protein structure and proteolysis in some of their recent aspects. *Trans. Roy. Soc. Canada*, 19, Sec. V, 1-23, illus.
- (20) Johns, C. O., and Jones, D. B.  
1916. The proteins of the peanut, *Arachis hypogaea*. I. The globulins arachin and conarachin. *J. Biol. Chem.*, 28, 77-87.
- (21) Johns, C. O., and Jones, D. B.  
1917. The proteins of the peanut, *Arachis hypogaea*. II. The distribution of the basic nitrogen in the globulins arachin and conarachin. *J. Biol. Chem.*, 30, 33-38.
- (22) Jones, D. B., and Gersdorff, C. E. F.  
1923. Proteins of the cantaloupe seed, *Cucumis melo*. *J. Biol. Chem.*, 56, 79-96, illus.
- (23) Kendall, E. C., and Nord, E. F.  
1926. Reversible oxidation-reduction systems of cysteine-cystine and reduced and oxidized glutathione. *J. Biol. Chem.*, 69, 295-337, illus.
- (24) Lampl, H.  
1907. Über Desamidoedestin. *Monatsheft*, 28, 625-632.
- (25) Levites, S. J.  
1904. Über Desamidoalbumine. *Hoppe-Seyler's Z. physiol. Chem.*, 43, 202-206.
- (26) Levites, S. J.  
1909. Über Desamidoproteine. *Biochem. Z.*, 20, 224-230.
- (27) Lipka, J.  
1921. "Graphical and mechanical computation." Pt. II. Experimental data. 264 p., illus.
- (28) Lloyd, D. J., and Mays, C.  
1922. The titration curve of gelatine. *Proc. Roy. Soc.*, 93B, 69-85, illus.
- (29) Manabe, K., and Matula, J.  
1913. Untersuchungen über physikalische Zustandsänderungen der Kolloide. XV. Elektrochemische Untersuchungen am Säureeiweiss. *Biochem. Z.*, 52, 369-408, illus.
- (30) Mathews, A. P.  
1920. "Physiological chemistry," Ed. 3. 1154 p.
- (31) Mellanby, J.  
1905. Globulins. *J. Physiol.*, 33, 338-373, illus.
- (32) Michaelis, L., and Mendelssohn, A.  
1914. Die Wirkungsbedingungen des Pepsins. *Biochem. Z.*, 65, 1-15, illus.
- (33) Nakashima, R.  
1925. Über die Verdaulichkeit der Desaminoproteine durch proteolytische Fermente. *J. Biochem. (Tokyo)*, 5, 293-310.
- (34) Oryng, T., and Pauli, W.  
1915. Über Neutralsalzeiweissverbindungen. *Biochem. Z.*, 70, 368-397, illus.
- (35) Osborne, T. B.  
1892. Crystallized vegetable proteids. *Am. Chem. J.*, 14, 662-689.
- (36) Osborne, T. B.  
1902. The basic character of the protein molecule and the reaction of edestin with definite quantities of acids and alkalies. *J. Am. Chem. Soc.*, 24, 39-78.
- (37) Pauli, W., and Hirschfeld, M.  
1914. Die Proteinsalze verschiedener Säuren. *Biochem. Z.*, 62, 245-265, illus.

- (38) Plimmer, R. H. A.  
1917. "The chemical constitution of the proteins." Ed. 2. 174 p.
- (39) Reeves, G.  
1915. A new method for the preparation of the plant globulins. *Biochem. J.*, 9, 508-510.
- (40) Ritthausen, H.  
1880. Über die Eiweisskörper verschiedener Ölsamen. *Pflüger's Arch. für die gesamte Physiol.*, 21, 81-104.
- (41) Ritthausen, H.  
1881. Krystallinische Eiweisskörper aus verschiedenen Ölsamen. *J. prakt. Chem.*, 23, 481-486.
- (42) Robertson, T. B.  
1906. On the conditions of equilibrium of an associating amphoteric electrolyte in the presence of any number of non-amphoteric electrolytes. *J. Phys. Chem.*, 10, 524-582.
- (43) Robertson, T. B.  
1907. On the dissociation of serum globulin at varying hydrogen ion concentrations. *J. Phys. Chem.*, 11, 437-459.
- (44) Robertson, T. B.  
1908. Note on the applicability of the laws of amphoteric electrolytes to serum globulin. *J. Biol. Chem.*, 5, 155-161.
- (45) Robertson, T. B.  
1910. The dissociation of potassium caseinate in solutions of varying alkalinity. *J. Phys. Chem.*, 14, 528-568.
- (46) Robertson, T. B.  
1911. The dissociation of the salts of ovo-mucoid in solutions of varying alkalinity and acidity. *J. Phys. Chem.*, 14, 709-718.
- (47) Robertson, T. B.  
1920. "The physical chemistry of the proteins." 483 p.
- (48) Robertson, T. B.  
1924. The influence of hydrolysis upon the capacity of proteins to bind acids and bases. *Australian J. Exp. Biol. Med. Sci.*, 1, 31-37, illus.
- (49) Rona, P., and Michaelis, L.  
1910. Über die Fällung der Globuline im isoelektrischen Punkt. *Biochem. Z.*, 28, 193-199.
- (50) Sakaguchi, S.  
1925. Über die Bindungsweise und quantitative Bestimmung des Arginins im Proteinmolekule. *J. Biochem. (Tokyo)*, 5, 133-142.
- (51) Schmidt, C. L. A., and Hoagland, D. R.  
1919. Table of  $\text{pH}$ ,  $\text{H}^+$  and  $\text{OH}^-$  values corresponding to electromotive forces determined in hydrogen electrode measurements, with a bibliography. *Univ. Calif. Pub. in Physiol.*, 5, 23-69.
- (52) Schryver, S. B.  
1910. - On the action of salts in heterogeneous systems, and on the nature of globulins. *Proc. Roy. Soc.*, 83B, 96-123, illus.
- (53) Schryver, S. B., Buston, H. W., and Mukherjee, D. H.  
1925. Isolation of a product of hydrolysis of proteins hitherto undescribed. *Proc. Roy. Soc.*, 98B, 58-65.
- (54) Skraup, Z., and Hoernes, P.  
1906. Über das Desamidokasein. *Monatsheft*, 27, 631-652.



- (55) Spiro, K., and Pemsel, W.  
1898. Über Basen- und Säurecapazität des Blutes und der Eiweisskörper.  
Hoppe-Seyler's Z. physiol. Chem., 26, 233-271.
- (56) Takeda, M.  
1922. Über die Proteinverbindungen mit Säuren oder Laugen. J. Biochem.  
(Tokyo), 2, 103-115, illus.
- (57) Traxl, W.  
1908. Über Desamidoedestin. Monatsheft, 29, 59-68.
- (58) Van Slyke, D. D.  
1911. The analysis of proteins by determination of the chemical groups characteristic of the different amino acids. J. Biol. Chem., 10, 15-55, illus.
- (59) Van Slyke, D. D., and Birchard, F. J.  
1914. The nature of the free amino group in proteins. J. Biol. Chem., 16, 539-547.
- (60) Van Slyke, L. L., and Hart, E. B.  
1905. Casein and paracasein in some of their relations to bases and acids.  
Am. Chem. J., 33, 461-496.

1102

## THE EFFECT OF X-RADIATION ON A PLATINUM CATALYST IN THE SYNTHESIS OF WATER

BY P. H. EMMETT AND E. J. JONES\*

Several workers<sup>1,2,3,4</sup> have reported that irradiation of a Pt catalyst by x-rays markedly affects its activity toward various reactions. Schwarz and Friedrich<sup>1</sup> have observed that such radiation decreases the activity of a Pt catalyst toward hydrogen peroxide decomposition; Schwarz and Klinglefuss<sup>2,3</sup> have reported that it enhances the activity of platinized asbestos for the oxidation of SO<sub>2</sub> to SO<sub>3</sub>.

The present paper is a brief résumé of a study in which it has been found that x-radiation does not affect the rate of water synthesis in a hydrogen-oxygen mixture over platinized asbestos.

### Experimental Procedure

Each experiment consisted in passing a mixture of 97.2% O<sub>2</sub>-2.8% H<sub>2</sub> over a platinized asbestos catalyst and determining the fraction of the hydrogen catalytically oxidized into water, both before and after exposing the catalyst to x-radiation. The hydrogen-oxygen mixture used was prepared by permitting the products of an electrolytic cell to pass into a stream of tank oxygen that had been purified by passage over CuO at 400°C. The electrolytic cell contained platinum electrodes immersed in 30% KOH solution. It was operated to deliver about 2.15 cc. of hydrogen per minute. The oxygen flow was about 77 cc. per minute. The gaseous mixture passed through soda-lime and finally P<sub>2</sub>O<sub>5</sub> before being permitted to enter the catalyst chamber.

The catalyst tube was pyrex glass, drawn very thin to decrease the absorption of the x-radiation. .5 gr. of platinized asbestos containing .7% Pt was used. The catalyst tube was immersed in a water bath at room temperature.

The analysis of the gas for water vapor was accomplished by the well-known dew point method. The stream of gas to be analyzed was directed by a jet onto the polished surface of a nickel-plated can, whose temperature was accurately controlled by a circulating stream of water. The temperature at which dew formed on the can opposite the jet was a measure of the water vapor in the gas.

In each experiment the catalyst was first permitted to run to a steady state. Then the catalyst tube was closed off, placed near an x-ray tube, and

\* Bureau of Chemistry and Soils, Washington, D. C.

<sup>1</sup> Schwarz and Friedrich: *Ber.*, 55, 1090 (1922).

<sup>2</sup> Schwarz and Klinglefuss: *Z. Elektrochemie*, 28, 472 (1922).

<sup>3</sup> Schwarz and Klinglefuss: *Z. Elektrochemie*, 29, 470 (1923).

<sup>4</sup> Clark, McGrath and Johnson: *Proc. Nat. Acad. Sci.*, 11, 646 (1925).

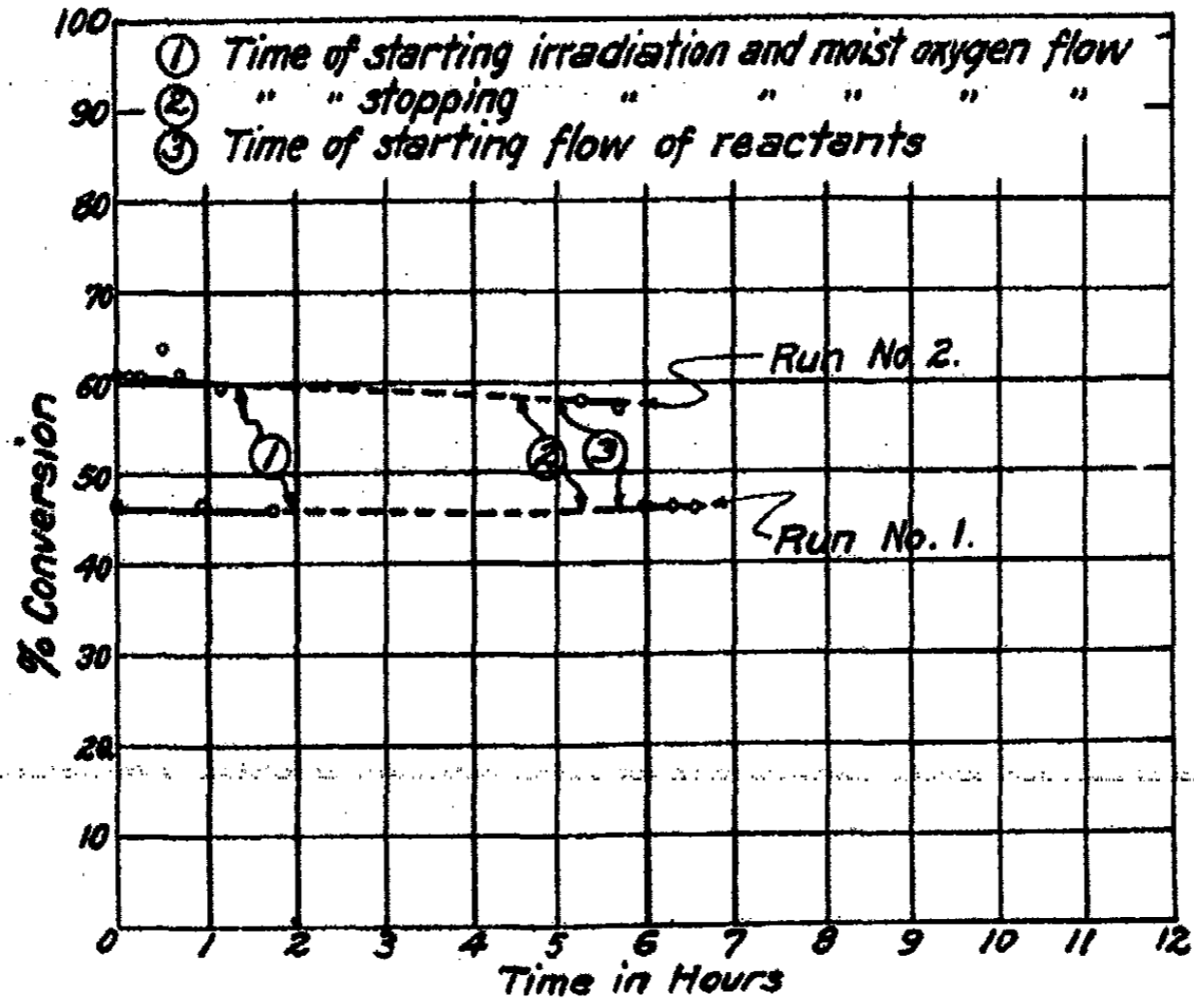

FIG. 1

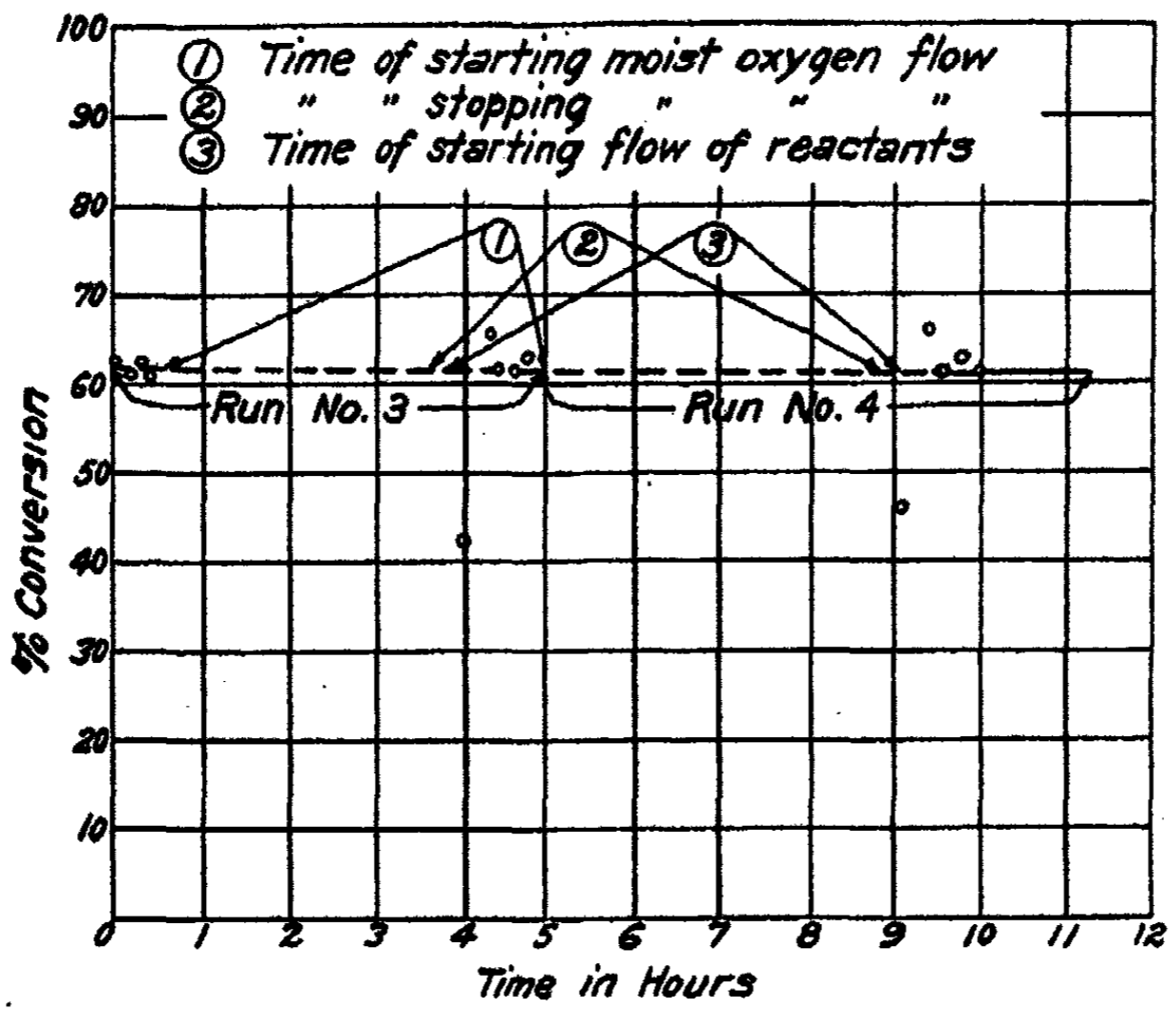

FIG. 2

connected to a source of humidified oxygen. After a three-hour exposure to x-rays in the stream of moist oxygen or, in the case of blank runs, to the stream of moist oxygen alone, the catalyst was connected again to the dew-point apparatus and hydrogen-oxygen supply and the activity of the catalyst again determined.

The x-radiation was that produced by a Coolidge tube with a molybdenum target operating at 30 K.V. and 10 milliamperes. The catalyst was placed about 9 cm. from the target.

#### Experimental Results

The radiation used was found to have no appreciable influence on the activity of platinized asbestos for the  $H_2O$  synthesis. The results of two of the runs during which the catalyst was subjected to x-radiation for three hours are shown in Fig. 1. In Fig. 2 are shown two blank runs obtained by passing the stream of oxygen containing .8%  $H_2O$  vapor over the catalyst in the absence of x-radiation.

It will be noted that in each blank run the very first reading after sealing the catalyst tube back onto the line is low. This apparently is due to a poisoning action of water vapor on the Pt catalyst. Unfortunately during the regular runs after exposure of the catalyst to x-radiation, readings were not taken quite so soon as on the blank runs and consequently these low points were not obtained. From the results as presented in Fig. 1 and 2, however, it can be concluded that any effect produced by irradiating the catalyst disappears within 20 minutes after starting the passage of hydrogen-oxygen gas.

Schwarz and Klingenfuss postulate that the enhanced activity of a platinum catalyst toward the oxidation of  $SO_2$  to  $SO_3$  results from the formation of a peroxide of platinum or at least the deposition of "active" oxygen on the catalyst. This, they believe, is due to the interaction of water vapor with the catalyst in the presence of x-radiation. They have experimentally detected the formation of some oxide capable of liberating iodine from an iodide solution.

From our results it would seem that if such an oxide is formed, it is either without influence on the reaction  $2H_2 + O_2 \rightleftharpoons 2H_2O$ , or that it disappears so rapidly as to escape detection by the methods used.

The Pt content of the platinized asbestos was considered too small to permit the detection of any activated oxygen by direct titration.

1-3  
**THE EFFECT OF TEMPERATURE ON THE STABILITY  
OF COPPER COLLOIDAL SOLUTIONS**

BY BEATRICE REID DEACON

**Introduction and Survey of Previous Work**

In the course of the last three years experiments have been carried out on the relation between the stability of copper colloidal solutions and their temperature. This paper contains the results of the investigations during the last year when somewhat more extensive work was done with one solution and results covering a greater range were obtained.

The results obtained in the previous work are as follows:—

1. There exists a critical temperature for a copper colloidal solution below which the sol does not coagulate due to heating and above which coagulation occurs. This temperature has been called the coagulation temperature.

2. When the time for which a given temperature is maintained is kept the same, the coagulation temperature decreases linearly with increasing concentration of added electrolyte, e.g. potassium chloride, that is, with decreasing charge on the particles.

3. When the time for which high temperatures are maintained, is varied with different samples of the same colloid the coagulation temperature decreases with increasing times of heating.

4. The curve which showed graphically the relation between coagulation temperature and times of heating tends to become asymptotic with the axis of time.

In the experiments presented herewith a freshly made colloidal solution was used. A greater number of results covering a greater range of times of heating were obtained. Further precautions were taken to ensure no change taking place in the stock solution during the progress of the work.

**Experimental Procedure and Results**

The experimental procedure has been described in detail in previous papers.<sup>1</sup> It is sufficient, here, to repeat that the colloid was placed in a copper tube, which was placed in a sealed glass tube. This tube was then placed in a glycerine bath (boiling point 290°C) which was heated electrically. The resistance of the colloid in the copper tube was measured, using two platinum electrodes, both before and after heating. These measurements provided a check on the introduction into the colloid of impurities which might affect coagulation.

A time of about 40 minutes was taken to raise the temperature of the glycerine to any desired point, using a current of 4 to 5 amps. The current was then reduced to a value that would just maintain the temperature required. After heating, the tube was removed and allowed to stand at room temperature for four hours. Then the glass tube was opened, the copper tube removed, and, after the resistance was measured, the colloid was poured into a cleaned and steamed test-tube and corked. At the end of an arbitrary

interval of twenty-four hours it was observed whether coagulation had taken place or not. The criterion of coagulation was the complete settling of the particles out of the suspension.

Two furnaces and two tubes were used in these later experiments. One tube was heated for a long time and simultaneously the second tube was heated for a short time. In this way determinations of the coagulation temperature were made at the same period in the history of the colloid for both a short time of heating and a long time of heating. Great care was taken in pipetting out the solution so that no impurities would be introduced into the stock colloid, which showed no apparent signs of coagulation at the end of the work.

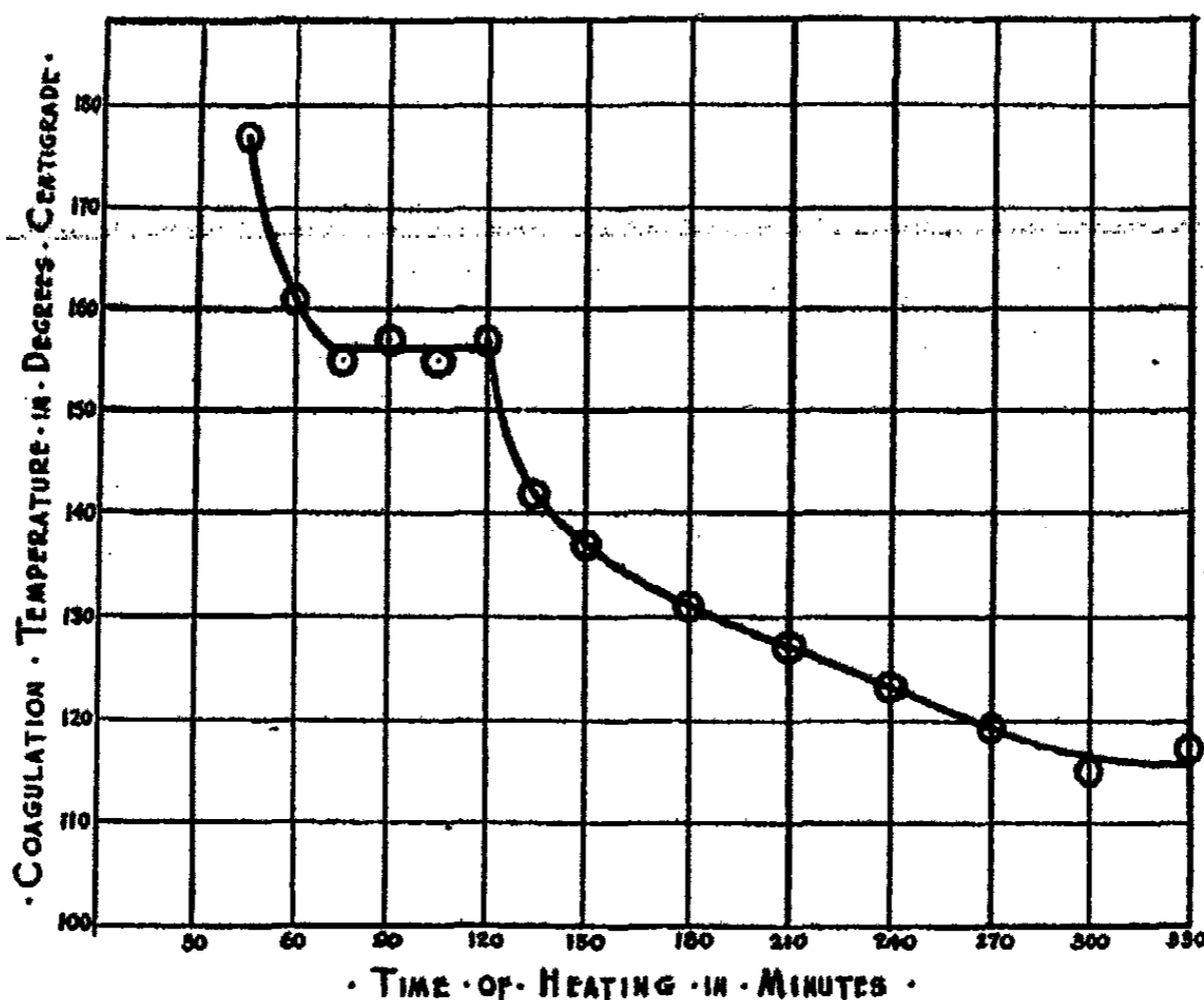

FIG. 1

It should be noted at this point that, as in the previous experiments, so in these, subsequent observation of the samples heated showed a consistent progress toward coagulation. Comparative observations were made at intervals of a week. For example, in determining the coagulation temperature corresponding to the time of heating of 60 minutes, samples of the colloid were maintained at different high temperatures for that length of time. One sample was heated to 155-156°C on Jan. 23 and was uncoagulated when the tube was opened. Slight coagulation was first observed on Jan. 31 and coagulation was not complete until Feb. 27. Another sample, heated to 159-160°C on Jan. 25, showed slight coagulation on Jan. 29 and complete coagulation on Feb. 13. For each solution similar effects were observed; those samples which were heated to higher temperatures coagulated in a shorter time than those heated to lower temperatures, when the time of heating was the same.

The shortest time of heating was 45 minutes for which the coagulation temperature was 177°C. The longest time of heating was 330 minutes, or 5½ hours, for which the coagulation temperature was 117°C. The results are given in Table I. The times of heating in minutes, as abscissae, plotted against the coagulation temperatures, as ordinates give the curve shown in Fig. 1.

The first and last parts of the curve show a decrease of coagulation temperature with increasing time of heating as was indicated before by the few results obtained with a different colloid. An asymptotic approach to the time axis is shown more definitely in this case than before. The horizontal portion of the curve is a surprising feature which does not find an explanation in the considerations which account for the general form of the curve.

TABLE I

Time of heating (minutes)	Temperature maintained (°C)	State 24 hours after heating	Coagulation temperature (°C)
45	177-178	coag.	177
	175-176	no coag.	
60	161-162	coag.	161
	159-160	no coag.	
75	155-156	coag.	155
	153-154	no coag.	
90	157-158	coag.	157
	155-156	no coag.	
105	155-156	coag.	155
	153-154	no coag.	
120	157-158	coag.	157
	155-156	no coag.	
135	143-144	coag.	142
	141-142	partial coag.	
	139-140	very slight coag.	
150	137-138	no coag.	137
	137-138	coag.	
	135-136	no coag.	
180	131-132	coag.	131
	129-130	no coag.	
210	127-128	great coag.	127
	125-126	no coag.	
240	123-124	coag.	123
	121-122	no coag.	
270	119-120	coag.	119
	117-118	no coag.	
300	115-116	coag.	115
	113-114	slight coag.	
330	117-118	coag.	117
	115-116	no coag.	

### Theoretical Considerations

The above experiments have to do with the destruction of the stability of a copper sol by the effect of increased temperature alone. The major part of the investigations on the coagulation of colloidal solutions have dealt only with the modification of the charge of the particle. These include the significant work of Linder and Picton,<sup>2</sup> Burton,<sup>3</sup> Hardy,<sup>4</sup> and Powis,<sup>5</sup> which demonstrates that the charge is the important factor governing the stability of colloidal solutions of the lyophobic type.

In the earlier conceptions of the condition of such a sol, the particle was supposed to be surrounded by the so-called Helmholtz double layer. It was thought that just outside the charged surface of a particle and within molecular distance of this surface there existed a layer of oppositely charged ions making up a total charge equal and opposite to that on the surface. As a result, it was maintained by some workers there could not be any mutual action between the particles.

Work of Gouy and later Milner, Ghosh, and Debye has established a different view of the double layer. The outer layer is now supposed to consist of an ionic atmosphere having an electrical density which falls off according to an exponential law.

Burton<sup>6</sup> has pointed out that this has an important bearing on the theory of the stability of colloidal solutions. He shows how an explanation is now provided for the mutual repulsion of particles, and for the effect of the addition of electrolytes on the stability of a sol. A picture is constructed of the mechanism by which added electrolytes bring about coalescence. Kruyt<sup>7</sup> also gives us a picture of the condition of such a sol and the manner in which its stability is destroyed:—

“We are dealing with colloid particles which are protected by the electric charge of the double layer against actual collisions. The particles are in a state of vigorous motion and approach one another repeatedly, but the spheres of their electric potential do not penetrate one another on account of their equal signs. These prevent the action of the superficial forces at the boundary of the particles and hence the particles cannot unite. The more the electric charge of the particles is decreased, the smaller the interference. If no charge were present each collision would result in a union. Under these circumstances the “probability of adhesion” of the particles, that is the ratio of the number of adhesions to the total number of collisions, would be one. In case the potential of the boundary layer possesses a certain value the collisions will, as a rule, be without results. Only particles that happen to have a high speed will be able to penetrate the repelling sphere and cause adhesion. (The average velocity depends, of course, on the temperature, but the numerical value of the velocity of a given particle is accidental in accordance with Maxwell’s distribution law). In that case the probability of adhesion will have a value between 0 and 1.

“The mechanism of flocculation is, therefore, determined by the *probability of collision and the probability of adhesion*. The former depends mainly



on temperature and concentration; the latter, in the case of suspensoids, obviously on the electric charge."

On the basis of this representation of the process it may be logically concluded that an increase of temperature of a colloidal solution, in which the particles bear a definite charge, will result in an increased probability of collision and also an increased probability of adhesion. The latter will follow from the increased number of particles having a sufficiently high speed to penetrate the repelling sphere possessed by other particles in virtue of their charge. Hence if a sufficiently high temperature is maintained for a sufficient length of time coagulation of the colloid is to be expected.

With a given time of heating it would be anticipated that the temperature sufficient to bring about complete coagulation should decrease with decreasing charge on the particle. This should be the case as a consequence of the fact that the minimum speed necessary for a particle to penetrate the repelling sphere must be lower, the lower the charge on the particle.

With a given charge on the particle it might be predicted that the coagulation temperature would decrease with increasing time of heating. Whether complete coagulation is effected or not depends on the number of collisions and adhesions occurring in a given time. For any particular time there should correspond a temperature at which a sufficient number of these takes place to effect coagulation in that specified time. If the time of heating is decreased and coagulation is to be produced, the rate at which collisions and adhesions occur must be increased, that is the temperature must be higher.

Smoluchowski<sup>8</sup> has developed a theory for the case where the probability of adhesion is one. This condition is attained when the charge on the particle is reduced to such an extent that it no longer interferes with collisions resulting from the Brownian movement. It may be reached experimentally by the addition of suitable electrolytes. Under such conditions we have so-called "rapid coagulation" of the sol. Some experimental tests have been made which tend to verify the theory. (see Zsigmondy,<sup>9</sup> Westgren and Reitstötter,<sup>10</sup> Kruyt and van Arkel<sup>11</sup>): In particular it has been shown that the radius of the "sphere of attraction" assumed by Smoluchowski to surround each particle, must be equal to twice the radius of a single particle. This means that collisions in which particles actually make contact are the only ones which result in coalescence. Further, the number of effective collisions proves to be just that number expected as a result of the Brownian movement if no opposing forces act. So Smoluchowski's theory of rapid coagulation, together with experimental results, offers direct support to the conception of the mechanism of the process outlined by Kruyt.

This theory has been extended by Müller<sup>12</sup> to apply to sols which originally consist of particles of different size. Wiegner<sup>13</sup> and Galecki<sup>14</sup> had already concluded, from measurements on milk and gold sols, that large particles act as coagulation nuclei for small particles. Müller provides a theoretical basis for the view that when large particles are present in a solution the small ones disappear very much more rapidly than they would otherwise do. If this is the case, then it is to be expected that the process of coagulation in any sol

must be accelerated as soon as a sufficiently large number of bigger particles has formed; the larger the number of big particles the more rapid the process of coagulation. Freundlich<sup>15</sup> refers to the fact that this effect offers a possible explanation of the autocatalytic progress of slow coagulation. This point is of interest in connection with the temperature experiments recorded above.

#### Discussion of the Results

The experimental results obtained are in agreement with the predictions made on the basis of Kruyt's representation of the process of coagulation. They offer, therefore, confirmation of it from a new point of view.

In the first place it was found that coagulation of a copper colloid may be brought about by increase of temperature alone. This is the fundamental fact which is in accord with deductions from Kruyt's picture of what takes place.

It was also found that when the charge on the copper particles is varied by the addition of different amounts of potassium chloride and the same time of heating employed, the temperature at which coagulation takes place decreases with decreasing charge. This means that with diminishing charge, smaller speeds of the particles are sufficient to produce coagulation in a given time. Again the agreement with the considerations above is evident.

Finally it is shown that the coagulation temperature decreases with increasing times of heating when the charge on the particles in each case is the same. That is, the rate at which union of particles occurs depends directly on the temperature; therefore if the temperature is lower the time for which it is maintained must be greater for complete coagulation to be effected.

These three results constitute evidence of the reality of Kruyt's representation of the process of coagulation.

In addition it is to be noted that the experimental curve becomes asymptotic with the axis of time. This indicates that at room temperature such a colloid as the one used might be expected to remain stable indefinitely. It must be concluded that the charge on the particles of the sol was great enough to prevent any appreciable number of effective collisions for increased speeds of the particles corresponding to temperatures up to 115°C. For any given sol of this type there will exist such a critical temperature. It will differ for different sols of course, since it depends on the charge on the particles which undoubtedly varies with each solution. It will also be different for sols of different concentrations since the number of collisions resulting from the Brownian movement depends on the concentration.

Mention has been made of the observation of subsequent coagulation in all the samples of colloid which were heated. This indicates that the heating results in a speeding up of the process of coagulation even though it may not be completed for weeks afterwards. From what has previously been said it is evident that multiple particles are formed during heating; the higher the temperature, the greater is the number of unions which take place in the same time of heating. It was observed that the higher the temperature, the shorter the time in which coagulation was completed. This fits in with the con-

clusions of Wiegner and Galecki, to which reference has been made, and with the theory of Müller, that large particles act as coagulation nuclei for smaller particles. It also makes plausible the suggestion that the subsequent coagulation is due to the presence of the larger complexes.

There is nothing in the considerations discussed, however, to account for the horizontal part of the curve. It certainly indicates that a singular condition of some sort exists in the solution at  $155^{\circ}\text{C}$ . Following the curve from low temperature to high there appears to be a change in the colloid to a less stable condition at  $155^{\circ}\text{C}$ . It seems reasonable to ascribe such a change in stability to a change in charge of the particles.

Now it is generally agreed that in the Bredig method of sparking wires under water to form a metal colloid some oxide of the metal is formed. The more active the metal, chemically, the more oxide is formed. In a copper colloidal solution then, a certain amount of oxide of the metal is present. One hypothesis as to the way in which such particles acquire a charge is that ionisation of the copper compound takes place at the surface of the particle.

On investigating chemical literature on copper and its compounds the following extract was found in Mellor's "Treatise on Inorganic and Theoretical Chemistry":<sup>16</sup>

"Cupric oxide is readily reduced by gently heating it in a current of hydrogen. During the reduction the mass sometimes becomes incandescent. J. J. Berzelius noticed that the action seems to begin at a definite temperature, which is lower the lower the temperature at which the oxide has previously been calcined. Thus, W. Müller-Erbach found that the oxide prepared by drying the hydroxide at  $300^{\circ}$  is reduced at  $135^{\circ}$ ; if the oxide has been preheated to a higher temperature, reduction occurs at  $140^{\circ}$ ; the oxide prepared by the direct oxidation of the metal is reduced at  $193^{\circ}$ , and that prepared from the nitrate is reduced at  $205^{\circ}$ . C. R. A. Wright and A. P. Luff found that precipitated cupric oxide washed and dried at  $130^{\circ}$  showed no signs of reduction at  $83^{\circ}$ , but at  $87-90^{\circ}$  reduction could be detected; with a sample prepared by ignition, no action could be detected up to  $170^{\circ}$ , but at  $175^{\circ}$  reduction was appreciable. F. Glaser gives  $150^{\circ}$  for the temperature at which reduction begins with oxide prepared from the nitrate; and  $199^{\circ}$  for powdered cupric oxide prepared by direct oxidation. The reaction has also been studied by A. Osaun, and by S. Hausch. According to R. N. Pease and H. S. Taylor the reduction of copper oxide by hydrogen is auto-catalytic, metallic copper being the catalyst. The reaction takes place at the copper-copper oxide interface. The presence of water vapour retards the formation of the copper nuclei but does not interfere with the subsequent action at the interface; oxygen has the reverse action."

Cupric oxide appears to be the more stable form of copper oxide at ordinary temperature and it seems reasonable to assume that in the stock copper colloid each particle has some cupric oxide associated with it. Then the explanation of the horizontal portion of the curve at  $155^{\circ}\text{C}$  may be that a reduction of cupric oxide to cuprous oxide takes place at that temperature. If the charge on the particle is connected with the compound of the metal

present, as suggested, then some disturbance of that charge is to be expected when there is a transition from one compound to another. It is thought that the horizontal part of the curve must be explained by some such change in conditions.

#### Conclusion

The conception of the mechanism of coagulation, which has been presented by Kruyt, is based on experimental evidence in so far as the effect of the charge of the particle on the stability of the sol is concerned. The process of so-called "rapid coagulation" is supposed to take place when the charge of the particle is reduced to such an extent that it no longer interferes with collisions resulting from the Brownian movement. The theory of rapid coagulation developed by Smoluchowski, together with experimental results, offers support to this picture of the process drawn by Kruyt.

The effects of temperature on the stability of sols, to be expected from this point of view, have been discussed. The results of the experiments detailed show that such effects have been found to exist for copper colloidal solutions.

It has also been noted that the effect of increased temperature in accelerating the process of slow coagulation is in harmony with theory and experiment in indicating that the presence of multiple particles is responsible for the increased rate of coagulation.

In addition, the conclusion has been drawn from the experimental curves obtained, that there is a definite temperature for each copper colloid below which it may be expected to remain stable for an indefinite time.

In conclusion, I wish to express my appreciation to Prof. E. F. Burton of the Department of Physics at the University of Toronto, for his suggestion of the problem and his invaluable advice throughout the progress of the work.

#### References

- <sup>1</sup> Reid and Burton: *J. Phys. Chem.*, **32**, 425-443 (1928); Burton and Deacon: "Colloid Symposium Monograph, pp. 77-82 (1928).
- <sup>2</sup> Linder and Picton: *J. Chem. Soc.*, **61**, 148 (1892); **71**, 568 (1897).
- <sup>3</sup> Burton: *Phil. Mag.* (6), **11**, 425; **12**, 472 (1906); **17**, 583 (1909); "The Physical Properties of Colloidal Solutions" (1921).
- <sup>4</sup> Hardy: *Z. physik. Chem.*, **33**, 385 (1900).
- <sup>5</sup> Powis: *Z. physik. Chem.*, **89**, 186 (1915).
- <sup>6</sup> Burton: *Colloid Symposium Monograph*, pp. 132-144 (1926).
- <sup>7</sup> Kruyt: "Colloids," pp. 66-67 (1927).
- <sup>8</sup> Smoluchowski: *Z. physik. Chem.*, **92**, 129 (1918).
- <sup>9</sup> Zsigmondy: *Z. physik. Chem.*, **92**, 600 (1918).
- <sup>10</sup> Westgren and Reitstötter: *Z. physik. Chem.*, **92**, 750 (1918); *J. Phys. Chem.*, **26**, 537 (1922).
- <sup>11</sup> Kruyt and von Arkel: *Rec. Trav. chim.*, **39**, 656 (1920); *Kolloid-Z.*, **32**, 29 (1923).
- <sup>12</sup> Hans Müller: *Zur Theorie der elektrischen Ladung und der Koagulation der Kolloide.*
- <sup>13</sup> Wiegner: *Kolloid-Z.*, **8**, 227 (1911).
- <sup>14</sup> Galecki: *Z. anorg. Chem.*, **74**, 174 (1912).
- <sup>15</sup> Freundlich: "Kapillarchemie," 604 (1922).
- <sup>16</sup> Mellor: "Treatise on Inorganic and Theoretical Chemistry," **3**, 135.

## AN IMPROVED PIRANI GAUGE\*

BY HERBERT G. TANNER

For the measurement of gas pressures below 0.5 mm. pressure the Pirani gauge has much to recommend it in spite of its limitations. The constructional requirements for a good gauge of this type are as follows:

- (1) The hot wire filament should be arranged to stay in one position.
- (2) Heat conduction along the leads or filament supports should be minimized.
- (3) Radiation losses should be minimized.
- (4) The volume of the gauge should be small.
- (5) The surface of the hot wire filament should be large.
- (6) The electrical measurements should be simple and rapid, and their accuracy should be consistent with other measurements.
- (7) The gauge must not enter into chemical reactions either catalytically or otherwise.
- (8) The temperature coefficient of resistance of the wire should be large.
- (9) It must operate on very little current in order that temperature effects in the measuring instruments shall be negligible.

With the above considerations in mind a gauge was constructed as follows:

The filament, with several millimeters of its leads attached, was removed from a 200-watt 240-volt Mazda bulb. This coiled filament was used for the filament of the Pirani gauge because it satisfied the above requirements No. 2, 5, 8, and 9, and indirectly helped to meet some of the other requirements.

The general shape of the bulb for the gauge was that used by Hale,<sup>2</sup> but of much smaller dimensions. The tubular bulb surrounding the filament was blown of Pyrex and was 6 cm. long and 1.5 cm. in diameter. The wall-thickness was approximately 0.5 mm. The filament lead stubs as clipped from the Mazda were spot-welded to tungsten wire leads 1.45 mm. in diameter. The filament was stretched over a glass post attached to the lead-in seal. The hair-pin shape thus given to the filament allowed the volume of the gauge to be minimized. At the place where the filament rested upon the glass post, the coils were straightened out so that the heat lost by conduction to the post was made very small. The tension of the filament maintained it in position, and therefore minimized the errors which would otherwise have arisen from thermal expansion, vibration, electro-static attraction, position of the gauge, etc., all of which affect the distance between the filament and the wall of the vessel.

Since the filament was comparatively long (approximately 188 cm.), the heat conducted out through the leads was proportionately small.

\* Contribution No. 27 from the Experimental Station of E. I. du Pont de Nemours & Company.

<sup>1</sup> Verh. deutsch. physik. Ges., 24, 684 (1906).

<sup>2</sup> Trans. Am. Electrochem. Soc., 20, 243 (1911).

The surface of the filament was approximately 236 sq. mm. The total volume of the gauge was 15 cc. The ratio of filament surface to total gauge volume was 15.7. In Hale's gauge the filament surface was 39.5 sq. mm. and the gauge volume was 92 cc. The ratio of filament surface to gauge volume was 0.43, but even this ratio is high compared to other gauges that have been described.

The resistance of the filament at room temperature was 20.4 ohms. In operation, the current was adjusted so that the filament resistance remained constant at 23 ohms. Its temperature therefore was approximately 50°C.

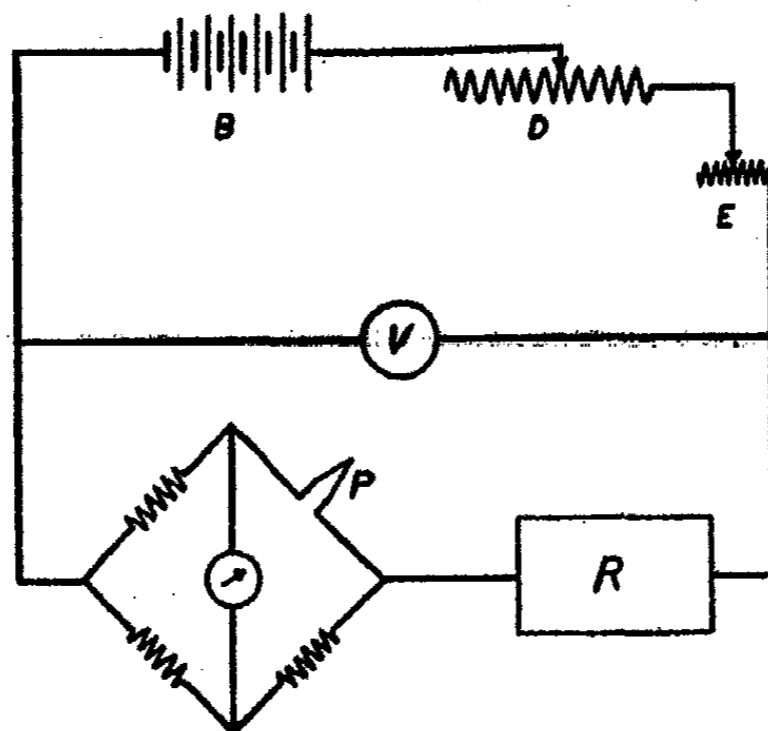

FIG. 1  
Diagram of Connections

This low temperature of operation has numerous advantages. Radiation losses are reduced, also the conduction of heat along the leads. Of even greater importance is the gain in chemical inertness. In the presence of electrolytic gas there was no oxidation of the wire, nor could any combination of the gases be detected over a period of several hours. As far as inertness from purely thermal considerations is concerned, this gauge is superior to the glass-mercury-thread gauge described by E. B. King,<sup>1</sup> and by G. K. Rollefson.<sup>2</sup> Lower temperatures than 50° could have been used, but the rate of attaining thermal equilibrium would have been slower. At a filament temperature of 50° and with the gauge submerged in an ice bath, about 20 seconds was required for equilibrium to be established at pressures around  $1 \times 10^{-2}$  mm.

The Pirani filament is usually made one arm of a Wheatstone bridge, and either the current flowing through it is maintained constant while the resistance is measured as a function of the pressure in the gauge, or the filament resistance, and therefore temperature, is maintained constant while some other electrical factor is measured. Pirani, Hale, and Stanley<sup>3</sup> preferred the

<sup>1</sup> Proc. Phys. Soc. London, 38, 80 (1925).

<sup>2</sup> J. Am. Chem. Soc., 54, 804 (1929).

<sup>3</sup> Proc. Phys. Soc. London, 41, 228 (1929).

former procedure. N. R. Campbell<sup>1</sup> pointed out some of the advantages of the latter method. He maintained a given bridge balance (constant filament temperature and resistance) by regulating the current flowing through the bridge, but instead of measuring this current for the corresponding pressures, he found it more accurate to observe the voltages across the bridge.

The chief disadvantage of Campbell's procedure is that the sensitivity rapidly diminishes as the pressure approaches  $1 \times 10^{-3}$  mm. If the voltmeter indicated pressures directly there would be much crowding at the lower end of the scale.

The following method allowed the "scale" to be spread out, thereby increasing the accuracy and the range of the instrument.

In Fig. 1, V is a sensitive voltmeter of 15-volt scale, reading directly to tenths of a volt. Its resistance is 1467 ohms. The resistance box R is adjustable by tenth-ohm steps up to 1000 ohms. The Wheatstone bridge is a Leeds and Northrup Type S Testing Set modified for external battery use. P represents the Pirani gauge. D is a 50-ohm rheostat, and E a 6-ohm rheostat. Together they permit accurate adjustment of voltage. B is a set of 5 dry batteries connected in series.

In calibrating the gauge, its resistance was calculated for 50°C., and the bridge set to balance this value. The gauge was then filled with gas at the highest pressure at which it was intended to measure. The resistances, R, D, and E, were adjusted while the bridge balance was maintained, so that the maximum current was limited to 100 milliamperes. Under these circumstances the voltage was 6.50.

Subsequently this voltage was maintained constant by the rheostats C and E, and the bridge brought to a balance for the various pressures in the gauge by adjustment of the resistance R. For calibration the readings of R were plotted against pressures indicated by a McLeod gauge, and a smooth hyperbolic curve was obtained. If the reciprocals of R be plotted against pressures, the major portion of the curve is a straight line.

A few typical data taken from the calibration curve for electrolytic gas are as follows:

R, ohms	McLeod pressures, $\times 10^{-4}$ mm.	R, ohms	McLeod pressures, $\times 10^{-4}$ mm.
25.2	1430	154.1	100
28.7	1250	201.0	43
36.0	1000	239.0	16
45.7	750	253.0	7
62.3	500	295.0	0.5

At  $1 \times 10^{-4}$  mm. pressure the gauge is sensitive to a 10% change in pressure. The lower limit of usefulness is about  $5 \times 10^{-5}$  mm. The sensitivity increases rapidly with increasing pressure. At  $1 \times 10^{-2}$  mm. the gauge is sensitive to a pressure change of 0.1%.

<sup>1</sup> Proc. Phys. Soc. London, 33, 287 (1921).

## NEW BOOKS

**Die Kolloide in Biologie und Medizin.** By H. Bechhold. Fifth, completely revised edition. 23 X 16 cm. pp. xiii + 686. Dresden and Leipzig: Theodor Steinkopff, 1929. Price: 32 marks; bound 35 marks. This is the fifth edition in name and the third edition in fact, because the so-called third and fourth editions were merely the second edition reprinted. The great change in the last ten years is that biology and medicine have begun to recognize the importance to each of colloid chemistry. Colloid-chemical and colloid-physical investigations now dominate the experimental research work on physiological and pathological processes.

The book is divided into four parts. The first part gives an introduction to colloid chemistry, with chapters entitled: what are colloids?; surfaces; particles, micelles, molecules, ions, dynads, individual groups; motion phenomena; optical and electrical properties of colloids; methods of research in colloids. The general subject of the second part is biocolloids and the individual chapters deal with: carbohydrates; lipoids; proteins; food and drink; enzymes; immunity reactions. The third part is concerned with the organism as a colloid system and the eight chapters have as headings; distribution and conversion of substances; form development and change, growth and development; cell and tissue; movements of organisms; blood, breathing, circulatory flow and its disturbances; respiration; secretions and excretions; nerves. The fourth part is devoted to toxicology, pharmacology, and therapy, and to microscopical technique.

"Chemical reasons indicate that albumin has a very high molecular weight. Even if we assumed that it was completely dissociated into single molecules in aqueous solution, these would still be so large that they could not pass through animal and vegetable membranes. The undamaged membranes of the organism therefore protect completely against loss of albumin. It is only in pathological states, such as disease of the kidneys, that albumin passes through," p. 2. Neuberg found that organic acids, such as benzoic and naphthenic acids, carried water-insoluble substances such as calcium carbonate, magnesium phosphate, insoluble soaps, dyes, fats, starch, hydrocarbons, etc., into apparent solution in water. He termed the phenomenon hydrotropy. There is no explanation as yet for this, p. 5.

Bechhold agrees with Mecklenberg that the differences in the stannic acids are structural differences and not chemical ones, p. 8. He quotes approvingly the conclusion by Martin Fischer that the green, yellow, orange and red colors of cuprous oxide are due to the sizes of the particles, the red ones being the coarsest. On the other hand he does not seem to know that Anderson's calculations of the pore sizes of gelatine are inaccurate, p. 11. Lecithin is an effective protecting colloid in chloroform, p. 12.

When the oil drops of an emulsion are  $0.4\mu$  in diameter, it takes 20 Atm. to force them through pores of  $75 m\mu$  in diameter. In one case an oil emulsion came through a collodion membrane clear under a pressure of 6 Atm. and cloudy under a pressure of 10 Atm., p. 17. Charcoal which has been shaken with the solution of a coal-tar dye often shows the green luster of the solid dye, p. 27. Unfortunately, Bechhold believes that the adsorbed dye is changed chemically, p. 28. Starch and coagulated albumin adsorb alkaloids strongly, p. 30. Bechhold attributes to himself and not to Pickering the fact that one can form emulsions with solid powders as emulsifying agents, p. 38. Clowes never said that emulsions were especially instable when the two liquids are present in equal volumes, p. 39. On p. 44 the author commits the common error of speaking of colloid molecules when he means colloid particles.

"We distinguish very often between molecular weight and molecular aggregate weight (or molar weight). For gelatine for instance, they have deduced a molecular weight of 850-1100 from the power to bind hydrochloric acid [which only gives a molecular weight in



case one assumes that gelatine is a monacid base], while the molecular aggregate weight is about 30000 from measurements of osmotic pressure and from similar methods. This means that about thirty single molecules are held together, perhaps by 'secondary' valences, in a larger complex (micelle). In general we can say that colloids are almost always dissolved as micelles," p. 47. This use of the word micelle is not at all that adopted by McBain.

Since people object to speaking of molecules in a sodium chloride crystal the author suggests calling the solid matter a dynad, p. 47. Perrin's calculations on gamboge solutions are apparently assumed to be accurate, p. 52. Urea increases the rate of swelling of gelatine, p. 56. The antagonistic action of salts is ascribed to the effect of the cations on the swelling of gelatinous colloids, p. 75. "All our experience indicates that the swelling and shrinking of hydrophilic gels runs parallel with the formation of ions and of neutral particles by albumin," p. 76.

"Quincke observed, in the artificial clearing of mastic, gamboge, kaolin, and ink suspension, that the flocks usually deposited on the shady side; with spontaneous clearing of kaolin suspensions on the illuminated side. With tannin and glue the precipitate forms mostly on the illuminated side. Quincke called this positive and negative photodromy," p. 85.

"L. Karszag has made a very important discovery which has been followed up by his students. He took a dye solution, Fuchsin S for instance, shook it with kaolin, let it stand for several hours, and then filtered. The filtrate was colorless. On adding hydrochloric acid to the filtrate, the solution became colored again. The dye had therefore been changed chemically by the kaolin. . . . Kaolin has therefore the property of converting the dye into the colorless carbinol," p. 101.

If this account is correct and if the dye was in the solution in the carbinol form, that can only mean that the kaolin adsorbed the hydrochloric acid and left the dye in solution. While that is interesting, it is not particularly thrilling. What would have been really interesting would have been for the kaolin to have adsorbed the fuchsin in the carbinol form.

"The best known reagent for starch is iodine, which colors it blue in the cold; the color disappears on heating. It used to be assumed that iodine formed a chemical compound with starch. The more recent investigations have proved conclusively that the blue iodine-starch is an adsorption complex, in which the iodine has diffused into the starch micelle to an amount which varies with the length of action.

"There are many other substances which give the iodine reaction, for instance lanthanum acetate [basic], saponarin (a glucoside), narcein, etc. Most convincing for the characterization of the iodine reaction are the phenomena with cholic acid. So long as this is in true solution, there is no color change. The blue iodine-cholic acid forms only when the cholic acid crystallizes or is precipitated as an amorphous mass, in other words when the molecules come together to form aggregates or micelles. . . . Other forms of starch are colored yellow by iodine, inulin, for instance, while glycogen becomes yellowish-brown to deep red. Cholic acid can also give a brown color with iodine, and, on the other hand, starch is colored brown by iodine in the absence of potassium iodide. Addition of certain salts, potassium iodide for instance, can change the color of starch-iodide to red or yellow. The colors of the starch and its degradation products with iodine is not due to the formation of a chemical compound but to an adsorption in which the color depends on the degree of dispersity of the substrate," p. 153.

"When cellulose is dissolved, in ammoniacal copper oxide for instance, the crystals remain but they are no longer parallel, and the X-ray diagram [of the precipitated fiber] indicates irregularly arranged crystals. This accounts for the lesser strength of artificial silk and for its unsatisfactory behavior when washed. It has now been found possible by drawing (as in wire-drawing), pressing, and stretching, to make the crystals in artificial silk lie a little more nearly parallel, thereby improving its properties," p. 157.

"Hattori was able to show that cholesterol forms an optically homogeneous colloidal solution in swollen lecithin. Water splits this into its components, lecithin and cholesterol, while physiological saline solution has no effect. Saponin coagulates swollen lecithin and breaks down the colloidal solution of cholesterol in lecithin," p. 161.

"Morgenroth and Pane heated cobra poison in N/20 hydrochloric acid and tested its haemolytic action immediately after neutralizing and cooling. The haemolytic action, as tested by means of lecithin, proved to have been decreased very much; but came back slowly in time (hours and days) to its original strength. It seems probable to me that this gradual return of poisoning power after neutralization is an ageing phenomenon. In the molecularly dispersed cobra haemolysin, particles clumped together gradually to form larger agglomerates with increased adsorbing powers," p. 220.

"Degradation products of albuminoids are poisonous to the organism and especially those formed in the higher organisms create symptoms very similar to anaphylactic shock and also similar physical changes in the blood," p. 236. The most general phenomenon of the later development of the organism, namely of ageing, is dehydration. Gels show it in a shrinking, a decrease of permeability for dissolved salts, and a decrease in elasticity. With sols, such as protoplasm, one recognizes it in a decrease of dispersity and of viscosity. There is also a decrease in the protective action. As people grow older, lime salts and urates precipitate more readily in the organism. It is also no mere accident that sicknesses, which act similarly on the body colloids, give the organism the appearance of extreme old age," p. 241.

"Under pathological conditions the water content of the organism may attain to much higher values than is normal. In severe anaemia the water content of the blood may increase ninety percent and more, while in diabetes the value may sink from 73.2 to 66.5%. In the case of *Diabetes insipidus*, there may be a flow of twenty or more liters of urine per day. Other organs may show abnormal swelling under pathological conditions. In fever, along with the intense conversion of organic matter into crystalloid products, there are also changes in swelling (thirst, dryness of the skin), about which we have little real knowledge.

"In general there has been less study of the cases in which swelling of the organs is less than the normal. Through injection of protoplasm poisons (many salts of the heavy metals, strong acids) a coagulation of the organic albumin may be brought about, whereby the swelling powers are decreased more or less. The most important factor for the distribution of water is the actual reaction of blood and tissue. In general one can say that alkalosis is connected with water retention and acidosis with a shrinking of the tissues," p. 251.

"Hoeber has suspended blood corpuscles in dilute isotonic solutions of different alkali salts and has observed the order which facilitates the coming out of the haemoglobin. The following order was obtained:  $SO_4 < Cl < Br$ ,  $NO_3 < I$  and  $Li < Na < C_2 < Rb < K$ . The order of the anions agrees pretty closely with the action of anions on lecithin; we must therefore assume that the alkali salts may peptize or coagulate the outer layer of the plasma, depending on the nature of the salt," p. 271.

"The permeability of living membranes for water and dissolved crystalloids is almost always different from inside to outside and from outside to inside. Our everyday experience teaches us that the skin, the intestine, and the lungs have a vectorial permeability. This has been shown very clearly by Wertheimer in his experiments on the skin of the frog. He took the skin off the legs and turned one inside out. He then filled both sacks with a solution of methylene blue. The dye passed readily through the skin from inside to outside, while no methylene blue passed in the opposite direction. With this arrangement it was possible to test all sorts of solutions. M/8 sodium chloride solution went through the skin from outside to inside, but not in the opposite direction. This was true of all sodium salts, while the other neutral salts passed equally readily in either direction. Strongly dissociated acids and bases do not pass in either direction, while the weak acids and bases show a vectorial permeability. This gives a simple explanation for the unilateral appearance of hydrogen and hydroxyl ions in organs (stomach, kidneys, and intestine). Amino-acids, polypeptides, and peptones pass from inside to outside. With grape sugar the direction depends on the concentration and salt content of the solution. By varying these, the flow can be reversed. Acid dyes go in the opposite direction to the basic dyes," p. 273.

"Porodko came to the conclusion that the tropisms in plants are due to coagulation of albuminoids in the cells in question. All substances were chemotropically active at the concentrations at which they salted out or coagulated albumin. In respect to positive and

negative chemotropism, it was possible to arrange the salts of the alkalies and of the alkaline earths in lyotropic series, similar to those which we have met so often in the precipitation of albumin and the swelling of gelatin, fibrin, etc. The heavy metal salts work more strongly and always to cause negative chemotropism," p. 324.

"The leucocytes do not move in a colloid-free medium; it is only when foreign colloids, such as gum arabic, gelatin, dextrin, or egg albumin are added, that the surface tension becomes low enough for them to be able to move. In the normal, colloid-poor, cerebrospinal liquor the leucocytes are also immobile; it is only in an albumin-rich, pathological liquor that the leucocytes move freely and actively," p. 325.

"Meigs has made a study of the nature of the semipermeable membrane around the fibrils. It is probable that this consists of calcium and magnesium phosphates. Celloidin membranes, which were impregnated with magnesium and calcium phosphates, proved to be impermeable to salts, sugars, and amino-acids; but were somewhat permeable to sodium chloride, glycerol, and urea and readily permeable to ethyl alcohol. They were also fairly permeable to potassium chloride, which seems reasonable. The assumption of a semipermeable layer of calcium phosphate would account well for two facts: (1) the disappearance of semipermeability after death (since the accumulating lactic acid would dissolve the membrane; and (2) the significance of calcium for maintaining semipermeability in living muscle. In a lime-free neutral solution a calcium phosphate film dissolves slowly," p. 333.

"According to Schade muscular rheumatism is to be considered as a change in the structure of the gel. Such an incapacitated muscle shows a decreased elasticity and an increased hardness which can be detected after death and even after the occurrence of the death rigor," p. 334.

"If one places frog muscles in an isotonic solution of cane sugar or any other non electrolyte (mannit, asparagin, etc.) they lose their irritability, for instance to induction currents, but retain their volume and do not swell as they do in distilled water in which the irritability also disappears. The power of contraction is restored by treatment with sodium ions (0.07% NaCl), and also by lithium ions but not by potassium ions," p. 338.

"It is very interesting to note what a tremendous effect pharmacologically active substances may have in the swelling of the serum proteins. Ellinger and Neuschlosz found that caffein may increase or decrease the swelling of the serum proteins depending on the concentration, with hydrogen ion concentration playing a decisive part. When the reaction is neutral (pH = 7.1), the maximum swelling occurs at a concentration of caffein of 1:118000, and a minimum with 1:8000. When the reaction is alkaline, (pH = 8.4), the maximum swelling occurs at 1:16000 and the minimum at 1:2000. This accounts for the very contradictory statements on the effect of caffein on the viscosity of proteins and on the cause of the diuretic action of caffein," p. 350.

"The frog never takes water through the mouth. He drinks through the skin. No swelling occurs during life because the kidneys keep eliminating the excess water. The skin is also permeable for lipid-soluble substances. The skin of the warm-blooded animals differs from that of the cold-blooded ones in that it is almost impermeable to water coming from the outside, and only lets lipid-soluble substances through," p. 374.

"Positively charged ferric oxide coagulates the negatively charged serum colloids and therefore intravenous injection of positively charged ferric oxide causes an animal to die of an embolism. Foà and Aggazzotti found, however, that the dog is not sensitive to an injection of positively charged ferric oxide; but nobody knows why. Fischer's negatively charged ferric oxide can be mixed in any proportion with serum. It forms a deep ruby-red solution, which may at times take up more than its own volume of oxygen," p. 443.

"Important observations have been made in recent years on iron in mineral waters. In the medicinal springs iron is present chiefly as ferrous iron ion in the form of ferrous bicarbonate. It is only when it comes in contact with the air that it goes over into colloidal ferric oxide, which colors the water brownish and causes the brown deposit. Today the majority of investigators incline to the view that ferrous ion and not ferric ion is the therapeutically effective form for the utilization of iron by the organism," p. 483.

Like several of the other German books on colloids, this one is a marvel as a compilation of facts. Like the others it is characterized by a conspicuous lack of theory. The Germans are falling farther and farther behind in colloid chemistry because of their failure either to develop a consistent theory or to accept one when developed by somebody else. This is so unlike what the Germans have done in the past that one wonders whether the war can possibly have brought about a temporary change in their point of view.

*Wilder D. Bancroft*

**Molecular Spectra and Molecular Structure.** *A general discussion held by the Faraday Society. 25 × 15 cm; pp. 338. London, 1929. Price: 15 shillings, 6 pence.* This volume forms another very timely addition to the general discussions on subjects of leading physico-chemical interest which have been organized and published by the Faraday Society. There can be few who are conversant with the very rapid progress and the amount of research recently published in the domain of molecular spectra, who will not welcome this attempt to present a summary of the salient lines of development by authorities in these different directions. The list of writers is international in its character, and it may be safely said that most of the leading authorities have made some contribution to the symposium.

The 38 papers have been placed in three Sections dealing respectively with Electronic Band Spectra, the Raman Effect, and Infra-red Spectra, and comment and criticism by those present is added at the end of each Section. Some of the various contents may perhaps be specially mentioned. Professor Richardson writes on the subject of Nomenclature, — a subject on which it is hoped that there will shortly be general agreement. Professor Mulliken writes on Band Spectra and Atomic Nuclei, and Professor Hund on Chemical Binding. Professor Birge writes on the Isotope Effect and on the determination of Heats of Dissociation. Professor Curtis deals with the Band Spectrum of Helium. Professor Raman writes on the Effect which his own brilliant researches initiated, and Professor Cabannes and other contributors deal with modes of excitation of Raman Spectra and the spectra of gases, liquids, liquefied gases, solutions, and crystals. Professor Schaefer introduces the discussion on infra-red spectra of solids. Dr. Lecomte deals similarly with liquids, and Sir Robert Robertson with gases. A very general summary of the whole work is presented by Professor Garner and Lennard-Jones.

It is scarcely possible to make detailed comment on a volume of this type. It inevitably lacks the unity of development and the coherence of a text-book, but has the compensating advantages of being up-to-date in every part and embodying the views of experts in their several subjects. It should prove a valuable addition to the libraries of physicists, physical chemists, and others whose researches are based on problems of molecular structure. The Faraday Society are to be congratulated on the enterprise and organization which it has involved.

*R. C. Johnson*

**Sulphuric Acid and its Manufacture.** *By H. A. Auden. 23 cm: pp. viii × 231. London: Longmans, Green & Co., 1930. Price: 16 shillings.* Mr. Auden's book is intended to help the ordinary student of applied chemistry to grasp the fundamental problems associated with the manufacture of sulphuric acid and by means of references to put him in touch with original articles when more detailed information is desired. In this connection it might have been useful to have mentioned somewhere the treatises of Lunge and the other detailed treatments of the subject which have appeared, not one of which seems to be referred to by the author. The treatment is clear and the amount of detail well chosen and there would seem no doubt that the book should prove useful to the type of reader mentioned who is willing to pay the rather large price of the book. In some cases the information is not at all adequate, as in the few words devoted to the use of ammonia oxidation. Fig. 31 is entitled "Glover tower", although the description seems to be of the Gay-Lussac tower. In the description of the contact process no mention seems to be made of the use of vanadium catalysts.

*J. R. Partington*

## CALORIMETRY IN FURNACES

9A-270.

BY WALTER P. WHITE

There is a growing interest in thermal data at high temperatures, and also a demand that specific heat measurements be made continuous over long intervals, in order to save time. The two chief general methods at present are: first, the "dropping" method, where the body investigated is heated in the furnace to one temperature after another, and each time dropped into a calorimeter at room temperature for the heat determination, a method which has given most of our really good data; and second, methods where the body is heated either electrically or by "radiation"—i.e. with all kinds of heat transfer—from the furnace wall, and the heat is found from a knowledge of either the electric energy or the heat transfer factor between body and furnace.

One experiment of this kind may cover the same ground as a whole series of "drops." This fact, however, has received rather more emphasis than it deserves. The amount of work to be done is not so great that it can not be handled by the dropping method, if that gives better results. More important appear to be the relative precision of the two methods, and the facilities they offer for giving protection from the air to oxidizable experimental materials.<sup>1</sup>

In the literature, the electric methods at high temperatures are, with one exception,<sup>2</sup> represented by little more than the suggestion that it might be a good thing to use them. The more numerous instances of radiation methods are too rudimentary to be of much use as guides. The ingenuity with which results of value have been wrung from very crude facilities is admirable, like the achievements of primitive man with stone hatchets, but the crudeness itself is not. In any fair consideration of the possibilities of furnace calorimetry the experimenter need not be supposed to be limited to one platinum-rhodium thermocouple, or even to two, and furnaces at least as elaborate as a modern aneroid calorimeter may be regarded as nothing extraordinary.

High temperatures lessen calorimetric precision in several ways. (1) Useful materials become more and more unavailable as temperatures rise. This limitation appears particularly in the growing difficulty of using fluids whose stirring equalizes temperature, and in the increasing clumsiness of electric insulation. (2) Uniformity of temperature in the surroundings of the calorimeter (i.e. the inner wall of the furnace) is harder to provide. (3) The rate of heat loss from the calorimeter is greatly increased. A good modern calori-

<sup>1</sup> Other conditions recommending or demanding the "radiation" method are given in Luke E. Steiner and John Johnston: Development of a method of radiation calorimetry, and the heat of fusion or of transition of certain substances. *J. Phys. Chem.*, 32, 938 (1928).

<sup>2</sup> The very interesting paper of Mlle. Hélène Roux: "Sur la Possibilité de la Calorimétrie adiabatique par voie électrique aux Températures élevées et son Application au Quartz cristallisé." *Lausanne Thesis*, 1923.

meter of the ordinary sort loses heat at a rate which if continued would bring it to the temperature of its inclosure in about 10 hours; the corresponding time at temperatures only moderately high may be 1 minute.

A contrast as enormous as this is due partly to the smaller sizes prevailing for calorimeters at high temperatures. But the increased heat conductance alone would be formidable; and small sizes are used only because they are preferable at high temperatures, so that the resultant large heat loss is usually inherent in the conditions.

The reason for small dimensions is as follows: The heat loss by thermal leakage is approximately proportional to the calorimeter surface, that is, to the square of the diameter. But the resulting rate of temperature change is proportional to the heat loss divided by the heat capacity, that is, practically, to  $D^2/D^3$  or to  $1/D$ . The heat loss is also proportional to the time, or inversely to the rate,  $V$ . Hence the thermal leakage error, which, other things equal, is proportional to heat loss, is proportional to  $1/DV$ .

But there is also an error from irregular temperature distribution inside the calorimeter, which acts in two ways, by falsifying the measurements of the temperature *changes*, and by making the determination of *surface temperature* less certain. These internal temperature differences are proportional to  $VD^2$ .

It is very easy to show that if we diminish the diameter of the calorimeter by dividing by a factor  $n$ , and at the same time increase the rate,  $V$ , by multiplying by  $n^{3/2}$ , we may diminish both errors, multiplying each by  $1/\sqrt{n}$ . Hence as long as the rate can be increased precision is improved by decreasing the size of the calorimeter. The rate of improvement is rather small, so that inconveniently small dimensions will rarely be worth while, but the advantage of larger size quite ceases as soon as ease of construction and manipulation has been secured.

When the limit of increase of rate has been reached the sum of the two errors is a minimum if the diameter is such that the external error is twice the internal.

It seems to be exceedingly difficult, however, to determine in a given case the ratio of the errors, either experimentally or by calculation. But it does not seem superfluous to say that the external error increases with irregularity of furnace temperature, so that a cruder furnace calls for a larger calorimeter, and the more the furnace is limited as to rate, also, the larger the calorimeter clearly should be. The internal error, somewhat proportional to  $VD^2$ , is greatly increased if the substance in the calorimeter is likely to shrink thru sintering or melting, and is larger if the material is a powder. Since the internal error increases as the square of the diameter, the external only as the first power, the presumption is against increasing the diameter blindly, and rather in favor of reducing it. That is, the calorimeter should be large enough to admit of easy construction, but no larger, until a knowledge of the errors indicates definitely that it should be.

(4) The enormous heat leakage rates and often, also, the changes occurring at high temperatures make it difficult to repeat a set-up, or even to maintain it, without changes in leakage rate or temperature distribution which are of more than appreciable magnitude.

*Special devices.* Several special devices may increase precision. **Internal radial vanes** of metal greatly increase the internal conductance of the calorimeter and contents. This diminishes the internal error, and this permits larger dimensions, which reduce the external error also. Unfortunately, the vanes are apt to interfere seriously with the insertion of electric heating arrangements at high temperatures.

**Twin calorimeters**, or what is known as the combination of specimen and "dead body," seem to have chiefly the advantage of automatically compensating or correcting for irregularities or variations in furnace rate. This makes them especially valuable for *detecting* small heat transformations, for which they have been most used. Their value in dealing with other uncertainties, such as those in furnace temperature *distribution*, will perhaps best be considered in connection with methods of observing. **Making the temperature measurement at the calorimeter wall**<sup>1</sup> instead of in the center of the experimental material, as almost always hitherto, evidently increases the precision with which the thermal head is known, tho it may diminish that of the mean calorimeter temperature measurement. Hence in determining specific heats alone this arrangement may not always be the best. It will very rarely be seriously disadvantageous, however, for the thermal leakage effect (connected with the thermal head) will be nearly or quite as large as the temperature rise (a matter of mean temperature), hence there is little to be lost by dividing the precision of the one in order to multiply that of the other. But whenever a large change of state occurs, or whenever electric heating is used, the external measurement has an advantage which is unquestionable and very great. For at such times, under conditions generally prevailing in high temperature work, a thermometer in the center of the calorimeter is useless to measure external temperature or mean temperature either, while a thermometer properly attached to the wall will still show the external temperature fairly well; when the uniform conditions have returned it is at least an even chance that the external measurement will be better. Hence the external measurement is sometimes absolutely necessary, and nearly always sufficient. It is seldom worth while to add another thermometer in the center unless melting or inversion *points* are to be determined. But this is not calorimetry.

If the temperature reading is by a thermocouple the two wires may be separately welded to the calorimeter wall. In that case there will usually be a small temperature error, equal to a few per cent of the thermal head. This systematic error will usually be almost entirely compensated or canceled by calibration or in twin methods. The error can be avoided, where platinum calorimeters are used, by making the calorimeter wall out of the two thermoelectric metals, platinum and platinum-rhodium. The joint between the two

<sup>1</sup> Walter P. White: Am. J. Sci., 28, 486 (1909).

can run around the calorimeter, thus giving a closer approach to the average temperature of the whole surface, since their line of contact constitutes most of the junction, thermoelectrically. It should do no harm to have a little of the junction come where the wires are welded to the surface, so that it is not imperative to have the wires closely resemble the wall in thermoelectric quality. It is desirable to have the different paths in the metal wall from one wire to the other all of about the same resistance, since the temperature along a shorter path will have an undue influence on the resultant thermoelectric

force. Fig. 1 shows a good arrangement.

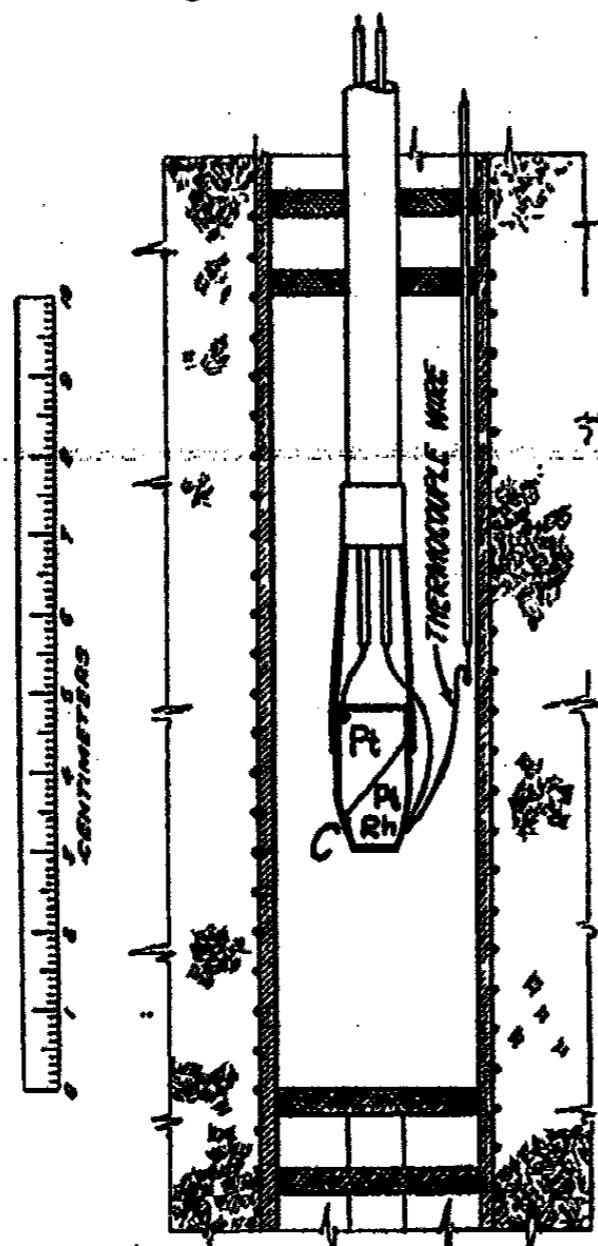

FIG. 1  
Calorimeter with wall-thermel, arranged for reading against a furnace thermel. Pt, platinum portion of the calorimeter wall, P-R, platinum-rhodium portion.

force. Fig. 1 shows a good arrangement. Contamination of platinum thermocouples is especially serious in this kind of calorimetry. This contamination is always by far the greatest in the hottest parts of the furnace, and is relatively small in the cooler portions, the average contamination over the whole gradient, on which the error of reading ordinarily depends, thus being much less, perhaps a fifth to a tenth, of that at the inner end of the couple. But in the methods of calorimetry considered here, the vital thermal head measurement, a differential reading, depends upon wire wholly within the hottest portion, and therefore at maximum contamination. The contamination error of this measurement, therefore, is five to ten times as great as that which would ordinarily characterize a given thermocouple, or be indicated by the usual tests. This suggests that contamination error should be watched with especial care in furnace calorimetry, and also that at higher temperatures, say above  $1100^{\circ}$ , where contamination is more rapid, methods should be used with which the systematic error of the

thermel<sup>1</sup> cancels. These may be (1) *repetition* or *substitution* methods; i.e., methods in which a known, standard substance alternates with an unknown, and both are made to have nearly the same temperature curve, so that the error, tho' present, is eliminated when the two curves are compared; and (2) methods where the thermal head reading is near zero, and its proportional error, therefore, is negligible. These latter may be twin methods, where the two calorimeters are at practically the same temperature; or methods where electric heating keeps a single calorimeter close to the tem-

<sup>1</sup> Thermel, thermoelectric thermometer, here usually a thermocouple.



perature of the furnace thermocouple. In this latter case the contamination error will be near zero<sup>1</sup> when the reading is zero.

*Electric Heating* is of great value. It can advantageously be presented in connection with the description of methods of observing.

The simplest *plan of observing* that is worth mentioning has a single calorimeter, and calls for two thermocouples, one on the calorimeter, the other near the furnace wall, as in Fig. 1. Unless something interferes, which will rarely tho sometimes be the case,<sup>2</sup> these couples should be joined so as to be read differentially, giving the thermal head directly. This ordinarily does not interfere with reading either of them singly, also. To calculate the thermal head from the necessarily non-coincident separate readings of furnace and calorimeter is relatively inconvenient and laborious, and usually quite needless.

The thermal head readings, multiplied by an appropriate factor, which we may call  $K'$ , give the heat added to the calorimeter from without, or the heat lost, if the furnace is cooler. The temperature change in the calorimeter is the only other thermal datum needed. Hence readings of the thermal head (at frequent intervals) and of the calorimeter temperature (not necessarily so often) are all that is absolutely required. The taking of them is so easy as to be rather monotonous.

The "furnace" thermel, however, will seldom give the effective temperature of the furnace at all exactly. If  $\varphi$  is the thermal head as read, the true head is  $\varphi + x$  where  $x$  is the temperature difference between the furnace thermel and the mean effective temperature of the furnace cavity, including the ends, usually much colder than the middle. Hence if  $\varphi$  is doubled the true head is usually not doubled. Satisfactory precision, therefore, by this method, generally demands making it what may be called a repetition, comparison, or substitution method: that is, the form of temperature-time curve is reproduced in such a way that the unknown  $x$  also is not altered. Then the supply of heat to the calorimeter is duplicated and may be known if one set of determinations is made on known material. This will nearly always be possible in determining heat capacities only. Small differences in specific heat may then be compensated by taking different quantities of material. Or else the small differences in  $K'$  due to slightly different heat capacities can usually be evaluated as well as is worth while, considering the size of the accidental errors, since  $x$  can hardly be any large fraction of  $\varphi$ , so that the small differences in  $\varphi$  corresponding to small differences in  $K'$  are accompanied by negligible differences in  $x$ . This method evidently calls for good control of the furnace rate.

With latent heats of any magnitude the method becomes less satisfactory. Its success depends primarily on rather exact reproduction of conditions, both as to size of thermal head and as to furnace rate. It also calls for a standard

<sup>1</sup> If the wires running out of the furnace differ in amount of contamination, however, there will of course be an error.

<sup>2</sup> Electric leakage within the furnace is the thing most likely to interfere.

substance of known thermal properties. Now in determining specific heats, substances are already available whose specific heat is known over a wide temperature range, and these can be immediately used for any desired temperatures. But standards of latent heat, that is, melting substances, are necessarily available only at isolated temperatures, and hardly any are just now available at any high temperature at all. And if the attempt is made to compare known specific heats with latent heats the furnace rate or the thermal head must be enormously different for the two. For the amount of heat required to melt most substances at 1000° or over is as much as will raise their temperatures 300° when no melting is taking place. If the furnace rate is kept constant the furnace runs far above the nearly stationary temperature of the melting substance (or below in a cooling curve), the thermal head varies to values twenty-fold or more greater, and the effect of the uncertain thermal-head-difference which we have called  $x$  is correspondingly magnified, and also distorted out of all calculation. If, instead, by skilful regulation of the furnace the thermal head is kept constant, the rate must be greatly changed, and with it the quantity  $x$ , and the time of melting is enormously extended, to 30 minutes or more, with corresponding increase of important accidental errors. Even with heating as slow as this the ratio of thermal leakage to heat determined will not be larger than in finding specific heat, but the opportunity to make it much smaller will be wasted.

*Electric* heating of the melting charge provides a complete escape from this difficulty. The whole melting can usually be done in 3 minutes, about the time often taken for heating an unmelted sample 30°, or (for silicates) 10 calories per gram. If the latent heat is 100 calories per gram, the total heat supply from the furnace is likely to be only about 10 per cent of that supplied, and measured with high accuracy, by the electric heater. The important thermal leakage error, therefore, will tend to be only a tenth as great when electric heating is used. On the other hand, the electric heater may be so located as to cause irregularity of external temperature, and this effect may be very serious. Further work will be necessary to say how serious. The effect will depend greatly on the experimental material, as well as on the arrangement of heater and calorimeter. One very serious case of it is illustrated in Table II. Electric heating augments the manipulation, but this does not in the least condemn it where it is otherwise successful. The heater almost prohibits heat-conducting vanes inside the calorimeter, so that higher precision may be attained without it in some cases of specific heat determination.

Twin Calorimeters, as already pointed out, diminish very greatly the difficulty and uncertainty of furnace regulation, whenever the two calorimeters can be kept at nearly the same temperature, and this seems nearly always a sufficient reason for using them. They will usually not avoid the need for substitution or repetition methods, since entire similarity of the two calorimeters can not be assumed. The procedure will be, not simply to put the standard substance in one, the unknown in the other, but to alternate known and unknown in one, against an unchanged substance, preferably the

known, in the other. (Reversals are also possible.) Such a procedure has this further advantage over the substitution method with a single calorimeter, that the error associated with the thermal head is now no longer due to the thermal head itself, but to the very small difference in the thermal heads of the two calorimeters.

In general, then, for *latent heat* determination the twin calorimeters with electric heating promise to be sometimes the best arrangement. *Specific heat* determination offers several interesting methods. (1) For running up continuously with the furnace, the method generally contemplated by those who commend furnace calorimetry, there seems to be no doubt that the twin arrangement, largely compensating the temperature difference  $x$ , as well as some lags and other irregularities, is nearly always quite the best. Electric heating may have some advantages, but hardly seems worth while for specific heat work alone.

Every specific heat determination by the twin method necessarily includes a comparison of the heat capacities of the two calorimeters; only the difference is actually measured. And since specific heat can usually be determined more accurately by the dropping method than by experiments wholly within the furnace, and since a number of specific heats have thus been determined and can be utilized in comparison methods, there will usually be no need for determining any specific heats absolutely in the furnace. But sometimes this may be desirable, and three different methods for doing it have the interest of novelty, since each has rarely, if ever, been used outside of a furnace. All use electric heating as a source and measure of heat.

(1) The comparison calorimeter is used, but is left empty. Then heat flow from the furnace heats both calorimeters alike, that is, the walls of each, while the electric heat all goes to the unknown substance filling one. A correction is of course necessary for the difference in heating from the furnace, as measured with both calorimeters empty. It is necessary that the heating from the furnace should not be changed by introducing the filling of unknown substance; since most materials have a radiating power different from that of the metal wall, this necessitates covering the calorimeter rather thoroughly, a troublesome, but not at all prohibitive, task, and one which, as will appear later, seems indispensable with all electric heating. This appears to be the only possible way of determining a specific heat by the twin method without introducing another specific heat. I regret not having tried this promising method. It practically demands thermels in the calorimeter walls.

(2) A single calorimeter is heated electrically, with stationary furnace, until equilibrium is reached, and the rate of heat supply and the temperature elevation are measured. This gives the emissivity, or coefficient of heat loss. Then the heat is shut off, and as the calorimeter cools down to the furnace, measurements of its temperature give a series of values of the cooling factor, which is the emissivity divided by the heat capacity. The first quantity divided by the second is the heat capacity, when proper units are used. This method is reported on later.

(3) With furnace stationary a single calorimeter is heated strongly for a short time, say a minute, and then allowed to cool again and its temperature is read at very frequent intervals (5 seconds, say) both up and down. The cooling gives the rate of temperature loss as a function of calorimeter temperature, and from it the total temperature loss during the heating can be found, and added to the temperature rise. This method is thus essentially the same as the one generally used for larger calorimeters at ordinary temperatures. Like that, it assumes a constant surrounding temperature. In principle, it is quite the same as a very old method, where, after the temperature rise, the calorimeter was brought successively to various temperatures in order to determine the variations of heat-loss factor over the whole range covered. This usually very tiresome method has long been abandoned in favor of methods where the heat loss is calculated from a few observations by reliance on Newton's Law of cooling. In the furnace, however, where two-thirds of the range may be retraced in a minute, the method is rapid, besides avoiding some errors.

#### Experimental

Observations were made to determine some of the possibilities of the above methods. That electric heating could easily be made adequate in amount was clearly shown. A platinum wire 0.1 mm in diameter and 20 cm long was wound in a helix which, bent into a U, was easily inserted in a very small platinum calorimeter 1 x 1.5 cm. A silicate powder was filled in. At 1230°, 6.7 watts in the coil, energy sufficient to melt the silicate in less than 3 minutes, heated the wire only about 162° above the wall of the calorimeter. Hence it appears that such a heater could often be effectively used up to 1500°, and fairly well at 1600°. If the experimental material melts, however, to a liquid which is not highly viscous, the heater, if a coil of fine platinum wire, is likely to sag hopelessly at temperatures much above 1200°.

The thermal leakage rate was determined by over fifty experiments, as shown in Table I. The general furnace temperature was in all cases held constant by a Geophysical Laboratory furnace temperature regulator. The calorimeters and furnace were not readjusted or touched in any way during the series. Twin calorimeters were used, and the difference between them was used as the measure of the thermal leakage rate.

The *temperature coefficient* would doubtless be somewhat different for other installations, but a knowledge of its value for any system seems interesting. Here there was platinum, with a small surface of silicate exposed at the top, sending heat to an alundum tube 28 mm internal diameter. The values followed, well within the limits of the experimental error, from 300° to 1200°, the equation:

$$\frac{\text{Watts}}{\delta\theta} = 0.0139 + 0.00696 e^{0.0026\theta}$$

The small, apparently negligible, effect on the thermal leakage factor of the amount of thermal head (i.e. temperature difference between sending

TABLE I  
Temperatures and heat flows. Equilibrium conditions

Serial numbers of the experiments	Total number of experiments	Mean temp. of the two calorimeters	Temp. diff. of the two	Excess temp. of heating coil	Ratio, watts ÷ temp. diff. of calorimeters		Ratio, watts ÷ excess temp. of heating coil	
					Average	max. and min.	Average	Max. and min.
52-56	5	300°L	40°	—	0.0298	0.0296	—	—
1	1	400	40	52.3	.0334	.0300	.0269	
47, 50, 51	3	400L	40	.58	.03005	.0360	.02583	0.0252
2	1	400	80	101.3	.0331	.0361	.0261	.0264
7-19	13	600	40	68	.04783	.0477	.02815	.0280
5, 6, 20, 21, 22	17	600	80	139	.04792	.0475	.02782	.0270
34-45	1	800	40	84	.0716	.0701	.0314	.0288
3	5	800	40	85	.0703	.0707	.0304	.0300
23-27	2	800L	40	105	.0821	.0819	.0309	.0308
48, 49	7	800	80	169	.0707	.0823	.0306	.0314
4	1	1211	37	189	.0696	.0694	.0295	.0294
28-33	1	1211	37	—	.181	.0699	—	.0297
46	1	1211	37	—	.181	.0699	—	.0297

REPRODUCED FROM THE NATIONAL BUREAU OF STANDARDS MONOGRAPH COLLECTION, MONOGRAPH NO. 10, 1926, PAGES 1129-1130.

and receiving surfaces) is surprising and important, since the sizes of the air gap and of the thermal head were sufficient to cause very decided convection at ordinary temperatures, and convection makes the thermal leakage increase more rapidly than the thermal head. No doubt a careful consideration of the conditions would explain the apparent anomaly.

The discrepancies, which in regular determinations might become errors, seemed especially worth investigation. To this end the voltage and current observations which gave the energy were combined to find the resistance of the coil, and the coil temperature was calculated from this and compared with the calorimeter wall temperature, as also appears in Table I.

During the observations there were continual slight fluctuations in the current and voltage readings, due no doubt to convection currents which affected the temperature of the heater wire. These appear to be the chief cause of the small accidental errors in Table I, a conclusion quite consistent with the relative size of such errors in columns 7 and 9. Drifts of the temperature measured by the thermocouple were present, but generally less important. These errors, in themselves, are not large enough to prevent furnace calorimeters from having all the precision which would ordinarily be expected of them.

The difference between different groups of experiments, however, is another matter. The latest ones, marked L, were done after the calorimeters had been heated for 5 or 6 hours at  $1200^{\circ}$ , a temperature which caused marked sintering of the silicate powder. The coil now runs much hotter, for the same number of watts, showing poorer thermal contacts with the experimental material. At the same time the watts required to maintain the calorimeter at a given excess temperature were very considerably increased, indicating that a good deal more of the heat now escaped to the air, without reaching the calorimeter wall. (An increase in total rate of heat loss would have produced this effect, but such an increase will be shown not to have occurred.) These results seem to show very clearly that transferring all the electric heat to the calorimeter is one of the most crucial points in this kind of calorimetry. It is much easier when the experimental material can be melted into a solid cake; but much harder where the material has electrolytic, or high ohmic, conductivity.

The calorimeter had previously been heated for a few hours to  $1200^{\circ}$ , and the charge of experimental material had hardly been touched meanwhile. This makes the change from sintering seem more striking, since it was only the second sintering. A calorimetric experiment showed an inappreciable amount of melting at  $1200^{\circ}$ .

Four experiments were tried where the calorimeter, at first in equilibrium with the stationary furnace, was heated 4 minutes and then allowed to cool. Measurements were made of the energy supplied, and of the integrated thermal head over the whole time. These measurements are essentially the same as those in Table I, except that they apply to changing calorimeter temperatures. The agreement with Table I was in part exceedingly close.

Some small systematic errors may have cancelled each other. The essential thing is that the disagreement with Table I ranged from 0.6 per cent to 5. per cent.

The second specific heat method described above, that of comparing the heat loss at constant temperature with the cooling rate, was tried by running 22 cooling curves and comparing with values from Equation (1). This method has two general sources of error. (a) When the heat is first turned off the interior of the material in the calorimeter is very much hotter than the calorimeter wall, where the temperature measurement is made. Hence the fall of temperature of the wall will at first be less than corresponds to the

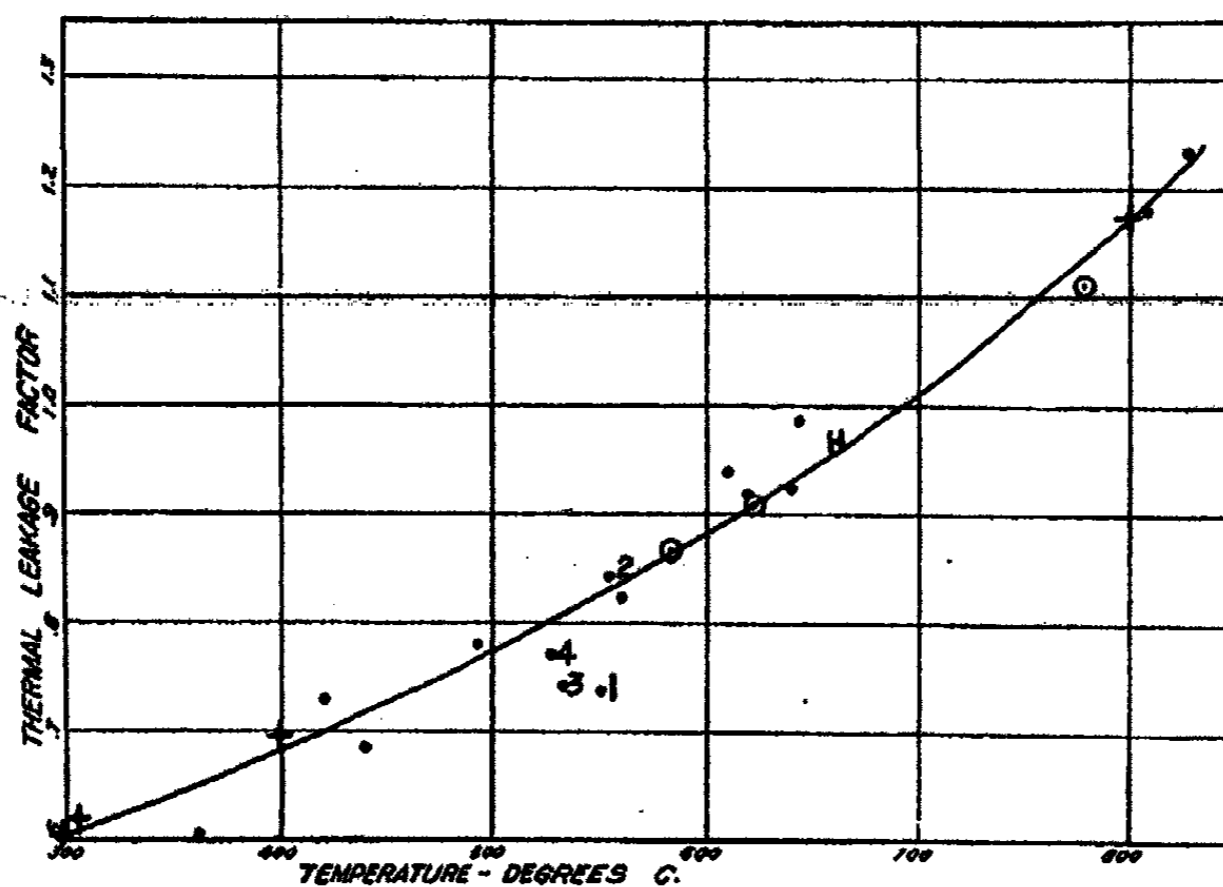

FIG. 2  
Thermal leakage factors, determined by rapid cooling; H, one point determined by rapid heating.

heat emitted from it; the first part of the curve will not give the true emissivity. (b) The equilibrium temperature toward which the calorimeter is cooling is usually slightly uncertain, and a very slight uncertainty in it is several percent of the change per minute in the calorimeter toward the end of the cooling. Probably the best results call for a very high heating of the calorimeter, so that internal equilibrium will be sufficiently reached before the cooling rate falls to a very small value. Small dimensions of the calorimeter help against both errors, since the internal equilibrium is accelerated more than the cooling, and the disturbance of furnace, that is, zero, temperature by heating the calorimeter is less. But here, as elsewhere, the effect of moderate changes in dimensions is not very important. The effective part of the cooling was from 3 to 5 minutes in our experiments, where the rise was usually not over 40°.

A second calorimeter is a detriment in this particular determination, hence our observations were used only to test the consistency of the results. The cooling curve results are shown in Fig. 2. The observed values of each run

were smoothed, where this seemed desirable, but the change needed was seldom over  $0.1^\circ$ , or the precision with which the temperatures were recorded. At the higher temperatures this was over a percent of the change per minute in the most valuable part of the curve.

The upright crosses (+) show the later results, obtained during the work for Table I, when the furnace was left untouched. These later results agree very well with each other, and lie close to the curve which is the mean of all the observations. Such of them as precede the sintering at the second heating to 1200 are undistinguishable from those obtained after it. This is the reason for saying that the external conductivity did not change perceptibly during the work for Table I. Point No. 1 was obtained after the calorimeters had been lowered about 3 cm. in the furnace. Nos. 3 and 4 came just after No. 2, but the calorimeters had been removed and replaced meanwhile. The dots show still earlier results. Their discrepancies have not been explained, but do not seem to invalidate the conclusion which would follow from the later results, namely, that with a little care and experience it should be possible to keep the thermal emissivity constant to 2 per cent, and usually better than that. Since the thermal leakage factor is of the order of 1 per minute, this precision apparently would correspond in calorimetric determinations to a precision, as far as thermal leakage is concerned, of 2 per cent per minute of the thermal head, or of its uncertainty when it is small, as in twin or approximately adiabatic methods.

The third method mentioned above is essentially a typical calorimetric method of applying heat and measuring the temperature rise and the heat loss, but it has several peculiarities. When current was turned into the heating coil the rate of temperature rise began to fall off in from 20 to 40 seconds, so that the most favorable ratio of temperature rise to time called for a very short heating, seldom over a minute, probably. In this short time it was not possible to read adequately all the necessary quantities; the heating current, its voltage, the calorimeter temperature, and the furnace temperature, which was very appreciably altered by heating the calorimeter. Hence it seemed necessary to keep repeating the heatings, measuring one quantity each time and letting the calorimeter cool after each run. This did not make the whole experiment very long, only from 60 to 90 minutes, and the repetitions of each kind of reading were so close that no important error was likely to result from not reading the different quantities in the same run.

When the heating current is first turned off the center of the material in the calorimeter is much hotter than the wall, where the temperature is measured, and it at once begins to discharge heat to the wall. Hence the cooling rate observed at first is not the true cooling rate for the observed thermal head, and cannot be used to calculate the heat loss. The true rate can be found by two methods, both of which might be used. It can be calculated from the more normal later rates at smaller thermal head; or it can be observed by heating the calorimeter so high that the cooling is normal when the calorimetric range is reached.



Even if the cooling is "normal," however, such as might have come from infinity, there will be an internal gradient, the center of the material will be warmer. After all, we are considering an aneroid calorimeter with a thermal head equal to the temperature rise.

In the method of letting the calorimeter run up with the furnace the internal gradient error is very, very much less, since it then corresponds not to the whole gradient, but only to the change in that gradient over a few degrees of temperature.

The difficulty of knowing the furnace temperature is not avoided by this method, even though the furnace as a whole is kept constant, for the furnace thermocouple may change a tenth as much as the calorimeter, and the change in the furnace wall is likely to be different from that, and unknown.

If electric heating with constant furnace is used for latent heats instead of specific heats, all the difficulties just mentioned are enormously diminished. There is little temperature change, a small thermal head and little thermal leakage, negligible disturbance of furnace temperature, and no internal gradient when the final temperature is measured. Unfortunately, at high temperatures most of the substances whose study will be desirable have a long melting range, due to impurity, so that a considerable part of the latent heat appears below the melting point as an exaggerated specific heat, and must be determined as such. The connecting up of this specific heat determination with a determination of the rest of the latent heat under constant furnace temperature is an interesting problem.

Table II gives various values of the heat capacity of the "hot" calorimeter with its contents. Columns 2 and 3 give values of watts-temperature difference from Table I for the period before and that after the sintering at 1200°. Column 4 is their ratio, that is, it shows, as already said, the increased proportion of heat lost without reaching the calorimeter wall, the increased loss being probably a result of the sintering. Columns 5 and 6 give values of heat capacity obtained from columns 2 and 3 and from the smooth curve of Fig. 2. Columns 7 and 8 are independent values of heat capacity obtained by method (3). Column 9 is their ratio. Column 10 contains approximate values of the specific heat of the silicate powder at different temperatures. Duplicate values of the specific heat, whose averages appear in columns 7 and 8, seldom differed as much as 2 per cent.

The averages in columns 4 and 9 happen to agree rather better than that. This agreement accords with the inference stated already, that the change between earlier and later results came by direct escape of heat, though they do not prove that.

Along with this agreement the table shows two discrepancies.

The change with temperature in silicate specific heat in column 10 is actually greater than that of the whole calorimeter and contents, since the specific heat of platinum varies much less. Yet the temperature coefficients of the heat capacity *as determined* (last 2 lines of the table) are far greater than that in column 10. This coefficient is greater in the later results, which

TABLE II  
Comparison of Heat Capacities

1	2	3	4	5	6	7	8	9	10
Tempera- ture	Watts + temperature difference of calorimeters Early	Late	Ratio	Heat capacity from columns 2 and 3 and Fig. 2 Early	Late	Heat capacity from single method (3) Early	Late	Ratio	True specific heat
300		.0298				.651	.715	1.10	.243
400	.0332	.036	1.09	.694	.754		.773		.253
600	.0478			.779					.269
800	.071	.082	1.16	.892	1.03	.850	.984	1.16	.278
1200					1.26		1.47		.310
Temperature coefficient-	300°:800°					1.30	1.37		
ent or ratio of:	400°:800°			1.28	1.37		1.27		1.096

suggests that its undue amount is partly due to the direct loss of heat, which is also greater in the later experiments, but which was only increased, not caused, by the last sintering at  $1200^{\circ}$ . Hence this evident error is explained, to a considerable extent, at least.

The fact that the temperature coefficient in columns 5 and 6 is different from that in columns 7 and 8 is an unexplained systematic error, and is a reminder of the errors possible in this kind of work.

The greater temperature coefficient of the later as compared to the earlier results shows that the direct heat loss increased relatively to the loss from the calorimeter wall. This could hardly be if the direct loss were due to conduction from the wires of the coil, and points to radiation from the experimental material as the source. For this is the only increase of loss likely to result from having the material shrink, since the shrinking is away from the wall, but toward the wire. Undoubtedly if the calorimeter had had a metallic cover, all these errors would have been greatly reduced. The lack of one is regrettable, but not unjustifiable, for when the work was started I had no idea how far it would be carried.

The precision, that is, the agreement of repeated determinations, in the experiments giving columns 7 and 8, compared with the large systematic errors appearing in Table II, furnishes a striking illustration of the desirability, or necessity, of using repetition or substitution methods in this type of calorimetry. At the same time the large effect coming from a comparatively slight sintering is a reminder of the difficulty there may be in getting a satisfactory repetition or substitution. It has already been pointed out that the application of these methods in latent heat determination is much restricted.

The electric energy was measured by the aid of potential leads of fine platinum wire to the ends of the heating coil. The insertion of these wires proved very easy, while an attempt to avoid them by allowing for the resistance of the current leads into the furnace caused confusion and loss of time.

At  $1200^{\circ}$  leakage of current through the experimental material from the heating coil to the calorimeter wall caused a disturbance of the temperature reading of 3 or 4 degrees. It is not satisfactory to correct for disturbances of this magnitude. Fenner's method of equipotential shielding<sup>1</sup> may avoid the difficulty in many cases. Alternating current will not disturb the temperature readings, and can probably be measured accurately enough, in view of the other errors.

This account of our investigation shows many points which could be made much clearer by further experiment. The very number of these is a strong reason for not proceeding further. For even after a good deal more had been done still more would seem desirable. One reason for the present work was to test the probable value of the furnace calorimeter for certain very delicate determinations of specific heat. The conclusion reached was that the dropping method is more promising. A report of the work already done has seemed likely to prove useful to others immediately interested in furnace calorimetry, but further work seems properly left to them.

<sup>1</sup> J. Am. Chem. Soc., 36, 2016 (1914).

### Summary

A discussion is given of calorimetry performed within furnaces, with a report of various experiments. The most salient points are:

1. With small calorimeters (order of 1 cm in diameter) at 600° and higher the thermal leakage is hundreds of times as great as in ordinary calorimeters, yet the errors with larger calorimeters are greater still.

2. Twin calorimeters, when they can be kept at nearly the same temperature, are valuable, especially for eliminating the effects of changes in furnace rate.

3. The temperature generally should be, and often must be, measured at the calorimetric wall.

4. Electric heating is practically indispensable for determining latent heats; of less value for specific heat. The problem of distributing the electric heat properly is likely to be serious.

5. The precision obtainable depends greatly on the compactness, permanence, and insulating quality of the experimental material. It seems likely to decrease considerably as the temperature gets higher.

6. Furnace calorimetry promises a fascinating test of experimental skill, but when the necessary checks and calibrations are taken into account it is not so far ahead of other methods in speed as is often supposed. As to precision, it seems promising for some latent heat determinations, much less so for specific heat. In no case does the precision seem likely to be better than 1 per cent.

*Geophysical Laboratory,  
Carnegie Institution of Washington,  
December, 1929.*

19-73

## RESEARCHES ON NITROUS OXIDE

BY ARTHUR NEVILLE COPNALL BENNETT

Whilst the results obtained by the use of nitrous oxide gas in anaesthesia have generally been satisfactory, yet on occasion ill effects have been observed, the causes of which have not been understood. Consequently the chemical purity of the gas has been suspected, and it has been felt by anaesthetists that some definite tests should be available for detecting impurities which might be present. In 1911 Dr. Warren Smith, in conjunction with E. D. Leman<sup>1</sup> investigated the problem for the purpose of submitting some non-official tests for insertion in the American Pharmacopoeia. More recently Dr. Hadfield<sup>2</sup> (Secretary of the Anaesthetics Committee of the Medical Research Council) discussed the subject in a paper entitled "Nitrous Oxide: its Impurities and the Establishment of Tests suitable for Official Adoption." He pointed out that there are no official chemical tests for nitrous oxide in the British Pharmacopoeia and suggested that the tests given in the American Pharmacopoeia are inadequate and not sufficiently sensitive. Dr. Hadfield described other tests which might be more suitable, but which he considered required further examination. The work described in this paper has been conducted in order to select standard methods and if possible to find simple routine methods for the analysis of some of the probable impurities in nitrous oxide, and further to examine the behaviour of these impurities in cylinders of the commercial gas.

Nitrous oxide is produced by the decomposition of ammonium nitrate by heat. Detailed methods of its manufacture and methods of testing its purity are given by Baxter<sup>3</sup> and by Crowell<sup>4</sup>. The ammonium nitrate used should be 99.8% pure and free from organic matter. If below this standard it should be dissolved in water, freed from chlorides and sulphates and re-crystallised.

Whilst there are several impurities which might possibly be detected in commercial nitrous oxide, there is only one—nitrogen—which is found in comparatively large quantities. This impurity which is always kept as low as possible has in the past been regarded as harmless. Recently however, it has been considered that a large percentage of nitrogen may be serious in that it might produce asphyxia. Small quantities of oxygen are usually found present, and also moisture, but the content of the latter is always kept low on account of freezing up in the valve. Carbon dioxide is found in nitrous oxide produced by some companies only. Its presence is, however, thought to be advantageous. Although there appears to be no record of

<sup>1</sup> J. Am. Chem. Soc., 33, 1116 (1911).

<sup>2</sup> Proc. Roy. Soc. Med., XIX, 2, 17 (1926).

<sup>3</sup> Anaesthesia and Analgesia, III, 4, 121 (1924).

<sup>4</sup> Anaesthesia and Analgesia, III, 4, 121 (1925).

carbon monoxide having been detected in nitrous oxide, yet its presence, as with the case of cyanogen, has been considered because of the possible presence of carbon or its compounds which are sometimes added to the original ammonium nitrate. On account of the somewhat slow absorption of nitric oxide in aqueous solvents and of its extremely poisonous nature, this impurity has greatly concerned the nitrous oxide manufacturers and anaesthetists. Although, however, the higher oxides of nitrogen have been detected in nitrous oxide, the gas normally appears to be remarkably free from these impurities. Ammonia has been detected in American nitrous oxide, and hydroxylamine has been suspected; but these appear to be fairly easily removed when suitable scrubbing towers are used. The halogens, although usually tested for, do not appear to have been detected. Oil, arsine, and combustible gases have all been considered but are rarely tested for.

It has been found in this research that nitrogen is always present in considerable quantities in commercial nitrous oxide. The oxygen content always small was of the order 0.3-0.5%. About 0.2% of carbon dioxide was detected in some samples, whilst others contained none. The moisture content varied from 0.01-0.05% in the samples analyzed. Other impurities such as NO, NO<sub>2</sub>, CO, and NH<sub>3</sub>, have been looked for, the two gases NO and NO<sub>2</sub> particularly, but have not been detected in any of the cylinders examined.

Before describing the main part of this work, it should be noted that the only cylinder of gas which had given unsatisfactory results was received in the first week of the research. The cylinder was nearly empty, but sufficient gas was present for the tests of the American Pharmacopoeia, the blood test and washing out nitrogen test employed by Dr. King, to be applied.

The AgNO<sub>3</sub>, KI starch, litmus and KMnO<sub>4</sub> reagents were unchanged, and no positive result was obtained from the blood test. The Ba(OH)<sub>2</sub> test showed that a considerable quantity of CO<sub>2</sub> was present and the nitrogen test gave a value of 5% which, however, in view of later work, was probably too high. Passing the gas through the Nessler reagent produced no effect, which showed that ammonia was not easily detectable.

#### The Nitrogen Impurity

Of the direct methods of estimating N<sub>2</sub>O in mixtures of N<sub>2</sub>O and N<sub>2</sub>, probably the most accurate is that of Baskerville and Stevenson.<sup>1</sup> In this method the N<sub>2</sub>O mixture is admitted into a stream of hydrogen, the dried gases are passed over hot copper, and the water formed is collected in suitable absorbers and weighed. For determining the nitrogen in an N<sub>2</sub>O mixture the freezing-out method described by Burrell & Jones<sup>2</sup> is more suitable. In this the gas mixture is measured into an evacuated trap, the trap is immersed in liquid air, and the uncondensable nitrogen is pumped off and measured.

<sup>1</sup> J. Ind. Eng. Chem., 3, 549 (1911).

<sup>2</sup> J. Ind. Eng. Chem., 8, 735 (1916).

A sample of commercial nitrous oxide supplied was found to contain nitrogen only as the large impurity, so this was used for comparing the two methods, Table I.

% N <sub>2</sub> O by Baskerville and Stevenson method.	% Uncondensable gases by freezing out method.	Total %
90.52%	8.0%	98.5%
92.2%	8.0%	100.2%
91.7%	7.9%	99.6%
92.1%	7.45%	99.5%

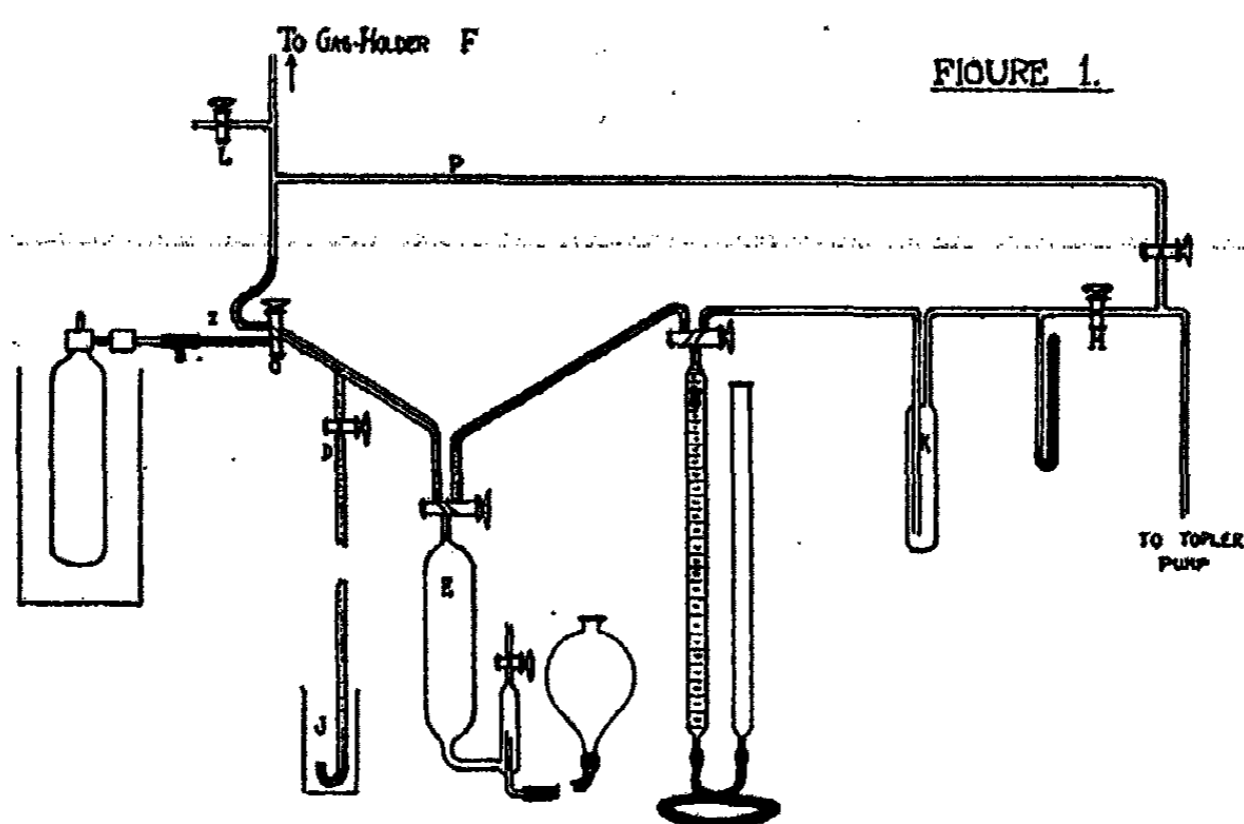

FIG. 1

The results given in Table I showed a fairly good agreement and suggested that for further work the quicker freezing-out method could be used for estimating the uncondensable gases in commercial N<sub>2</sub>O. An advantage in the freezing-out method is that the oxygen impurity, though usually very low, can be determined at the same time by washing the uncondensable gases pumped off with sodium pyrogallate solution and measuring the diminution in volume.

Since the freezing-out method was adopted as a standard method, a detailed description of the apparatus and experimental procedure is given below:—

*The Apparatus.*

Fig. 1 shows the final design of the apparatus used in this work. A brass adapter AB with a leather washer was screwed firmly on the cylinder, and a capillary glass tube was fitted tightly inside the brass tube B. The join was covered by a tightly-fitting thick-walled rubber tubing, which was wired on. The capillary tube was connected via the three-way tap C to a blow-off

tube D and a gas holder E. The blow-off tube was made 80 cms. in length, so that the tubing could be evacuated through C by the Töpler pump without filling the whole space with mercury. The tubing from C to E was gradually sloped downward, so that gas could be displaced by mercury from the gas holder to the blow-off tube. The gas holder E was connected to a gas burette H by means of capillary tubing, and H again was joined to a freezing vessel K. K was connected via a tap M to the Töpler pump. Between K and M was fixed a manometer. A tube P was also inserted, so that the apparatus between the cylinder and the gas holder E could be evacuated through C by the Töpler pump.

The apparatus from the tap H to the Töpler pump was evacuated whilst that from E to H was filled with mercury. The space between C and E, and also the cylinder lead AC were evacuated. Mercury was then admitted to fill the sloped tube up to the blow off tube D.

*Experimental Procedure.*

Gas was blown from the cylinder through C and D into the atmosphere for a few seconds. A sample was then collected in E. When a sufficient quantity of gas was collected in E, the cylinder was closed. About 40-50 cc. of gas from E were measured off in H and admitted into the evacuated vessel K, with tap M closed. K was then immersed in liquid air contained in a Dewar vessel, and was left to stand at least 15-20 minutes. The uncondensed gas was collected through the Töpler pump into a small audiometer in which it was measured. Sodium pyrogallate was admitted to the gas collected and the diminution in volume of the gas was noted. The diminution in volume gave the volume of  $O_2$  in the sample. This method of analysing the oxygen in the uncondensable gas was checked by the Bone-Wheeler apparatus.<sup>1</sup>

*Notes on sampling the Gas from the Cylinder.*

In testing the samples removed from the cylinder, the following points have been examined:—

1. The position of the cylinder. This determines whether the gas drawn off comes from the gas or liquid phase. The percentage of nitrogen in the gas phase is much higher than that in the liquid phase: the distribution ratio for a Coxeter cylinder at 19°C being 5.5.
2. Temperature of the cylinder. This considerably affects the distribution ratio. The distribution ratio increases as the temperature is lowered.
3. The amount removed at a time. The removal of 1 litre of gas does not appreciably affect the concentration of nitrogen in the two phases.
4. The rate of removal of gas. The removal of 1 litre in 10 minutes does not appear to lower the concentration of nitrogen in the gas phase, and the temperature of the cylinder is not sensibly affected.
5. The continued removal from one phase. If the gas is continually removed from the gas phase, the purity of the  $N_2O$  in the cylinder increases.

<sup>1</sup> J. Soc. Chem. Ind., 27, 10 (1908).



The distribution of uncondensable gases in the liquid and gaseous phases of  $N_2O$  in the cylinder, as the weight of the  $N_2O$  in the cylinder decreases.

The full cylinder was weighed. With the cylinder erect, the narrow bore glass tube connected to the adapter AB was joined at the position Z. The cylinder was sampled and the sample was analysed by the freezing-out method. The glass tubing was then cut at Z, the cylinder inverted, and the glass tubing again joined. The gas drawn off from the inverted cylinder (that is the gas drawn from the liquid phase) was sampled, and analysed. The glass tube was cut at Z again and the cylinder re-weighed. About 20-

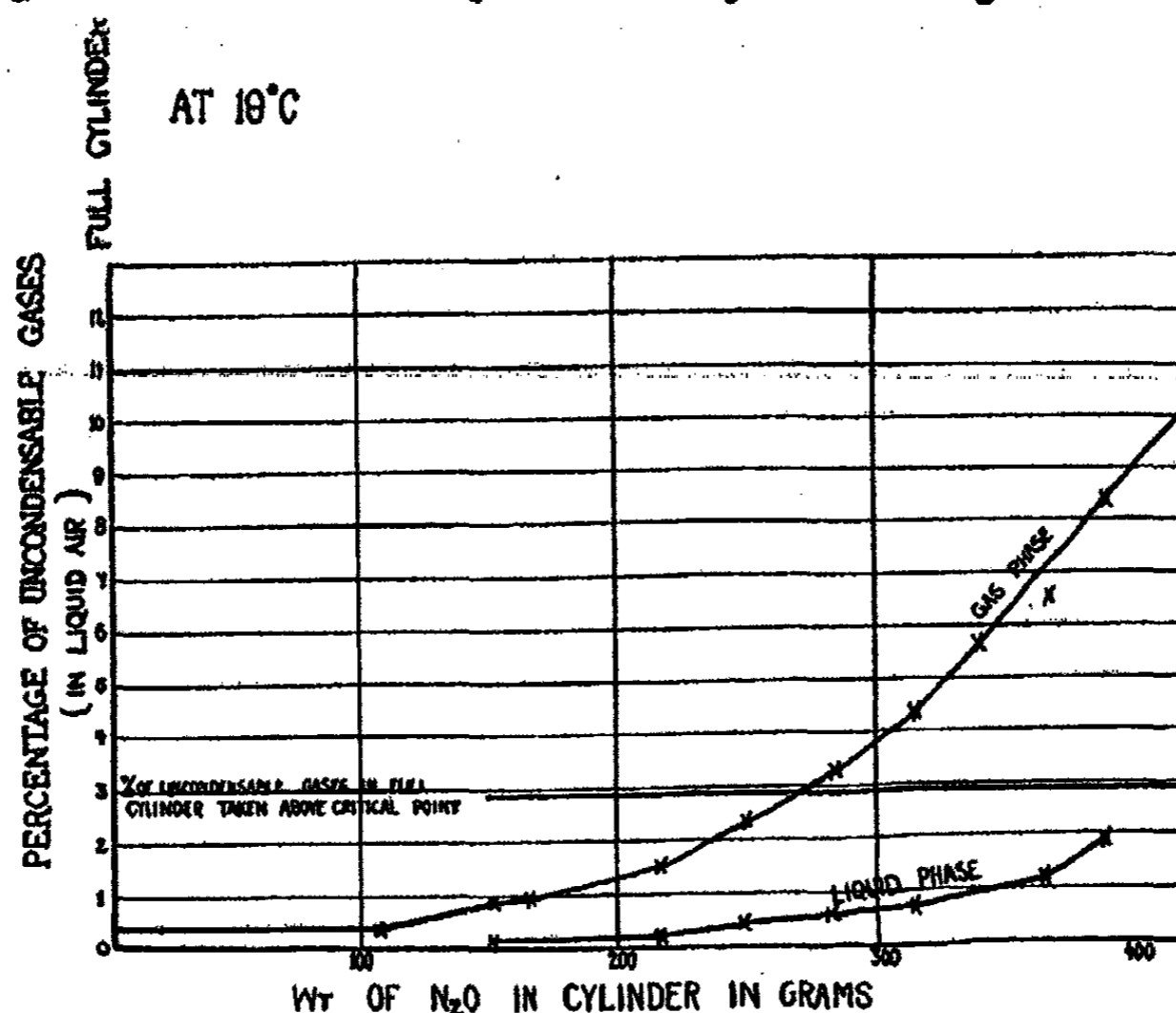

Fig. 2  
% Uncondensable Gases—Total Wt. of  $N_2O$  in Cylinder

50 grams of the gas were blown off, the cylinder was again weighed, and in the erect position was joined on to the apparatus, in the manner described above.

The above procedure of sampling and testing the gas from the gas and liquid phases for different weights of  $N_2O$  in the cylinder was continued until one phase only—the gas phase—remained. This was apparent when the tests for the gas drawn either from the erect or inverted cylinder were the same and did not vary with the weight of  $N_2O$  left in the cylinder.

After the first few readings were obtained it was found necessary to keep the cylinder in a thermostat at 19°C. (This temperature was chosen, since it was about the room temperature, when the other samples were taken.)

Whilst the cylinder was still full of  $N_2O$ , it was heated above the critical point of  $N_2O$  (36.5°C) to a temperature above 40°C. After keeping the cylinder at this temperature for 2 hours the gas was sampled and analysed. In this way the percentage impurity in the whole cylinder was determined. The result obtained is shown as a straight line across the graph (Fig. 2).

The percentages of uncondensed gas for the upright and inverted cylinder were plotted against the weight of  $N_2O$  in the cylinder.

The graph, Fig. 2, is typical for a normal cylinder of gas. It is obvious that the percentage of nitrogen impurity in a nearly empty cylinder sent for examination cannot be taken for the percentage of nitrogen in the original gas. From the curve, however, a rough estimate might be made by assuming that a similar graph is obtainable for all cylinders filled with  $N_2O$ . On this assumption the percentage of nitrogen in the initial gases would be estimated by proportion.

Similar curves to Fig. 2 were obtained for the distribution of uncondensable gases in cylinders of nitrous oxide produced by other companies.

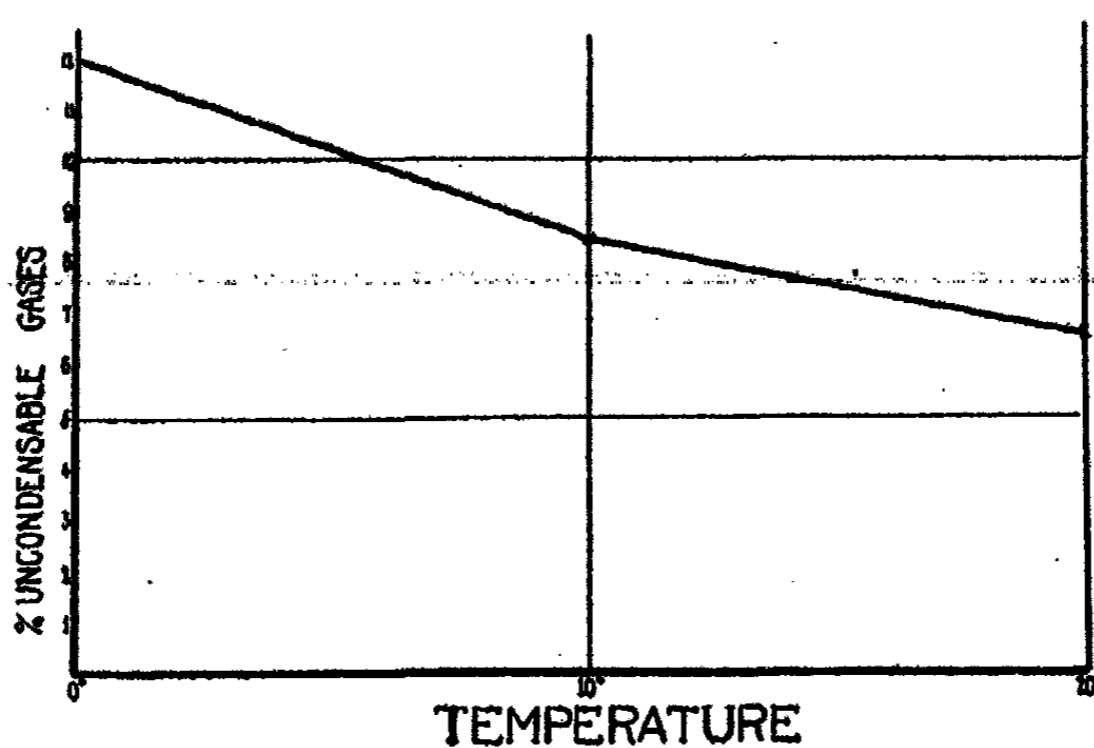

FIG. 3  
% Uncondensable Gases in Gas Phase-Temperature

*The effect of temperature of the cylinder of  $N_2O$  upon the percentage of uncondensable gases in the gas phase.*

The cylinder was placed in a thermostat for two hours at  $20^{\circ}C$ . It was then sampled from the gas phase and analysed by the freezing out method. This procedure was repeated for the temperatures  $10^{\circ}C$ ., and  $0^{\circ}C$  with the (approx.) same weight of  $N_2O$  in the cylinder.

The results obtained (Fig. 3) show how necessary it is in testing the purity of the gas, when two phases are present, that the cylinder should be kept at a known constant temperature.

It may here be noted that, when gas is rapidly removed from a cylinder, the cylinder is found to cool so much that frost appears on the outside. If such cooling is produced in removing gas, it is conceivable that the initial gases removed at this temperature from the top of the cylinder might contain 20% or more of nitrogen. On one occasion a nearly empty cylinder was opened and the gas was allowed to escape fairly rapidly. Since much frost was formed on the outside, a thermometer was placed on the outside wall of the cylinder. The temperature reading so obtained was about  $-5^{\circ}C$ . for several minutes after the valve had been closed again.

Similar curves to Fig. 3 were obtained in the same way for nitrous oxide cylinders supplied by other companies.

Comparison of the results obtained from cylinders supplied by three companies are given in Table II.

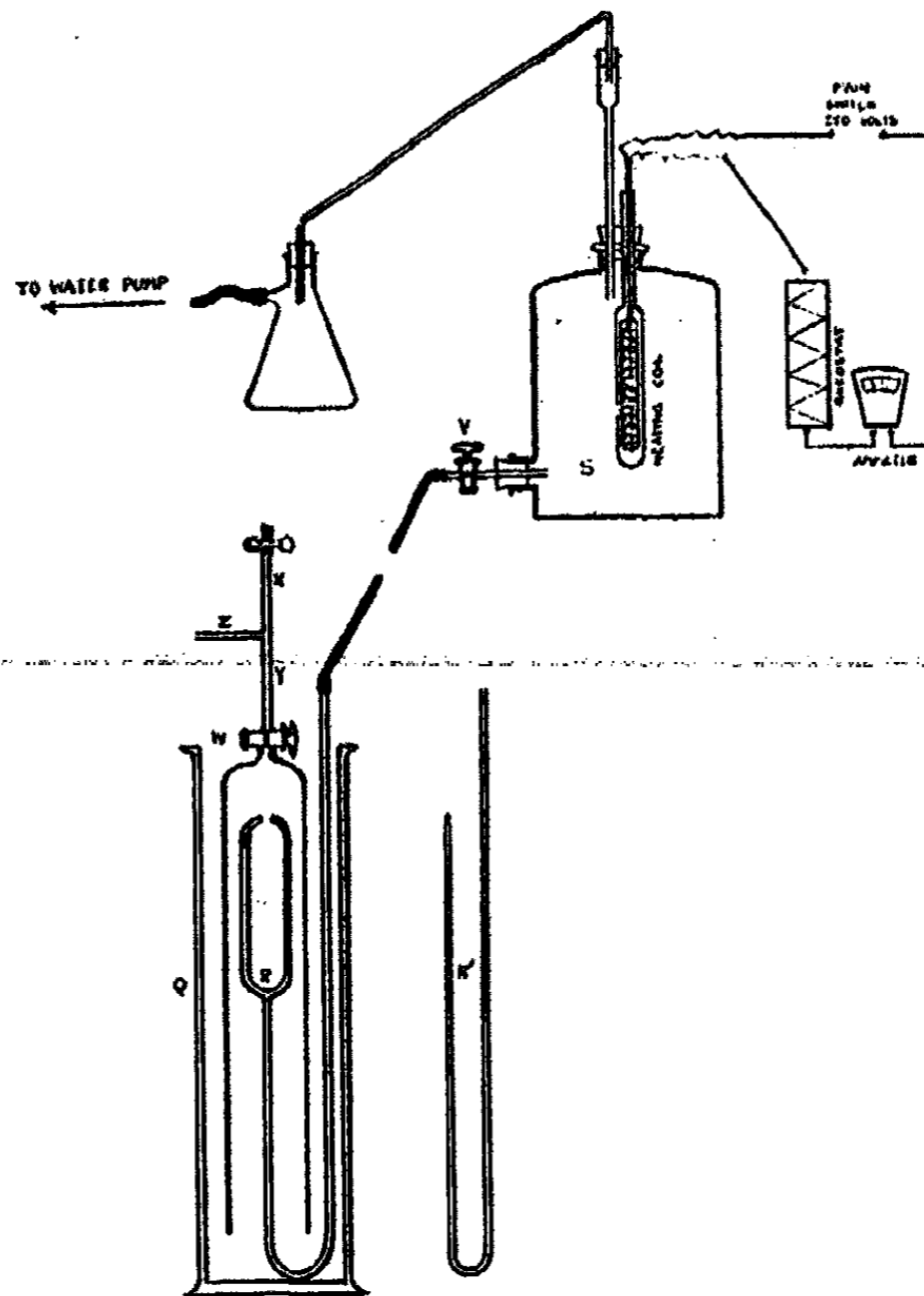

FIG. 4

TABLE II

Company	% N <sub>2</sub> in gas phase at 20°C.	% N <sub>2</sub> in liquid phase at 20°C.	% N <sub>2</sub> above critical point 36.5°C.	% N <sub>2</sub> in gas phase at 0°C.	% N <sub>2</sub> in gas phase at 10°C.
A.	10.3%	2.0%	2.9%		
B.	6.9%	1.6%	2.0%	12.0%	8.8%
C.	10.6%	2.1%	3.0%	15.6%	11.3%

#### A Routine Method of estimating N<sub>2</sub> in N<sub>2</sub>O

Since the freezing-out method requires special apparatus and liquid air, which are not available in all laboratories, and further, since the apparatus needs careful manipulation, a simpler method of estimating the nitrogen impurity in N<sub>2</sub>O was required. The investigation began with an examination of the previously existing washing-out methods, in which the liquids used were (1) ordinary water, and (2) freshly boiled distilled water exposed to the

atmosphere. The results obtained were compared with those given by analyses of the same samples by the freezing-out method, and were found to be 2-3% higher. In both cases this error was found to be due to the expulsion from the water of the gases already in solution. The following method, in which the water is freed from absorbed gases, has, however, given reliable results, and has been suggested as suitable for routine work.

*The Apparatus and Procedure.*

A 200 cc eudiometer tube (Fig. 4) graduated in cc was connected via tap W to a T-piece XYZ. The arm Z of the T-piece was connected by rubber

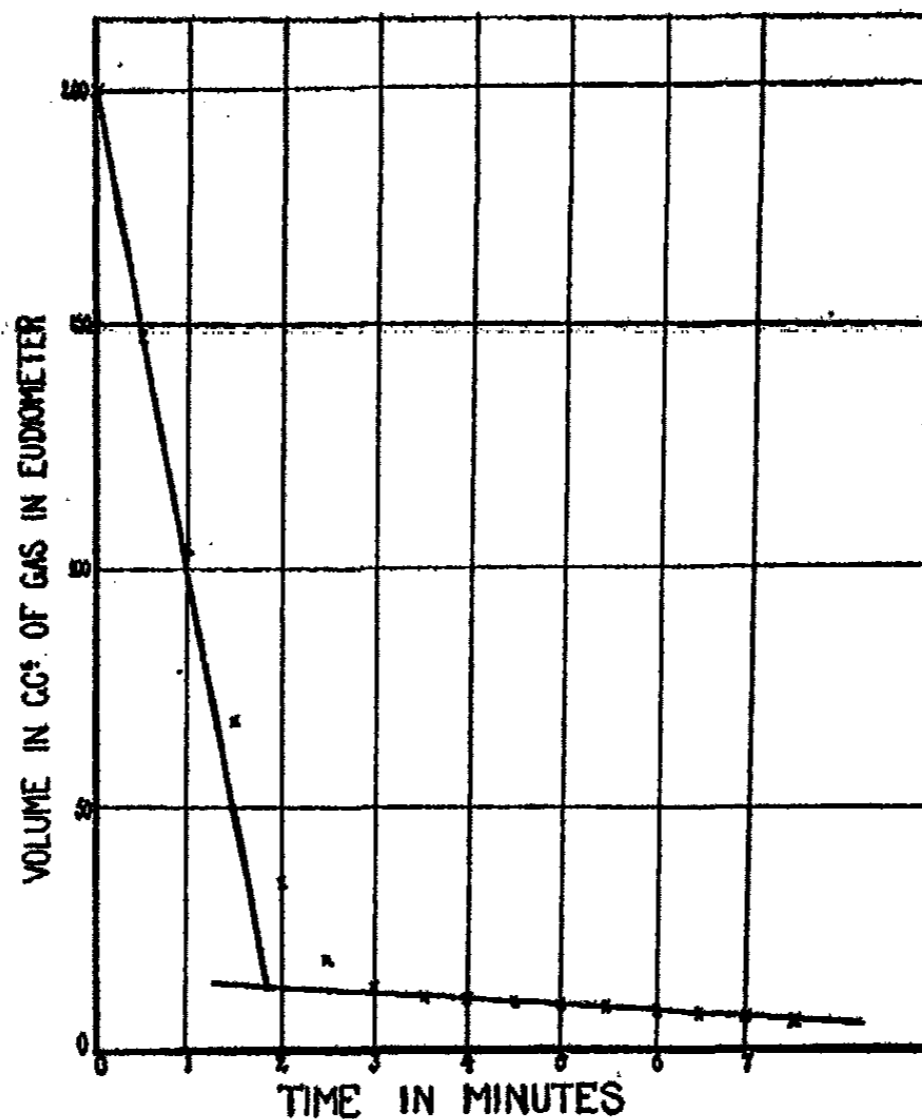

FIG. 5

tubing to a cylinder of nitrous oxide to be tested. The eudiometer and tube XY were filled with distilled water, so that a water trap was formed at the T piece. A piece of rubber tubing with clip was fixed on the end of the arm X.

Before filling the eudiometer, the cylinder was opened and the clip at X was also opened. Thus air in the tubing from the cylinder to X was washed out by a slow stream of  $N_2O$  which bubbled through the water trap. The clip on X was then closed, the tap W quickly opened, and a sample of gas (about 200 cc) was collected in the eudiometer.

The eudiometer was disconnected and by means of a glass cup was transferred to a 2-litre measuring cylinder Q filled with water. A jet R, which was connected by rubber tubing to a large aspirator bottle S containing air-free water was inserted into the eudiometer.

Before analysis the volume and temperature of the gas in the eudiometer were read. The top of the aspirator S was opened to the atmosphere and the tap V was opened. The time of opening was recorded and the eudiometer was held so that a maximum of spray was obtained. At the end of every minute (or half minute) the spray was stopped for about 5 sec. and the volume of gas left in the eudiometer was read. When the gas had nearly all dissolved and the loss of gas with time appeared constant, the spraying was stopped. In this way a number of time-volume readings were obtained. The curve produced by plotting these readings was of the type shown in Fig. 5.

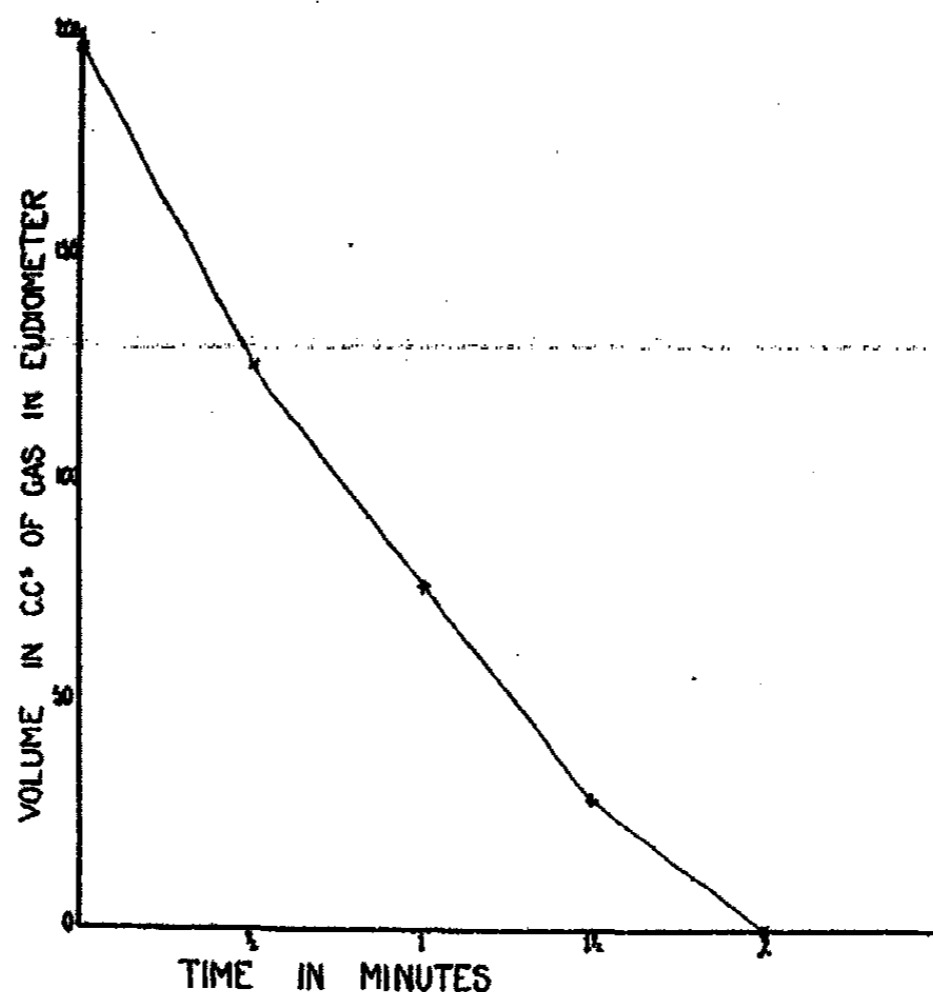

FIG. 6

The straight parts at the beginning and end of the curve were produced to intersect. The coordinate on the volume axis of this point of intersection gave, as shown experimentally, the volume of the  $N_2 + O_2$  impurity.

The air-free water used for spraying the gas was distilled water boiled out in vacuo. It was prepared in a large 10 litre aspirator bottle S, connected through the stopper at the top to a water pump. The water was heated by a coil of nichrome wire wound on asbestos paper sealed inside a glass tube, and was boiled in vacuo at a temperature of about  $30^{\circ}$ - $35^{\circ}$  C. until bumping was very violent (about 2 hours).

The type of jet used does not affect the final result, but a long time (about 20 mins.) is taken to wash the gas, when the simpler jet R' is used for spraying. The type of spray R used in this work was obtained by dividing the stream of water from S, so that it issued from two fine jets impinging on one another at an angle of  $90^{\circ}$ C. With this spray the washing could be completed in seven minutes.

*Procedure for comparing Washing-out Method with the Standard Freezing-out Method.*

The gas was collected in the gasholder E in the freezing-out apparatus (Fig. 1). A sample of gas in E was analysed by the freezing-out method. The eudiometer tube described above was filled with mercury and placed in the dish J over the blow-off tube. It was then filled with the gas sample from E by displacement. The eudiometer filled with gas was transferred by means of a cup to the two litre measuring cylinder Q, where the mercury was displaced by water, the jet R was inserted in the eudiometer and the gas was sprayed as described above.

The curve of results shown on the graph, Fig. 5, is representative of a large number of experiments in which the freezing-out method was compared with the washing-out method. A sample of gas purified by the freezing-out method was tested by the washing-out method, and the curve, Fig. 6, was produced. The curve is practically straight, and, except for a small bubble left at the end, solution of the gas was complete in two minutes.

Some experiments were performed to observe if on adding nitrogen and oxygen to the gas, the increase in percentage of insoluble gas was recorded by this method. Graphs similar to Fig. 5 were obtained. The following calculations show that the volumes of gas added are accounted for within the limits of experimental error.

It may be concluded (from the above experimental work), therefore, that the washing-out method described above using air-free water prepared by boiling the water in vacuo will analyse to within 0.5% mixtures of from 0-15% of N<sub>2</sub> or O<sub>2</sub> in N<sub>2</sub>O.

TABLE III

<i>Expt. 1.</i>		
Test of gas by freezing out method	=	7.0%
Volume of nitrogen added to sample	=	9.4 cc.
"    " N <sub>2</sub> O sample taken	=	191 cc.
Calculated total volume of nitrogen present.....	=	22.9 cc.
By graph                    do.	=	23.5 cc.
<i>Expt. 2.</i>		
Test by freezing out method	=	6.5%
Volume of nitrogen added	=	18.8 cc.
"    " N <sub>2</sub> O sample taken	=	183 cc.
Calculated total volume of nitrogen present (11.9 + 18.8).....	=	30.7 cc.
By graph                    do.	=	30.4
<i>Expt. 3.</i>		
Volume of oxygen added	=	9.7 cc.
"    " N <sub>2</sub> O sample taken	=	195. cc.
Calculated total volume of nitrogen and oxygen present =		
(12.7 + 9.7).....	=	22.4 cc.
By graph                    do.	=	22.1 cc.

*The preparation of air-free water.*

The question of testing the water for absorbed gases before an analysis has been considered, and of the methods suggested that of observing hard bumping was found to be quite reliable in this work. The method of analysing a sample of  $N_2O$  of known nitrogen content is, however, probably the best.

**Detection of Traces of Nitric Oxide in Nitrous Oxide Gas**

Several methods have been suggested and used for detecting NO, but so far the blood test and the permanganate test appear to be the only simple tests which have been adopted for detecting small quantities of NO in  $N_2O$  gas. A somewhat lengthy colourimetric test has, however, been described in a paper by Allison, Parker and Jones<sup>1</sup> in which they claim to be able to detect qualitatively five parts of NO in a million parts of  $N_2O$ .

*The Permanganate Test.*

A series of experiments were performed to determine whether the  $KMnO_4$  test could be used for determining small quantities of NO in  $N_2O$ . It was found that considerable decomposition of the  $N/2000$   $KMnO_4$  used was brought about by passing a fine stream of  $N_2O$  or oxygen through it. Consequently, no reliable results were obtainable for gases containing less than 0.01% NO.

*The Blood Test for detecting NO in  $N_2O$ .*

The blood test has been regarded as a very sensitive and simple test for small quantities of nitric oxide. The test depends on the formation of nitroxyhaemoglobin which has similar properties to carboxyhaemoglobin. Nitroxyhaemoglobin is said to be more stable than carboxyhaemoglobin. Both substances give two strong absorption bands in the visible spectrum. The position of the bands, however, appear to be the same for each compound, so that this test is not suitable for detecting NO, if CO is present.

The object of the following experiments was to determine how sensitive this test is for NO.

*Apparatus.*

The cylinder of  $N_2O$  A (Fig. 7) to be tested was connected by means of an adapter and tubing to a sintered glass absorber B, which was constructed

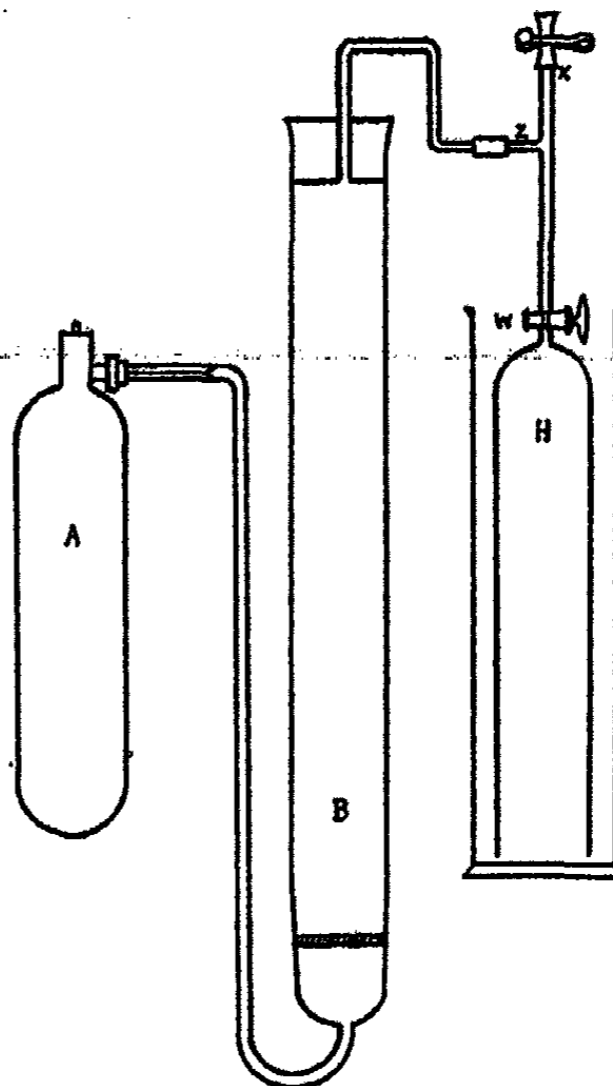

FIG. 7

<sup>1</sup> U. S. Bureau of Mines Tech. Paper No. 249.

with a column 18 inches high and 1 inch diam. above the sintered glass plate (to prevent the foam formed from escaping). The top of the absorber was fitted with a rubber stopper through which a tube led to the eudiometer H.

*Procedure.*

The blood was prepared by diluting one volume of defibrinated dog's blood with thirty volumes of water, 10 cc. of this solution were placed in B, and gas from the cylinder A was bubbled through the solution. The speed of the gas and consequently the volume used, was estimated by collecting a quantity of the gas in the eudiometer in a known time.

After passing a quantity of gas through the solution, the latter was transferred to a narrow glass parallel walled cell. The solution was examined through a Hilger spectrometer with a pointer light lamp as a source of light. The visible bands were measured. The solution was then reduced by Stokes' reagent (ferrous ammonium tartrate) and the band or bands were again measured. If the two bands persisted after reduction they were assumed to show the presence of nitroxyhaemoglobin.

The results obtained are summarised briefly in Table IV:—

TABLE IV

Expt.	Vol. of gas bubbled through in litres	Vol of NO present in c.c.	Conc. of gas in parts per million	Time taken to pass gas through in hours	Test
1.	7.6	0.1	10	7.5	No HbNO
2.	14	0.24	13	7.2	"
3.	3.56	0.3	80	8	"
4.	32.6	2.7	80	20	Faint trace HbNO
5.	5.5	3.5	630	6	Distinct trace HbNO

The above tests were confirmed by an independent observer.

The concentration of NO in these tests may have been higher than they were found to be on account of decomposition of NO in the cylinder. It is significant, however, that the same cylinder of gas used in experiment 1 (Table IV) was tested by another method (not described, but by which only 3% of the NO was recoverable) and a very distinct indication of nitric oxide was obtained (6 litres were used).

To examine the blood test further it was felt that a Hartridge reversion spectroscope should be used. It is doubtful, however, whether much more dilute solutions than 0.01% of NO in N<sub>2</sub>O could be detected even by the reversion spectroscope. The chief advantage in the latter being that quantitative estimations of the carboxyhaemoglobin and nitroxyhaemoglobin are possible. As one of these instruments could not be borrowed, the examination of the blood test was not continued.



A New Method of Estimating NO in N<sub>2</sub>O

It was thought that a delicate test for NO might be obtained by converting the NO by excess of oxygen into NO<sub>2</sub> or N<sub>2</sub>O<sub>3</sub>, absorbing the resulting gases in water or NaOH, and then applying sensitive colourimetric tests to the solution for nitrites or nitrates. In the first apparatus constructed the N<sub>2</sub>O containing NO was mixed with an oxygen stream and was passed through absorbers containing water. Later, NaOH solution was substituted for water. In this way only qualitative results were obtained, when gases con-

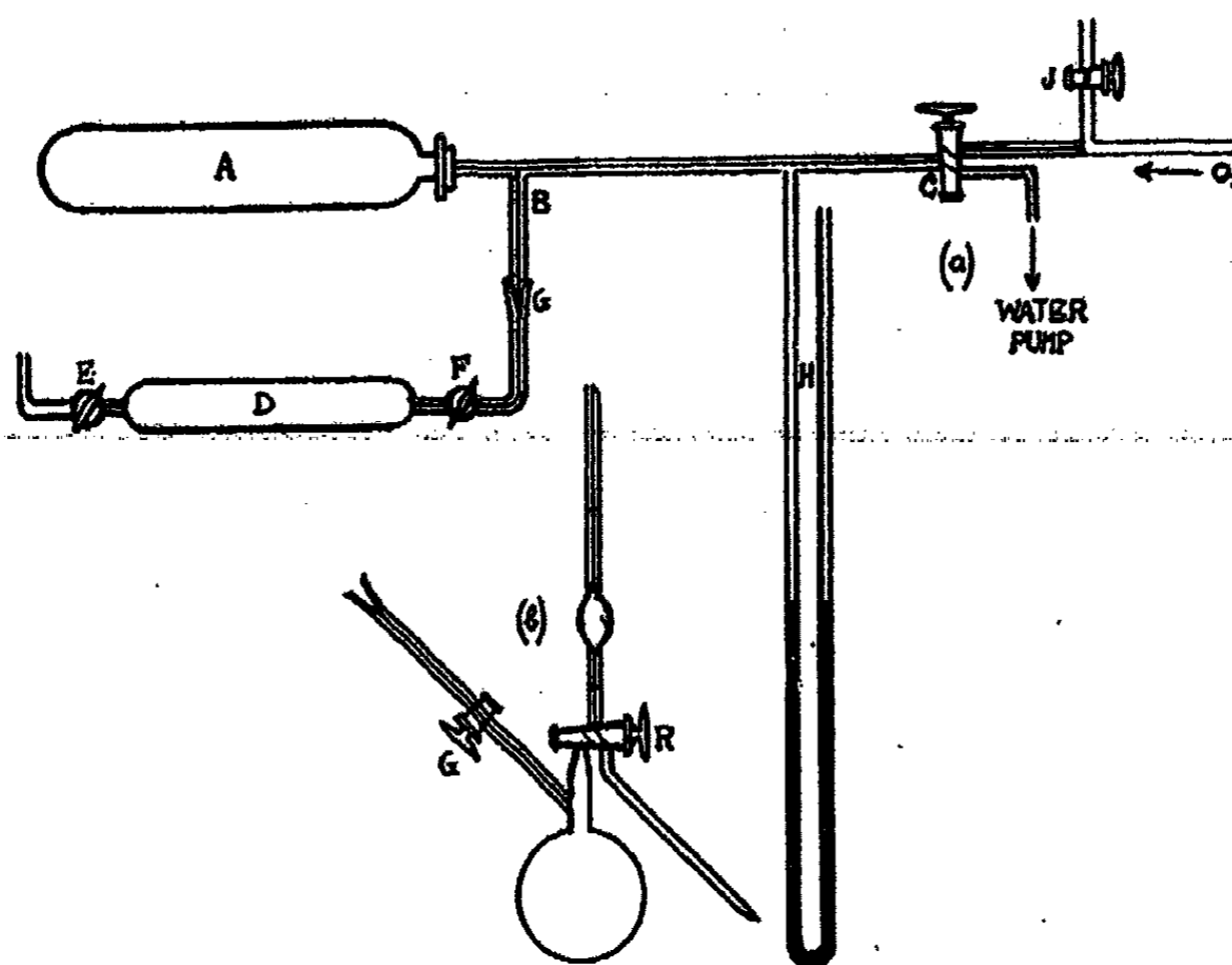

FIG. 8

taining 0.1% NO or less were used. If no oxygen was admitted to the gases the NO present, passed on unabsorbed, although the N<sub>2</sub>O gas contained 0.2% oxygen. The time allowed for mixing the NO with oxygen considerably affected the results. An increase in surface of glass in contact with the gases did not affect the results.

The apparatus described below was adopted later, and has been found to give reliable quantitative results for N<sub>2</sub>O gas containing 0.001% NO. (10 parts per million).

*Apparatus.*

The N<sub>2</sub>O cylinder A (Fig. 8) fitted with adapter was connected by capillary glass tubing through a T-piece B to a two-way tap C on the one side, and to a detachable bulb D fitted with taps E and F at either end. The bulb D could be removed at the ground-glass joint G (a rubber pressure tubing joint was afterwards satisfactory.) Between the cylinder and the tap C was sealed a manometer H (80 cms. long). The two tubes from C led to an oxygen cylinder having a blow off safety tube J to the atmosphere, and to a water pump respectively.

*Procedure.*

The procedure was as follows:—

1. Evacuate the bulb D by means of the water pump. Close C.
2. Through tap E admit 10 cc. of nitrite free 4N NaOH.
3. Admit  $N_2O$  (to be tested) from A to fill bulb D up to 1 atmosphere pressure. Close cylinder.
4. Admit oxygen until the pressure is half an atmosphere above atmospheric pressure.
5. Close tap F, remove bulb D, shake, leave to stand some time, then run off the solution through E into a test tube.
6. Test solution so obtained for nitrites.

Since the  $N_2O$  in the cylinder used gave no result when tested by this method for NO, it was necessary, in order to calibrate the method, to connect on the apparatus (between A and B) a Lunge nitrometer, a 1 cc. pipette, and a mixing bulb (not shown), for preparing known mixtures of NO in  $N_2O$ .

*Procedure of making a known mixture of NO in  $N_2O$  and testing it.*

Known volumes of NO and  $N_2O$  were admitted to the mixing bulb, and allowed to stand  $1\frac{1}{2}$  hours. The mixture was then transferred to D, which had previously been evacuated and  $N_2O$  was added to increase the pressure in D to 1 atmosphere. The gases were again left to mix for  $1\frac{1}{2}$  hours. 10 cc. of 4N NaOH (nitrite free) were then blown into the bulb and oxygen was forced in until the pressure was  $1\frac{1}{2}$  atmospheres.

*Analysis of solution for nitrite.*

The solution in which the gases had been absorbed was tested by the Greiss Ilosvay reagent for nitrites, which was prepared as follows:—

- (a) 0.1 gm. of  $\alpha$ -naphthylamine was boiled in 20 cc. of water and poured through a filter into 150 cc. of 6 N. acetic acid.
- (b) 0.5 gm. of sulphanilic acid was dissolved in 150 cc. of 6 N acetic acid.

*Procedure.*

4.5 cc. of each of the solutions a and b were mixed in a test tube and heated until the first indication of boiling was obtained. The contents of the tube were poured into another test tube containing 1 cc. of the solution to be tested. The mixture was poured from one tube to the other twice and was then left to cool.

If, to take an example, the colouration produced suggested that the nitrite content was 1 part per mil. four or five test tubes were taken and to each was added 1 cc. of 4N NaOH (nitrite free) and 0.8, 0.9, 1.0, 1.1 and 1.2 cc. respectively of an aqueous solution of  $NaNO_2$  containing 1 part per million of  $HNO_2$ . Into each of these test tubes an equal volume mixture of the solutions a and b previously heated as above was added, so that the total volume of solution in each tube was 10 cc. Each mixture obtained was poured into the boiling tube and back again twice and was then left to cool.

After 20 mins. the solution to be tested was compared against the other five and its  $HNO_2$  concentration thus determined.

The coloured standards prepared were unreliable, if kept more than an hour or so, particularly if in contact with air.

The results given below were obtained by allowing the mixed gases in contact with the NaOH solution in D to stand overnight, and testing the solution in the morning:

Expt.	Vol. of NO admitted	Conc. of NO in N <sub>2</sub> O (in the 1 litre bulb)	Conc. of HNO <sub>3</sub> in pts. per mil	Vol. of NO estimated
1.	.044 cc.	40 pts. per million.	9	.045 cc.
2.	.047 cc.	43 do.	9-10	.045 cc.
3.	.054 cc.	49 do.	10	.050 cc.

These results, when calculated according to the reaction represented by the equations

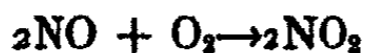

gave figures for the last column (i.e. for the vol. of NO estimated to be present in the original mixture) which were twice as great as those in Column 1. Since nitrites could not be detected from the N<sub>2</sub>O and oxygen alone, it seemed necessary to assume that the above equations did not represent the reactions taking place, and that the NO was converted completely into nitrite. The following equations may possibly represent the reactions

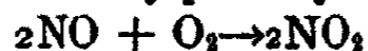

In other words, it is suggested that the NO<sub>2</sub> as formed went into solution as N<sub>2</sub>O<sub>3</sub> by combination with the unoxidised NO. The results given in the last column of the table were calculated according to these equations.

Another design of reaction chamber was made (Fig. 8b), so that smaller volumes of gas could be used, the NaOH could be measured in more accurately, and the apparatus was less clumsy. Tap G was used for evacuating and filling with gases and for removing the final solution for testing. The three-way tap R which was used for introducing the NaOH led to an Ostwald pipette which was calibrated to deliver 10 cc.

	Vol. of NO admitted to mixing	Distributed between	Vol. of NO admitted to chamber	Vol. detected in chamber	Conc. of NO in N <sub>2</sub> O (in pts. per mil.)
1.	0.057	Large chamber 1100 cc.	0.039 cc.	0.034 cc.	35.5
		Small chamber 514 cc.	0.018 cc.	0.014 cc.	
2.	0.048	N = 400 cc.	0.010 cc.		
		Large chamber = 1100 cc.	0.026 cc.	0.025 cc.	23.6
		Small chamber = 514 cc.	0.012 cc.	0.010 cc.	

The litre reaction vessel D and the new vessel L (capacity 51400.) were calibrated against each other by distributing the gas mixture from the mixing bulb between them.

The results obtained for more dilute gas also agreed closely, provided that the gas mixture in the reaction vessel was left for a considerable time after the oxygen was admitted. The graph (Fig. 9) in which the percentage of the NO detected is plotted against the time the gases are in contact after the oxygen admission shows that at this concentration (10 parts per million) the reaction goes slowly. The error involved in estimating the NO is a personal one, because it is colourimetric and may range from 5-10%. In no case, at this concentration, was 100% of the NO detected.

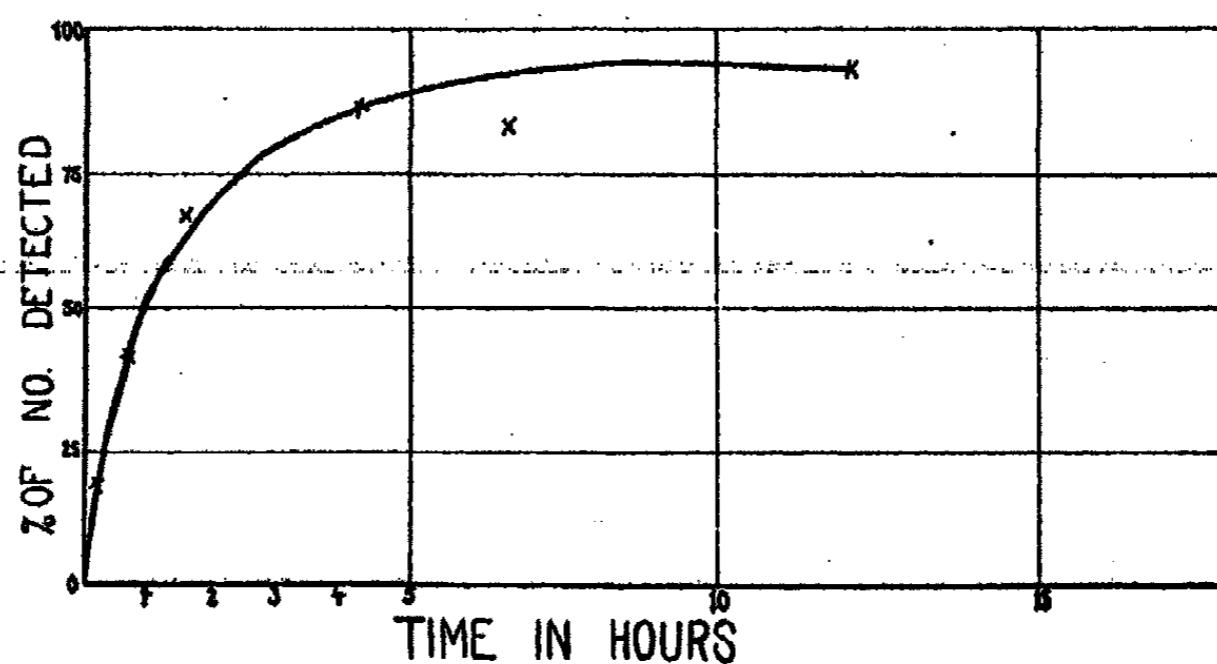

FIG. 9

#### The Oxidation of NO in Presence of NaOH

The work of Bodenstein<sup>1</sup> and others has established that at ordinary temperature NO is oxidised direct to NO<sub>2</sub> without the formation of intermediate compounds such as N<sub>2</sub>O<sub>3</sub> which have been suggested. Since, however, the reaction is slow especially at low pressures and low concentrations, a mixture of NO and NO<sub>2</sub> which will combine to form N<sub>2</sub>O<sub>3</sub> is present at various stages of the reaction. It would seem possible therefore, that if N<sub>2</sub>O<sub>3</sub> formed in this way could be removed rapidly by solution of NaOH or some other suitable reagent, only 50% oxidation of NO would be obtained.

Gay-Lussac in one of his experiments on the reaction of nitric oxide with oxygen converted all his NO into nitrite. Later investigators pronounced caustic soda unsuitable for the quantitative absorption of mixtures of NO and NO<sub>2</sub>. According to Foerster<sup>2</sup> it is essential to nitrite formation that the mixture be absorbed rapidly. Dilution with air is also an advantage. Baudisch and Klinger<sup>3</sup> found that nitric oxide is completely converted into nitrite by solid KOH in presence of air, if the NO is first admitted to the KOH.

<sup>1</sup> Z. Elektrochemie, 24, 183 (1918).

<sup>2</sup> Z. angew. Chem., 21, 2209 (1908); 23, 2017 (1910).

<sup>3</sup> Ber., 45, 3231 (1912).

The results of Briner and Malet<sup>1</sup> show that, if  $N_2O_2$  as soon as formed be absorbed in 3-4N NaOH solution the oxidation of NO may be prevented from proceeding beyond 50%. In this way only nitrites are formed. Briner absorbed the nitric oxide from a stream and in this way did not obtain complete absorption.

The conditions obtained in the present work would appear more favourable for complete absorption than those of Briner. Other conditions such as rapid absorption, admission of NO before oxygen to the NaOH, and dilution of the gas, which would appear from the above remarks to favour nitrite formation are also obtained in the present method. It would therefore seem that the assumption which is necessary to interpret the present results is in agreement with the conclusions of other investigators.

*Stability of NO in cylinders of  $N_2O$ .*

A cylinder in which NO had been admitted and mixed with  $N_2O$  for some experiments made in February was tested by the above method of estimating NO in June, and the following result was obtained:—

1 litre of  $N_2O$  contained 0.015 cc. NO, whereas the original composition 4 months earlier was 0.63 cc. per litre.

It is possible, however, that, since the oxygen content of the  $N_2O$  0.3% was more than sufficient to convert the NO admitted into  $NO_2$ , there was no NO left in the cylinder and the nitrite was formed from  $NO_2$  according to the equation:—



in which case the result given above should be doubled.

Another mixture of NO in  $N_2O$  was made up in a cylinder. 3.6 cc. of NO were mixed with 60 grams  $N_2O$  (30.3 litres). The gas was analysed at certain times with the following results:—

Test	Time after mixing	Conc. of NO in $N_2O$ (in pts. per mil.)
	0	120
1.	40 mins.	24
2.	2 days	2.4
3.	5 days	0

As one cylinder contained NO for 4 months after mixing and another lost all the NO in 5 days, it was suggested that the oxygen content of the  $N_2O$  was lower in one case than in the other. It was also thought that the moisture content in the gas might affect the stability of the NO or  $NO_2$ . This latter point has not been examined.

*Preparing mixtures of NO in  $N_2O$  free from oxygen.*

60 grams of  $N_2O$  were forced into an empty cylinder. The cylinder was surrounded by a large Dewar vessel filled with liquid air and with the valve

<sup>1</sup> J. Chim. phys., 20, 173 (1923).

open the uncondensable gases were pumped off by means of a Töppler pump. NO was admitted into the cylinder, and the valve of the cylinder was then closed.

The mixture of NO so made up was tested for NO periodically with the following results.

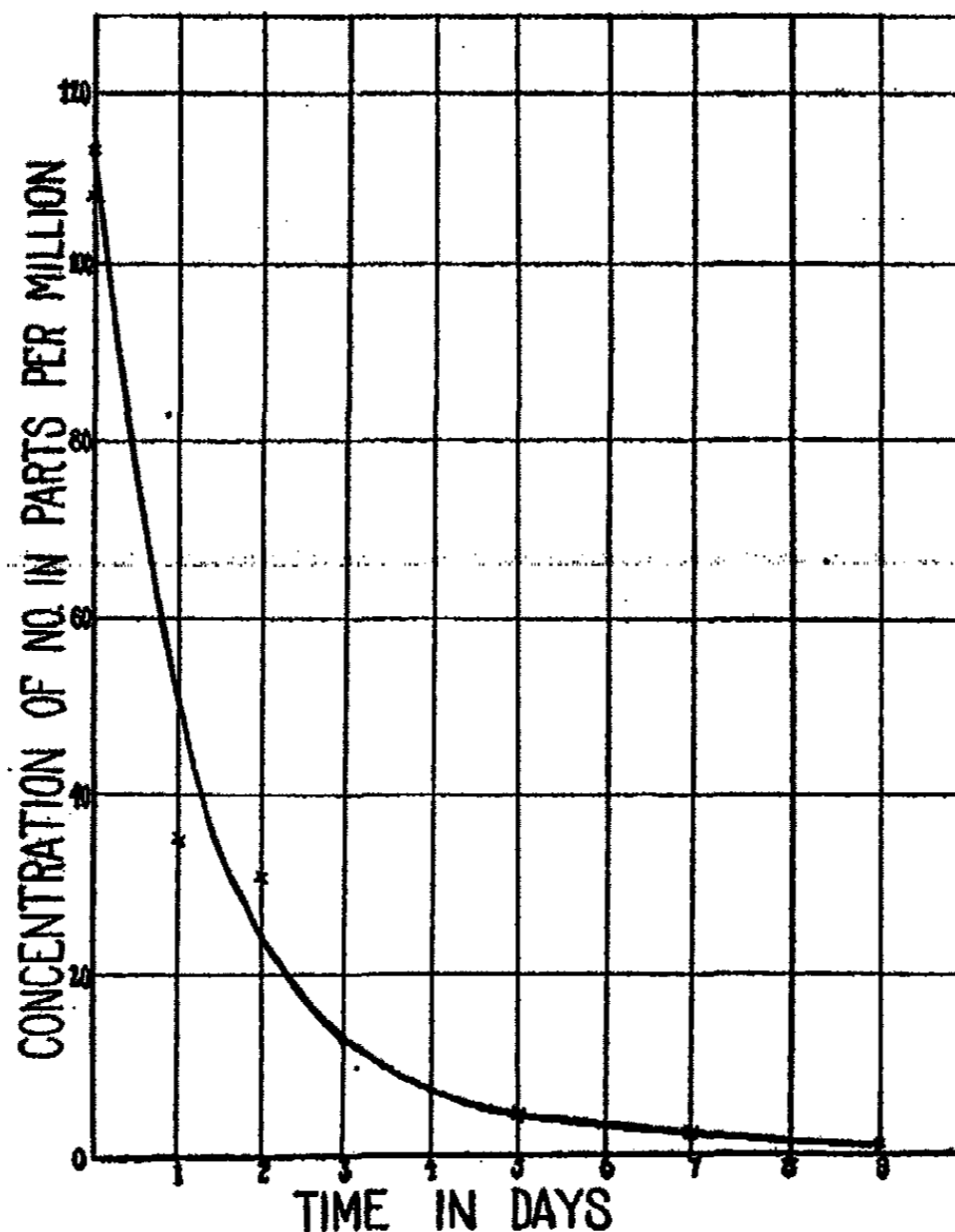

FIG. 10

TABLE VII

Test	Time after mixing	Conc. of NO in pts. per mil.	Test	Time after mixing	Conc. of NO in pts. per mil.
	0	113	4	5 days	4.4
1	1 day	35	5	7 days	2.2
2	2 days	31	6	9 days	1.3
3	3 days	13			

The above results are shown graphically in Fig. 10. Whilst the NO persisted for a longer period than in the previous cylinder, it was obvious that the NO was rapidly disappearing from the cylinder.

There are at least two questions yet to be answered:

1. Does the moisture content effect the removal of the NO? or
2. Does only a limited quantity of NO react with the cylinder; or in other words, if another cylinder containing 1000 parts per million NO in  $N_2O$  were prepared, would all the NO disappear?

That the second question may be possible is suggested by the fact that NO persisted in a cylinder containing 630 parts per million NO in N<sub>2</sub>O after a period of four months.

*The Detection and Estimation of NO<sub>2</sub> in N<sub>2</sub>O.*

NO<sub>2</sub> has been found in N<sub>2</sub>O prepared in America and in England. Some tests which were applied with the results obtained are given below:—

1. Strong smell.
2. Yellow colour imparted to aqueous solution of the gas and also to filter paper held over nozzle of cylinder.
3. Litmus solution turned acid.
4. Starch iodide solution oxidised.
5. Brown ring separating a FeSO<sub>4</sub> solution from a solution of the gas in H<sub>2</sub>SO<sub>4</sub>.
6. KMnO<sub>4</sub> reduced.

The effect of the bad American gas on guinea pigs was also tried with fatal results.

The N<sub>2</sub>O samples which produced the above tests must have contained large amounts of NO<sub>2</sub>. NO<sub>2</sub> in such cases could be estimated by absorbing the gas in concentrated H<sub>2</sub>SO<sub>4</sub> and analysing the solution obtained by (a) reduction to ammonia with Devarda's alloy to give total nitrogen, and (b) KMnO<sub>4</sub> titration to give the total nitrite content.

As a simple test to apply to the gas Prof. Donnan suggested that the Ba(OH)<sub>2</sub> used to detect CO<sub>2</sub> should be acidulated and titrated with KMnO<sub>4</sub> solution. The test in which KI is oxidised by the NO<sub>2</sub> and the I<sub>2</sub> set free is titrated with sodium thiosulphate might also be made quantitative. For detection of very small traces of NO<sub>2</sub>, the author would suggest the application of the colourimetric method for detection of NO described above. Further investigation is necessary to show whether this method may be made suitable for quantitative analysis of NO<sub>2</sub>.

#### Summary

1. The main impurity found so far in cylinder N<sub>2</sub>O is nitrogen. Oxygen is also found, but in much smaller amounts, whilst CO<sub>2</sub> is found in some gases but not in others.
2. The freezing-out method of determining the percentage of uncondensable gas in N<sub>2</sub>O gives reproducible results. With the apparatus used the results were within 0.1-0.2%.
3. The freezing-out method has been compared with the more elaborate method of Baskerville and Stevenson of passing N<sub>2</sub>O and H<sub>2</sub> over hot copper and estimating the water formed. The two methods are in good agreement, and show:—
  - (a) That nitrogen is the only impurity present in large amounts.
  - (b) That the freezing-out method may be taken as a standard for comparing routine methods.

4. In sampling and testing the  $N_2O$  from a cylinder the following points must be observed.

- (a) Position of the cylinder.
- (b) Temperature of cylinder.
- (c) The amount removed.
- (d) Rate of removal of gas from the cylinder. (This should be slow.)
- (e) Wt. of gas in cylinder at the time of sampling. (Especially if all the gas has been removed from one phase.)

5. The percentage of uncondensable gas in the full cylinder was determined by sampling the gas, when the cylinder was heated above its critical point ( $36.5^\circ C.$ ). The results obtained varied from 2-3% for different cylinders.

6. The distribution of uncondensable gas in the liquid and gaseous phases of  $N_2O$  in the cylinder, as the weight of  $N_2O$  in the cylinder decreases, has been determined at  $19^\circ C.$  for the case, where  $N_2O$  is continually removed from the gas phase. In one cylinder 10.3% of uncondensable gas was found in the initial sample from the gas phase. About  $\frac{1}{3}$ rd of the total gas in the cylinder was blown away before the  $N_2O$  attained a purity of 97%.

7. The change of concentration of the uncondensable gas in the gas phase with temperature has been determined and graphed. Results for the same weight of  $N_2O$  in the cylinder for three different temperatures were:

at $20^\circ C.$ the % uncondensable gas	=	6.6%
" " " "	=	8.5%
" " " "	=	11.9%

8. The washing-out methods used prior to this work, where ordinary distilled, tap, or previously boiled out waters were employed, gave in every sample examined the percentage of insoluble gas 2.0-3.0% too high. These high results were due to the waters used not being air free.

9. A new washing-out method, using water boiled out in vacuo, is described. It has been found to give satisfactory results, if time-volume curves are plotted, and if the co-ordinate of the point of inter-section of the straight parts of the curve is taken as the volume of nitrogen in the original sample.

10. That the co-ordinate of this point on the volume axis may be taken as the original volume of nitrogen or oxygen in the sample has been shown experimentally by adding known volumes of nitrogen and oxygen to the original sample, and noting the shift of the point of intersection on the volume axis. The shift corresponded to the volume of gas added whether it was nitrogen or oxygen. A curve approximating to a straight line is obtained by this new method for  $N_2O$  previously purified by the freezing-out method.

11. Of the methods of testing the water for absorbed gases suggested, that of hard bumping has been found sufficient for an experienced worker. Testing the water by analysing a sample of gas of known nitrogen content is the surest method.

12. Three methods for detecting small quantities of NO in  $N_2O$  have been investigated:



- (a) Reduction of  $\text{KMnO}_4$  solution.  
 (b) Formation of nitroxyhaemoglobin with blood.  
 (c) Absorption of gas by  $\text{NaOH}$  and testing for nitrites.
13. Dilute  $\text{KMnO}_4$  solutions are too unstable to be used for detecting small quantities of  $\text{NO}$  in  $\text{N}_2\text{O}$ .
14. The blood test will detect  $\text{NO}$  in  $\text{N}_2\text{O}$  at a concentration of 100 parts per million, when a large sample is taken.
15. The new method of absorbing in  $\text{NaOH}$  and testing for nitrites will detect quantitatively, within 5-10%,  $\text{NO}$  in  $\text{N}_2\text{O}$  at a concentration of 10 parts per million. The nitrites are detected by the Greiss reagent described by Hlosvay. The volume of gas needed for a test by this method is 500 cc.
16. From the results obtained in the above method it is necessary to assume that the reaction is represented by the following equation:—



17. The reaction of  $\text{NO}$  at a concentration of 10 parts per million with excess oxygen is slow, taking 1 hour for 50% of the  $\text{NO}$  to react, and 7 hours for 90%.
18.  $\text{NaOH}$  solutions are better than water for absorbing the products from the reaction of  $\text{NO}$  and  $\text{O}_2$ . A 4N solution of  $\text{NaOH}$  is recommended.
19. Small quantities of  $\text{NO}$  in  $\text{N}_2\text{O}$  contained in a cylinder are not very stable. The gas may, however, persist in a cylinder for four months.
20. Removal of oxygen from the  $\text{N}_2\text{O}$  does not appear to prevent the loss of  $\text{NO}$  in the cylinder.

In conclusion, the author desires to express his thanks to the Anaesthetics Committee of the Medical Research Council for whom this work was done, for their courtesy in allowing him to publish the results, and to Professor F. G. Donnan, F.R.S., under whose direction the research was conducted, for his constant kind assistance and advice.

*The Sir William Ramsay Laboratories of  
 Inorganic and Physical Chemistry,  
 University College, London.  
 January 9, 1930.*

# THE SORPTION OF WATER VAPOR BY CELLULOSE AND DERIVATIVES

## PART II. THE KINETICS OF SORPTION\*

S. E. SHEPPARD AND P. T. NEWSOME

In Part I measurements of the sorption equilibria of cellulose and derivatives with water vapor were described. The present paper deals with some of the velocity phenomena, which may be expected to throw additional light on the sorption process.

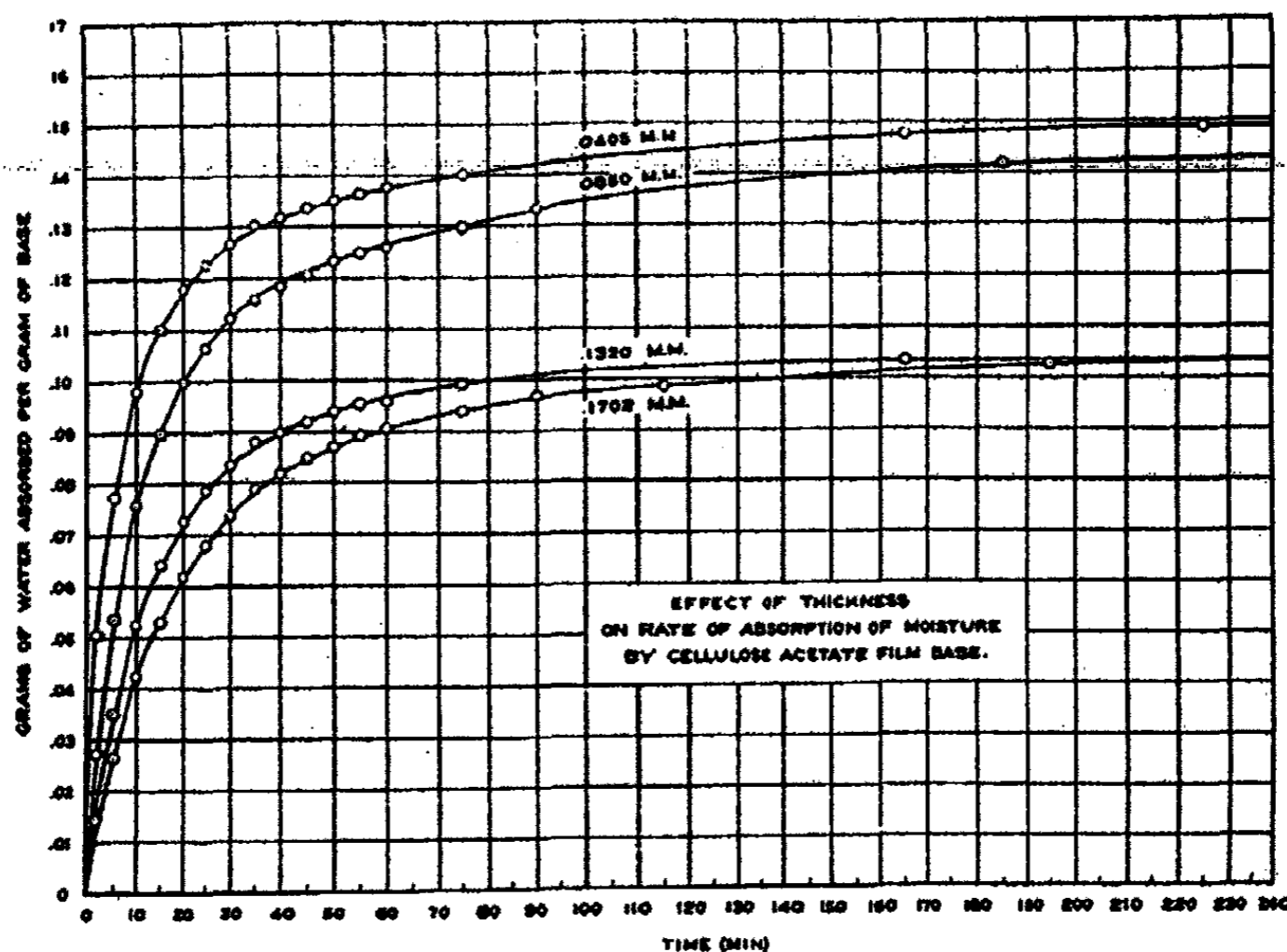

Using the enclosed spring balance already described, observations on the rate of adsorption and desorption are obtained from the curves relating the sorption weight to time at a given vapor pressure.

The data presented deal with pieces of cellulose acetate and nitrate sheets, since these can be prepared in definite thickness, and the coarser structure factors present in the case of fibers and powders are minimized. Even so, it will be shown that a very definite porosity factor is present, and the kinetic measurements are important because of the evidence they give on this.

In Fig. 1 are shown typical curves of the adsorption of water vapor at 25°C. at saturation pressure (23.7 mm.).

\* Communication No. 415 from the Kodak Research Laboratories. Presented at the September meeting of the American Chemical Society, Minneapolis.

In this case four pieces of film of different thickness, prepared by evaporation of an acetone solution of cellulose acetate, were used. These gave somewhat differing values of the maximum adsorption.

Thickness	Maximum Adsorption	Thickness	Maximum Adsorption
0.0405 mm.	14.95% at 600 min.	0.1320 mm.	10.60% at 1290 min.
.0850 "	14.49% " 1320 "	.1702 "	10.79% " 1440 "

It is known that in the case of gelatin gels the maximum water absorption depends upon the concentration of the jelly, and the possibility of a similar effect with the cellulose colloids is being investigated. The samples discussed were prepared from the same solution or dope, and the differences in maximum adsorption cannot be referred to the concentration factor. Although there is some tendency for the thicker films to show a lower adsorption, the drift is not decisive, whereas it will be shown that both the *diffusivity*, and the *density* vary progressively with the thickness.

Since any structure in these transparent films must be ultra-microscopic, it appeared probable that the velocity of adsorption would be determined by *diffusion*, and therefore represented by some form of Fick's diffusion law:

$$\frac{\delta\phi}{\delta t} = K \left( \frac{\delta^2\phi}{\delta^2x} \right)$$

where  $\phi$  represents the concentration of water at distance  $x$  and time  $t$ ,  $k$ , the characteristic diffusivity. The assumptions for its application as pointed out by Andrews and Johnston<sup>1</sup> in their work on the absorption of water by rubber, are:

- I. That the water enters by diffusion only.
- II. That no physical or chemical change occurs by reason of entry of water such as would change the diffusivity.
- III. That the external surface is saturated instantaneously.
- IV. That the water enters through the surface of the sheet (slab) only, the edge areas being negligible.

From these assumptions Andrews and Johnston obtained an integrated form of Fick's equation for a diffusion into a slab or sheet:

$$\frac{Q}{Q_1} = 1 - \frac{8}{\pi^2} \left\{ e^{-\frac{\pi^2 kt}{4a^2}} + \frac{1}{9} e^{-\frac{9\pi^2 kt}{4a^2}} + \frac{1}{25} e^{-\frac{25\pi^2 kt}{4a^2}} + \dots \right\}$$

Where  $Q_1$  = maximum absorption  
 $Q$  = absorption at time  $t$   
 $a$  = 1/2 thickness of sheet  
 $k$  = diffusivity constant

If the quotient  $kt/a^2$  is greater than 0.1, *i.e.*, for values of  $Q/Q_1 > 0.36$ , all terms but the first may be neglected, when the equation reduces to

<sup>1</sup> D. H. Andrews and J. Johnston: J. Am. Chem. Soc., 46, 640 (1924).

$$\frac{Q}{Q_1} = 1 - \frac{8}{\pi^2} e^{-\frac{\pi^2 kt}{4a^2}}$$

Expressed logarithmically

$$\frac{kt}{a^2} = -\frac{4}{\pi^2} \ln \left[ \frac{\pi^2}{8} \left( 1 - \frac{Q}{Q_1} \right) \right] = -0.0851 - 0.933 \log \left( 1 - \frac{Q}{Q_1} \right)$$

If the diffusion law is followed,  $k$  is constant, and the graph of  $-\log \left( 1 - \frac{Q}{Q_1} \right)$  against  $t/a^2$  should be a straight line independent of the thickness.

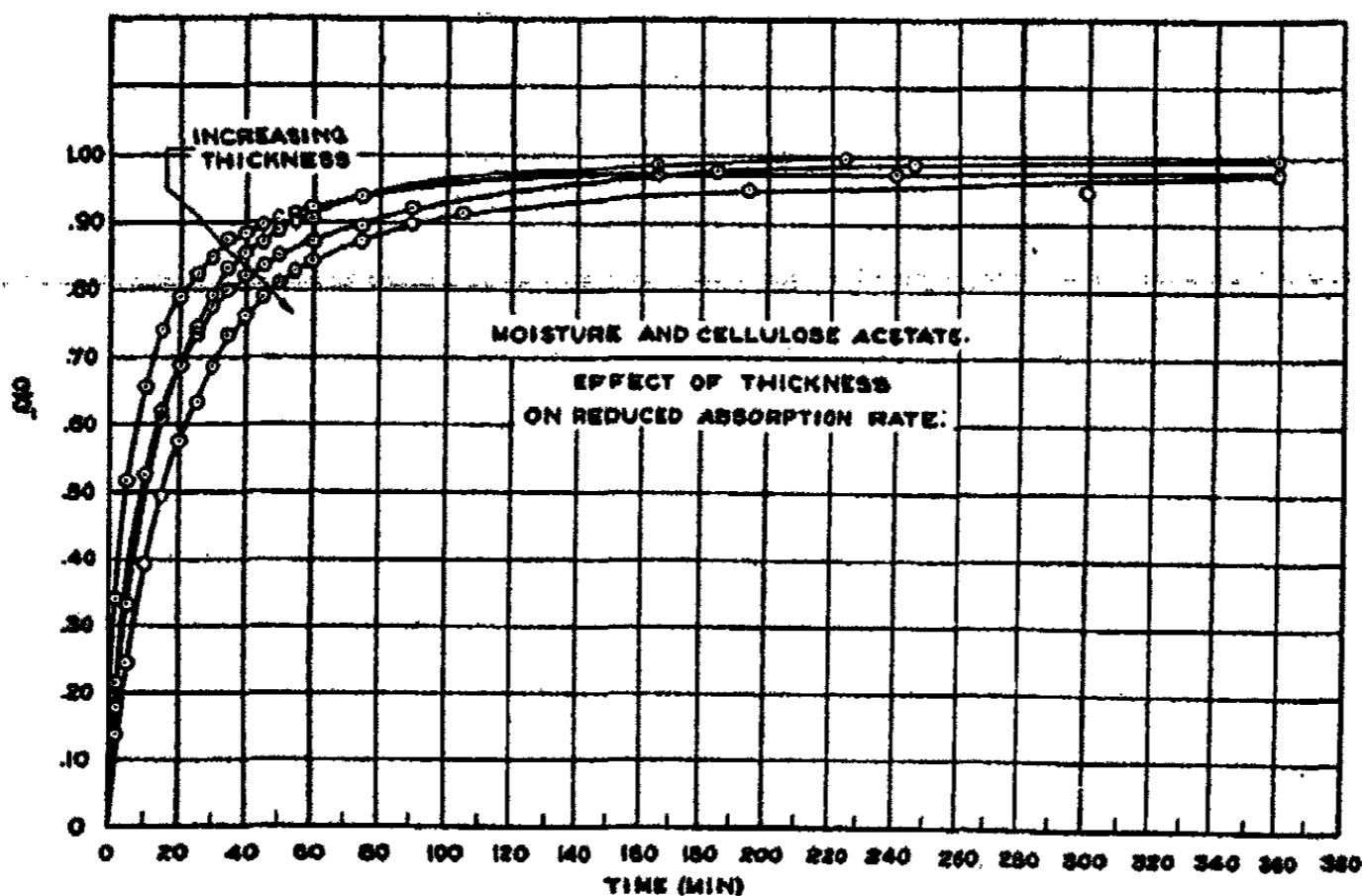

FIG. 2

Actually, when applied to the data of the curves in Fig. 1, the values of  $k$  were constant only for the first 15 minutes (to 58% of total absorption) after which they decreased continuously.

When  $Q/Q_1$  is plotted against  $t$  for the sheets of increasing thickness, we get a series of curves of gradually increasing slope but all approaching the same value of  $Q/Q_1 = 1$  in gradually increasing periods of time; this is in qualitative agreement with the diffusion law. (Cf. Fig. 2.)

It is possible to use the fuller series equation to calculate diffusivity, as follows: The series may be written

$$\frac{Q}{Q_1} = 1 - \frac{8}{\pi^2} \left\{ e^{-\Theta} + \frac{1}{9} e^{-9\Theta} + \frac{1}{25} e^{-25\Theta} \right\}$$

where

$$\Theta = \frac{\pi^2 kt}{4a^2} = \frac{\pi^2 k_1 t_1}{4 a_1^2} \dots$$

In the table are shown values of  $Q/Q_1$  thus calculated for different values of  $\theta$ .

TABLE I

$\theta$	$Q/Q_1$	$\theta$	$Q/Q_1$
0.0	0.0	1.0	0.702
.1	.227	1.5	.820
.2	.321	2.0	.890
.3	.393	3.0	.960
.4	.454	4.0	.985
.5	.507	5.0	.994
.6	.554	6.0	.998
.7	.597	7.0	.999
.8	.636		

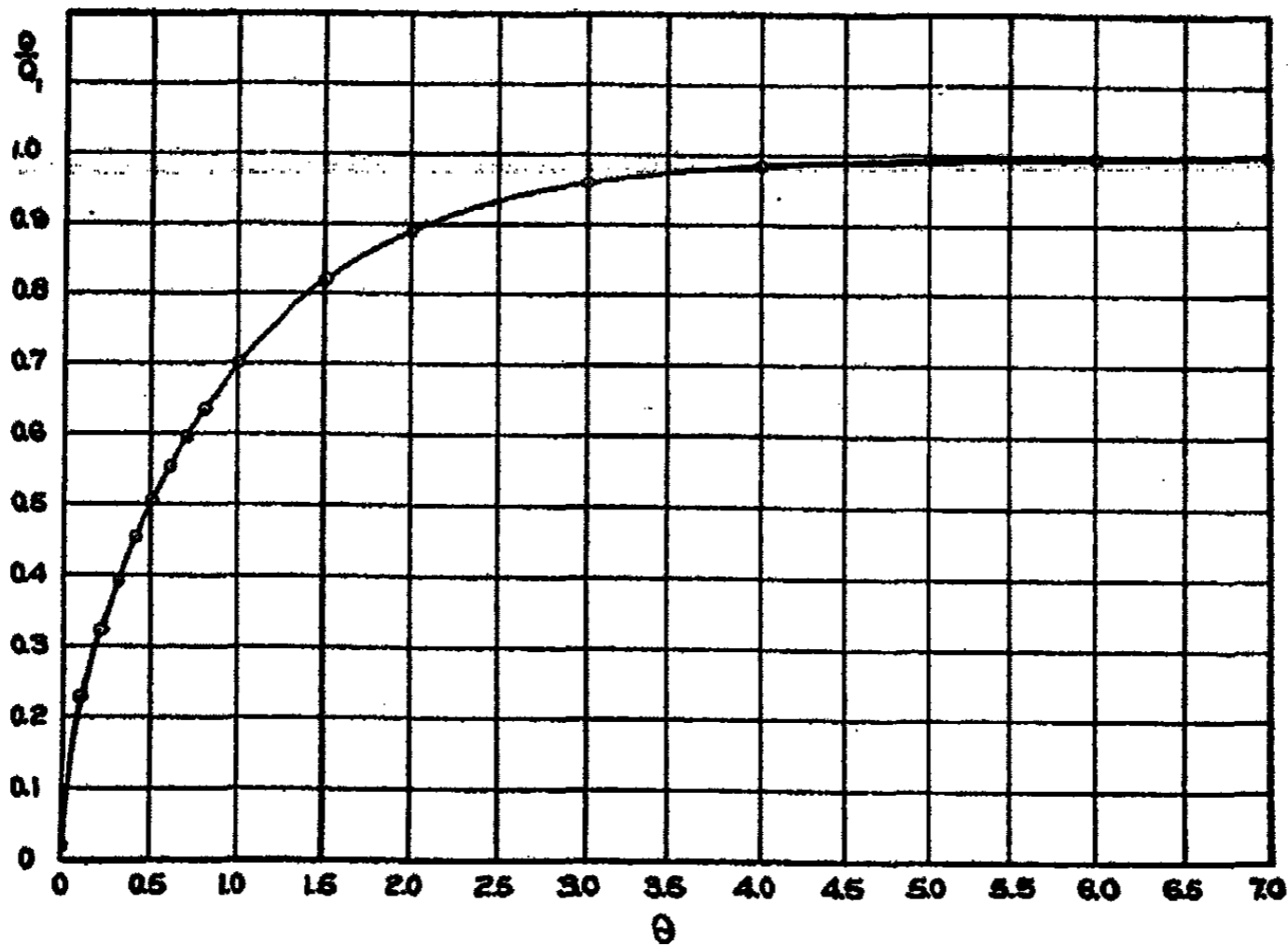

FIG. 3

The graph of  $Q/Q_1$  plotted against  $\theta$  is shown in Fig. 3.

$Q/Q_1$  is a function of the single variable  $\theta$ , whence, from any value of  $\theta$ , the corresponding value of the diffusivity  $k$  can be calculated from the equation

$$\theta = \frac{\pi^2 kt}{4a^2}$$

by using the known values of  $t$  and  $a$ .

It appears that the diffusion law is more nearly followed for the thicker sheets where there is a better approach to constancy of  $k$ . At the same time, the marked variation of  $k$  with thickness indicates a structural difference between the sheets.

TABLE II

Q/Q <sub>1</sub>	$\theta$	0.0405 mm. $k_1 \times 10^{-6}$	0.0850 mm. $k_2 \times 10^{-6}$	0.1320 mm. $k_3 \times 10^{-6}$	0.1702 mm. $k_4 \times 10^{-6}$
0.2	0.083	11.5	33.7	54.3	64.9
.3	.175	17.1	37.7	65.7	77.8
.4	.310	19.8	39.8	77.1	89.2
.5	.488	17.2	39.7	84.4	96.8
.6	.710	15.1	39.1	86.4	97.8
.7	1.000	13.4	34.5	84.0	93.8
.8	1.395	10.8	28.8	80.5	86.2
.9	2.085	7.3	20.2	68.4	83.9

This is borne out by *density measurements* (made by displacement of mercury by evacuated samples).

TABLE III

Thickness	Density	Thickness	Density
0.029 mm.	1.290	0.120 mm.	1.277
.058 mm.	1.283	.135 mm.	1.262

These figures indicate that the thicker films have a somewhat more open structure, in agreement with the increased diffusivity.

The diffusivity  $k = W/\sigma$ , where  $W$  denotes water passing across unit area per second for unit concentration gradient, and  $\sigma$  is moisture absorbing capacity per unit volume. There is some evidence for decrease of  $\sigma$  with increasing thickness, giving an *increase* of  $k$ , but it is not conclusive, hence there appears a real increase in the absolute diffusion rate for the thicker films.

The evidence from this is that the rate of sorption is primarily dependent upon diffusion, but that a structure factor of porosity intervenes, which probably affects the value of  $a$ , the half-thickness, which does not correspond accurately to the apparent, or geometric, thickness.

#### Rate of Transpiration

If the porosity extended to the presence of actual capillaries or canals through the sheet, then the rate of passage of water through such a sheet would depend upon the hydrostatic head or pressure. To test this, and to enable measurements of transpiration or permeability to be made, the sorption balance was arranged as shown in Fig. 4.

The sample of sheet, cut to circular form, is screwed tightly into the metal connection H. The metal parts are sealed to the glass with De Khotinsky cement. The disk of film through which the water can pass is 32 mm. in diameter. C is a glass tube, 36 inches long, containing water. As the water diffuses through the sheet it is absorbed by magnesium perchlorate trihydrate in the aluminium pan E, suspended from the silica spring. Measurements were made at 25°C. F is a mercury manometer open to the atmosphere. E

was opened and closed a few times to insure equilibrium of the absorbent with dry air at atmospheric pressure before admission of water at C. Fig. 5 shows graphs of transpiration at different hydrostatic heads. The slopes of the graphs are practically the same, showing that water diffuses through at a rate independent of the hydrostatic head. This excludes the possibility of continuous capillary canals, through which water might flow according to Poiseuille's law. It does not preclude the film containing capillary pores which are either closed, or open at one end only.

Membranes of cellulose derivatives have been prepared for ultra-filtration purposes which undoubtedly contain continuous pores or capillaries, but a special technic is necessary. Even opaque sheets of cellulose nitrate, which have an evident porous structure (cf. Part I) were found, with this apparatus, to give no effect of hydrostatic head upon the transpiration of water. On examination it was found that the rapid absorption of a fluid such as benzol by this material was confined to one surface, viz., that exposed to the air during evaporation of the solvent. The surface attached to the glass or metal was free from such pores.

This conclusion was extended to the transparent cellulose ester films as follows: The adsorption of water vapor by a piece of cellulose acetate sheet was measured (a) with both surfaces free to adsorb, (b) with one surface only free to adsorb.

The latter condition was effected by sealing one surface with aluminium foil cemented on with rubber cement.

Table IV shows the maximum adsorptions observed.

In Fig. 6 are shown the adsorption-time curves. The lower value of the "one-sided" adsorption appears to indicate the presence of surface pores, which were ineffective in holding water when sealed with rubber cement and aluminium foil.

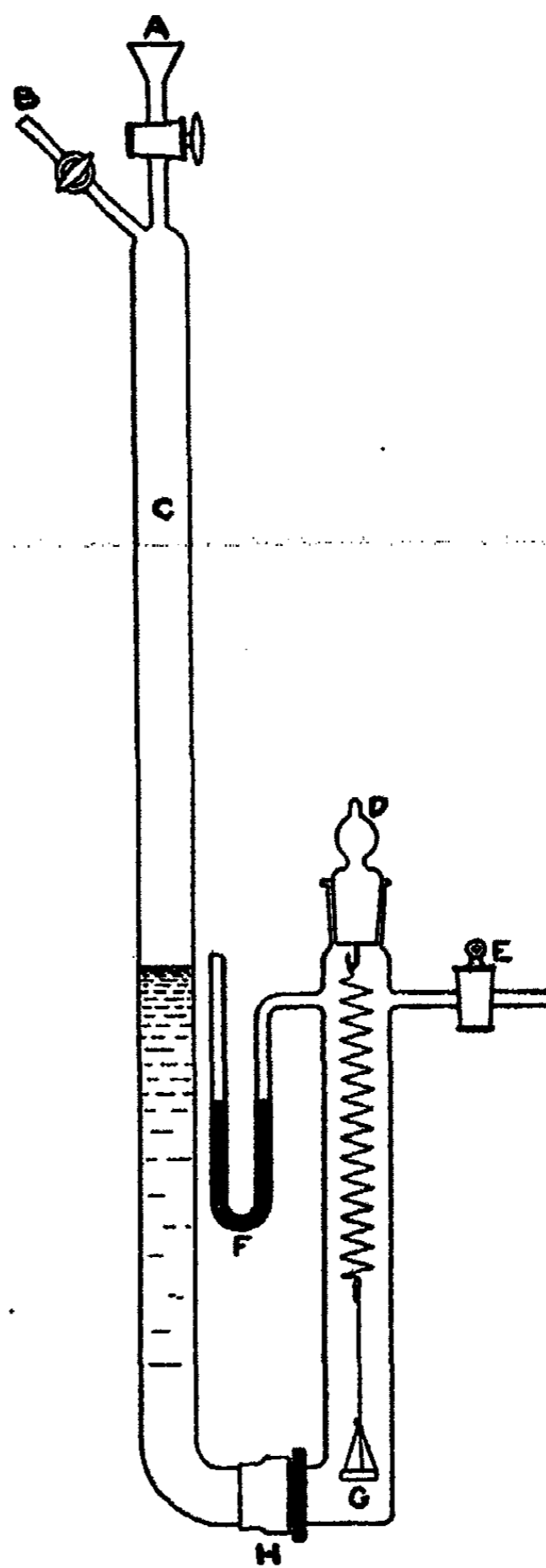

FIG. 4

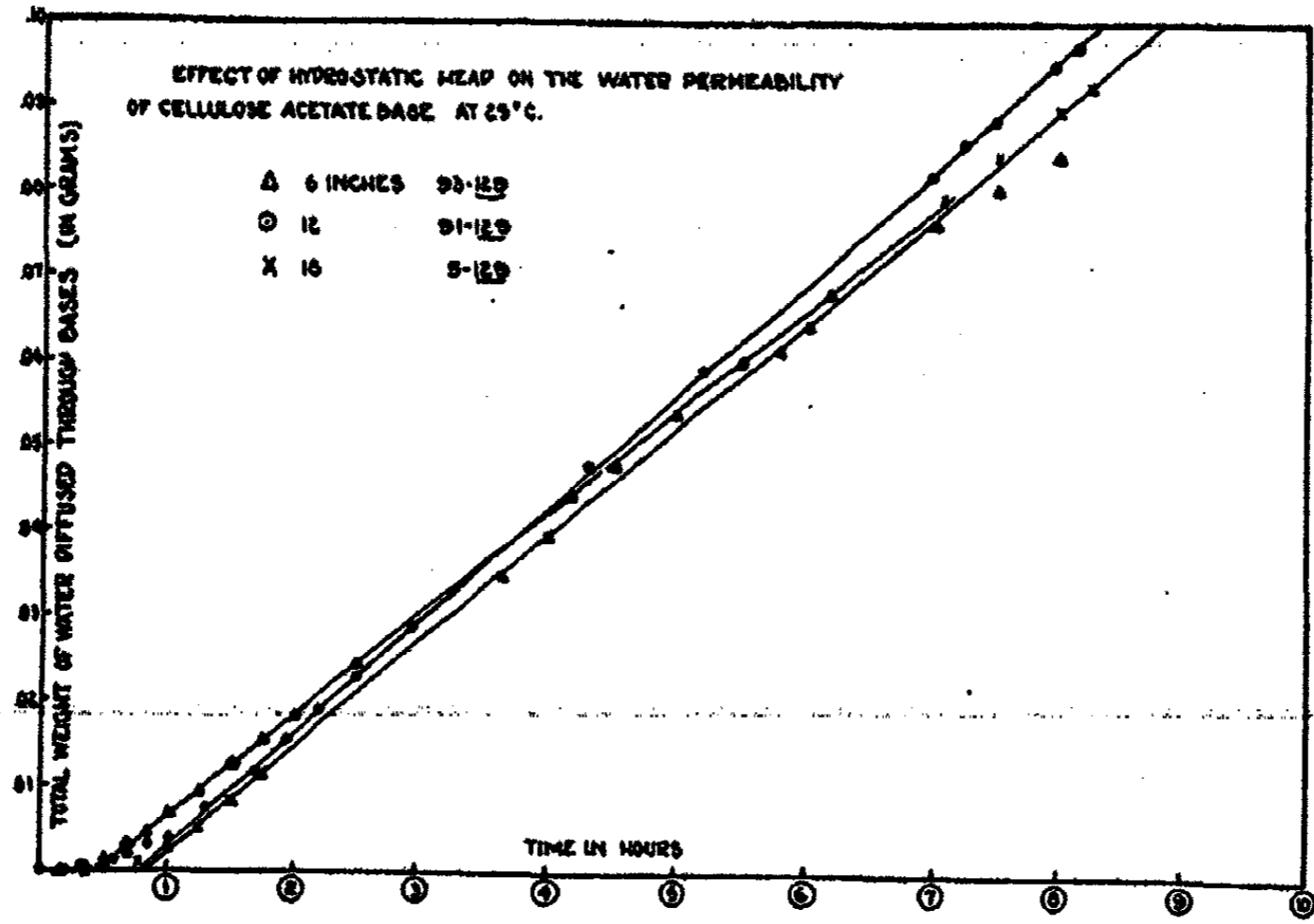

FIG. 5

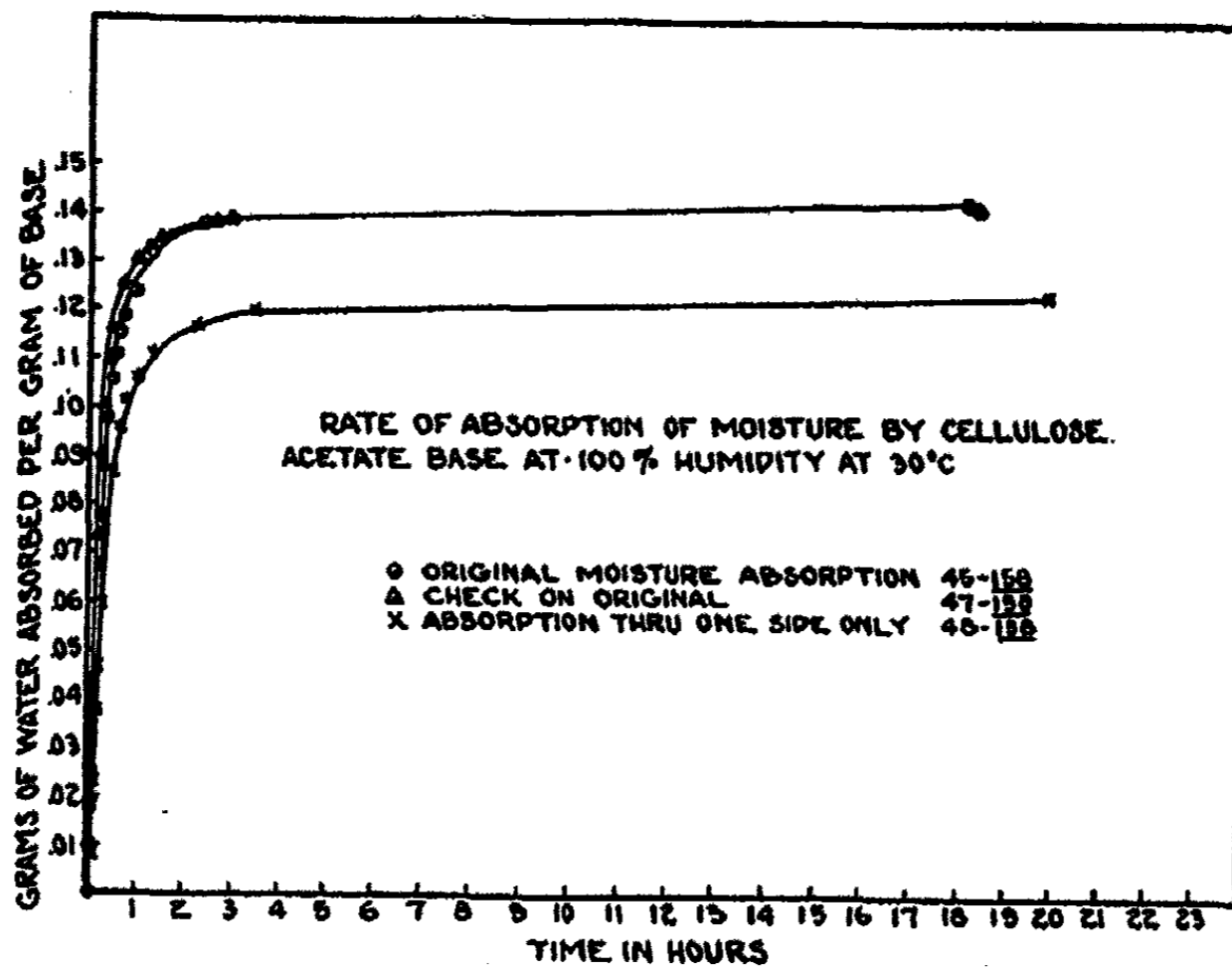

FIG. 6



TABLE IV

Experiment	Per cent Water Adsorbed at Equilibrium
1. Adsorption from both sides	14.25
2. Check	14.16
3. Adsorption from one side	12.50
4. Check	12.39
5. Adsorption from both sides after removal of aluminium foil	14.05

The results of these experiments are in good agreement with the conclusions reached in Part I of this series regarding the nature of the sorption.

There appear to be two principal stages or aspects of the sorption. One consists in the attachment of water (or other polar) molecules to free hydroxyls of the cellulose molecule, *i.e.*, to cellulose hydroxyls which are not mutually satisfying each other. It appears evident that only a certain number of the cellulose hydroxyls are free to exert this attraction for water, because if each hydroxyl were free to the extent of binding only one H<sub>2</sub>O molecule, then cellulose could take up some 33 per cent water, whereas even "hydrate cellulose" takes up only some 23 per cent, "native" cellulose only 16 to 18 per cent. Moreover, of this water actually adsorbed, it is evident that a considerable, but variable portion is held under varying constraint and evidently corresponds to liquid held in pores or capillary spaces. The nuclei for "filling" these pores are provided by the surface hydroxyls, so that the two processes are closely interrelated. Also, since cellulose colloids do not form completely rigid, but elastic gels, which deform and swell on adsorption, it is probable that the ratio of free hydroxyls to bound hydroxyls increases with adsorption of water, and decreases again on desorption, with a concomitant change of the "pore space." This is in agreement with the reduced mechanical strength on increased adsorption. On this view it is comprehensible why the kinetics of the process are largely but not completely, those of a diffusion process. The movement of water through a cellulose gel is primarily a random molecular movement, but complicated by secondary anchorages of water molecules which cause local floodings and surges. The exact geometrical conditions of the diffusion equation are not maintained, therefore, the material being more heterogeneous, more coarse-grained, than is assumed, and this "graininess" actually changes with the progress of the sorption itself, so that the total diffusion path is not constant.

*Rochester, N. Y.*  
*November 15, 1929.*

# THE HOMOGENEOUS DECOMPOSITION OF GASEOUS ACETALDEHYDE\*

BY LOUIS S. KASSEL\*\*

## Introduction

The number of gas reactions which have been found to follow a simple second order equation in all their details is very limited. Among the reactions more or less commonly called second order, but which are not exactly so, may be listed the decomposition of chlorine monoxide, the formation of hydrogen sulfide, the formation and decomposition of nitric oxide, and the decomposition of ozone. In all of these reactions, there seems to be some step which is actually bimolecular, so that the kinetics resemble those of a second order reaction; but the decomposition of ozone is known to be a chain reaction of complex character,<sup>1</sup> the decomposition of chlorine monoxide proceeds in several steps, and it too may be a chain reaction,<sup>2</sup> the formation of hydrogen sulfide is complicated by the various polymers in which sulfur occurs, and the reactions involving nitric oxide apparently involve some catalysis by the walls. Only the formation and decomposition of hydrogen iodide<sup>3</sup> and the decomposition of nitrous oxide<sup>4</sup> may be considered as exactly second order, and provisionally assigned a simple bimolecular mechanism.

The decomposition of acetaldehyde has been reported second order by Hinshelwood and Hutchison<sup>5</sup> although their experiments showed that there was some disturbing influence which apparently became greater at low pressures. These authors found also that the addition of much powdered silica to their reaction vessel produced a slight increase in rate, and hence they concluded that the low pressure disturbance was due to a wall reaction. The writer<sup>6</sup> was able to show that their measurements were consistent with the assumption that the decomposition of acetaldehyde occurred by simultaneous independent first and second order processes, and it was shown that such behavior was understandable theoretically. The present investigation was undertaken with the hope of verifying this hypothesis and determining the rate and temperature coefficient of the first order component of the reaction. It was found, however, that the explanations of Hinshelwood and Hutchison, and of the author, were both incorrect, that there is no satisfactory evidence that any component of the decomposition is second order, and in fact that the reaction is more complex than had previously been supposed.

## Experimental Arrangements

The furnace used was built around a heavy hollow copper block, containing the reaction vessel. Three heating coils of nichrome wire, at the top, sides, and bottom of the block, were used. The block and coils were mounted in

\* Contribution from Gates Chemical Laboratory, California Institute of Technology.

\*\* National Research Fellow in Chemistry.

an iron can, which set in a larger one; the three-inch space between the two cans was filled with Sil-O-Cel. Three chromel-alumel thermocouples were set inside the copper block, near the top, middle and bottom of the hollow, and external resistances in series with the heating coils were separately adjusted until the three couples agreed within  $0.2-0.3^{\circ}\text{C}$ . When the furnace was operating at about  $500^{\circ}\text{C}$  about 600 watts were consumed, a considerable part of this power being dissipated by the external resistances. No thermostatic device was used. The heat capacity was so great that during intervals of half an hour the temperature would never change by more than  $0.2^{\circ}$  due to a change in the line voltage; the longer runs were made in the evening, when both the line voltage and the room temperature were quite constant, and no difficulty in maintaining a steady temperature was experienced.

In most of the experiments the reaction vessel was a quartz flask of 300 cc. volume, connected to the rest of the line by a quartz-pyrex graded seal outside of the furnace. In a few runs a pyrex flask of the same size was used.

The acetaldehyde was obtained by distillation of an Eastman product under reduced pressure; it was stored in a bulb sealed to the apparatus, and admitted to the reaction vessel through a stopcock.

Two McLeod gauges were used during the experiments; the first had a bulb volume of about 2.5 cc.; the second one, which was used in most of the experiments had a volume of 5.7 cc.; the capillaries in these gauges were long enough so that when the mercury was run up into the evacuated gauge before the experiment was begun, the gauge could be used as a manometer for pressures up to about 60 cm. For some of the experiments a very tall manometer, capable of reading pressures of several atmospheres, was used. During all of the runs, the reaction system, consisting of the vessel in the furnace and the manometer, was separated from the rest of the apparatus by a mercury cut-off.

No provision was made for admitting a measured amount of acetaldehyde to the reaction vessel. When the half life was short the final pressure was measured, and the initial pressure calculated from it; when the reaction was slower, the pressure could be measured soon after the start and extrapolated back to zero time with sufficient accuracy. In some experiments both initial and final pressures were measured, and it was found that the increase was about 95%; this is due in part to the external volume of the apparatus, in part perhaps to side reactions; Hinshelwood and Hutchison, with a negligible external volume, found a 98% increase.

### Results

The first experiments were calculated using a second order equation, and second order constants were actually obtained. These constants increased as the runs were made at lower pressures, but not as rapidly as had been expected; there was no evidence that the reaction was tending toward the first order, at pressures down to 1 mm. It was then found that the calculated second order constants varied with the inverse cube root of the initial pressure, except at the lowest temperature. It was also noticed that Hinshelwood and

Hutchison's experiments showed the same dependence of rate on pressure; since their pressure range was only eight-fold, it is impossible to determine uniquely from their results the functional form of the pressure dependence; the present experiments extend over a pressure range of 1000-fold, and leave very little doubt as to the correct form.

The facts would suggest that the reaction is of the  $5/3$  order. The single runs, however, are definitely in better agreement with a second order equation than with a five-thirds order one. At pressures near 250 mm., where the accuracy of the experiments was the greatest, there is no question whatever that the second order equation best expresses the results of individual runs; at the lowest pressures used, about 1 mm., the difference is not so great, but the second order equation still seems superior. Thus it is not possible to report the results in terms of true five-thirds order constants, and it does not seem desirable to use the false second order constants which can actually be calculated for the separate runs. It has seemed best to give merely the time required for a definite fraction of the reaction to take place. These times are given in Table I. Runs made at neighboring temperatures have been grouped together. For the purpose of correcting the results to the same temperature it has been assumed that the temperature dependence of the rate is correctly given by Hinshelwood and Hutchison's equation

$$k_2 = 5.5 \times 10^{10} \sqrt{T} e^{-E/RT}$$

The product  $k_2 \Delta t$  should be independent of temperature; if the reaction were second order it would be inversely proportional to  $p$ , but it is found, by plotting  $\log k_2 \Delta t$  against  $\log p$  as in Fig. 1 and measuring the slope of the resultant straight line, that  $k_2 \Delta t$  is inversely proportional to the two-thirds power of  $p$ , as is also shown by Table I.

It will be noticed that the runs made near  $790^\circ$  have been divided into two groups. The first of these includes the earliest runs which are reported here; after this series was completed, the furnace was rebuilt, and the thermocouples arranged somewhat differently. As may be seen from the values in the sixth column, the rates observed after this change were greater than those found before, but the pressure dependence of the two series is the same within the experimental error. With the exception of this first series, the variation in the values in the sixth column is quite erratic, and therefore within the experimental error, except for the two runs at  $720^\circ$  made at the lowest pressures, 0.25 cm. and 0.10 cm., approximately. These show rates several times greater than would have been expected, and it is very probable that under these conditions a wall reaction is becoming important. The runs made at  $740^\circ$  used a pyrex reaction vessel of the same volume as the quartz one of the other experiments, packed with broken tubing to give a six-fold increase in the surface-volume ratio. These runs seem to show that at this temperature a wall reaction is not of importance.

With the exception of the first series at  $790^\circ$  the rates observed in these experiments are about twice as great as those found by Hinshelwood and Hutchison. This is probably due to a difference in the zero of the temperature

scales. The break after run 25 suggests that the error is in the present experiments rather than in those of Hinshelwood and Hutchison. The consistency of the results shows that the error must have been fairly constant, and therefore of minor importance.

Since the separate runs do not correspond to the five-thirds order, it is awkward to give a simple equation which expresses the results. Perhaps the best that can be done is to report the five-thirds order constant which gives

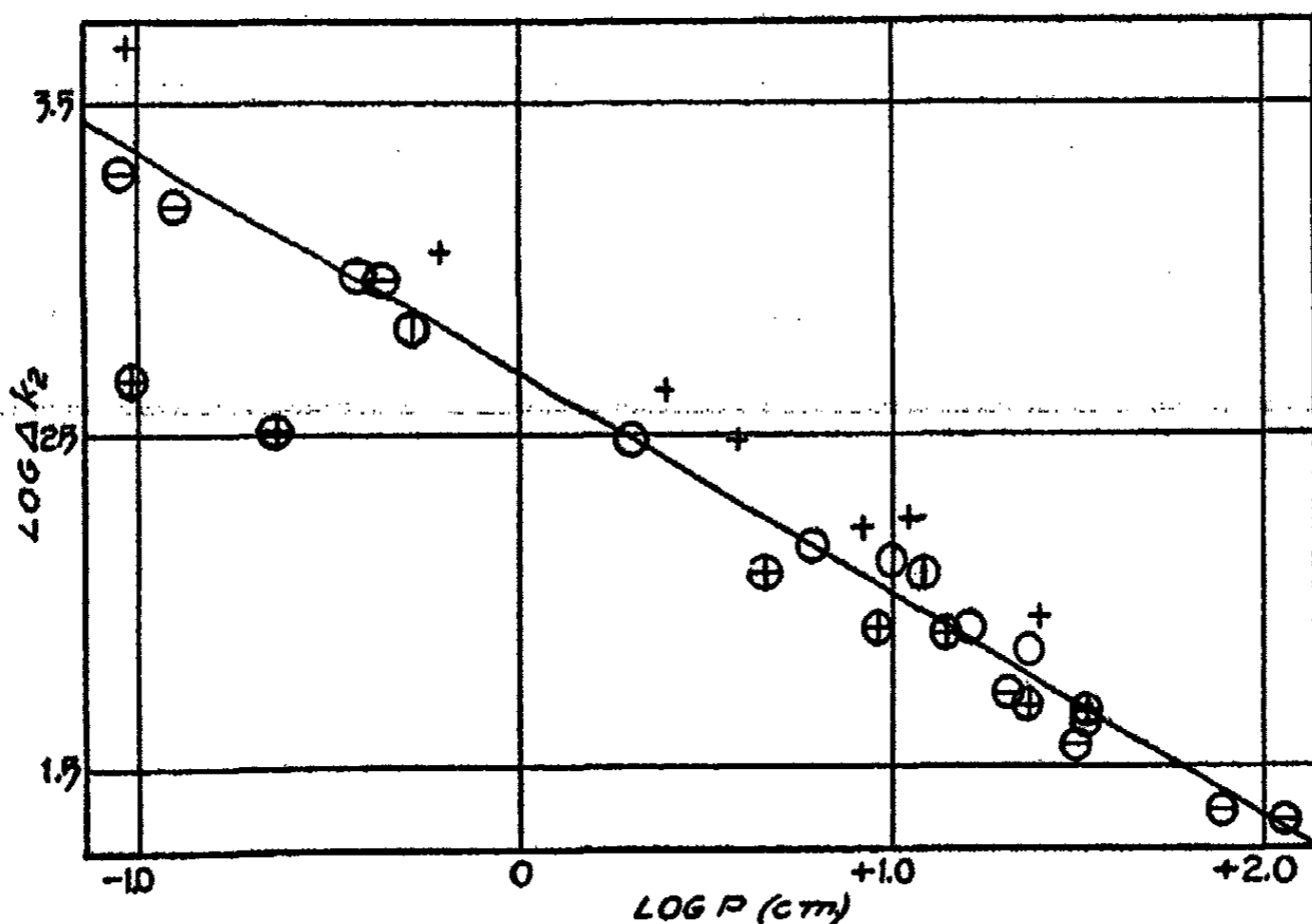

FIG. 1

+ 790° first series                      ○ 790°, second series  
 ⊖ 760°                      ⊙ 740°                      ⊕ 720°

The slope of the straight line is  $2/3$ . It evidently represents satisfactorily the second series at 790°, and the runs at 760° and 740°.

the correct initial rate; the rate during the run will then fall off faster than this constant indicates. We see from Fig. 1 that at 1 cm. pressure the value of  $k_2\Delta t$  is 470. The initial rate is easily calculated in terms of  $\Delta t$ , assuming a second order course for the reaction; it is  $0.556/\Delta t$  in cm/sec. at 1 cm. pressure. Taking a mean temperature of 700°K, we find that 1 cm. pressure corresponds to  $2.08 \times 10^{-7}$  moles/cc.; hence an initial rate of  $y$  cm/sec. at a pressure of 1 cm. gives a five-thirds order constant of  $y(2.08 \times 10^{-7})^{-2/3}$  or  $2.8 \times 10^4 y$  in  $(\text{cc}/\text{moles})^{2/3} \text{sec}^{-1}$ . Combining these results, and again using Hinshelwood and Hutchison's value for  $k_2$ , we obtain

$$k = 1.8 \times 10^{12} \sqrt{T} e^{-46600/RT} (\text{cc}/\text{moles})^{2/3} \text{sec}^{-1}$$

as the five-thirds order constant which gives the initial rates. This is on the author's temperature scale, so that the correct value is perhaps about half

TABLE I  
Experiments near 790°K

Run No.	T	$\Delta t = t_{40} - t_{10}$	$k_2$ (Hinsh)	log p (cm)	$\log k_2 p^{2/3} \Delta t$	$\log k_2 p \Delta t$
19	786.3°	255 <sup>0</sup>	0.346	1.40	2.88	3.35
16	798.3	320	0.541	1.04	2.93	3.28
15	790.0	405	0.411	0.91	2.82	3.12
18	785.5	900	0.336	0.59	2.87	3.07
22	784.4	1359	0.322	0.38	2.89	3.02
23	787.6	3126	0.363	-0.21	2.90	2.85
24	793.4	10100	0.451	-1.03	2.97	2.63
49	802.1	115	0.621	1.37	2.76	3.22
47	791.1	197	0.419	1.22	2.73	3.14
48	794.3	283	0.467	1.00	2.79	3.12
50	804.2	223	0.670	0.78	2.69	2.95
51	794.3	667	0.467	0.30	2.69	2.79
52	792.9	2172	0.443	-0.41	2.71	2.57
Experiments near 760°K						
62	762.2	156	0.136	2.06	2.70	3.39
61	761.9	170	0.134	1.88	2.61	3.24
57	756.9	135	0.109	1.79	2.36	2.96
56	756.3	407	0.107	1.53	2.66	3.17
60	758.0	319	0.115	1.50	2.56	3.06
38	754.9	522	0.101	1.42	2.67	3.14
39	756.6	8583	0.108	-0.36	2.73	2.61
37	760.0	12400	0.124	-0.89	2.60	2.30
36	757.2	17700	0.111	-1.04	2.60	2.25
Experiments near 740°K Pyrex flask added surface						
65	741.4	2093	0.0575	1.08	2.80	3.16
66	743.5	10410	0.0630	-0.29	2.63	2.53
Experiments near 720°K						
41	725.1	1610	0.0284	1.53	2.68	3.19
40	724.0	1760	0.0271	1.37	2.59	3.05
42	719.7	3550	0.0224	1.14	2.66	3.04
43	721.5	3350	0.0242	0.96	2.55	2.87
44	719.9	5450	0.0226	0.66	2.53	2.75
46	718.9	15380	0.0216	-0.63	2.10	1.89
45	720.9	19530	0.0236	-1.01	1.99	1.65

In this table the first column gives the number of the run, the second the absolute temperature at which it was made, the third the time in seconds for 40% transformation minus that for 10%, the fourth the calculated second order constant from Hinshelwood and Hutchison's equation, the fifth the common logarithm of the initial pressure in cm. of Hg; the values in the sixth column would be constant for a five-thirds order reaction, those in the seventh column constant for a second order reaction.

of this. Since the values in column six of Table I are independent of temperature, Hinshelwood and Hutchison's value for the temperature coefficient is confirmed by the experiments.

In the course of the experiments an interesting incidental observation was made. The earlier design of the apparatus was such that it was occasionally possible for a drop of mercury to reach the reaction flask; of course, it would always distil out again. Whenever this occurred, the reaction was modified in several ways: the order during a run shifted from second to first; the rate, at the temperatures and pressures used, increased greatly; the temperature coefficient became quite small, the rate remaining measurable down to 450°K or even less; and the pressure of the reaction products was not twice, but about four times the initial pressure. It was also found that the reaction products were strongly adsorbed below 450°K. When the flask was taken out and cleaned with nitric acid and distilled water, these phenomena all disappeared; in particular, it was shown that the reaction products were not adsorbed. All of the foregoing facts except the fourfold increase in pressure are normal catalytic effects; but it is not possible to construct more than three moles of gas out of one mole of acetaldehyde. The vapor density of the acetaldehyde as it entered the reaction vessel was shown to be normal. Adsorption of the acetaldehyde vapor is not a promising explanation, since about the same increase is found whether the initial acetaldehyde pressure is measured at 500 or 800°K, the final pressure being read at the higher temperature in either case. A possibility is the oxidation of the acetaldehyde by the residue left in the bulb, making the second carbon atom into a gaseous molecule. Unfortunately there was no opportunity to study further this aspect of the reaction. Since the conditions for its appearance are so well defined and the deviations from the usual behavior which it causes are so great, there seems to be no chance that the results of the main investigation are at all affected by the possibility of this catalytic reaction.

#### Discussion

The outstanding features of the decomposition, so far as can be seen from the combined work of Hinshelwood and Hutchison and of the author are the following: the initial rates of reaction, or the times for definite fraction of the reaction to take place, are given quite exactly by an equation of the five-thirds order; the rate during a single run decreases faster than would be expected from such an equation, and seems to follow quite closely a simple second order equation; this suggests some sort of retardation by the reaction products, but Hinshelwood and Hutchison found that the reaction products were quite without influence on the rate; the reaction seems to be chemically simple, since the pressure very nearly doubles, and the final products, according to Hinshelwood and Hutchison, are nearly equal amounts of carbon monoxide and methane. It should be emphasized that the only discrepancy between the actual experimental results of Hinshelwood and Hutchison and those of the author is in the zero of their temperature scales, which is relatively important.

It is quite possible to invent a mechanism which predicts that the initial rate shall correspond to a five-thirds order reaction, and that the rate during the run shall decrease faster than for a pure five-thirds order reaction. But to make these predictions without sacrificing other requirements, such as the relative unimportance of side reactions, appears to be a much more difficult task. For a mechanism which can give a fractional order can scarcely avoid the introduction of radicals such as  $\text{CH}_3$ ,  $\text{CH}_2$ ,  $\text{OH}$ ,  $\text{HCO}$  or others of a similar nature; and the appearance of these radicals would be expected to result in the formation of a wide variety of products. It seems undesirable to give any mechanism which must arbitrarily forbid unwanted reactions between the substances on which it is based, and accordingly no mechanism is suggested for this reaction.

It now becomes necessary to reconsider the ideas<sup>6</sup> which led the writer to undertake this work. At that time reasons were given for believing that every unimolecular reaction should be accompanied by a bimolecular side reaction with about the same energy of activation. Since we know how to calculate in an empirical way the approximate rate to be expected for a bimolecular gas reaction with a given energy of activation, it was easy to show that for all of the known unimolecular reactions this additional bimolecular part would contribute a negligible amount to the rate. It was also shown that the work of Hinshelwood and Hutchison agreed with the supposition that in the decomposition of acetaldehyde the two rates were of comparable magnitude, the bimolecular one becoming dominant at pressures above 100 mm. Since a molecule as complex as acetaldehyde should have been expected to decompose unimolecularly, this resolution of the rate into two parts seemed satisfactory. It has now been shown that these ideas have no application to acetaldehyde, the actual mechanism of reaction being of complex character. This merely means that there is some more complex path by which the reaction can take place with the greatest speed; there is no reason to suppose that simple unimolecular and bimolecular methods of decomposition are not simultaneously occurring.

At one time the work of Riesenfeld and Schumacher<sup>7</sup> seemed to show that the chief mechanism of the ozone decomposition at low pressures was unimolecular, but more recent work shows that while there is a first order reaction which becomes important at low pressures, its rate is depressed by inert gases to an extent quite impossible for a pure unimolecular decomposition. This would have been but an imperfect example in any case, since the reaction mechanism dominant at high pressure is a chain and not a simple second order reaction.

Thus at the present time there are no examples known of unimolecular reactions whose accompanying bimolecular parts are large enough to have been detected. It would be possible to regard the increase in rate of decomposition of nitrogen pentoxide<sup>8</sup> and pinene<sup>9</sup> in solution as compared with the gas phase as due to the bimolecular reaction between nitrogen pentoxide or pinene and solvent. But in such condensed systems, where the concept of



collision has become almost meaningless, this explanation of the increase would be but little different from the more common one of perturbation by the intense fields of neighboring molecules.

#### Summary

1. The homogeneous decomposition of acetaldehyde vapor has been studied over a wide range of pressure. The dependence of rate on initial pressure is that of a five-thirds order reaction, but the variation in rate during a single run can better be expressed by a second order equation.

2. A heterogeneous reaction which is first order and which can be measured at much lower temperatures than the homogeneous reaction has been detected under special conditions. The pressure increase resulting from this reaction is 300%, compared with 100% for the homogeneous reaction.

3. The idea which the writer had previously advanced that all unimolecular decompositions should be accompanied by a bimolecular decomposition of the same substance is at present without experimental confirmation. Since for all the known unimolecular decompositions, the expected bimolecular companion reaction has a predicted rate too small to be detected, there seems no reason to abandon the idea.

#### References

<sup>1</sup> Riesenfeld and Wassmuth: *Z. physik. Chem.*, **143**, 397 (1929). References to previous work given there.

<sup>2</sup> Hinshelwood: "Kinetics of Chemical Change in Gaseous Systems."

<sup>3</sup> Bodenstein: *Z. physik. Chem.*, **29**, 295 (1899).

<sup>4</sup> Hinshelwood and Burk: *Proc. Roy. Soc.*, **106A**, 284 (1924).

<sup>5</sup> Hinshelwood and Hutchison: *Proc. Roy. Soc.*, **111A**, 380 (1926).

<sup>6</sup> Kassel: *J. Am. Chem. Soc.*, **50**, 1344 (1928).

<sup>7</sup> Riesenfeld and Schumacher: *Z. physik. Chem.*, **138A**, 268 (1928).

<sup>8</sup> Lueck: *J. Am. Chem. Soc.*, **44**, 757 (1922).

<sup>9</sup> D. F. Smith: *J. Am. Chem. Soc.*, **49**, 43 (1927).

*Pasadena,  
California.*

19-76.

## THE INFLUENCE OF NITROGEN GAS UPON THE ORGANIC CATALYSIS OF NITROGEN FIXATION BY AZOTOBACTER\*

BY DEAN BURK

The influence of varying the pressure of nitrogen gas on *Azotobacter* has received little attention beyond the recent preliminary work of Meyerhof and Burk<sup>1</sup> (1928). Söhngen<sup>2</sup> (1913) concluded that the beneficial action of colloidal silica and raw humus in promoting growth is owing to the fact that these colloids absorb nitrogen and oxygen, making them more readily available. Allen<sup>3</sup> (1919) has thrown a reasonable doubt upon this possibility. Hunter<sup>4</sup> (1923) concluded that the marked increase in growth rate obtained by aerating cultures was chiefly the result of increasing the nitrogen and oxygen supply, and presumably, thereby, their availability. Apart from a number of equally likely explanations, this conclusion does not seem probable in view of the work of Meyerhof and Burk (1928) and the work reported in this paper, since (1) increasing the pressure of nitrogen to several atmospheres does not proportionately increase the growth rate as compared with that at 0.8 atmosphere; (2) the rate of nitrogen consumption in air is so slow that even in unaerated cultures the culture medium must always be in practical equilibrium with the 0.8 atmosphere of nitrogen; (3) above an equilibrium concentration of 0.05 atmosphere of oxygen, the growth rate is markedly decreased; and (4) growth is as rapid in cultures aerated with nitrogen containing 0.008 atmosphere of oxygen as with nitrogen containing 0.21 atmosphere of oxygen.

### I. Methods

Nitrogen gas studies with micro-organisms have been handicapped heretofore by the lack of a suitable technique. Recently, however, quantitative physico-chemical manometric micro-methods for studying cell metabolism, especially oxygen consumption, have been well worked out and described by Otto Warburg<sup>5</sup> (1926). Figs. 1 and 2 show the particular type of manometer and vessel used by the writer. The total volume of the vessel, measured to the level of the manometric fluid (Brodie solution), is about 16 cc., 2.00 cc. of which are occupied by the culture medium. The alkali cup contains 0.30 cc. of 2 N NaOH, which effectively removes CO<sub>2</sub> as it is formed in respiration, so that the manometer readings, multiplied by a constant, give directly the number of cmm. of oxygen consumed with a usual accuracy of  $\pm .5$  cmm. The

\* From the Bureau of Chemistry and Soils, Washington, D. C., and the Department of Physiology and Biochemistry, University College, London.

<sup>1</sup> Meyerhof and Burk: *Z. physik. Chem.*, A139, (Haber Festschrift-Band), 117 (1928).

<sup>2</sup> Söhngen: *Centr. Bakt.* II, 38, 621 (1913).

<sup>3</sup> Allen: *Ann. Mo. Bot. Gard.*, 6, 1 (1919).

<sup>4</sup> Hunter: *J. Agr. Res.*, 23, 665 (1923).

<sup>5</sup> Otto Warburg: "Ueber den Stoffwechsel der Tumoren," pp. 1-11 (1926).

constants vary from 1 to 2, and are characteristic for each vessel, depending upon the temperature, volume of culture medium, volume of gas, the Bunsen absorption coefficient of the gas concerned, and the normal pressure of the manometric fluid. Under ordinary atmospheric conditions, nitrogen consumption owing to fixation is less than 1% of the oxygen consumption, and may be neglected. But under experimental conditions of very low oxygen

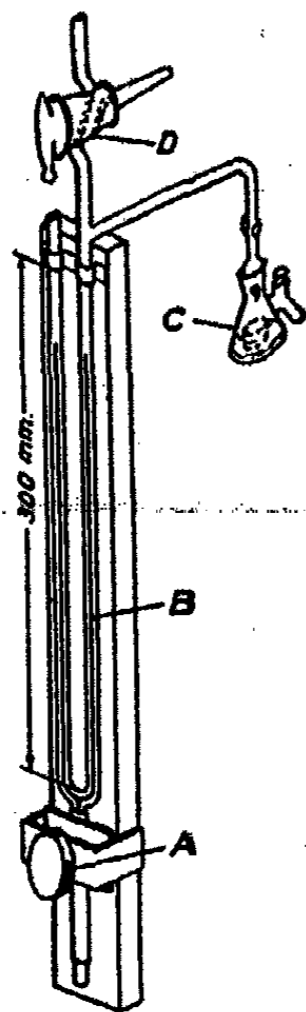

FIG. 1

Warburg-Barcroft manometer. A, Screw pinchcock. B, Manometer fluid in graduated capillary tube. C, Respiration vessel. D, Two-way stopcock. All glass-ware Pyrex.

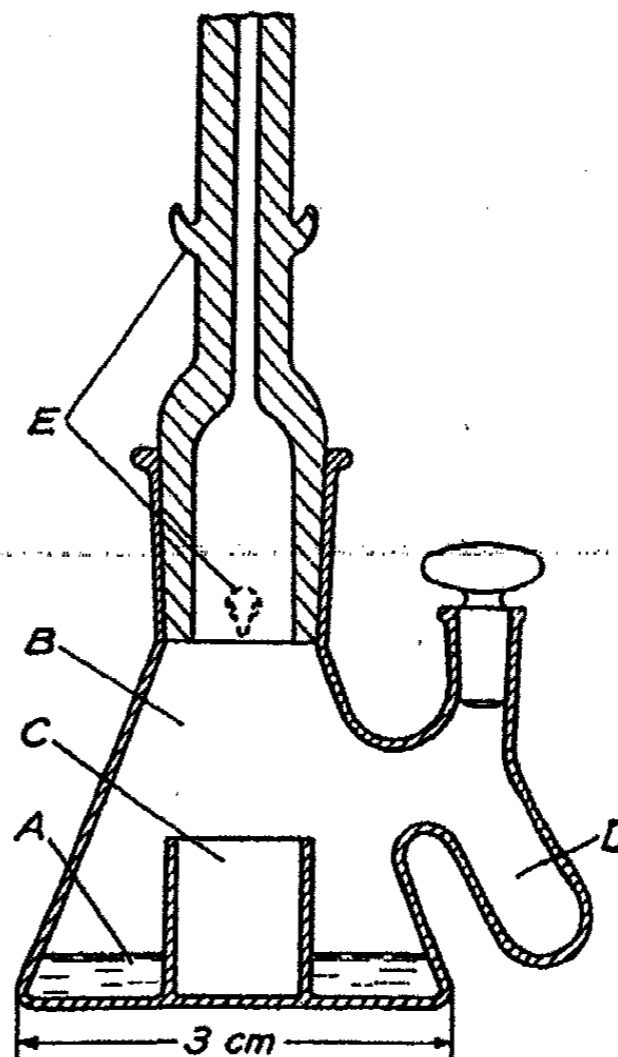

FIG. 2

Respiration Vessel. A, Culture medium (liquid phase). B, Gaseous phase, C, Container for CO<sub>2</sub>-absorbing strong alkali. D, Side-cup. E, Glass prongs for wire springs.

concentration, where the ratio of nitrogen fixed to oxygen consumed is slightly higher, a minor correction is sometimes necessary. No other gas is concerned in Azotobacter metabolism.

A given vessel is filled with a particular gaseous mixture by passing the latter for two or three minutes down through the manometer stopcock and out the glass-ground neck of the vessel's side-cup, at the rate of one to two liters a minute. At the same time the manometer fluid is raised once or twice to the height of the T-joint, in order to obviate the air which would otherwise contaminate the mixture, and the manometer itself is agitated to establish a quick equilibrium between gas and culture medium. Stopcock and side-cup are then closed simultaneously. The gaseous mixtures are made in a multiple all-glass flowmeter capable of mixing hydrogen, oxygen, nitrogen, or air, each individual flowmeter having been calibrated previously for a particular

gas with a standard Sargent wet gasmeter. The stock gases are contained in bombs, hydrogen (containing 0.0 to 0.5% nitrogen) having been prepared electrolytically, oxygen and nitrogen (usually containing less than 0.2% oxygen) from liquid air, and air by compression. When very low concentrations of oxygen in nitrogen are desired, bomb mixtures are made up separately some time before use, and are analyzed accurately for oxygen content in the Warburg apparatus, as explained below; the flowmeter is not employed.

Two species of *Azotobacter* have been used, *A. chroococcum*, Strain SM 1, obtained directly from the Rothamsted Experimental Station (England), and *A. vinelandii*, obtained originally from the New Jersey Agricultural Experiment Station. No quantitative or qualitative physiological differences between these two species have ever been detected by the writer, and hence the former has been used chiefly, inasmuch as all previous work was carried out with it.

Before occupying the manometer vessels, the experimental organisms are first grown at 28°C. for 24 to 48 hours in sterilized 250 cc. gas wash-bottles containing 50 cc. of culture medium of the following composition: 0.8 g.  $K_2HPO_4$ , 0.2 g.  $KH_2PO_4$  (pH 7.3); 0.2 g.  $MgSO_4$ ; 0.2 g. NaCl; 0.1 g.  $CaSO_4$ ; 0.01 g.  $Fe_2(SO_4)_3$ ; 1000 g. distilled  $H_2O$ . After being well shaken the medium is allowed to stand until clear. 20% distilled water and 1% glucose are added to the decanted solution before sterilization so that after the latter operation the medium is perfectly clear in spite of an approximately 10% loss of water therefrom. After inoculating from 24 to 48 hour growths, these stock cultures are then aerated with compressed air at the rate of 100 cc. per minute until ready for use in the Warburg apparatus.

The concentration of organisms desired in the manometer vessels depends upon the nature of the experiment. (1) For short time experiments of an hour or so, where respiration and not growth is concerned, relatively large concentrations are employed, 25 to 300 millions per cc. or more, consuming 25 to 300 cmm. of oxygen per hour. (2) For long time growth experiments lasting 12 to 16 hours, during which time the organisms may increase 15 to 30 fold, it is necessary to start with very small concentrations, 1 to 20 millions per cc., consuming 10 to 30 cmm. of oxygen per hour. Such small concentrations are obtained by diluting the 24 to 48 hour culture with the above inorganic medium and adding glucose (in the form of a 20% solution) as necessary. In practice, a culture is generally diluted one to two times its age in days, i.e., a 2 day culture is diluted two to four times its volume, but a preliminary experiment is always made to determine the exact requirement. In growth experiments where the total oxygen consumed exceeds the capacity of the manometer scale by several times, or in other experiments where it is desired to keep the oxygen pressure practically constant in spite of the oxygen consumption taking place, oxygen is added directly from a bomb (with the necessary assistance of a microregulator) thru the two-way stopcock. The manometer fluid is subsequently agitated several times all the way up and down the scale in order to mix the introduced oxygen thoroughly with the gas in the vessel.

Fourteen manometers are accommodated by the writer's Warburg apparatus thermostat, making a large number of simultaneous experiments possible. If it is desired to change the chemical environment of the organism (in distinction to the gaseous environment) by the addition of ammonia, potassium humate, etc., a 0.10 cc. portion of an aqueous solution of the chemical, made up to 20 times the desired concentration, is added to 2.00 cc. of the culture medium. At the same time, only 0.20 cc. of CO<sub>2</sub> absorbing alkali are used, in order to keep the total liquid volume in each vessel constant. The temperature of the thermostat is maintained at approximately  $28 \pm 0.01^\circ\text{C}$ . The gas pressure within the vessels is always atmospheric. The manometers are shaken at the rate of 120 cycles per minute with an amplitude of 3 centimeters, allowing maximum respiration.

The growth of bacteria is measured directly by counting the number of cells before and after an experiment by means of either Hawksley-Thoma or Petroff-Hausser haemocytometers, the depths of which are 20 instead of the usual 100 microns. Before counting, the pH is brought to 5 by adding to each vessel 0.10 cc. of H<sub>2</sub>SO<sub>4</sub> of the required strength; this prevents (1) all movement and (2) further growth, so that counting may be delayed several hours if necessary. The writer has found, indeed, that after bringing cultures under sterile conditions to pH 5.4, the count remains constant for at least four months (i.e., there is no autolysis), during which time no glucose is consumed. Respiration is, of course, completely inhibited below pH 5.8-6.0. Double organisms not yet divided are counted as two.

It will be well to point out the considerable advantages commanded by the above technique, now used with a nitrogen fixing organism for the first time. As will be considered in detail in a later paper, increases in rates of respiration result from increases in growth and nitrogen fixation. Since the manometers can be read very frequently, time curves of the increases of nitrogen fixation, growth, and respiration can be determined over very short periods of time (minutes and hours) with incomparably less labor as compared with the older Kjeldahl and sugar analysis methods, and with an accuracy considerably greater. Since the experiments occupy hours, rather than weeks, a great many more experiments in a given time are possible. In view of the young and highly diluted cultures used, one is concerned chiefly with constant, reproducible, and one might say, ideal conditions. The ambiguous effects occurring in the case of old or heavy growths, such as marked decreases in growth rate referable to mere numbers only, relative lack of nutrients, or complicated mixtures of various stages of life cycles, are avoided. One is concerned with the differentials and not merely the integrals of cell metabolism. Indeed, congruous comparisons may be made between the relatively ideal conditions obtaining in a study of bacteria, as above, and those obtaining in a study of solutions involving infinite dilutions. For practical purposes, the range of infinite dilution effects with Azotobacter occurs over a concentration of 0-200 millions per cc. In respect to the merits of the aforementioned technique, a complete and detailed study of all phases of the metabolism of Azo-

tobacter is being pushed rapidly forward in order to leave no fact undiscovered capable of throwing light on the mechanism of nitrogen fixation at ordinary temperatures and pressures.

## II. Gasometric Proof of Fixation

Reasonable proof of nitrogen fixation by living forms at ordinary temperatures and pressures has customarily been established by indirect means only, increases of fixed nitrogen in cultures (growing in either washed or unwashed air) having been measured chemically. Directly measured decreases of nitrogen gas have been described in but two of the thousands of papers devoted to biological fixation. Only one of these (Krzmienski,<sup>1</sup> 1908) was concerned with *Azotobacter*, the other with inoculated legumes and impure blue-green algae (Schloesing and Laurent,<sup>2</sup> 1892). The observations made in these investigations deserve every confidence. Our problem is by no means solved by this acknowledgment, however. Bonazzi<sup>3</sup> (1924) reports that repeated attempts made in his laboratory with *Azotobacter* failed to give the desired direct evidence.<sup>4</sup>

Almost the sole difficulty encountered in obtaining direct evidence lies in the fact that the nitrogen gas consumption involves only 1%, and usually less, of the total gas exchange, i.e., of the oxygen consumed simultaneously, and therefore its determination is nearly within the limits of experimental error of gas analysis. This difficulty has now been removed, since with very small concentrations of oxygen the ratio of nitrogen to oxygen consumed is increased to as much as 5 to 10% (Meyerhof and Burk, 1928).

The following experiment shows a consumption of gaseous nitrogen by *Azotobacter*. 0.4 cc. of 8 N NaOH was placed in each alkali container and 0.4 cc. of 25% pyrogallol acid in each side-cup. A 5 day culture of *A. vine-landii* diluted 10 times with inorganic medium and made up to 0.75% glucose, was used. Eight vessels were employed and to one half of these were added 0.10 mg. NH<sub>3</sub>-N (ammonia-nitrogen) per cc. of culture medium. This concentration was 20 times that necessary to prevent all fixation of

<sup>1</sup> Krzmienski: (1908) *Anz. Akad. Krakau*, 1908, 929.

<sup>2</sup> Schloesing and Laurent: *Ann. Inst. Pasteur*, 6, 65, 824 (1892).

<sup>3</sup> Bonazzi: 4th Inter. Soil Sc. Conf., Rome, Sect. III-B, No. 8 (1924).

<sup>4</sup> By way of indirect proof, the writer has grown *Azotobacter* at pH 7.1 in 3 liters of culture solution contained in 6 gas wash bottles and aerated for two weeks at the rate of 70 liters per day with an aspirator, the air being drawn from the incubator and passed through (1) 12 inches of cotton, (2) 4 inches of conc. H<sub>2</sub>SO<sub>4</sub>, (3) 4 inches of conc. KOH, (4) 4 inches of conc. H<sub>2</sub>SO<sub>4</sub>, and (5) 6 inches of sterile water. The large total amount of nitrogen fixed, as determined by the Kjeldahl method, was 72.2 mg., derived, presumably, from N<sub>2</sub> or N<sub>2</sub>O. Gas wash bottles containing definite quantities of N/20 H<sub>2</sub>SO<sub>4</sub> and N/20 NaOH and following the above train, showed that no fixed nitrogen gases (such as NH<sub>3</sub>) were given off by the growing cultures, there being no change in the titration values, nor any appearance of these gases as determined by four qualitative tests (mentioned later) sensitive to one part in ten million. In the same incubator containing the above cultures, were placed unaerated, unshaken, Erlenmeyer flasks filled with the usual 1% glucose medium, and inoculated with spores of *Aspergillus niger*. No visible growth or nitrogen fixation (as shown by the Kjeldahl method) took place over a period of two months. The addition of as little as .2 mg. of fixed nitrogen as ammonium nitrate per 100 cc. immediately initiated growth, the latter being visible in 12 hours. This was taken to show that regardless of any fixed nitrogen compound which might have occurred in the air, none was ever absorbed by the culture solutions.

nitrogen (see later paper). All vessels were filled with a bomb mixture of nitrogen containing 2.1% oxygen, washed through sulfuric acid, permanganate, alkali, sulphuric acid and distilled water, then the organizations therein allowed to grow for 14 hours, by the end of which time 97 to 100% of the total oxygen was consumed in all vessels, as shown by the fact that upon tipping the pyrogallol acid and alkali in with the culture the readings increased only 3 to 6% in the various manometers. Cultures of *Azotobacter* are able to remove the last trace of oxygen from a gas; at least so far as alkaline pyrogallol is likewise able.

The following manometer readings in millimeters were obtained in the case of the organisms fed ammonia (i.e., those using oxygen only): -232, -232, -230, -230; average -231. The following readings were obtained in the case of the organisms not fed ammonia (i.e., those using oxygen and, as the figures show, nitrogen also); -239, -249, -236, -239; average -240.8. The ratio of nitrogen decrease to oxygen decrease is therefore  $-9.8/-231$ , or 4.2%, which agrees well with efficiencies observed by the indirect method using Kjeldahl analyses (Meyerhof and Burk, 1928, p. 139) for the same average oxygen content range. The average manometer readings of 9.8 and 231 corresponded to 12.0 cmm. of nitrogen and 282 cmm. of oxygen, respectively.

Similar results were obtained with *A. chroococcum*, Strain SM 1, and also when the ammonia-nitrogen was replaced by the same concentration of nitrate-nitrogen. It should be pointed out that in control vessels without organisms no absorption of oxygen by the slightly acid pyrogallol acid in the side-cup took place, the reading remaining 0 for at least 24 hours. Then when the pyrogallol acid was mixed with the alkali, complete absorption of oxygen, corresponding to 231 scale readings, took place in 3 minutes with 8 N NaOH, and only slightly longer with 2 N NaOH. This extremely accurate method of analyzing for percentages of oxygen between 0.1 and 3.0% has been well worked out by the writer.

Under the conditions of the above experiments, with washed gases, and with liquid and strongly alkaline water phases present in the vessels, the only gaseous nitrogen-oxygen or nitrogen-hydrogen compound stable at ordinary temperatures which could exist in the gas phase, and therefore by consumption be mistaken for nitrogen fixation, was  $N_2O$ . Maassen and Schoenewald<sup>1</sup> (1910) have shown, however, that *Azotobacter* (as well as *Rhizobium* and eight other organisms) is incapable of utilizing this gas.

### III. The Effective Biological Nitrogen Pressure Range

#### A. *Azotobacter*

The solution of a large number of collateral relations is shown in Fig. 3. Six vessels were seeded with a 48 hr. culture of *A. vinelandii*, containing 30 million bacteria per cc., without further addition of glucose or dilution with inorganic medium. The oxygen content of all vessels was maintained at 21% throughout the entire experiment. Two vessels were started with 21%  $O_2$

<sup>1</sup> Maassen and Schoenewald: Kais. Biol. Anst. Land. Forstw. 1910, 32.

in  $N_2$  (Curves I and II), two with 21%  $O_2$  in  $H_2$  (Curves III and IV), and two were given 0.10 mg.  $NH_3-N$  per cc. and grown in 21%  $O_2$  in respectively  $N_2$  (Curve V) and  $H_2$  (Curve VI). Later additions of 1 and 6%  $N_2$  (Curves III, c, and IV d, respectively) were made by drawing air in through the stopcocks. Replacement of  $N_2$  with  $H_2$  (Curve II, a), and later addition of 20%  $N_2$  (Curve II, b) required temporary removals of the manometer from the thermostat and complete refillings of the vessel.

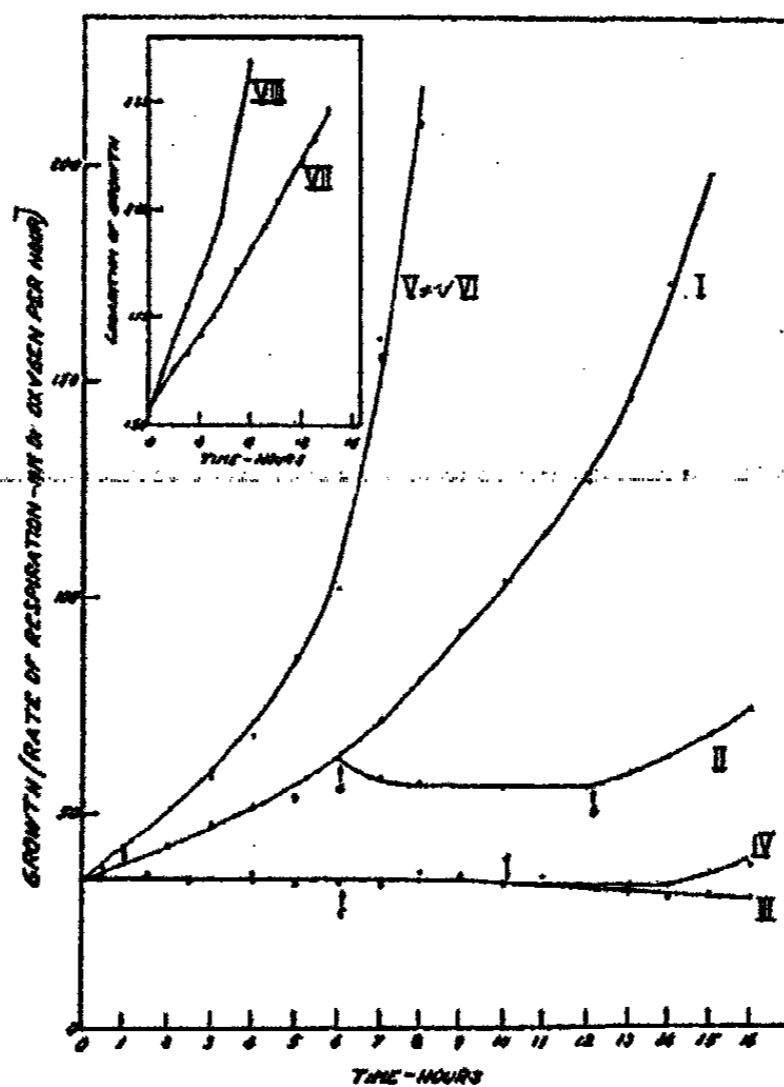

FIG. 3

Time Course of Growth in Free and Fixed Nitrogen as measured by Respiration Rate Increase.

I, 21%  $O_2$  in  $N_2$  (normal growth in air). II, Initially 21%  $O_2$  in  $N_2$ , changed at 6 hrs. (a) to 21%  $O_2$  in  $H_2$  (growth stopped immediately), changed at 12 hrs. (b) to 20%  $N_2$  in 21%  $O_2$  and  $H_2$  (growth recommences immediately). III, Initially 21%  $O_2$  in  $H_2$  (no growth in 6 hrs.), changed at 6 hrs. (c) to 1%  $N_2$  in 21%  $O_2$  and  $H_2$  (no growth after 10 more hours). IV, initially 21%  $O_2$  in  $H_2$  (no growth in 10 hrs.), changed at 10 hrs. (d) to 6%  $N_2$  in 21%  $O_2$  and  $H_2$  (growth evident after 3 to 4 hrs.). V(x) and VI(.), .10 mg. fixed nitrogen as ammonia per cc. of culture medium (to prevent fixation), gases respectively 21%  $O_2$  in  $N_2$  and 21%  $O_2$  in  $H_2$  (growth rates identical, but greater than in case of free nitrogen, I). VII and VIII, logarithmic replots of I and V (or VI) showing logarithmic nature of growth.

Curves I and VII show the typical, upwardly concave, logarithmic nature of the increase of rate of respiration, or growth, in air, with respect to time. That growth in this case is conditioned by nitrogen fixation, is shown in Curve II, where growth ceases immediately upon replacement of the nitrogen (at a), and does not continue until nitrogen is readmitted (as at b). Readmission of 20% nitrogen permits a growth rate approximately one half that at 78%  $N_2$ , as indicated by the relative slopes of the logarithms of Curve II, 12 to 16 hrs., and Curve I. The sharp immediacy of both cessation and continuance of growth in Curve II, as dependent upon, respectively, absence and presence



of nitrogen gas, is to be observed. Although readings were made every hour only, the subsequent slopes of the parts of the curves after *a* and *b* indicate that the effects of absence and presence of nitrogen occur within a few minutes and possibly less. The slight fall in slope at *a* is not understood entirely; it does not usually take place in other experiments of a similar nature.

Curve III shows that in the absence of nitrogen the rate of respiration is constant and that even the addition of 1% N<sub>2</sub>, also, causes no rise. A count of 14 hrs. showed that no growth had occurred, confirming the interpretation of constant respiration rate. The very slight fall noticeable after 12 to 16 hours is owing, no doubt, to a decline in the activity of the organisms, especially a decline in the QO<sub>2</sub> value with age as noted by Meyerhof and Burk (1928).

Curve IV shows that even with 6% N<sub>2</sub>, added after 10 hrs. of a constantly maintained rate of respiration, fixation-growth is noticeable only after three to four hours, proceeding at a very slow rate. It is rather a surprising fact that *Azotobacter* is not able to use the last traces of nitrogen, considering that, as a general rule in Nature, if an organism is affected at all by a gas it is affected by very low concentrations. The fact that 0.2% N<sub>2</sub> in the gas would supply sufficient nitrogen for a fairly heavy growth (2 mg. of bacterial-N per 100 cc.) shows how significant the concentration factor is, as distinguished from the total amount, since fixation can hardly be said to take place until about 5% N<sub>2</sub> is attained.

Curves V (x) and VI (.), being identical, show that at a concentration of 0.10 mg. NH<sub>3</sub>-N per cc. the growth is governed entirely by the fixed nitrogen supply, and that nitrogen gas is, under this condition, entirely inert. This proves that the foregoing observed effect of varying nitrogen pressures on growth is to influence directly the chemical process of nitrogen fixation *per se*, and not growth-metabolism in general, since growth can proceed normally in the absence of free nitrogen.

The logarithmic nature of growth in ammonia, as well as in free nitrogen, is shown in Curve VIII. Although both Curves VII and VIII, which are based on the smoothed respiration rate curves, show a slight, and presumably sudden, increase of slope at five and one half hours, many other experiments show that this is not the normal behavior. The effect is slight, and, in any case, since the breaks occur at the same time in both fixed and free nitrogen, their cause is hardly to be referred to the effect of either of these kinds of nitrogen in particular.

In making quantitative rather than qualitative comparisons of the relative growth rates as plotted in Fig. 3, *k*, in the equation, growth = *k* respiration rate increase, is, in fact, to some degree a function of the slope of the curve, being greater the greater the slope at any given oxygen pressure. This is true since, as will be shown later, the efficiency of growth increases with the rate of growth. The relative differences between the growths are therefore greater than the increases in respiration rate would make them appear.

It is to be observed that the initial rates of respiration are independent of the presence of H<sub>2</sub>, N<sub>2</sub>, or NH<sub>3</sub>-N, and depend solely upon the oxygen tension.

This is always the case in young cultures, although in the case of old undiluted cultures (seven days old or more) the respiration rate is inhibited somewhat by  $\text{NH}_3\text{-N}$ .

The accuracy and duplication obtainable with the Warburg apparatus in respiration and growth experiments is well indicated by Curves I and II, 0-6 hrs.; Curves III and IV, 0-10 hrs.; and Curves V and VI, 0-8 hrs.

#### B. Pressures of Nitrogen greater than Atmospheric

Although the curves of Fig. 3 show clearly the effect of growing Azotobacter in low nitrogen pressures, they give no indication of the effect of pressures greater than 0.8 atmosphere. The following experiment shows that growth is distinctly increased at such superior pressures. Erlenmeyer flasks containing 25 cc. each of culture medium were inoculated from a young culture of *A. chroococcum*, one half the flasks being placed inside a bomb containing air, the other half being placed outside, all in an air thermostat at 25°C. The total pressure in the bomb was raised with nitrogen to 6 atmospheres.

Nephelometric turbidity measurements made after thirty-six hours showed that the eight-fold increase in nitrogen pressure had caused a two-fold increase in growth.\* The cultures were not shaken, but this can have made no difference in the final conclusion since the equilibrium concentrations of  $\text{N}_2$  would have been quickly attained at either of the pressures, and continually maintained owing to the relatively very slow utilization of  $\text{N}_2$ .

#### C. Legume Bacteria

We see how quickly, delicately, and simply, questioned nitrogen fixing abilities of organisms in general may be determined, by observing their rates of respiration in respectively  $\text{H}_2$ ,  $\text{N}_2$ , and  $\text{NH}_3$ , after the manner outlined by the writer above. This is particularly true in cases in which it is desired to demonstrate fixation in nitrogen-rich soils, slight increases in fixation observed chemically being very difficult to prove significant, owing to the inaccuracy of the Kjeldahl method where nitrogen-rich soils are concerned. The writer has used the method to determine whether legume bacteria fix nitrogen in the absence of a host plant. The question is highly important, since Allison<sup>1</sup> (1929), upon the basis of several years experiments and a critique of all pertinent work of previous investigators, has thrown strong doubt upon the probability, at least so far as ordinary conditions of culture are concerned. The following experiment of the writer with pea legume organism Strain 302 (Fred), given in Fig. 4 and Table I, not only confirm the conclusion of Allison, but show also that fixation is not influenced by the presence of hydrogen gas, nor by varying the pressures of the gases,  $\text{N}_2$ ,  $\text{O}_2$ , and  $\text{H}_2$  100-fold, factors which have not been tested by other workers previously. Before

\* In view of the fact that, as the writer has found, the growth rate passes through a maximum with respect to fixed nitrogen concentration, it is quite possible that at still higher pressures of nitrogen gas the growth rate would decline.

<sup>1</sup> Allison: J. Agr. Res., 39, 893 (1929); see also Hopkins: Soil Science, 28, 433 (1929); also Löhnis: Soil Science, 29, 35 (1930).

occupying the Warburg vessels the organisms were grown in 1% glucose-inorganic medium that contained initially 0.02 mg.  $\text{NH}_3\text{-N}$  per cc., but this fixed nitrogen was consumed before occupation, as shown chemically by qualitative Nessler and quantitative distillation tests, and physiologically by Curves I, II, III, Fig. 4.

In Fig. 4, we see that in the presence of free nitrogen there is no growth or fixation of nitrogen, at least over the pH range (adjusted with  $\text{N}/100 \text{H}_2\text{SO}_4$  and  $\text{N}/100 \text{NaOH}$ ) 4.8 to 8.0. The initial rate of respiration is constant over

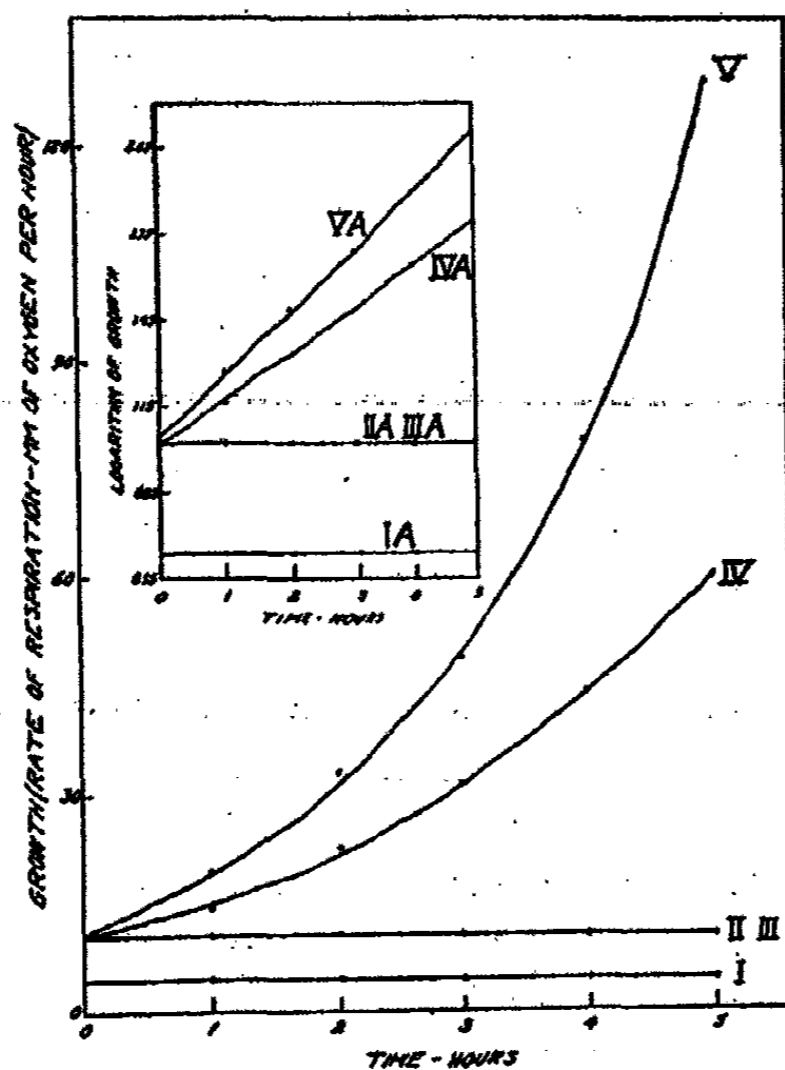

FIG. 4

Time Course of Growth of Rhizobium in Free and Fixed Nitrogen as measured by Respiration Rate Increase, in Air.

2 day culture of pea legume organism Strain 302 (Fred). Curves I, II, III, growth in free nitrogen at pH 8.0, 7.1, and 4.8, respectively (no growth). Curves IV and V, growth at pH 7.1 in media containing respectively .05 mg.  $\text{NO}_3\text{-N}$  per cc. and .1 mg.  $\text{NH}_3\text{-N}$  per cc. Curves IA, IIA, IIIA, IVA, and VA are logarithmic replots of Curves I, II, III, IV, and V, respectively.

the pH range 4.8 to 7.1, but falls off on the alkaline side. There is, on the other hand, a very rapid growth in the presence of fixed nitrogen, more in ammonia than in nitrate,<sup>2</sup> and commencing immediately, as the interpolated curves between 0 and 1 hours show. The growth of Rhizobium in ammonia, as judged by respiration rate (and confirmed approximately by turbidity measurements), is much greater than that of Azotobacter in ammonia, the generation times (i. e., the number of hours required to double the respiration

<sup>2</sup> This observation holds generally, and does not depend upon the slightly different concentrations used in this particular experiment. In other experiments with exactly equal concentrations, the growth differences between cases of  $\text{NH}_3\text{-N}$  and  $\text{NO}_3\text{-N}$  nutrition have even been greater, in fact.

rate) being  $1\frac{1}{2}$  and  $3\frac{1}{2}$  hours, respectively. The delicacy of the test of non-fixation by *Rhizobium* in free nitrogen is therefore even greater than in the case of *Azotobacter* in 0 to 5% free nitrogen. Curves IV A and V A show the logarithmic nature of growth by *Rhizobium* in fixed nitrogen. It is to be observed that the initial rate of respiration of *Rhizobium* at 0 hrs. is the same in the presence or absence of fixed nitrogen, at the same pH.

Table I gives the amounts of oxygen consumed by the identical culture of pea legume bacteria used for the results of Fig. 4, one day older, however, in the important combinations of nitrogen, oxygen, and hydrogen between 0 and 100%. The conclusion may be safely drawn that both respiration and nitrogen fixation by *Rhizobium* in a nitrogen free medium are independent of the oxygen pressure between 100 and 0.25% (or even less) atmosphere of oxygen, and totally independent of nitrogen and hydrogen pressures between 100 and 0%.<sup>1</sup> Not only does the actual experimental error, amounting to about  $\pm 6\%$ , lie within the limits of the method where so many manometers are run simultaneously without duplicates, but still more important, the variations are quite random and can not consistently be assigned to the effect of any one gas. The variations become smaller with time. Moreover, the same relative, slight fall in rate occurs in all cultures. The gas relations of *Azotobacter* and *Rhizobium* are obviously entirely dissimilar, so far as nitrogen and oxygen are concerned; hydrogen is inert in both cases.

#### IV. Respiration, Growth, and Efficiency of Growth as Functions of Nitrogen Pressure

Data for three experiments A, B, and B' will be given.

In Experiment A, a 3 day culture of *A. chroococcum* Strain SM 1 (diluted four times with inorganic medium and made up with 0.5% glucose, so as to contain 20 million bacteria per 2 cc. giving an initial respiration of 20 to 21 cmm. of oxygen per hr.) was grown for 11 hrs. in 10% O<sub>2</sub> in the following percentages of nitrogen: 0, 0, 2, 4, 6, 10, 15, 20, 30, 50, 70, 90; hydrogen being the complementary gas. No final counts were made.

In Experiment B-B', a 36 hour culture of Strain SM 1 (diluted three times with inorganic medium and made up with 0.25% glucose, so as to contain 24 million bacteria per 2 cc. giving in B and B' respectively 23 and 25 cmm. of oxygen per hour) was grown for 13 hrs. in 20% oxygen in the following percentages of nitrogen: 0, 3, 10, 25, 45, 78; hydrogen being the complementary gas. Experiment B' differed from Experiment B in that 0.25 mg. of humic acid as potassium humate, was added to each 2 cc. of culture medium. The humic acid had been prepared from a garden soil by washing with 5 N HCl,

<sup>1</sup> The writer has also found that in pure hydrogen or nitrogen (i.e., in the absence of oxygen) the legume organism produces no CO<sub>2</sub> (i.e., less than 0.5% by volume of its oxygen consumption had it been maintained in air), even after five hours. Nevertheless, anaerobic metabolism and, in the presence of fixed nitrogen, growth, occur to a certain extent during this period of time, since, upon readmission of oxygen, approximately the original rate of respiration in air is immediately reestablished, and, in the case of those organisms maintained in fixed nitrogen during the anaerobiosis, the respiration is actually greater than the original rate. Such metabolism and growth during anaerobiosis are, of course, small, and moreover, no nitrogen fixation takes place. The respiratory quotient in air is approximately 1.

leaching in the cold for 12 hrs. with 10% KOH, clarifying by centrifugation, precipitating with 5 N HCl, reclarifying by centrifugation, and rewashing similarly four times in all. The final precipitate of humic acid was cautiously dissolved with 10% KOH, giving a solution at pH 8 that contained 10 mg. of humic acid per cc. (as determined by reprecipitating a given volume in weighed centrifuge cups, and reweighing the cups after centrifugation, decantation and drying over  $H_2SO_4$  *in vacuo*), and 0.43 mg. of nitrogen per cc. The humic acid therefore contained 4.3% nitrogen. Azotobacter is utterly unable to use this nitrogen, however, as shown (1), by the fact that organisms fed humic acid (corresponding to approximately 0.01 mg. N per cc. of culture medium, ample for a vigorous growth) make no growth in oxygen-hydrogen mixtures free of nitrogen gas (Experiment B', and other similar ones), and (2), by Krzmeiniewsky (1908) using an entirely different technique. Counts were made in Experiment B-B'. Distinction with respect to age was made between two classes of organisms found to occur in extremely young cultures—those about 1 to 2 $\mu$  in diameter and those about 0.5 $\mu$ . The distribution of the initial 24 millions of bacteria per cc. in Experiment B-B' was 14 large to 10 small, or a ratio of 1.4.

#### A. Growth and Growth Respiration

Fig. 5 shows the straight line increase of growth (increase of increase of cell numbers) with nitrogen pressure between about 3 to 5% and 50 to 60%  $N_2$ , in the presence and absence of humic acid (Experiment B-B'). As is seen, within this range the same qualitative growth results are obtained whether total, large, or small organisms are used, so that results with the total number only will be considered hereafter, inasmuch as they are the most accurate. In a given experiment, practically the same ratio of large to small organisms obtains, being at 25, 45, and 78%  $N_2$ , respectively, 1.60, 1.47, and 1.55 in Experiment B, and 1.12, 1.20, and 1.22 in Experiment B'. In general, the more rapid the rate of growth (i.e., the smaller the generation time), or the older the inoculation, the smaller will the ratio be. Organisms growing in ammonia often show a still smaller ratio.

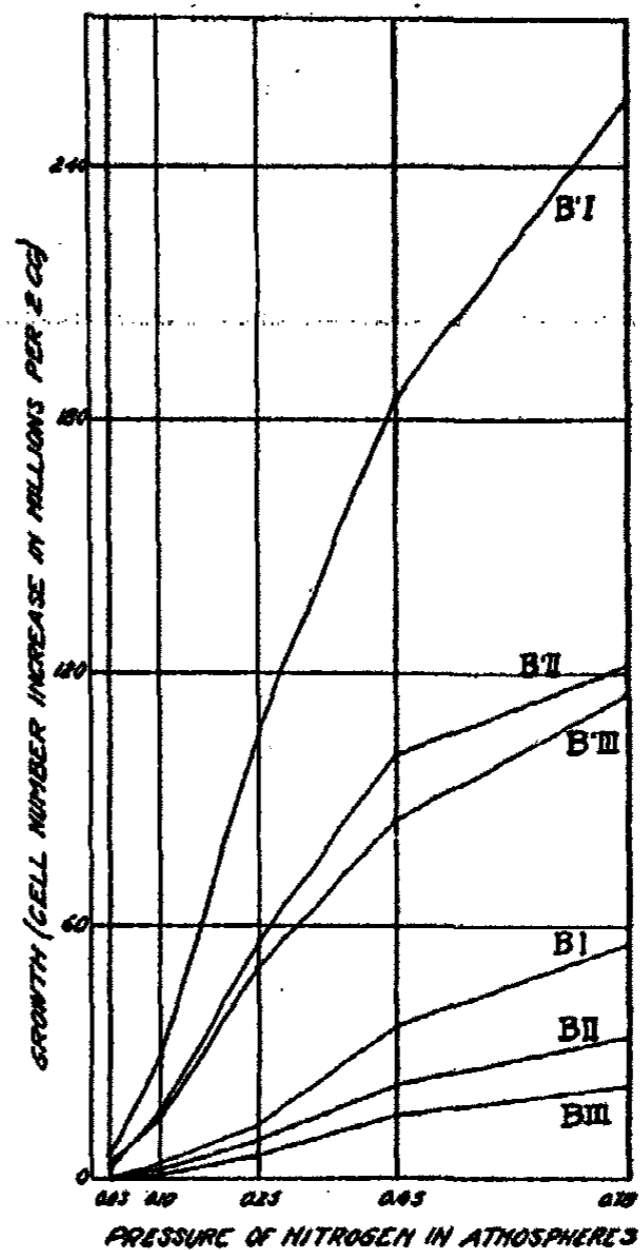

FIG. 5  
Influence of Nitrogen Pressure upon Growth.

B-I, II, III, respectively total, large, and small organism cell number increases, in the absence of humic acid. B'-I, II, III, respectively total, large, and small organism cell number increases, in the presence of humic acid.

Fig. 6 shows the same straight line increase of both growth respiration and respiration rate increase with nitrogen pressure, as found above with growth, occurring between 4 and 5% and 50 to 60% in the absence of humic acid, and between 2 to 3% and 50 to 60% in the presence of humic acid. Growth respiration is the increased respiration due to growth, and is defined as the total respiration less the resting respiration occurring in controls where no growth takes place, i.e., in the cases of (1) fixing organisms without free or fixed nitrogen, and (2) non-fixing organisms without fixed nitrogen. The resting respirations in A, B, and B' were 225, 290, and 309 cmm. respectively.

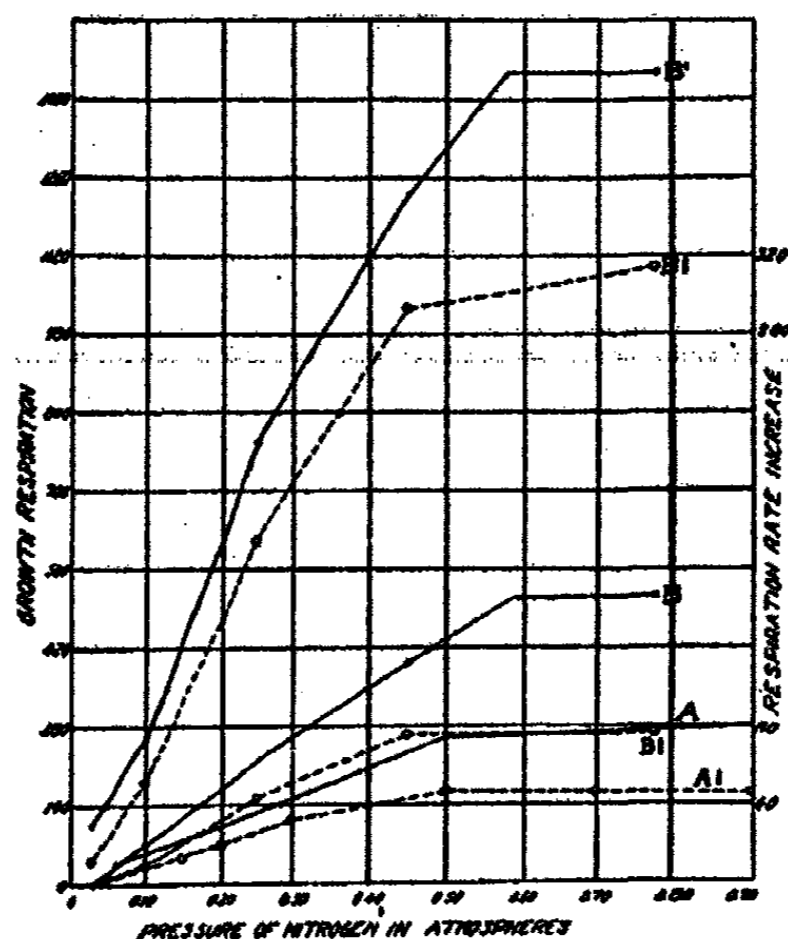

FIG. 6

Influence of Nitrogen Pressure upon Growth Respiration and Respiration Rate Increase. A, Experiment A, 10% O<sub>2</sub>, 11 hrs. duration. B and B', Experiments B-B', 20% O<sub>2</sub>, with and without humic acid, respectively. Solid lines, growth respiration; dotted lines, respiration rate increase.

In order to show conclusively that a relationship found to occur between growth and some other factor, in this instance nitrogen pressure, is independent of time, the data must consist of more than initial and final measurements, i.e., more than those as given in Figs. 5 and 6. One must be certain that the equation expressing the reaction (in this instance, a logarithmic, monomolecular one) is well obeyed over the entire time course. The necessity for this precaution has been well illustrated by Werkman (1927,<sup>1</sup> who showed by analyses of time courses of growths by *Azotobacter* with and without vitamine B concentrate that the increases of growth caused by the latter were not owing to stimulation of the growth rate by vitamine B itself, but to an initial acceleration incurred by traces of fixed nitrogen in the concentrate. After the initial acceleration, which lasted only a few hours, during which

<sup>1</sup> Werkman: *J. Bact.*, 14, 335 (1927).

TABLE I  
The Effect of Different Mixtures of Nitrogen, Hydrogen, and Oxygen on Respiration,  
Growth, and Nitrogen Fixation by Rhizobium

Mixture No.	1	2	3	4	5	6	7	8	9	10	11	12	13
% O <sub>2</sub>	21	21	21	100	99	90	60	5	.25	1	5	5	1
% N <sub>2</sub>	79	10	1	0	1	10	40	95	99.75	99	5	1	1
% H <sub>2</sub>	0	69	78	0	0	0	0	0	0	0	90	94	98
Cmm. O <sub>2</sub> consumed													
0-2 hrs.	25.2	25.8	23.1	22.0	21.8	24.3	25.0	23.9	20.8	22.1	19.5	19.8	22.0
2-5 hrs.	35.0	33.5	32.2	34.4	31.5	33.6	28.8	30.2	9.2	29.6	30.9	29.8	29.8
5-9 hrs.	41.8	37.4	39.5	38.6	33.9	39.1	36.2	34.1	0.0	34.3	37.0	36.9	34.4
0-9 hrs.	101	96.7	94.8	95.0	87.2	97.0	90.0	88.2	30.0*	86.0	87.4	86.5	86.2

\* Total oxygen available.

time, however, the number of organisms in the treated cultures had greatly increased relatively, the logarithms of the subsequent amounts of growths plotted against time showed parallel slopes, indicating equal generation times, or the same constant of geometric increase. The distinction between amounts of growth and rates of growth must therefore always be clearly differentiated.

Fig. 7 shows that a sufficiently logarithmic time curve with respect to respiration rate is observed at each pressure of nitrogen. We may safely conclude, therefore, that growth and nitrogen fixation are as a first approximation, directly proportional to the pressure of nitrogen up to 0.5 atmosphere.

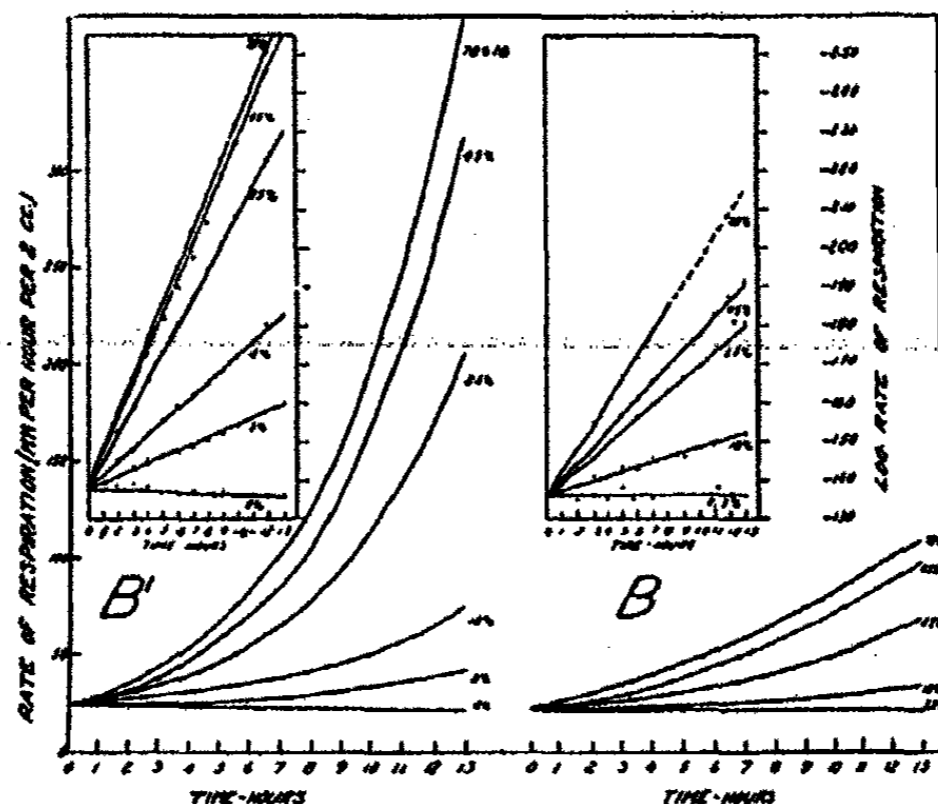

FIG. 7

Influence of Various Pressures of Nitrogen upon Rate of Respiration.  
Section B, Experiment B, without humic acid.  
Section B', Experiment B', with humic acid.

It is perhaps necessary to point out that since Strain SM 1 does not produce and give off available fixed nitrogen compounds into the surrounding medium, growth under conditions maintained by the writer parallels nitrogen fixation, being limited by it. This parallel relationship was shown experimentally by Meyerhof and Burk (1928). The non-production of soluble nitrogen compounds was shown by the writer as follows. (1) Liquid portions of centrifuged cultures were found to contain no nitrogen, by the Kjeldahl method. (2) Alkaline distillations of 10 cc. portions of more than 200 Erlenmeyer flask cultures, grown over a great variety of conditions and ages (up to four months) yielded no trace of ammonia, amines, or other volatile nitrogen bases (less than 0.01 cc. N/100 N, or .0014 mg. of N). (3) Four strains of *Aspergillus niger* molds made no growth when inoculated into cultures of several strains of *Azotobacter chroococcum* regardless of the latter's ages (i.e., up to four months), whereas if traces of fixed nitrogen were given these same mold-inoculated cultures, growth was prominent in less than 24 hours. *Azotobacter chroococcum* cultures of any age, made alkaline with potassium carbonate, could be distilled in steam in a Pregl-microkjeldahl apparatus for



at least half an hour and doubtless longer without yielding volatile bases. (4) More than 200 cultures (as above) were tested by the usual and most sensitive oxygen-nitrogen and oxygen-hydrogen test reagents (Diphenylamine, Griess, Trommsdorff, and Nessler) with entirely negative results. The tests were sensitive to one part in ten million, and the addition of one part in ten million of  $\text{NO}_3^-$ ,  $\text{NO}_2^-$ , or  $\text{NH}_4^+$  to a tested negative fluid resulted in a positive test.

That (1) nitrogen is fixed as a function of nitrogen pressure between 0.05 and 5 to 10 atmospheres, and (2) the rate<sup>1</sup> is almost directly proportional to the pressure within the range 0.05 to 0.5 atmosphere, and possibly higher, must be considered as the only two facts known concerning the chemical, as distinguished from the physiological, mechanism of nitrogen fixation by *Azotobacter* at ordinary temperatures and pressures at 0.2 atmosphere of oxygen. Although the physiological behavior of *Azotobacter* is often unique (particularly with respect to oxygen pressure and pH), such behavior is the same whether the nitrogen supply of the organism is either free or fixed (Burk and Lineweaver: Jour. Bact., in Press). The fixation-pressure promises to be similar to that given by the Langmuir equation for the amount of gas adsorbed in a monomolecular layer at catalytic surfaces with different gas pressures. Further experiments are being performed to decide this point.

#### B. The Influence of Humic Acid

We see that humic acid causes increases in growth and growth respiration at all pressures of nitrogen, and does so *immediately*. Moreover, the increases are roughly constant for all pressures above 10%, as shown by the straightness or otherwise proportionally parallel nature of the respective lines. The constants are about 6 for growth and about 3 for growth respiration. Since the humic acid effect is therefore independent of the pressure of nitrogen, except possibly at very low pressures, and since, as shown above, the pressure of nitrogen affects nitrogen fixation, as distinguished from growth, directly, one must infer that the humic acid exerts its direct effect upon growth and *not* upon nitrogen fixation. This view is confirmed by the finding that humic acid not only exerts an equally great effect upon organisms growing in fixed nitrogen, but, still more important, it likewise stimulates growth rates of organisms growing in limiting concentrations of ammonia nitrogen in 20%  $\text{O}_2$  in  $\text{H}_2$ . In other words, although growth may be limited by nitrogen supply, fixed or free, humic acid may still exert its stimulation of growth with consequent greater consumption of that supply. Moreover, the growth rates of legume bacteria growing in ammonia in either the absence or presence of nitrogen gas are increased just as in the case of *Azotobacter*, qualitatively and quantitatively, as the writer has found with both the Warburg technique, and the

<sup>1</sup> The true expression for the rate of growth,  $r$ , as a function of final count,  $f$ , is, of course, from the formula for geometric progression,  $r = \text{antilog} ((\log f - \log i)/t)$ , where  $i$  is the initial count and  $t$  is the time. On the basis of numerous experiments involving pressures both below and above 0.8 atmosphere of nitrogen in addition to those reported, the employment of this formula, rather than the one actually used,  $r \propto (f - i)$ , leads to no appreciable alteration of the view that up to at least 0.5 atmosphere of nitrogen the rate of growth as well as the growth is approximately proportional to the pressure of nitrogen.

ordinary Erlenmeyer culture technique lasting for several days. For these four reasons, we must conclude that humic acid does not affect directly the chemical process or mechanism of nitrogen fixation.

That the limiting low pressure of nitrogen (i.e., .05 atmosphere) is lowered by the presence of humic acid can be explained as an indirect effect. Since the growth rate in limiting amounts of nitrogen (whether fixed or free) is increased, growth is observed sooner. In other words, the observation that in the absence of humic acid growth does not commence until about 5%, is somewhat conditioned by the element of time, and if Experiment A or B had lasted several days (or weeks), it is probable that nitrogen pressures below 5% would have been found effective also. Consumption of nitrogen may presumably take place at any pressure however small, at a rate however small, but at 21% O<sub>2</sub> is appreciable experimentally within a reasonable time at only relatively high pressures such as 3 to 5%.

It will be noticed in Experiment B' that growth respiration at 3% N<sub>2</sub> (Fig. 6) detects growth more delicately than count increase (Fig. 5). This is as it should be, since the efficiency is so extremely low. It should also be observed that humic acid does not affect the initial respiration, only the growth respiration. This has been confirmed in many experiments. The effect of humic acid is in all probability to be referred chiefly to increased mitotic cell division. There is much reason to believe with Allen (1919) that humic acid greatly increases phosphate availability, which would increase cell division.

### C. The Influence of Low Oxygen Pressures

The influence of low oxygen pressures and humic acid upon fixation at low nitrogen pressures is shown in the experiments (lasting 13 hours) reported in Table II. It might be supposed that since normal growth in air is inhibited as compared with concentrations of oxygen down to 0.05 atmosphere, the limiting low nitrogen pressure would possibly be lowered by low oxygen concentrations. We see from Table II that in the absence of humic acid no measurable growth has taken place at 1% N<sub>2</sub> with either 21, 5, or 1% O<sub>2</sub>. Moreover, when humic acid is present and causes growth at  $\frac{1}{2}$  or 1% N<sub>2</sub>, there is actually less growth at 1% O<sub>2</sub> than at 21% O<sub>2</sub>. As a matter of fact, however, employing nephelometry as a more delicate means of detecting small amounts of growth, it can be shown that at 5% O<sub>2</sub>, where growth is perhaps five times as rapid as at 21% O<sub>2</sub>, fixation takes place even at 1% N<sub>2</sub>; and that the linear fixation-pressure function passes through the origin. In one particular experiment lasting twelve hours, the following percentage increases of growth (relative to the initial inoculum), 0, 10, 21, 28, 35, 35, 44, 64, and 187 were obtained at the respective nitrogen pressures, 0, 1.5, 4, 5, 6, 7, 8, 10, and 30 per cent atmospheres; the plot yields a straight line between 0 and 30 per cent atmospheres. As stated just above, therefore, measurement of fixation at low nitrogen pressures is conditioned by the element of time, as well as means of measurement, and the observed effects of humic acid and optimum oxygen concentration are to be ascribed to the same cause, namely, the cir-

**TABLE II**

**The Influence of Humic Acid and Low Oxygen Pressure upon Fixation at Low Nitrogen Pressures**

	Gas (H <sub>2</sub> to 100%)		21% O <sub>2</sub> , 1% N <sub>2</sub>		5% O <sub>2</sub> , 1% N <sub>2</sub>		1% O <sub>2</sub> , 1% N <sub>2</sub>		1% O <sub>2</sub> , 99% N <sub>2</sub>	
<i>.125 mg. Humic Acid per ½ cc. medium</i>										
<i>Count Increase.</i>										
<i>Culture No. 1 (Strain SM 1) 1 day</i>										
old, undiluted										
Initial Count, 24 mill./cc.	0	16	0	0	0	6	46	102	X	X
<i>Count Increase</i>										
<i>Culture No. 2 (Strain SM 1) 2 days</i>										
old, diluted 4 times										
Glucose added to .5%										
Initial Count, 24 mill./cc.	0	32	0	0	8	43	94			
<i>Efficiency Culture No. 1 (Count Increase/Total Respiration)</i>										
	0	.043	0	0	.028	.17	.32			
<i>Efficiency Culture No. 2</i>										
	0	.083	0	0	.04	.16	.40			

RECEIVED AT THE NATIONAL BUREAU OF STANDARDS, U.S. DEPARTMENT OF COMMERCE, WASHINGTON, D.C., JANUARY 10, 1934.

cumstance of increased growth rate. The results with 1%  $O_2$  in 99%  $N_2$  in Table II are given to show that humic acid still influences growth in normal pressures of nitrogen even at 1%  $O_2$ . In both experiments (Cultures 1 and 2) with 1%  $O_2$  in 99%  $N_2$ , the growth is doubled, as compared with a six-fold increase in 21%  $O_2$  in Experiment B-B', Fig. 5.

#### D. Efficiency

The increase of efficiency of growth with nitrogen pressure, non-linear as shown in Fig. 8, presents, perhaps, the most interesting relationship of all. Although both increasing pressures of nitrogen and humic acid increase the efficiency of growth, the plot on the right in Fig. 8 shows that these factors

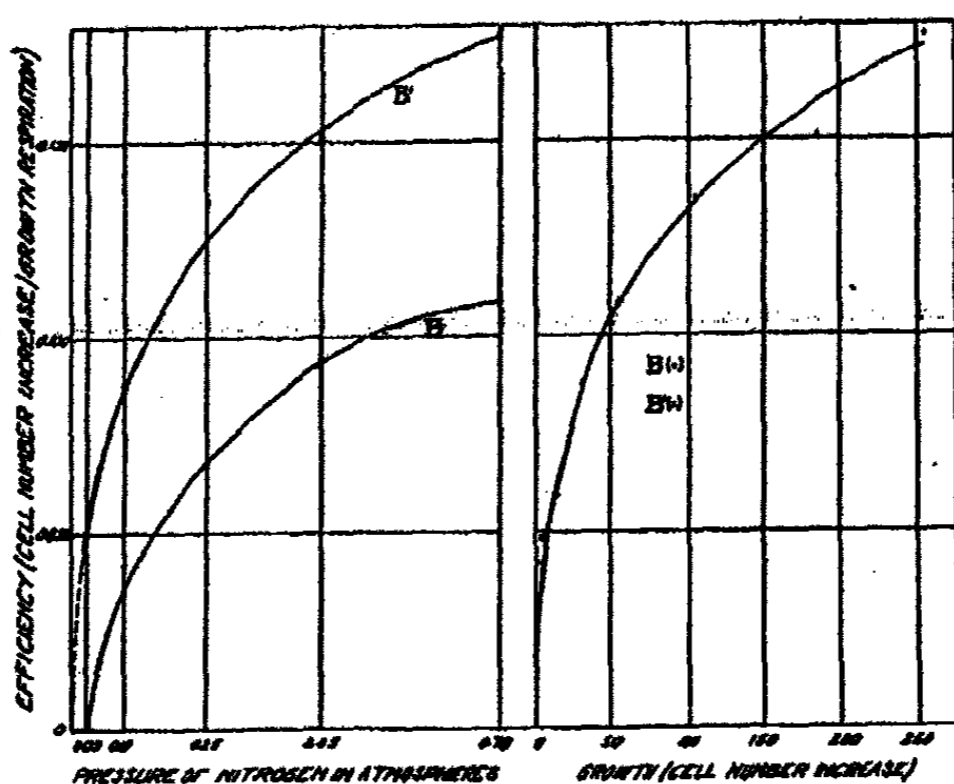

FIG. 8

Influence of Nitrogen Pressure upon Efficiency of Growth.  
 Curves B(.), efficiencies in the absence of humic acid.  
 Curves B'(x), efficiencies in the presence of humic acid.

are only indirectly effective, and influence the efficiency only so far as they influence the rate of growth. It will be noted that the first differential of efficiency with respect to growth is positive, the second negative.

The very general importance of rate of growth on efficiency also may be observed by growing *Azotobacter* in super-optimal concentrations of glucose, as shown in Table III. Gas wash bottles containing 100 cc. of inoculated culture media with, respectively and in duplicate, 1, 2, 5, and 10% glucose, were aerated with washed air at the rate of 70 liters per day for 14 days. The pH was 7.0. The nitrogen fixed was determined by the Kjeldahl method, and glucose consumption by Bertrand's method. The results are calculated per 100 cc. and as averages of duplicates. It is seen that the efficiency triples, even as the growth, or nitrogen fixation doubles.

Table II shows that at low nitrogen pressures the efficiencies of growth (calculated from the growth results, and respiration data not given) are slightly greater (1½ to 2 times) at 21%  $O_2$  than at 1%  $O_2$ . The relationship found by Meyerhof and Burk (1928) that the efficiency increases markedly

TABLE III

The Influence of Rate of Growth, determined by Super-Optimal Glucose Concentrations, upon the Efficiency of Nitrogen Fixation (and Growth)

Concentration of glucose (%)	10	5	2	1
A. Nitrogen fixed (mg.)	2.8	3.8	5.4	5.4
B. Glucose consumed (mg.)	1100	1250	980	750
Efficiency (A/B) (%)	.25	.30	.44	.72

as the pressure of oxygen is lowered, therefore becomes less and less true as the nitrogen pressure becomes more and more limiting, until, at a certain low nitrogen pressure, the converse relationship obtains. On the other hand, at 1% O<sub>2</sub>, the efficiencies are decreased 11 and 10-fold in, respectively, cultures 1 and 2, between 99% and 1% N<sub>2</sub>. Expressed more generally, when the concentration of either one of these two gases is low (i.e., 1%), a low concentration of the other results in a smaller efficiency than a high concentration, at least up to 21% O<sub>2</sub> and 99% N<sub>2</sub>. Finally, we see that higher efficiencies when humic acid is present are still obtained at 1% O<sub>2</sub> (as compared to 21% O<sub>2</sub>), at both high and low nitrogen pressures. Since none of the rates of respiration in the experiments of Table II increased appreciably, the efficiencies have therefore been calculated as cell increase /total respiration, rather than as usual, cell increase/growth respiration. The values so obtained are not as fundamentally absolute, but for comparative purposes are logically acceptable.

There is a no *a priori*, or mathematically compelling, reason for the efficiency of growth depending so strikingly upon rate of growth. One must conclude that Azotobacter is usually respiring at a rate much in excess of that needed to cover simultaneous growth and maintenance processes, the surplus respiration energy of the carbohydrate being converted irreversibly into heat, just as in a bomb calorimeter. This large "margin of safety" is very commonly observed in many other life processes, such as a muscle working (as it almost always does) under conditions of sub-maximal mechanical efficiency, and may be compared, indeed, to the fuel wasted in a steam engine wholly or partially idle, or, in a thermodynamically more general way, to the isothermal expansion of a perfect gas conducted so rapidly that heat cannot be absorbed from the reservoir sufficient to compensate for the work done (i. e., where the pv diagram no longer represents the realizable maximum external work and conditions are partially adiabatic). The very great bearing of the relationship of the rate of growth to efficiency of growth upon the energetics of nitrogen fixation by Azotobacter will be considered elsewhere.

### V. Summary

1. The chemical mechanism of nitrogen fixation at ordinary temperatures and pressures by Azotobacter has been investigated. (a) At 0.2 atmosphere of oxygen, nitrogen is fixed at an appreciable rate only above 0.05 atmosphere, and tends to reach a maximum value at about 5 to 10 atmospheres. (b) The

rate of fixation is almost directly proportional to the pressure of nitrogen between 0.05 and 0.5 atmosphere. In the presence of humic acid or 0.05 atmosphere of oxygen, which increase the rate of growth, the proportionality begins at 0 atmosphere of nitrogen.

2. The efficiency of nitrogen fixation increases markedly with the rate of fixation.

3. Although humic acid increases the rate and efficiency of nitrogen fixation, and decreases the limiting available nitrogen pressure (i.e. to below 0.05 atmosphere), it is not directly concerned in the chemical mechanism of fixation.

4. Nitrogen fixation has been established by measuring decreases of nitrogen gas, as well as increases of fixed nitrogen.

5. Analyses of time curves of fixation show that the influences of various nitrogen pressures are immediate (at least within a few minutes) and reversible.

6. The failure of legume bacteria to fix nitrogen in the absence of a host plant has been confirmed by gasometric studies under a variety of pressures of nitrogen, hydrogen, or oxygen between 0 to 1 atmosphere.

The writer is much indebted to Dr. F. G. Cottrell and Professor J. C. Drummond for suggestions and encouragement, and to Mr. Hans Lineweaver for assistance in the experimental work. Valuable criticism has been offered by Dr. F. E. Allison, Dr. Carl Iddings, and Dr. C. A. Ludwig.

*Washington, D. C.*  
*October 25, 1929.*

## THE INFLUENCE OF OXYGEN GAS UPON THE ORGANIC CATALYSIS OF NITROGEN FIXATION BY AZOTOBACTER\*

BY DEAN BURK

The nitrogen-fixing organism, *Azotobacter*, has been shown by Meyerhof and Burk<sup>1</sup> (1928) and Burk<sup>2</sup> (1930) to behave uniquely toward oxygen gas. Its rates of oxygen consumption and nitrogen fixation, and its efficiency of nitrogen fixation, are markedly conditioned by oxygen pressure in a manner characteristic of no other known living organism. (1) The rate of respiration obtains a maximum at 0.15 atmosphere, diminishing rapidly at both inferior and superior pressures, being only one-third as great at 0.005 and 1.0 atmosphere. (2) The decrease in rate of respiration between 0.2 and 1.0 atmosphere of oxygen is perfectly linear; this is true whether the complementary gas making the total pressure to one atmosphere is nitrogen or hydrogen. (3) In the absence of free or fixed nitrogen which would permit growth, the rates of respiration are independent of time at any given oxygen pressure, except in the high region of one atmosphere, where they fall off with time. Changes in rate induced by sudden changes of oxygen pressure are immediate and reversible. As will be shown, in the presence of nitrogen, increases in the rates of respiration are completely inhibited above about 0.8 atmosphere. (4) The rate of respiration is enormously high<sup>3</sup> in a young culture of *Azotobacter*, 2000 cmm. of oxygen per mg. of dry matter per hour, or about three times its own dry weight of glucose per hour. (5) The rate of nitrogen fixation obtains a maximum at 0.04 atmosphere of oxygen, being only one third to one sixth as great at about 0.008 and 0.21 atmosphere. (6) The most important influence of oxygen pressure, however, is upon the efficiency relation, nitrogen fixed/oxygen consumed, which increases some ten to twenty fold between 0.21 and 0.01 atmosphere.

It is logical to suppose that possibly these unusual metabolic properties are either the cause or the result of the similarly exceptional ability of *Azotobacter* to fix nitrogen, and that any theory of the chemical or catalytic mechanism of nitrogen fixation must provide an explanation for them. The same type of reasoning has been applied (Kostyschew, Ryskaltshuk, and Schwezowa,<sup>4</sup> 1926, Halversen,<sup>5</sup> 1927, and Ranganathan and Norris,<sup>6</sup> 1927) to the behavior of certain strains of *Azotobacter*; because ammonia was found in the circumambient fluid of organisms in young cultures of these particular

\* From the Bureau of Chemistry and Soils, Washington, D. C., and the Laboratory of General Physiology, Harvard University, Cambridge, Mass.

<sup>1</sup> Meyerhof and Burk: *Z. physik. Chem. A*, 139 (Haber-Festschrift Band), 117 (1928).

<sup>2</sup> Burk: *J. Phys. Chem.* 34, 1174 (1930).

<sup>3</sup> Warburg has shown that baker's yeast respire only 75 cmm. of oxygen per mg. of dry matter per hour, and that the rate of respiration is independent of oxygen pressure between 0.03 and 0.97 atmosphere. (*Biochem. Z.*, 189, 354 (1927)).

<sup>4</sup> Kostyschew, Ryskaltshuk, and Schwezowa: *Z. physiol. Chem.*, 54, 1 (1926).

<sup>5</sup> Halversen: *Iowa State College J. Sci.*, 1, 395 (1927).

<sup>6</sup> Ranganathan and Norris: *J. Ind. Inst. Sci.*, 10A, pt. 8, p. 79 (1927).

strains, the conclusion was drawn that ammonia was concerned in the mechanism of the chemical reaction by which fixation takes place.

However, metabolic activities of *Azotobacter* obtaining nitrogen from nitrogen gas may not be ascribed to the process of fixation itself without rigorous and simultaneous proof that organisms obtaining nitrogen from fixed nitrogen do not behave similarly. Thus, although the aforementioned strains of *Azotobacter* produce relatively large quantities of ammonia extracellularly whether growing in either nitrogen gas or nitrate, there is no reason to assume, in absence of further proof, that the ammonia was involved in their mechanism of fixation. Indeed, since these strains of *Azotobacter* reduce nitrates and nitrites to ammonia vigorously, it is equally likely that the actual mechanism of fixation involves, rather than precludes, the formation of nitrogen-oxygen compounds such as nitrates. The strains of *Azotobacter* possessed by the writer produce neither ammonia nor nitrates extracellularly during fixation, nor ammonia when nitrates are the source of nitrogen supply, and there would hardly seem reason to believe that different strains of *Azotobacter* possess different mechanisms for fixation. It does not seem probable, therefore, that an understanding of the mechanism of fixation by *Azotobacter* can be greatly advanced by means of chemical studies of nitrogen compounds found in cultures. It should be recalled that in the first work concerned with nitrogen fixation by a pure culture of an organism (Winogradsky<sup>1</sup> 1893-5) it was shown that ordinary metabolism and nitrogen fixation are two separate phenomena: so far as had been tested, the nitrogen-fixing organisms grew as other organisms did, in the presence of available energy and combined nitrogen, but in the absence of combined nitrogen and in the presence of available energy, they were able to obtain their nitrogen from the atmosphere.

The writer (1930) has established two facts concerning the mechanism of fixation free from the foregoing logical inconsistency, and it is the chief task of this paper to analyze, with similar caution, how far the unique oxygen pressure functions cited above are really concerned with nitrogen fixation, or are otherwise interpretable.

A complete description of the methods and technique employed will be found in a previous paper (Burk, 1930). The experiments have been conducted at atmospheric pressure in a Warburg micro-respiration apparatus, oxygen consumption being measured manometrically.

## I. Comparison of Oxygen Pressure Functions in Free and Fixed Nitrogen

### A. Respiration.

The initial rate of respiration in air is the same in  $\text{NH}_3\text{-N}$  (ammonia nitrogen),  $\text{NO}_3\text{-N}$  (nitrate nitrogen), and  $\text{N}_2\text{-N}$  (free nitrogen).<sup>2</sup> This finding is

<sup>1</sup> Winogradsky: *Compt. rend.*, 116, 1385 (1893); *Arch. Sci. Biol. St. Petersburg* 3, 297 (1894-5).

<sup>2</sup> It may be mentioned, incidentally, that illumination with 60-watt, 110-volt, Mazda lamps at distances of 4 inches from the culture vessels has no effect on the rate of respiration in either free nitrogen or a wide range of concentrations of fixed nitrogen over short periods of time of ten to twenty minutes, as compared with the same vessels maintained in the dark for similar periods, both before and after exposure to light.



based upon 80 experiments with  $\text{NH}_3\text{-N}$  and 16 experiments with  $\text{NO}_3\text{-N}$ , over the wide range of concentration from 0.05 to 300 mg. of N per 100 cc., and 35 experiments with  $\text{N}_2\text{-N}$  as controls. No exception to this observation has ever been observed by the writer, unless old cultures (6 days or more) were employed, as shown in Table I. That greatly decreased salt concentration, rather than advanced age, is the chief determining factor in inhibition by  $\text{NH}_3\text{-N}$ , can be seen, however, by comparing experiments 7 and 9 with 5 and 6 Table I, where, upon very high dilution of an old culture with fresh inorganic medium containing all the essential salts, the inhibiting effect vanishes. Antagonism and electrical potential differences probably play a role in  $\text{NH}_3\text{-N}$  inhibition under the conditions just outlined, and doubtless other non-nitrogenous ions cause like effects. In experiments 7 and 8 the calculated rate of respiration for 2 cc. of the original undiluted culture, 290,

TABLE I  
Initial Respiration Rate in Ammonia Nitrogen as influenced by Age of Culture and Salt Concentration

Age of Culture (Days)	1		3		9	
Experiment No.	1	2	3	4	5	6
0.2 Mg. $\text{NH}_3\text{-N}$ per 2 cc. (X)		X		X		X
Initial Respiration Rate, Cmm. per Hr. per 2 cc. of Culture	41	40	85	81	175	112
% Inhibition	0(ca')		0(ca')		36	
Age of Culture (Days)	9*		22		40†	
Experiment No.	7	8	9	10	11	12
0.2 Mg. $\text{NH}_3\text{-N}$ per 2 cc. (X)		X		X		X
Initial Respiration Rate, Cmm. per Hr. per 2 cc. of Culture	290	290	112	82	130	107
% Inhibition	0		27		18	

† *A. vinelandii* used in Experiments 11-12, *A. chroococcum* Strain SM 1 in all others.

\* 2 cc. of culture (previously continuously aerated in gas wash bottles) used in all experiments except in experiments 7 and 8, where 0.2 cc. of the same culture as used in Experiments 5 and 6 was diluted with 1.8 cc. of fresh inorganic nutrient medium (results calculated per 2 cc. culture, however, observed values being 29 and 29 cmm.).

0.5% glucose added to all cultures except in Experiments 1 and 2.  
pH constant at 7.2 in all experiments.

is considerably higher than the values in 5 or 6 (i.e. 175 and 112), so that the respiration rate in old cultures was inhibited from lack of inorganic salts (either with respect to their total concentration or certain particular ones, such as iron or calcium salts, etc.) whether the available nitrogen is free or fixed. It has been found in other experiments that if old cultures are highly

diluted with distilled water, rather than inorganic medium, the initial respiration rate is inhibited about 25% whether fixed nitrogen is present or not, showing again that salt concentration is an important factor in respiration. Occasionally the initial respiration rate is somewhat higher in  $\text{NH}_3\text{-N}$ , but this is a result of the fact that readings are not always commenced until an hour or more after the  $\text{NH}_3\text{-N}$  has been added, during which time the number of organisms, and hence the capacity for respiration may have appreciably increased, more in  $\text{NH}_3\text{-N}$  than in  $\text{N}_2\text{-N}$ . It has been shown in previous papers by the writer that in the absence of fixed nitrogen the respiration rate is independent of the presence or absence of free nitrogen at all oxygen pressures.

At all concentrations of oxygen the initial rates of respiration of young cultures which have been growing under constantly maintained conditions are neither decreased nor increased by fixed nitrogen for a period of ordinarily at least one hour after its addition to the medium containing the organisms, as shown in Tables II and III. We see that in fixed as well as in free nitrogen the initial rate of respiration passes through a maximum at about 15 to 20% oxygen, falling to about one third at 0.5% and 100%. Table IV shows that the inhibition by  $\text{NH}_3\text{-N}$  in old cultures disappears at low oxygen pressures.

TABLE II  
Respiration Rate in Free and Fixed Nitrogen as influenced by Low Oxygen Pressures

% Oxygen in Nitrogen		21	5	1	0.2
Initial Respiration	$\text{NH}_3\text{-N}$ (0.1 mg. per 2 cc.)	25.2	18.2	14.4	2.4
Cmm. per hr. per 2 cc.	$\text{N}_2\text{-N}$ 1 day old <i>A. chroococcum</i> Strain SM 1, undiluted.	25.6	17.6	14.0	2.7

TABLE III  
Respiration Rate in Free and Fixed Nitrogen as influenced by High Oxygen Pressures

% Oxygen in Nitrogen		10	20	40	60	80	100
Initial Respiration	$\text{NH}_3\text{-N}$ (0.1 mg. per 2 cc.)	42.8	44.8	41.6	35.5	25.5	16.9
cmm. per hr. per 2 cc.	$\text{N}_2\text{-N}$ 3 day old <i>A. chroococcum</i> Strain SM 1, diluted three times.	41.0	43.6	39.0	32.5	24.7	16.9

TABLE IV  
Inhibition of Respiration Rate by Ammonia Nitrogen at Low Oxygen Pressures (In Old Cultures)

% Oxygen in Nitrogen		21	5	1	0.25
Initial Respiration	$\text{NH}_3\text{-N}$ (0.1 mg. per 2 cc.)	20.0	19.4	14.5	6.5
cmm. per hr. per 2 cc.	$\text{N}_2\text{-N}$	29.8	22.0	14.0	6.8
% Inhibition	6 day <i>A. chroococcum</i> Strain SM 1, diluted seven times.	33	11	0(ca.)	0(ca.)

TABLE V  
Decrease of Respiration Rate at High Oxygen Pressures

Conditions	Gas Additional Chemi- cal Treatment	21% O <sub>2</sub> in N <sub>2</sub>	O <sub>2</sub>		90% O <sub>2</sub> , 10% N <sub>2</sub>	
			Humic Acid	Humic Acid and NH <sub>4</sub> -N	Humic Acid	NH <sub>4</sub> -N Humic acid and NH <sub>4</sub> -N
Experiment 1*	Initial	60	22.1	21.4		
Respiration Rate cmm. per hr. per 2 cc.	Final	111	11.7	12.6		
Experiment 2**	Initial	32.5		13.2	19.5	19.5
Respiration Rate cmm. per hr. per 2 cc.	Final	78.0		5.9	7.8	9.5
% Decrease	After 8 hrs.		47	41	60	51

\* 2 day old *A. chroococcum* Strain SM 1, diluted once.  
 \*\* 1 day old *A. chroococcum* Strain SM 1, undiluted.  
 Both experiments of 8 hrs. duration.  
 0.2 mg. NH<sub>4</sub>-N per 2 cc. when present.  
 0.25 mg. humic acid per 2 cc. when present.

Curve C, Fig. 1, shows that the decrease in respiration rate which takes place after organisms have been maintained in pure oxygen for an hour, or so, is independent of the presence or absence of fixed nitrogen, and that after five or six hours a practically constant and identical rate is reached by all cultures. Curves A and B, Fig. 1, concern control experiments indicating that growth in air in respectively fixed and free nitrogen was otherwise normal.

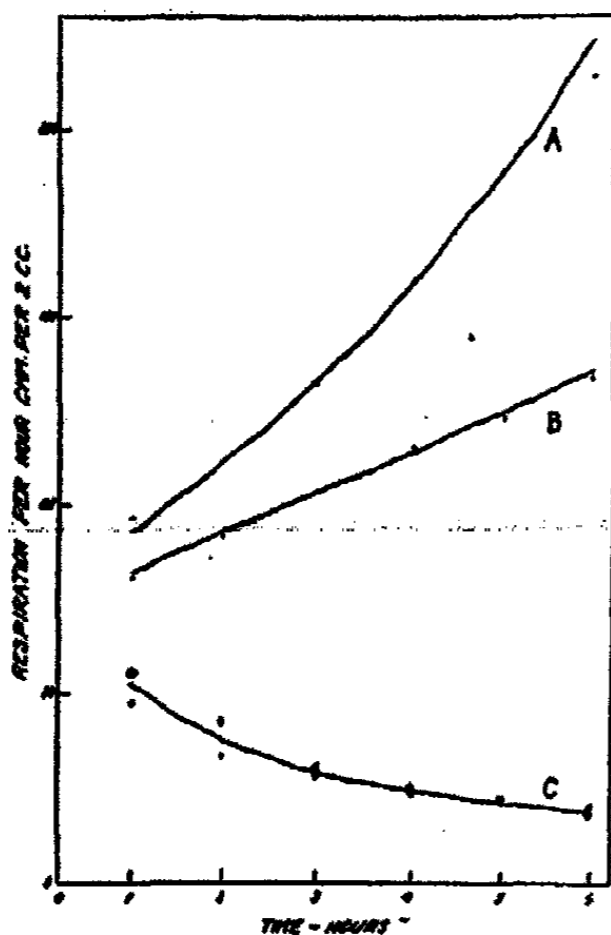

FIG. 1

The Decrease of Respiration Rate in Pure Oxygen Gas.

Curves A and B, normal rates in control cultures in air in, respectively, 0.2 mg.  $\text{NH}_3\text{-N}$  per 2 cc. and no  $\text{NH}_3\text{-N}$ .

Curve C, the fall in rate in pure oxygen with respect to time (x), average of two cultures containing no fixed nitrogen. (.), average of four cultures containing  $\text{NH}_3\text{-N}$ , at concentrations of 0.002, 0.02, 0.2, and 0.6 mg. per 2 cc. (o), average of cultures containing  $\text{NO}_3\text{-N}$ , at concentrations of 0.1 and 0.01 mg. per 2 cc. 2 day old *A. vinelandii* diluted one and one-half times.

hours. Above this pressure the rates decrease with time. Below this pressure they increase with time, passing through a maximum at about 15% oxygen. Between 5 and 40% oxygen the quantitative rate increases are greater, but at lower and higher pressures these differences do not exist, both because the respiration rates are respectively limited and inhibited to a great extent, and also because the growth rates are practically equalized. It is of great interest to note that the forms of the functions of respiration rate increase (Table VI) and respiration rate (Fig. 3, Curve A) with respect to oxygen

Table V shows that (1) in pure oxygen the same fall in rate takes place when humic acid is present (Experiment 1); (2) the same fall takes place also in 90%  $\text{O}_2$  and 10%  $\text{N}_2$  as well as in 100%  $\text{O}_2$ , in either the presence or absence of fixed nitrogen, humic acid, or humic acid and fixed nitrogen together (Experiment 2).

The striking change of respiration rate in falling from a nearly maximum value to zero as the pH is shifted only 0.2 of a unit, from 5.9 to 5.7, occurs in both free and fixed nitrogen. Indeed, in relatively weakly buffered solutions containing ammonium salts, the organisms can automatically cause their own respiration to cease when, owing to absorption of ammonium ion, the pH falls below about 5.8 as the medium becomes more acid. If the automatic cessation is allowed to take place under conditions of pure culture, not only is respiration stopped for a period of at least several months, but also consumption of reducing sugar, absorption of ammonia, and, presumably, all other measurable life processes.

Table VI shows that at about 80% oxygen, increases in the rates of respiration with respect to time are completely inhibited in both free and fixed nitrogen, the observed rates remaining approximately constant for a period of eight

TABLE VI

Respiration Rate Increase as a Function of Oxygen Pressure						
% oxygen in nitrogen		0.2*	0.8*	4	10	21
<u>Final Respiration Rate</u>	A. N <sub>2</sub> -N	1.0	1.0	2.7	3.2	2.9
<u>Initial Respiration Rate</u>						
	B. NH <sub>3</sub> -N	1.0	1.0	2.8	4.0	4.7
Ratio A/B		1.0	1.0	1.1	1.3	1.6
% oxygen in nitrogen			40	60	80	100
<u>Final Respiration Rate</u>	A. N <sub>2</sub> -N		1.8	1.6	1.0	0.4
<u>Initial Respiration Rate</u>						
	B. NH <sub>3</sub> -N		3.5	1.6	1.0	0.4
Ratio A/B			1.9	1.0	1.0	1.0

3 day old *A. chroococcum* Strain SM 1, diluted three times. Experiment of 8 hours duration.

\* Data taken from other experiments.

pressure are the same, emphasizing once again (as also by Burk, 1930, Fig. 8, and Fig. 2 of this paper) how the increase of capacity to respire is, in the unusual case of *Azotobacter*, by no means strictly directly proportional to the growth as one ordinarily would expect, *a priori*, but is markedly affected by oxygen pressure, also.

#### B. Growth

Table VII shows that growth in fixed nitrogen, just as in free nitrogen, reaches a maximum at lower oxygen concentrations than in air, 2 to 4%, and that the rates at 21% are no greater than those at somewhat below 1%. It will be observed that at 0.25% the growth in free and fixed nitrogen is approximately the same, a finding which has been verified many times, altho the situation is different at 21%, growth being greater in NH<sub>3</sub>-N.

As shown in Table VIII, the amount of respiration is no longer useful as an indirect measure of growth where different oxygen pressures are concerned. In spite of maximum growth occurring at about 4% of oxygen, the total respiration progressively decreases as the oxygen pressure is lowered from, or increased above, 21% oxygen. This is true whether the cultures are grown in free or fixed nitrogen.

One must not conclude from Table V that growth is completely inhibited at 90% and 100% oxygen. Although no appreciable growth, as determined by turbidity measurements, has occurred in eight hours, by twenty-three hours growth was distinctly visible in all cultures, either in the absence or presence of fixed nitrogen or humic acid at 10% N<sub>2</sub> in 90% oxygen, or in the presence of humic acid and fixed nitrogen at 100% O<sub>2</sub>. The growths in fixed nitrogen were relatively heavy, a finding which has been confirmed several times, but, in its absence, growth in 90% oxygen was small, owing to the low nitrogen pressure available. The growth in fixed nitrogen was smaller

TABLE VII

The Influence of Oxygen Pressure upon Rate of Growth in Free and Fixed Nitrogen

Experiment No. 1 <sup>a</sup>	% Oxygen	21	5	1	0.25
	Count Increase (8 hrs.)	60	110	104	58,64*
Experiment No. 2 <sup>b</sup>	% Oxygen	21	7	4	1
	Count Increase (10 hrs.)	4	21	51	43
Experiment No. 3 <sup>c</sup>	% Oxygen	60	21	4	2
	Count Increase (7 hrs.)	2	6	70	50
Experiment No. 4 <sup>d</sup>	% Oxygen	60	4	1	
	Count Increase (13 hrs.)	40	260	84	
Experiment No. 5 <sup>e</sup>	% Oxygen	21	21	0.8	0.8
	NH <sub>3</sub> -N (x)		(x)		(x)
	Count Increase (12 hrs.)	32	64	56	46
Experiment No. 6 <sup>f</sup>	% Oxygen	0.5	0.5	0.5	0.5
	Concentration of NO <sub>2</sub> -N	0	0.01	0.04	0.20
	Count Increase (24 hrs.)	17	16	17	20

Experiments 2 and 3 in free nitrogen; 1, 4, and 5 with 0.1 mg. NH<sub>3</sub>-N per 2 cc.; 6 with NO<sub>2</sub>-N as indicated, in mg. per 2 cc.

- 6 day old *A. chroococcum* Strain SM 1, diluted 7 times. Initial count, 50 millions per 2 cc. 0.1 mg. NH<sub>3</sub>-N except in (\*) where nitrogen source is N<sub>2</sub> only.
- 3 day culture diluted 8 times. Initial count 9 millions per 2 cc.
- 2 day culture. Initial count 20 millions per 2 cc.
- 2 day culture diluted 3 times. Initial count 12 millions per 2 cc. 0.1 mg. NH<sub>3</sub>-N per 2cc
- 2 day culture diluted 2 times. Initial count 20 millions per 2 cc. 0.1 mg. NH<sub>3</sub>-N when present.
- 4 day culture diluted 0 times. Initial count 6 millions per 2 cc.

at 100% oxygen than at 90% oxygen. More long-duration experiments in these high regions of oxygen pressure are desirable, but the important point has been sufficiently established that growth takes place in the presence of both free and fixed nitrogen at oxygen concentrations at least as high as 90%. In the foregoing preliminary experiments, the rates of respiration were observed to commence to rise by twenty-three hours, slowly, however. It is conceivable that the efficiency of growth also rises, since the relative respiration rate increases may be smaller than the relative growth increases. This would imply that the efficiency may pass through a minimum at about 60% oxygen, when experiments are of sufficient duration, rather than falling to approximately zero at this concentration, as in the case of short time experiments of eight to twelve hours. (See Fig. 3 and Table VII, Experiment No. 3).

TABLE VIII  
The Influence of Oxygen Pressure upon Total Respiration in Free and Fixed Nitrogen

Experiment No. 1 <sup>a</sup>	% Oxygen	100	80	60	40	21	10	4
NH <sub>3</sub> -N	Total Respiration	86	203	390	650	981	806	700
	ccm. per 8 hrs. per 2 cc.							
N <sub>2</sub> -N		86	270	335	343	598	545	526
Experiment No. 2 <sup>b</sup>	% Oxygen	60	21	4.5	1	0.12		
NH <sub>3</sub> -N	Total Respiration							
	ccm. per 13 hrs. per 2 cc.	230	951	610	169	16		
Experiment No. 3 <sup>c</sup>	% Oxygen		21	5	1	0.25		
NH <sub>3</sub> -N	Total Respiration		1095	339	133	28		
	ccm. per 11 hrs. per 2 cc.							
N <sub>2</sub> -N			724	369		31		
Experiment No. 4 <sup>d</sup>	% Oxygen		21	5	1	0.25		
NH <sub>3</sub> -N	Total Respiration							
	ccm. per 8 hrs. per 2 cc.		570	370	200	61		
N <sub>2</sub> -N			443	279	195	72		
Experiment No. 5 <sup>e</sup>	% Oxygen	100	21					
NH <sub>3</sub> -N	Total Respiration							
	ccm. per 6 hrs. per 2 cc.	189	1039					
NO <sub>2</sub> -N		202	926					
N <sub>2</sub> -N		198	723					
Experiment No. 6 <sup>f</sup>	% Oxygen		21					0.8
NH <sub>3</sub> -N	Total Respiration							278
	ccm. per 8 hrs. per 2 cc.		1295					278
N <sub>2</sub> -N			965					

a. 3 day culture diluted 3 times. 0.2 mg. NH<sub>3</sub>-N per 2 cc. when present.

b. 2 day culture diluted 5 times. 0.1 mg. NH<sub>3</sub>-N per cc.

c. 1 day culture diluted 0 times. 0.1 mg. NH<sub>3</sub>-N per 2 cc. when present.

d. 6 day culture diluted 7 times. 0.1 mg. NH<sub>3</sub>-N per 2 cc. when present.

e. 2 day culture diluted 1½ times. 0.6 mg. NH<sub>3</sub>-N per 2 cc. when present.

f. 2 day culture diluted 2 times. 0.2 mg. NH<sub>3</sub>-N per 2 cc. when present.

All cultures *A. chroococcum* Strain SM 1 except *A. vinelandi* in Experiment 1

## C. Efficiency

The most striking oxygen pressure function, efficiency, increases with lower oxygen pressures similarly in both free and fixed nitrogen, as shown in Curve A, Fig. 2. The points (.) and (x), efficiencies of fixation in free nitrogen and growth in fixed nitrogen, respectively, have been plotted relatively to each other by making points at 0.21 atmosphere of oxygen identical. Curve A shows how closely all the points may fit together on the same curve. Actually, of course, the efficiencies of growth in free and fixed nitrogen are equal at very low oxygen pressures, and somewhat greater in fixed nitrogen at 0.21 atmos-

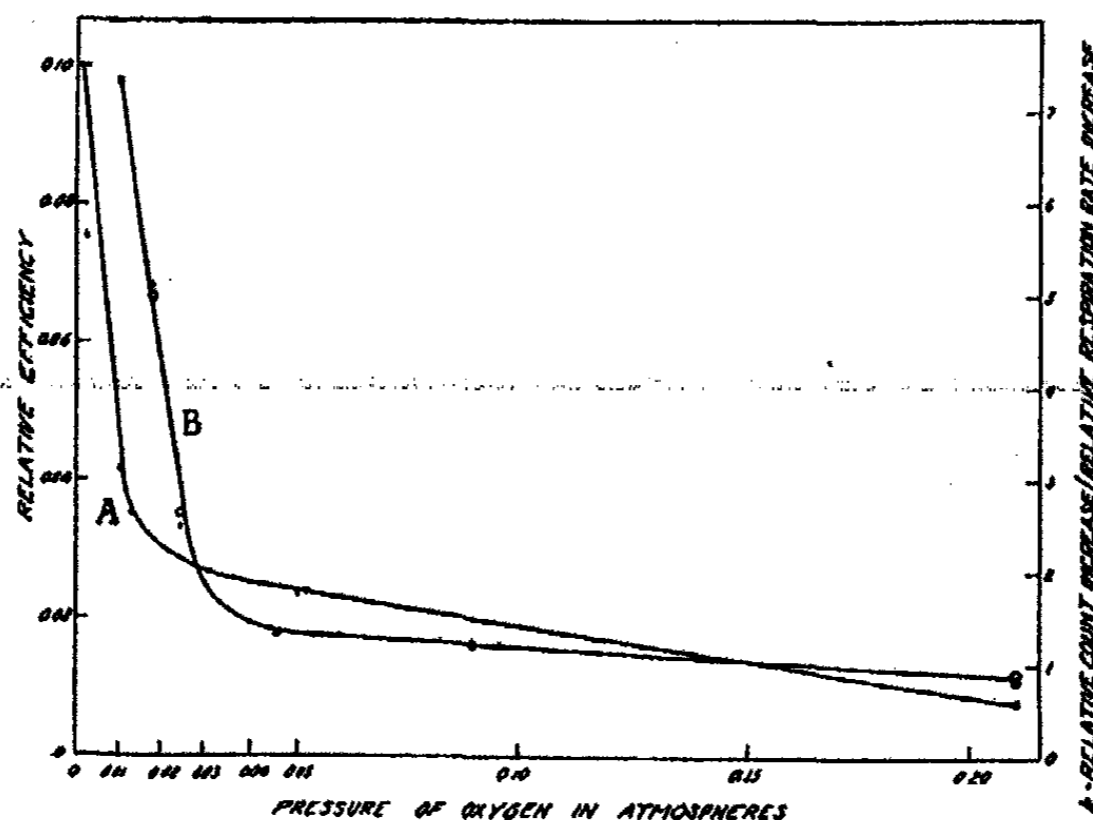

FIG. 2

The Ratio of Growth to Growth Respiration at Different Oxygen Pressures.

Curve A, (.), efficiency of growth or nitrogen fixation (nitrogen fixed/total respiration), in the absence of fixed nitrogen, taken from Meyerhof and Burk (1928, loc. cit.); (x), efficiency of growth (count increase/total respiration) in the presence of 0.1 mg.  $\text{NH}_4\text{-N}$  per cc. Curve B, the ratio of fractional count increase to fractional growth respiration increase; ( $\square$ ), in 0.1 mg.  $\text{NH}_4\text{-N}$  per 2 cc., (.), in free nitrogen, (o), the ratio of fractional nitrogen fixed to fractional growth respiration in free nitrogen, for the same experiment as given by (x). Both experiments of 8 hrs. duration.

phere, usually about one and one half to two fold. The (x) points on Curve A would have shown this if the points (x) and (.) at the lowest oxygen pressures, rather than those at 0.21 atmosphere, had been made identical. The increase of efficiency between 0.21 and 0.005 atmospheres is therefore slightly less in the case of fixed nitrogen as compared with free nitrogen.

While Curve B, Fig. 2, is not an exact measure of efficiency it is an equally satisfactory one, not only by definition, but as shown by the actual qualitative agreement with Curve A itself.  $k$  is defined as (count increase/initial count)  $\div$  (respiration rate increase/initial respiration rate).  $k$  varies in free and fixed nitrogen similarly. The points (.) and (o) show that little difference is made whether  $k$  and efficiency are defined in terms of either growth or nitrogen fixation; as has often been pointed out before, the strain of *Azotobacter* used excretes no fixed nitrogen extracellularly, and growth is strictly proportional to the amount of nitrogen fixed.



## II. Miscellaneous Functions in Free and Fixed Nitrogen

It has been shown by Burk (1930) that the efficiency of growth in free nitrogen is markedly affected by the rate of growth, as conditioned by either the pressure of nitrogen gas or the presence of humic acid. While not an oxygen pressure function, it may be well to mention here that the efficiency of growth in fixed nitrogen is equally markedly affected by the rate of growth as conditioned by the concentration of  $\text{NH}_3\text{-N}$  (see Table IX).

TABLE IX

Efficiency of Growth in Fixed Nitrogen as a Function of Rate of Growth					
$\text{NH}_3\text{-N}$ , mg. per 2 cc.	0	0.002	0.006	0.01	0.1
Count increase, millions per 2 cc.	0	6	38	54	66
Efficiency (growth/growth respiration)	0	0.05	0.35	0.42	0.56
$k^*$	0	0.314	1.73	2.81	3.65

3 day old *A. chroococcum* Strain SM 1, diluted 3 times.  
Initial count, 22 millions per 2 cc.  
10% oxygen in hydrogen.  
\* is defined as in Fig. 2.

TABLE X

The Influence of Humic Acid upon Various Physiological Functions in Free and Fixed Nitrogen

Condition	$\text{N}_2\text{-N}$	$\text{N}_2\text{-N}$ and Humic acid	$\text{NH}_3\text{-N}$	$\text{NH}_3\text{-N}$ and Humic acid
Initial Respiration Rate cmm. per hr. per 2 cc.	8	8	8	8
Final Respiration Rate cmm. per hr. per 2 cc.	105	160	188	416
Total Respiration cmm. per 13 hrs. per 2 cc.	564	749	796	1285
Count Increase millions per 2 cc.	39	145	555	1295
Efficiency*	0.085	0.225	0.802	1.35
$k$	0.643	1.53	4.94	6.25

1 day old *A. chroococcum*, Strain SM 1, undiluted. Initial count, 5 millions per 2 cc.  
0.1 mg.  $\text{NH}_3\text{-N}$  when present.  
0.25 mg. humic acid per cc. when present.  
Duration of experiment, 13 hrs.  
\* Efficiency and  $k$  as defined in Table IX.

It may also be pointed out that where humic acid influences physiological behavior in free nitrogen it does so likewise in fixed nitrogen. Table X shows that humic acid causes increases in both free and fixed nitrogen with respect to initial respiration rate, final respiration rate, total respiration, growth, efficiency, growth, efficiency and  $k$ . The initial respiration is independent of  $\text{N}_2\text{-N}$ ,  $\text{NH}_3\text{-N}$ , and humic acid, of course, within experimental error.

### III. The Mechanism of Respiration

Since it has been shown that nitrogen fixation has no specific influence upon the unique oxygen pressure functions of respiration by *Azotobacter*, it is obviously desirable and indeed somewhat imperative, to interpret the latter according to modern theories of reaction kinetics. The striking fact that oxygen when present in excess should inhibit the rate of its own consumption is very surprising, since from the point of view of the kinetic theory it seems strange that collisions between oxygen and glucose molecules should produce less and less chemical action as their frequency of occurrence per unit of volume is increased. Such an ostensible infraction of the mass law recalls the similar catalytic reaction between phosphorus and oxygen, where, as Lord Rayleigh<sup>1</sup> has shown (1921-23), the rate at room temperature is similarly decreased by increases of oxygen pressure over the approximate range of 0.01 to 1 atmosphere. Altho many organic oxidation reactions show strong susceptibility to inhibition, it is seldom that the inhibitor is one of the reactants.

#### A. Chain Kinetics

In explaining the phosphorus reaction, Hinshelwood<sup>2</sup> (1929) and Semenov<sup>3</sup> (1927) have employed the recently developed conception that exothermal chemical changes sometimes occur by chain mechanisms, according to which the first transformation yields a product endowed with an excess of energy which initiates a further change, the cycle being repeated until the chain is broken by the destruction or deactivation of the active intermediate in some secondary process.<sup>4</sup> In the case of respiration by *Azotobacter*, one can postulate, analogously, that, owing to its high energy content, the first reaction product between oxygen and the organic compound (catalytically formed by the respiration enzyme) propagates reaction chain compounds like itself, quite independently of the respiration enzyme; collision of the active intermediate with oxygen (corresponding to the above mentioned secondary process) results in deactivation, however, so that with increasing pressures of oxygen above a certain limit the observed rate of respiration falls, being controlled more and more by the respiration enzyme alone. Possible additional evidence of respiration by *Azotobacter* involving a chain reaction might be inferred from its extremely high respiration rate as compared with other organisms, mentioned in the introduction.

#### B. Contact Catalysis

However, still another entirely different, but equally likely, alternative theory is possible, similar to that given by Langmuir<sup>5</sup> (1922) to explain the inhibiting action of hydrogen in the formation of water, or carbon monoxide

<sup>1</sup> Lord Rayleigh: Proc. Roy. Soc., 99A, 372 (1921); 104A, 322 (1923).

<sup>2</sup> Dalton and Hinshelwood: Proc. Roy. Soc., 125A, 294; Thompson and Hinshelwood: 277 (1929).

<sup>3</sup> Semenov: Z. Physik, 46, 109 (1927).

<sup>4</sup> Altho Rayleigh originally advanced an explanation of the phosphorus reaction based on contact catalysis, this is no longer required, since the reaction has been shown more recently to take place in the gas phase. Moreover, the chain reaction mechanism is made much more probable since light is emitted during the reaction.

<sup>5</sup> Langmuir: Trans. Faraday Soc., 17, 607-54 (1922).

in the formation of carbon dioxide, platinum being used as a solid catalyst in both cases. In such bimolecular reactions it may be postulated that either one or both of the reactants must make contact with the solid catalyst before combination may take place. Under this conditioning circumstance, there will always be a certain distribution ratio between the reactants at which the rate will be a maximum.

Curves A and B, Fig. 3, show that in the case of Azotobacter the respiration rate functions of *both* oxygen pressure and glucose concentration pass

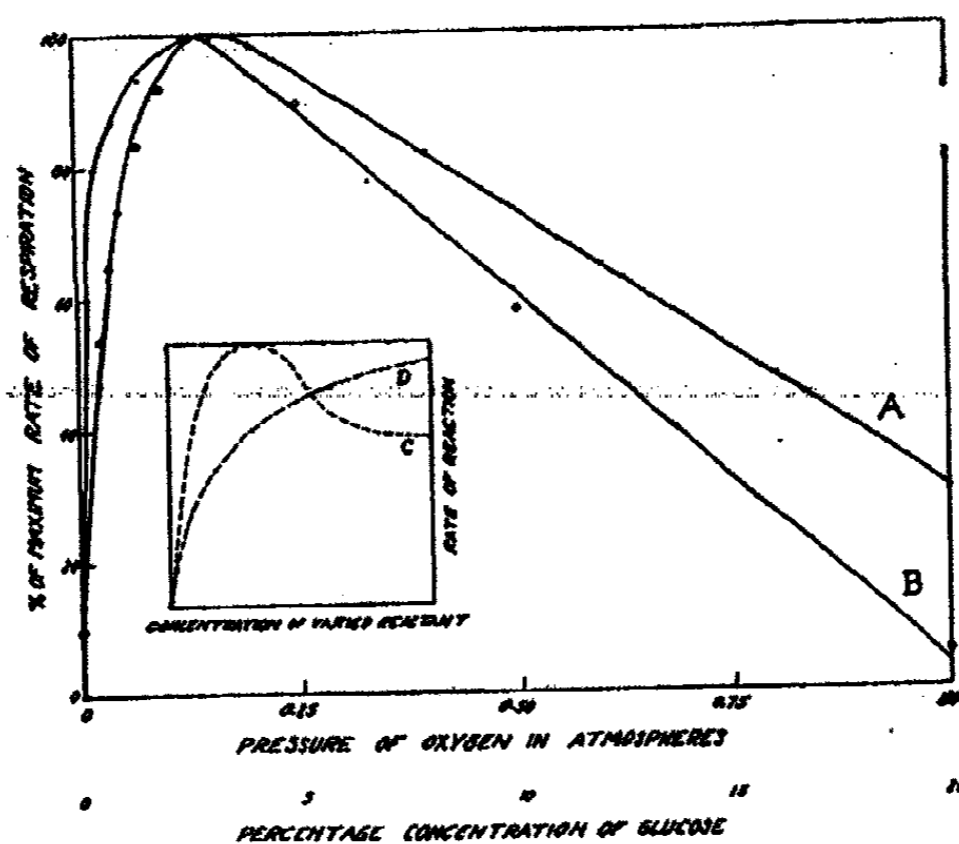

FIG. 3

Respiration Rate as a Function of Oxygen and Glucose.

Curve A, rate of respiration at different pressures of oxygen, glucose concentration being kept constant at 1%. Based upon three particular experiments.

Curve B, rate of respiration at different concentrations of glucose, oxygen pressure being kept constant at 0.21 atmosphere. Based upon four particular experiments.

Curve C, hypothetical curve, passing through a maximum and falling to a constant value, obtained where not only both reactants react when adsorbed side by side on the solid catalyst but also when one unadsorbed reactant may react by bombardment with the other adsorbed reactant.

Curve D, hypothetical curve rising to a constant but not maximum value obtained when (for the most part, at least) both reactants are not adsorbed side by side but either one or the other may react by bombardment with the other when adsorbed.

thru a maximum. Hence, according to the above postulate, *both* oxygen and glucose (or a derivative of glucose) *must* be in contact with the solid respiration enzyme,<sup>1</sup> adsorbed side by side, in order for the reaction to take place measurably. In accordance with this view, further, neither unadsorbed oxygen nor unadsorbed glucose are able to react by bombardment with, respectively, adsorbed glucose or adsorbed oxygen, otherwise Curves B or A,

<sup>1</sup> Warburg (Naturwissenschaften, 16, 345 (1928)) has given evidence that the respiration enzyme exists in the living cell in a solid state. He has also shown (Biochem. Z., 189, 354 (1927)) that the first reaction by oxygen in respiration is with the iron molecule of the respiration enzyme, which is in accord with the second explanation, and rather strong evidence for its probability in preference to the chain reaction explanation.

respectively, would have been similar in form to Curve C, Fig. 3. Curves B and A, it will be seen, give no experimentally detectable indication of leveling out to a constant value after passing through the maximum. The linear fall in each curve excludes the possibility of any experimentally significant and appreciable fraction of the respiration rate being contributed to by bombardments made by those oxygen or glucose molecules which never make contact with the catalyst. Curve D shows the nature of the curve which would have been obtained were the reaction based not upon both reactants being adsorbed side by side on the solid catalyst, but upon one reactant (or the other, or even neither) being adsorbed, and the other reactant (unadsorbed) striking it by bombardment; the function increases continuously and never deflects downward. In Curve C both bombardment and side by side adsorption take place, and a constant value is approximated after the maximum has been passed through.

It should be noted that for small concentrations of both reacting substances the reaction velocities are proportional to the concentrations of either reactant. In addition, the maximum velocity with respect to any one variable will always occur at any concentration of the other. However, as Constable<sup>1</sup> (1928) has shown, the maximum velocity does not in general occur when the concentrations of the reactants are in the ratio suggested by the chemical equation of the reaction, (as is true, somewhat analogously, in equilibrium cases with respect to maximum yield of resultants dependent upon a particular ratio of initial concentrations of reactants). Thus, in Curve A, the oxygen concentration in the medium at maximum rate is 0.00018 M (0.15 at. x 0.027/22.4), whereas the glucose concentration is 0.055 M (1%), or a ratio of 0.0033; in Curve B, the oxygen concentration is 0.00024 M (0.21 at. x 0.027/22.4), whereas the glucose concentration at maximum rate is 0.15 M (2.8%), or a ratio of 0.0016; the entirely different ratio suggested by the chemical equation is, of course, 6.

The two foregoing general explanations of the mechanism of respiration by *Azotobacter* are the only important ones which appear to the writer to be consistent with all the available data. The fact that the reversible negative rate functions at higher pressures of oxygen are linear and therefore mathematically simple may conceivably, and even probably, allow a decision between them; at present, of course, the quantitative relations of neither explanation have been worked out sufficiently to permit this differentiation. One of the chief points of interest in connection with the second explanation offered is that cases where both reactants *must* be adsorbed side by side for combination to take place are much more unusual than where only one reactant must be adsorbed and be bombarded by the other. Moreover, with such a postulated mechanism it is difficult to see how either nitrogen gas or the process of nitrogen fixation is in any way involved in the mechanism of respiration.

<sup>1</sup> Constable: Proc. Camb. Phil. Soc., 24, 56 (1928).

#### IV. Summary

1. The unique oxygen pressure functions of *Azotobacter* with respect to respiration, growth, efficiency of growth, pH, and humic acid obtain in both free and fixed nitrogen. Hence they offer no indication as to the nature of the chemical mechanism of nitrogen fixation.

2. The mechanism of respiration has been interpreted in terms of both chain reaction kinetics and contact catalysis. With respect to the latter, the data presented are consistent with the view that both oxygen and the organic molecule oxidized must be in contact with the solid respiration enzyme catalyst in order for the reaction to take place measurably, bombardments by unadsorbed molecules being ineffective.

The writer takes pleasure in acknowledging assistance and criticism offered by Professor W. J. Crozier, Dr. P. H. Emmett, Dr. O. R. Wulf and Dr. F. E. Allison.

*Washington, D. C.*  
*November 16, 1929.*

## THE PREPARATION OF GALLIUM TRIBROMIDE AND GALLIUM TRIIODIDE\*

BY WARREN C. JOHNSON AND JAMES B. PARSONS

Lecoq de Boisbaudran and E. Jungfleisch<sup>1</sup> announced many years ago that metallic gallium reacts with chlorine, bromine and iodine to form the corresponding halides. They described the relative intensities of the reactions as being in the usual order, and the boiling points and melting points of the compounds as increasing with increasing atomic weight of the halogen. Shortly following this announcement, Lecoq de Boisbaudran<sup>2</sup> made a very brief statement regarding the preparation of several chlorides, bromides and iodides of gallium. He later showed that two chlorides of gallium, namely, gallium dichloride<sup>3</sup> and gallium trichloride,<sup>4</sup> are readily formed by the direct combination of the elements. The existence of these two chlorides was substantiated by quantitative data. Although the reactions of bromine and iodine with metallic gallium are described by this investigator, there is no evidence to show that these halides were ever analyzed or studied, nor is any mention made of the technique employed in their preparation. According to the literature no attempts have ever been made to prepare a fluoride of gallium.

In the present investigation gallium tribromide and gallium triiodide are prepared and some of the physical properties of the compounds are determined in order to further our knowledge of the chemistry of this relatively unknown element. Qualitative experiments are carried out to show that a fluoride of gallium exists.

### Source of Material

The gallium used in the investigation was obtained from the mineral germanite<sup>5</sup> whose gallium content varies from 0.5-0.75 percent.<sup>6</sup> After the germanium<sup>7</sup> had been removed from the mineral, the gallium was extracted with hydrochloric acid according to the procedure of Kraus, Johnson and Foster.<sup>8</sup> In order to obtain a pure product, the gallium hydroxide was reprecipitated several times by means of sodium acid sulfite. The hydroxide

\* Contribution from the Kent Chemical Laboratory of the University of Chicago.

<sup>1</sup> Lecoq de Boisbaudran and E. Jungfleisch: *Compt. rend.*, 86, 577 (1878).

<sup>2</sup> Lecoq de Boisbaudran: *Compt. rend.*, 86, 756 (1878).

<sup>3</sup> Lecoq de Boisbaudran: *Compt. rend.*, 93, 294 (1881).

<sup>4</sup> Lecoq de Boisbaudran: *Compt. rend.*, 93, 329 (1881).

<sup>5</sup> Pufahl: *Metall. u. Erz.*, 19, 324 (1922); Kriesel: 20, 257 (1923).

<sup>6</sup> Kriesel: *Chem. Ztg.*, 48, 961 (1924); Lunt: *S. African J. Sci.*, 20, 157 (1923); Kiel: *Z. anorg. Chem.*, 152, 101 (1926).

<sup>7</sup> A pyrogenic process for the removal of germanium from germanite ore was described by Kraus and Johnson at the Swampscott Meeting of the American Chemical Society, September, 1928.

<sup>8</sup> A report of this extraction process was given by L. S. Foster at the Swampscott Meeting of the American Chemical Society, September, 1928. The results of the methods for both germanium and gallium will constitute the subjects of forthcoming publications.

was dissolved in potassium hydroxide and the solution was electrolyzed.<sup>9</sup> Metallic gallium collected at the cathode as a small metallic-appearing ball which dropped into a cup below the electrode. Although the electrolysis was carried out at room temperature, sufficient heat was generated at the cathode to keep the metal in a molten condition. (The melting point of gallium is  $29.75^{\circ}$ ). The gallium was purified by fractional crystallization on a platinum wire from the supercooled liquid metal.<sup>10</sup>

#### Gallium Tribromide

*Preparation.* Gallium tribromide was prepared by the direct combination of the elements in vacuo. Metallic gallium (about 1 g.) was introduced into a Pyrex tube as one solid piece. As soon as the tube was sealed off, the entire system was evacuated by means of a mercury vapor pump supported by a Hy-Vac oil pump. Liquid bromine, which had previously been twice distilled from phosphorus pentoxide, was then distilled in vacuo into the tube containing the gallium which was cooled to  $-33.5^{\circ}$  by means of a Dewar flask of liquid ammonia.

The gallium reacted with the bromine very rapidly at the temperature of the boiling point of liquid ammonia. At room temperature and even at  $0^{\circ}$ , the metal reacted on the surface of the liquid bromine in much the same manner as does an alkali metal on the surface of water. A considerable amount of energy was liberated both in the form of heat and light. When the initial and more vigorous reaction was over, the mixture was allowed to stand for two days to insure complete reaction, the excess bromine was removed by condensation into a small side tube, which was then sealed off from the main reaction tube, and finally the entire system was evacuated to a pressure of 0.001 mm. Under this low pressure the salt began to sublime at  $90^{\circ}$  into the neck of the reaction tube. This process was greatly hastened by increasing the temperature to about  $125^{\circ}$ . When the major part of the salt had

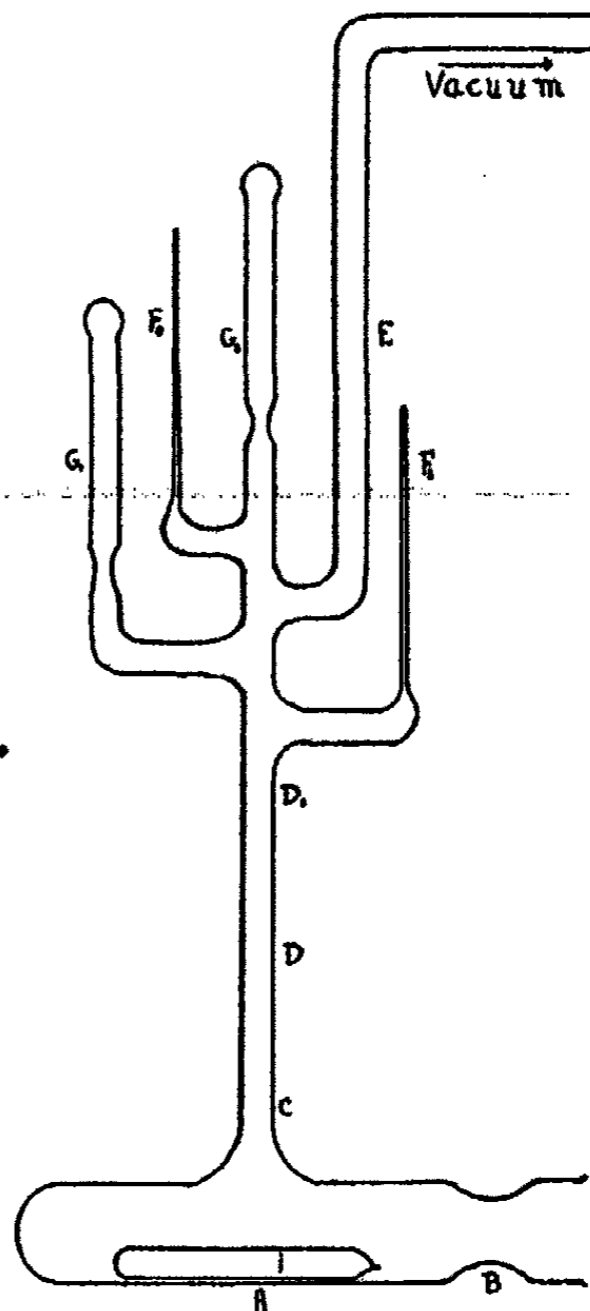

FIG. 1.  
Apparatus for the Sublimation of  
Gallium Tribromide and Gallium  
Triiodide.

<sup>9</sup> No definite procedure was followed in the electrolysis of this alkaline solution. The current density was varied to obtain the greatest yield of metal, but the results were found to be quite inconsistent even when the same conditions were thought to have been employed in different experiments.

<sup>10</sup> Richards and Boyer: *J. Am. Chem. Soc.*, 43, 274 (1921).

sublimed into a limited space in the tube, it was sealed off from the system. This tube, containing the gallium bromide, was scratched with a file, cracked slightly with a fine hot glass rod, and then introduced into a larger tube, A, as shown in Fig. 1. After sealing off the system at B, the entire apparatus was exhausted to a low pressure. The tube containing the salt was then broken by applying a slight jar in the vicinity of A. A Crisco bath was placed about the apparatus and heated to  $140^{\circ}$  at which temperature sublimation of the salt into D took place rapidly. Then A was removed by sealing off at C. The smaller tube D was of such a length as to allow for several successive sublimations. The tube was finally sealed off at D<sub>1</sub> and the salt was then sublimed into the various branches above. F<sub>1</sub> and F<sub>2</sub> represent melting point tubes while G<sub>1</sub> and G<sub>2</sub> are small tubes to collect samples of the salt for analysis. During the process of sublimation some of the salt appeared in E. It was thus possible to obtain several small samples of the bromide of high purity for carrying out analyses and determining some of its physical properties.

*Analysis.* A sample of the salt which had been sublimed several times was sealed off in a tube (G<sub>1</sub>, Fig. 1). The tube was scratched, washed with alcohol and ether and then weighed. It was broken and then dropped immediately into water where the salt dissolved quickly. The parts of the tube were removed, washed, dried and weighed in order to obtain the weight of the dissolved salt. Two aliquot parts of the solution were analyzed for bromine by the usual gravimetric method of precipitation as silver bromide.

Anal. Subs., 0.3226, 0.3893; AgBr, 0.5861, 0.7072. Calc. for GaBr<sub>3</sub>: Br, 77.47. Found: 77.31, 77.31.

The third aliquot sample was analyzed for gallium by precipitation of the hydroxide with ammonium acid sulfite according to the procedure described by Porter and Browning.<sup>11</sup>

Anal. Subs., 0.3642. Ga<sub>2</sub>O<sub>3</sub>, 0.1098. Calc. for GaBr<sub>3</sub>: Ga, 22.53. Found: 22.43.

*Melting Point.* Several melting point determinations were carried out with three different samples of gallium tribromide and in each case a value of 122.5 was obtained.

*Density.* The density of gallium tribromide was determined at  $120^{\circ}$  and at  $125^{\circ}$ . Ordinary methods could not be used due to the hygroscopic nature of the salt and the small quantity available. Nor was it found feasible to determine the density of the solid salt as it showed a marked tendency to contract from the walls of glass upon solidification. It was accordingly found necessary to determine the density of the fused substance. This was accomplished by comparing the weight of the melted salt at  $120^{\circ}$  and  $125^{\circ}$  with the weight of an equal volume of mercury at the same temperatures.

The mercury was purified according to the method of Hulett and Minchin.<sup>12</sup> The gallium bromide was subjected to several sublimations for

<sup>11</sup> Porter and Browning: J. Am. Chem. Soc., 41, 1491 (1919).

<sup>12</sup> Hulett and Minchin: Phys. Rev., 21, 389 (1905).



purification and then sealed in Pyrex capillary tubes of uniform bore. The inner diameter of the capillary tube was determined by weighing a given length of mercury, the length being measured with a travelling microscope. The menisci were read with a cathetometer. A meniscus correction was applied by assuming a value of one-third the radius of the tube for the height above the bottom of the meniscus. The following values for the density were obtained:

Diameter of Tube	Temperature	Density
0.1205 cm.	120°	3.123
0.1215	120	3.138
0.1205	125	3.095
0.1215	125	3.109

*Other Properties.* Gallium tribromide is a white crystalline substance melting at 122.5°. It dissolves readily in water undergoing hydrolysis. It is exceedingly hygroscopic. The salt begins to sublime at 90° when subjected to a pressure of 0.002 mm. No decomposition occurs when it is sublimed and melted. When melted and then allowed to cool, it appears to supercool several degrees.

In the initial preparation of gallium tribromide a residue remained in the reaction tube which did not sublime with the bulk of the material. When it was subjected to a much higher temperature, about 200°, a small quantity of a white salt appeared on the walls of the tube above the bath. This substance may be a lower bromide of gallium due to a reaction between the normal bromide and free gallium. Its properties will be described in a later paper.

#### Gallium Triiodide

*Preparation.* This salt was likewise prepared by the direct union of the elementary constituents. Resublimed iodine was dried for several days over phosphorus pentoxide. The metallic gallium was purified by crystallization. Equivalent quantities of these two elements were reacted in a small Pyrex tube in the absence of air and moisture. Reaction did not take place at room temperature;<sup>13</sup> however, on warming gently with a flame, a vigorous reaction followed with the evolution of much heat and light. A crust of the iodide, which appeared to form on the surface of the small pieces of metallic gallium, was removed by shaking the tube and subsequent heating. By repeating this process several times, it was found possible to complete the reaction. The tube was then cracked and placed in a larger tube, A, as shown in Fig. 1. Several sublimations of the salt were carried out to obtain samples of a pure product. The same general procedure was followed as in the case of gallium tribromide.

*Analysis.* Two samples were analyzed for iodine by the usual method of precipitation as silver iodide.

<sup>13</sup> Reaction would undoubtedly have taken place here providing the constituents were in a finely divided condition.

Anal. Subs., 0.0290, 0.1604: AgI, 0.0453, 0.2505. Calc. for  $\text{GaI}_3$ : I, 84.53. Found: 84.44, 84.42.

The gallium was determined by precipitation of the hydroxide with ammonium acid sulfite and weighed as  $\text{Ga}_2\text{O}_3$  according to the previously described procedure.

Anal. Subs., 0.3300, 0.2521:  $\text{Ga}_2\text{O}_3$ , 0.0690, 0.0516. Calc. for  $\text{GaI}_3$ : Ga, 15.47. Found: 15.55, 15.58.

*Melting point.* The melting point of gallium triiodide was found to be at  $213.5^\circ$ . A slight amount of decomposition evidently takes place at this temperature since the liquid appears darker than the original salt. The color, amber to red, is probably due to the presence of a small amount of free iodine.

*Color.* Gallium triiodide is a lemon yellow crystalline substance at ordinary temperatures. Lecoq de Boisbaudran undoubtedly obtained a colored salt by reacting iodine with gallium since he makes the statement that it would, without doubt, be colorless if it were pure. Whether or not he obtained a pure product is not known; he gives no analytical data to support his description of the salt. We have carried out several preparations of gallium triiodide and in each instance a light yellow salt was obtained even after it had been subjected to several sublimations. Some of the small tubes of the iodide were broken under a starch solution and in no case was a test obtained for the presence of free iodine. However, when this solution was allowed to stand for a few hours, free iodine was found, due to the hydrolysis of the salt and subsequent decomposition of hydriodic acid.

*Other Properties.* Gallium triiodide sublimes readily in vacuo at a temperature as low as  $160^\circ$ . It hydrolyzes readily and is hygroscopic. When it is exposed to the air iodine fumes are liberated and the residue appears to be much darker than the original salt. At higher temperatures decomposition takes place.

#### Gallium Fluoride

When a small quantity of metallic gallium was treated with hydrofluoric acid (50% solution) in a platinum crucible, a white substance, insoluble in an excess of acid and of much greater volume than the original amount of metal, was formed. The reaction was allowed to continue for several hours and the excess of acid was evaporated over steam. The white residue gave tests for fluorine. The details of the preparation and properties of this substance will be described in a later article.

#### Summary

Gallium tribromide and gallium triiodide have been prepared by the direct combination of the elements. Some of the physical properties of these salts have been determined.

*University of Chicago,  
Chicago, Illinois.*

## A SOLID ADDITION COMPOUND OF ACETIC ACID AND STANNIC CHLORIDE

BY ARTHUR W. DAVIDSON

In 1927, Stranathan and Strong,<sup>1</sup> in an investigation of the viscosities, electrical conductivities and specific volumes of acetic acid-stannic chloride solutions, concluded that the extremely high viscosity of some of the solutions and the remarkable deviation of this and other properties from an additive relationship, were to be attributed to the presence in the solution of a compound of the two components, which they suggested might have the composition  $\text{SnCl}_{4.3}\text{CH}_3\text{COOH}$ . An attempt to determine the freezing-point curve of the system was reported as unsuccessful because of the tremendous degree of supercooling encountered in the very viscous mixtures.

Immediately after the appearance of the article referred to, the present writer, being interested in the subject of addition-compound formation in acetic acid solution, prepared about 10 c.c. of a mixture of anhydrous stannic chloride and 99.7% glacial acetic acid in the proportions of one mol of the former substance to three of the latter, and attempted to isolate a solid addition compound by maintaining the solution at  $-33^\circ$  in a bath of liquid ammonia for several hours. No crystallization occurred, however, and the test-tube containing the mixture was stoppered and allowed to stand at room temperature; further examination at intervals showed no change, and the tube was set aside. Recent inspection, after the mixture had stood for over two years altogether, and had not been examined or disturbed for some months, revealed the presence in the bottom of the tube of about 0.5 c.c. of solid, in the form of a compact mass of transparent colorless crystals. Vigorous shaking of the mixture produced no further crystallization, indicating that the solid was probably not of the same composition as the solution. The crystals were separated from the solution by filtration, and were dried by pressing them between porous tiles, with as little exposure to the atmosphere as possible. In this manner there was obtained about 0.35 gram of a white crystalline powder.

This substance was apparently stable in a desiccator, but deliquesced very rapidly in the moist air of the laboratory. It had a decided odor of acetic acid, and dissolved readily in water to give a markedly acid solution, clear at first but gradually acquiring a white turbidity on standing. Qualitative tests showed the presence of stannic and of chloride ions in the solution. These facts left little room for doubt that the substance was an addition compound of stannic chloride and acetic acid.

The amount of substance remaining after these preliminary tests being just about sufficient for a single analysis, a determination of its chlorine con-

<sup>1</sup> Stranathan and Strong: *J. Phys. Chem.*, 31, 1420 (1927).

tent was made. After the tin had been precipitated with hydrogen sulfide, the stannic sulfide filtered off, and the very dilute solution boiled until excess hydrogen sulfide was expelled, the chlorine was precipitated as silver chloride in the usual manner. The result of the analysis was as follows.

Subs., 0.1900 : AgCl, 0.2126. Calcd. for  
 $\text{SnCl}_{4.4}\text{CH}_3\text{COOH}$  : Cl, 28.33%. Found: 27.68%.

While it is to be regretted that the amount of substance available did not permit of a check upon this analysis, it is believed that the evidence presented is sufficient to establish the existence of a solid addition compound of the formula  $\text{SnCl}_{4.4}\text{CH}_3\text{COOH}$ . This, of course, does not preclude the possibility of the presence of other compounds in the solution also.

It should be mentioned here that Fichter and Herszbein<sup>1</sup> have recently reported the preparation of a stannic dichloride diacetate,  $\text{SnCl}_2(\text{CH}_3\text{COO})_2$ , made by adding stannic chloride to an equal quantity of acetic acid containing some acetic anhydride, and distilling off part of the mixture.<sup>2</sup> They suppose that the first step in the reaction is the formation of the addition compound,  $\text{SnCl}_{4.2}\text{CH}_3\text{COOH}$ , which loses hydrogen chloride to give the compound finally obtained; this hypothesis was not verified, however.

In view of the decidedly unusual properties of the system under discussion, a study of its properties from the point of view of the phase rule would be of great interest. It appears from the facts here noted, however, that the extreme slowness with which equilibrium between solid and liquid phases is attained in these mixtures, would offer an almost unsurmountable obstacle to such an investigation.

Summary:—The occurrence of compound formation in solutions of acetic acid and stannic chloride, suspected by several previous authors, has been verified by the isolation from such a solution of a solid addition compound, apparently having the formula  $\text{SnCl}_{4.4}\text{CH}_3\text{COOH}$ .

*Chemical Laboratory,  
University of Kansas,  
Lawrence, Kansas.*

<sup>1</sup> Fichter and Herszbein: *Helv. Chim. Acta*, 11, 431 (1928).

<sup>2</sup> This compound also is described as a white, crystalline, deliquescent solid; unlike the addition compound reported in the present note, however, it is said to fume in the air. The chlorine content calculated for stannic dichloride diacetate is 23.05%.

## PHASE RULE STUDIES ON THE PROTEINS. III\*

BY WILDER D. BANCROFT AND C. E. BARNETT

### Pentavalent Nitrogen in Organic Compounds. II.

In the preceding paper,<sup>1</sup> we discussed the conditions under which compounds containing one nitrogen atom in the molecule will or will not add hydrogen chloride stoichiometrically at ordinary temperature and under atmospheric pressure. In this paper we propose to discuss the corresponding problem when there are two nitrogen atoms in the molecule. It will probably simplify matters if we repeat from the preceding paper the eight generalizations which constitute our working hypothesis.

I. The tendency for a nitrogenous compound to react stoichiometrically with hydrogen chloride is increased when hydrogen is replaced by an alkyl group and is decreased when the hydrogen is replaced by a phenyl group.

II. Introduction of so-called negative radicals, such as O, Cl, Br, NO<sub>2</sub>, etc., decreases the tendency of the nitrogenous compounds to react stoichiometrically with hydrogen chloride. These radicals have most effect when attached directly to the nitrogen.

III. Carbonyl groups attached directly to the nitrogen or an aliphatic ethylene carbon linkage decreases the tendency of the nitrogen to react stoichiometrically with hydrogen chloride. For convenience of discussion we shall call two carbonyl groups attached to nitrogen a diketo linkage, a CO group and a C:C aliphatic group attached to nitrogen a keto-ethylene linkage, and two C:C aliphatic groups attached to nitrogen a di-ethylene linkage. Two keto linkages or one keto and one ethylene linkage will destroy the tendency to add hydrogen chloride unless compensated by the presence of alkyl groups, etc. Since there are not many data at best, we usually mean methyl or ethyl groups when we speak of alkyl groups.

IV. Two or more nitrogens attached to the same carbon atom destroy the tendency to combine stoichiometrically with hydrogen chloride for all but one of the nitrogens, except in so far as this may be compensated by the introduction of alkyl groups.

V. In general, linkage of nitrogen to nitrogen seems to destroy the power of all but one of the nitrogens to combine stoichiometrically with hydrogen chloride, except in so far as this is compensated by the introduction of alkyl groups.

VI. Hydrogen chloride does not add direct to nitrile nitrogen, an isonitrile nitrogen, or a cyanate nitrogen.

\* This work is part of the programme now being carried out at Cornell University under a grant from the Heckscher Foundation for the Advancement of Research established by August Heckscher at Cornell University.

<sup>1</sup> Bancroft and Barnett: *J. Phys. Chem.*, **34**, 753 (1930).

VII. If the nitrogen is already pentavalent through formation of an intramolecular salt, hydrogen chloride can only be taken up stoichiometrically in case it displaces the other acid.

VIII. Hydrogen chloride will add first to the nitrogen with which it will give the lowest dissociation pressure.

#### Substances containing Two Nitrogen Atoms

It was mentioned in the preceding paper that in the ethylene amines the basicity is equal to the number of the nitrogens. The diamines add two molecules of hydrogen chloride, the triamines three, and the tetramines four.<sup>1</sup> Diaminohexane adds two hydrogen chlorides. Lysine has two nitrogens and adds two hydrogen chlorides. Tryptophane has two nitrogens and must add two hydrogen chlorides unless it forms an intramolecular salt, in which case the ester must add two hydrogen chlorides. So far, we have only found a record in the literature of a monochloride and nobody has studied the ester. In regard to the aromatic diamines, Sidgwick<sup>2</sup> says:—

“The aromatic diamines are colourless, crystalline bodies which are much more soluble in water than the aniline bases. They form salts with two equivalents of acids. . . . The orthodiamines are remarkable for their great tendency to form ortho-condensation products; the two nitrogens joining up through the other body with which they react to form a new ring. Thus they combine with acids to form the anhydro-bases, cyclic amidines, or imidazoles:—

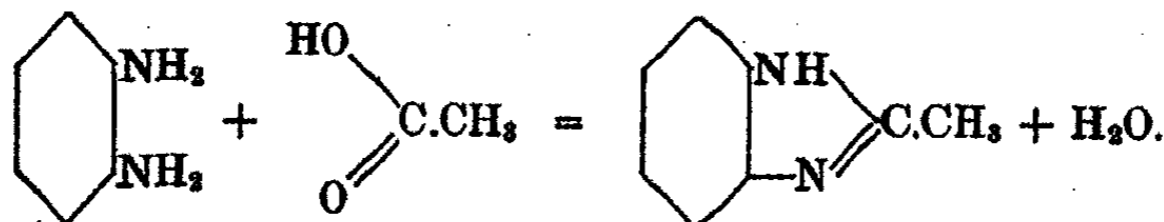

These bodies are strong bases and are thereby distinguished from the true amides, such as  $\text{C}_6\text{H}_4(\text{NHCOCH}_3)_2$ , which are formed with acids by the meta- and para diamines. . . .

“The ortho-diamines form similar ring compounds with nitrous acid, the

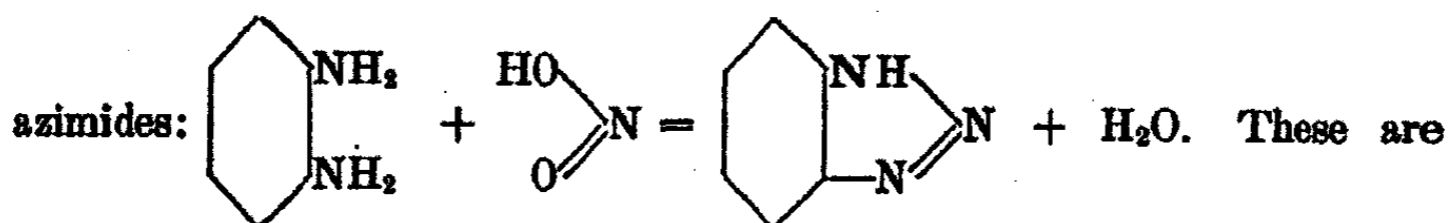

colourless, excessively stable substances, which can be boiled with alkali or heated to a high temperature without decomposition. They are thus sharply distinguished from the diazo-compounds, and more particularly from the

enormously explosive azoimide,  $\text{HN} \begin{array}{c} \diagup \\ \text{N} \\ \diagdown \end{array}$ , which contains the same chain of three nitrogen atoms. This difference also is no doubt due to the strain in the ring.”

<sup>1</sup> Laubenheimer: “Die Grundzüge der organischen Chemie,” 298 (1884).

<sup>2</sup> Sidgwick: “The Organic Chemistry of Nitrogen,” 70 (1910).

The aromatic diamines combine stoichiometrically with two hydrogen chlorides, because the two nitrogens are not attached to the same carbon atom. In the anhydro-bases the two nitrogens are attached to the same carbon atom and consequently these bases add only one hydrogen chloride. For the same reason the aliphatic and aromatic amidines<sup>1</sup> only add one hydrogen chloride.

"The [aliphatic] amides are strong, monacid bases, which form stable salts. The hydrochlorides generally crystallize well and are readily soluble in water and alcohol. The free amidines show an alkaline reaction, are very instable and decompose readily into ammonia and the corresponding acid."

"The phenyl amidines of the fatty acids are formed from aniline or the anilides by any one of a large number of reactions. One of the best is heating anilides with aniline hydrochloride.

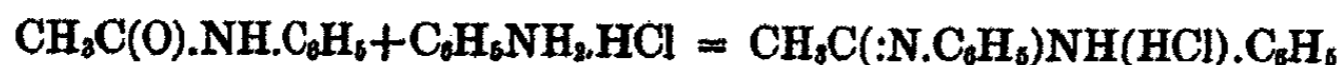

They are colorless compounds which crystallize readily. They dissolve in dilute acids to form salts. The salts contain one molecule hydrogen chloride per molecule amidine."

In the three isomeric amido-benzylamines,  $\text{C}_6\text{H}_4(\text{NH}_2)\cdot\text{CH}_2\text{NH}_2$ , the two amino groups are not attached to the same carbon atom and consequently they add two hydrogen chlorides.<sup>2</sup> "They are readily soluble in water, react alkaline, and take up carbon dioxide from the air. The primary hydrochlorides,  $\text{C}_7\text{H}_9(\text{NH}_2)_2\cdot\text{HCl}$ , react neutral, while the secondary hydrochlorides,  $\text{C}_7\text{H}_9(\text{NH}_2)_2\cdot 2\text{HCl}$ , redden litmus."

Sidgwick<sup>3</sup> says that diimine,  $\text{C}_6\text{H}_4(:\text{NH})_2$ , is "a colorless, crystalline substance. . . . It is not acidic, but weakly basic, forming a colourless hydrochloride." It is easy to see why this compound should add one hydrogen chloride, but it is not clear why it should not add two. If one writes the formula with the two nitrogens connected, as we used to do in the case of quinone, the experimental result follows at once. Whether that is permissible is for the organic chemist to decide.

Benzenyl amidine,  $\text{C}_6\text{H}_4\cdot\text{C}(:\text{NH})\text{NH}_2$ , only adds one hydrogen chloride because the two nitrogens are attached to the same carbon. On the other

hand glycyl glycine adds two hydrogen chlorides. Quinazoline,  $\text{C}_6\text{H}_4\text{-N} \begin{array}{l} \text{CH:N} \\ \text{CH} \end{array}$ , adds one hydrogen chloride because the two nitrogens are attached to the same carbon atom. On the other hand Hantzsch<sup>4</sup> reports on a compound,

$\text{C}_6\text{H}_5 \setminus$   
 $\text{CH}_3\text{OC}_6\text{H}_4\cdot\text{C}:\text{N}\cdot\text{C}_6\text{H}_4\cdot\text{N}:(\text{CH}_3)_2$ , which is said to give one hydrochloride decomposed by water, whereas it should obviously take up two hydrogen chlorides.

<sup>1</sup> Meyer and Jacobson: "Handbuch der organischen Chemie," 1, 377 (1893); 2, 193 (1902).

<sup>2</sup> Meyer and Jacobson: "Handbuch der organischen Chemie," 2, 243 (1902).

<sup>3</sup> "The Organic Chemistry of Nitrogen," 73 (1910).

<sup>4</sup> Ber., 26, 926 (1923).

Hydrazine adds two hydrogen chlorides. We do not have to predict this because hydrazine is not an organic compound. Substituting alkyl groups for the hydrogens should make the compound more strongly basic, while substituting a phenyl group should give a weaker base. This is exactly what happens. Ethyl and dimethyl hydrazines<sup>1</sup> add two hydrogen chlorides, while phenyl hydrazine adds but one.

Sidgwick<sup>2</sup> says: "The primary alkyl hydrazines are very hygroscopic, strongly basic liquids. The secondary alkyl hydrazines, like the primary, are strongly basic, hygroscopic liquids, which are easily soluble in water. Mercuric oxide converts them into tetrazones, such as  $\text{Et}_2\text{N.N:N.NEt}_2$ , which are strongly basic liquids. . . .

"The primary and secondary aromatic hydrazines are decided non-acid bases, forming salts with mineral and some organic acids. Unlike the primary fatty hydrazines they will not form salts with two equivalents of acid, but only with one. Secondary aromatic hydrazines,<sup>3</sup> such as  $\phi_2\text{N.NH}_2$  will form salts with one equivalent of acid, but these are partially decomposed by water. This is like the behaviour of the secondary aromatic amines, and is a sign of the negative character of the phenyl group. It is practically certain that it is only the  $\text{NH}_2$  group which takes part in the formation of these salts. On the other hand the hydrogen of the  $\text{NH}$  group in phenyl hydrazine can be replaced by an alkali metal. . . .

"Tetraphenyl hydrazine was first obtained<sup>4</sup> by the action of iodine on the sodium derivatives of the diphenylamine,  $\phi_2\text{N.Na}$ ; but it and its analogues can be prepared more simply<sup>5</sup> by the oxidation of the diaryl amines with lead dioxide or potassium permanganate.

"These bodies are remarkable for giving brilliant colours with mineral acids; in fact it is to the production of tetraphenyl hydrazine that the blue colour found in the diphenylamine test for nitric acid is due. These colours do not depend, as was at first supposed, on the splitting of the molecule between the two nitrogens, since under proper conditions the hydrazine can be recovered unchanged. The coloured bodies are therefore coloured salts of the colourless hydrazines. Similar coloured compounds (not double salts) are formed by the addition of the halides of phosphorus, tin, iron, aluminum, and zinc. To account for this colour Wieland<sup>6</sup> suggests that they contain a quinoid ring, and are in fact quinol derivatives: for example, the body obtained from tetra-tolyl hydrazine and hydrochloric acid may have the formula:—

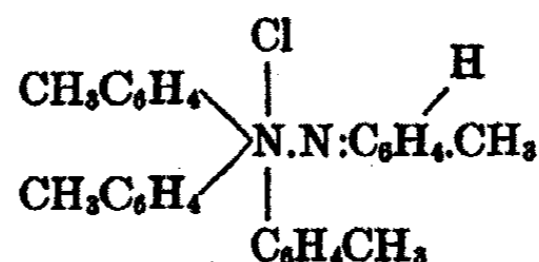

<sup>1</sup> Meyer and Jacobson: "Lehrbuch der organischen Chemie," 1, 249 (1893).

<sup>2</sup> "The Organic Chemistry of Nitrogen," 241, 243, 245 (1910).

<sup>3</sup> [Sidgwick uses  $\phi$  to denote a phenyl group].

<sup>4</sup> Chattaway and Engle: J. Chem. Soc., 67, 1090 (1895).

<sup>5</sup> Wieland and Gambarjan: Ber., 39, 1499 (1906).

<sup>6</sup> Ber., 40, 4260 (1907).



At first this seems impossible, since the quinols have no colour. But quinone diimine,  $\text{HN}:\text{C}_6\text{H}_4:\text{NH}$ , is itself colourless, while its derivatives of the type

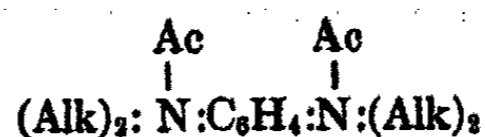

in which the nitrogen has become pentad, and has no hydrogen attached to it, are brilliantly coloured; and we may well suppose that a similar change would produce a coloured compound from a colourless quinol."

Emil Fischer<sup>1</sup> found that with an excess of concentrated hydrochloric acid ethyl hydrazine crystallized with two hydrogen chlorides. On recrystallization from water or on heating to  $110^\circ$ , half the acid went off, leaving the compound  $\text{C}_2\text{H}_5\text{NH.NH}_2.\text{HCl}$ . No dissociation pressures were determined; but it is evident that there is quite a difference between the two and that the pressure-concentration curve would have two clearly-marked flats. Renouf<sup>2</sup> prepared both hydrochlorides of dimethyl hydrazine.

In the case of the unsymmetrical dimethyl hydrazine, the first hydrogen chloride must add to the more basic nitrogen, to the one to which the two methyls are attached, forming  $(\text{CH}_2)_2\text{N}(\text{HCl}).\text{NH}_2$ . While there is no direct proof of this, we can prove it indirectly by considering the addition of ethyl chloride to unsymmetrical phenyl ethyl hydrazine. We know<sup>3</sup> that this forms  $\text{C}_6\text{H}_5(\text{C}_2\text{H}_5)_2.\text{HCl}.\text{NH}_2$ , because it gives diethyl aniline on reduction.

The symmetrical dimethyl hydrazine<sup>4</sup> also adds two hydrogen chlorides, obviously one to each nitrogen.

According to Curtius,<sup>5</sup> benzyl hydrazine,  $\text{C}_6\text{H}_5\text{CH}_2\text{NH.NH}_2$ , adds on one hydrogen chloride. This must be pretty nearly a border line case. Asymmetrical monobenzoyl phenyl hydrazine adds one hydrogen chloride;<sup>6</sup> but is a weak base, the salt being decomposed partially by water. Nothing is said about any hydrochloride of dibenzoyl phenyl hydrazine. Tetraphenyl hydrazine<sup>7</sup> is decomposed by dry hydrogen chloride dissolved in dry ether, so one cannot be sure whether the two form an instable stoichiometric compound or not. It is of course possible that tetraphenyl hydrazine might be more stable in the presence of dry hydrogen chloride and in the absence of ether.

Acetyl hydrazine undoubtedly adds hydrogen chloride. Michaelis and Schlundt<sup>8</sup> make no mention as to diacetyl hydrazine and hydrogen chloride, while Stolle<sup>9</sup> reports that both triacetyl hydrazine and tetrachloride hydrazine

<sup>1</sup> Ann., 199, 291 (1879).

<sup>2</sup> Ber., 13, 2171 (1880).

<sup>3</sup> Meyer and Jacobson: "Handbuch der organischen Chemie," 2, 320 (1902).

<sup>4</sup> Thiele: Ber., 42, 2575 (1907).

<sup>5</sup> J. prakt. Chem., (2) 62, 95 (1899).

<sup>6</sup> Michaelis and Schmidt: Ber., 20, 43 (1887).

<sup>7</sup> Wieland and Gambarjan: Ber., 39, 1501 (1906).

<sup>8</sup> Ber., 20, 43 (1887); Widman: 26, 945 (1893); 27, 2904 (1894); Hofmann and Marburg: Ann., 305, 220 (1899).

<sup>9</sup> J. prakt. Chem., (2) 69, 145 (1904).

react acid and split off acetic acid. These compounds should be studied again to find just where the dividing line is and whether it could be moved one way or the other by introduction of a phenyl or a methyl group.

Sidgwick<sup>1</sup> says that "the hydrazo compounds are neither basic nor acidic, the amino group being neutralized by the negative phenyl." While we have not yet checked this, it cannot be right because azobenzene adds on hydrogen chloride stoichiometrically and hydrazobenzene must be more basic because of the extra hydrogens. In so far as hydrazobenzene might be converted into benzidine by hydrogen chloride, there would be some experimental difficulties; but we rather doubt their being serious. Of course hydrazobenzene is a symmetrical hydrazine and as such must add hydrogen chloride.

Benzidine of course adds two hydrogen chlorides and so does benzidine sulphone,<sup>2</sup>  $\text{SO}_2$   $\begin{array}{l} \diagup \text{C}_6\text{H}_5\text{-NH}_2 \\ \diagdown \text{C}_6\text{H}_5\text{-NH}_2 \end{array}$ . Addition of sulphonic acid groups decreases

the strength of the base to such an extent that benzidine monosulphonic acid apparently adds only one hydrogen chloride, while the benzidine di-, tri-, and tetra-sulphonic acids apparently add none.

One would rather like to see experiments made with hydrazo-triphenylmethane.<sup>3</sup> "Hydrazo-triphenyl-methane,  $\varphi_3\text{C.NH.HN.C}\varphi_3$ , like so many other compounds containing this radical, has a very peculiar behavior.<sup>4</sup> It is a comparatively stable substance, and is not oxidized at all by the air or by silver oxide. Stronger oxidizing agents, such as potassium permanganate or chromic acid, remove the hydrogen of the hydrazo groups; but the azo-compound,  $\varphi_3\text{C.N:N.C}\varphi_3$ , which we must suppose to be formed, breaks up at once into nitrogen and triphenyl-methyl,  $\varphi_3\text{C}$ , which appears as its peroxide,  $\varphi_3\text{C.O.O.C}\varphi_3$ .

"Thus the relations which hold with the simplest aromatic derivatives (such as hydrazo-benzene) are here reversed. The hydrazo-compound is much more stable and the azo-body infinitely less so. Wieland expresses this by saying that the weak affinity of the triphenyl-methyl group makes the attachment of the hydrogen to the nitrogen in the hydrazo-compound much weaker than in hydrazo-benzene, while it is unable to hold the azo-group at all."

It is rather curious about azobenzene. It was believed by van't Hoff that azobenzene did not add hydrogen chloride at all. Meyer and Jacobson<sup>5</sup> say that "azobenzene combines with benzene, bromine, hydrogen chloride, and hydrogen bromide to form addition compounds which decompose readily." On the other hand, Rosecoe and Schorlemmer<sup>6</sup> give a good deal of interesting detail.

<sup>1</sup> "The Organic Chemistry of Nitrogen," 254 (1910).

<sup>2</sup> Griess and Duisberg: Ber., 22, 2459 (1889).

<sup>3</sup> Sidgwick: "The Organic Chemistry of Nitrogen," 255 (1910).

<sup>4</sup> Wieland: Ber., 42, 1902 (1909).

<sup>5</sup> "Handbuch der organischen Chemie," 2, 256 (1902).

<sup>6</sup> "A Treatise on Chemistry," 3 III, 291 (1887).

"Azobenzene crystallizes from alcohol or petroleum spirit in yellowish-red plates which melt at 68° and have faint odour of roses. It boils at 293° and its vapour has a sp.gr. of 6.5. On the spontaneous evaporation of its solution in benzene, the compound  $C_{12}H_{10}N_2 + C_6H_6$  separates out in long, thick, yellowish-red prisms which effloresce in the air. If hydrochloric acid gas be passed into a solution of azobenzene in carbon disulphide, a yellow crystalline compound,  $(C_{12}H_{10}N_2)_2 \cdot 3HCl$ , is formed; the analogous hydro-

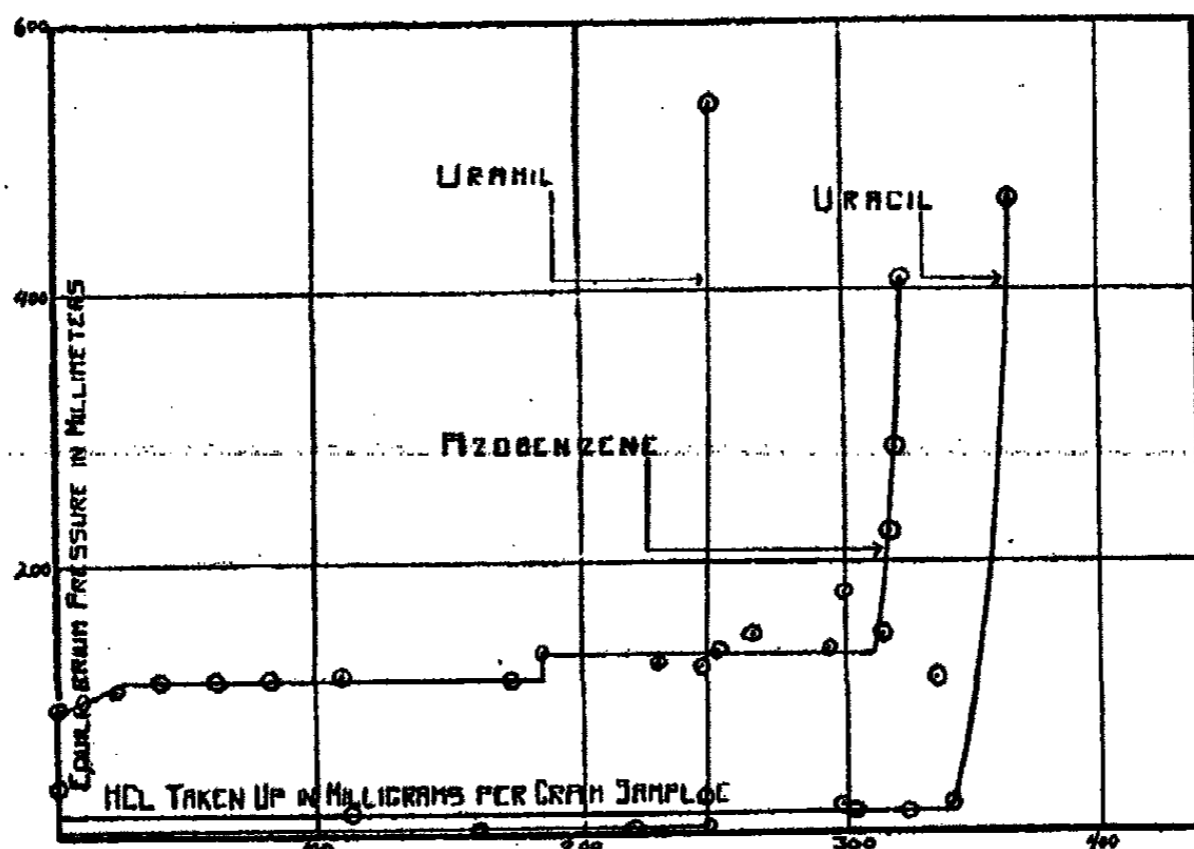
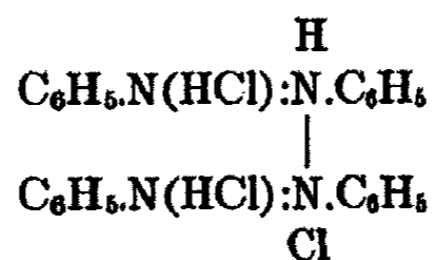

FIG. 1

bromic acid compound is a carmine-red crystalline mass. Bromine, added gradually to a solution of azobenzene in chloroform, forms the addition product,  $C_{12}H_{10}N_2 \cdot Br_6$ , which separates in large dark-red prisms. All these compounds decompose in the air leaving a residue of azobenzene."

Our generalizations lead to the assumption that azobenzene should take up one hydrogen chloride but did not call for more. Consequently, we checked up to see whether Roscoe and Schorlemmer were right. They were, as Fig. 1 shows. It was a simple matter to find a way out of the difficulty. Our generalizations call for the addition of two hydrogen chlorides and not three to the nitrogens in two azobenzenes; but we are dealing only with direct addition of hydrogen chloride to nitrogen. If we write the formula,



the third hydrogen chloride does not add direct to nitrogen and we are no more concerned with it than we are with the addition of hydrogen chloride to hydrogen cyanide to form  $HC(Cl) : NH$ . As matters stand, the azobenzene case is a very striking confirmation of our point of view. It was simpler for

the hydrogen chloride to dissociate and for the azobenzene to polymerize than for a second hydrogen chloride to add to the second nitrogen. It is relatively easy to make a compound  $(C_{12}H_{10}N_2)_{2,3}HCl$ . It was not possible under our limitations to make the compound  $C_{12}H_{10}N_{2,2}HCl$ .

In the diazonium salts, we already have a pentavalent nitrogen and there is no reason why these compounds should add on another hydrogen chloride, and they do not.<sup>1</sup>

"The mineral acid salts of diazo-benzene are colourless, crystalline solids, very easily soluble in water, less in alcohol, and scarcely at all in ether. They have the full character of salts, being highly ionized and not hydrolyzed, as is shown by their having a neutral reaction when pure. . . . The haloid salts have a characteristic power of taking up two more atoms of halogen to form perhalides, such as  $N_2.Br_2$ , which are analogous to the alkaline perhalides, like  $KI_3$ . . . . The  $N_2$  group, though normally a strong base, is also capable of behaving as a weak acid. If a concentrated aqueous solution of diazobenzene chloride is poured into a large excess of very concentrated potash, potassium benzene diazotate,  $\phi N_2OK$ , separates."

Marckwald<sup>2</sup> reports that the alpha and gamma amido-pyridines do not react with dilute nitrous acid, which should mean that there are no  $NH_2$  groups in the molecule. They do react smoothly in sulphuric acid solution. We can write two formulas which will fit the problem of the alpha amido-pyridine.

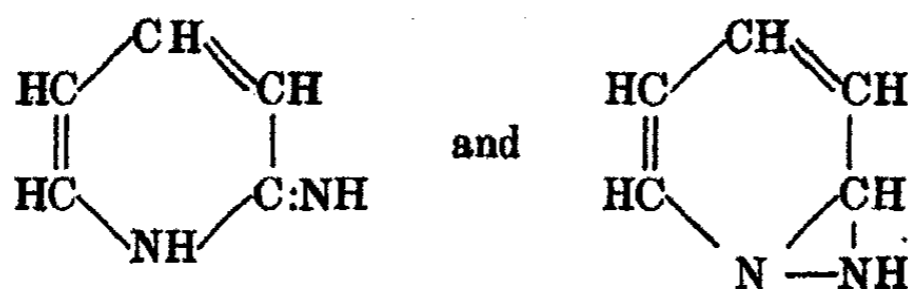

Of these two, the first one is the one that we should normally accept. Both account for no nitrogen being given off unless the sulphuric acid is concentrated enough to restore the normal structure. Similar formulas may be written for the gamma amido-pyridines

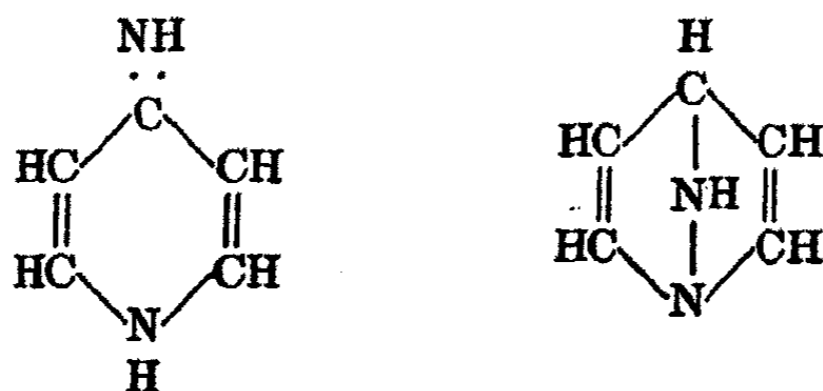

Here again we should usually take the first one as the more probable. Marckwald, however reports that the alpha amido-pyridine is strongly alkaline and combines stoichiometrically with one hydrogen chloride which goes on the

<sup>1</sup> Sidgwick: "The Organic Chemistry of Nitrogen," 259 (1910).

<sup>2</sup> Ber., 27, 1317 (1894).

pyridine nitrogen. This could happen under either of the formulas given above. Unfortunately Marckwald does not state how many hydrogen chlorides the gamma amido-pyridines take up. If they take up two, the first formula is the right one in principle. If they only take up one hydrogen chloride, we must postulate some such formula as the second one, in which case we should probably adopt the second formula for the alpha amido-pyridines.

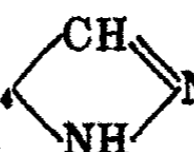
Meyer and Jacobson<sup>1</sup> says that indazol,  $C_6H_4$   is a monacid base.

Since the two nitrogens are linked together, this is what we should have predicted. The case of 2-phenyl indazol is not so good. The formula is written

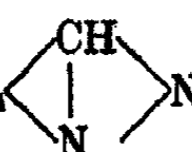
$C_6H_4$    $N.C_6H_5$ , and the compound should add one hydrogen chloride.

So far as we can learn, this hydrochloride has not yet been prepared, although it seems to be postulated by the statement that the substance dissolves in concentrated mineral acids. It is pretty certain that a hydrochloride will be prepared as soon as somebody sets about the task in a little less crude fashion.

The formula for urea is usually written  $H_2N.C(O).NH_2$ . According to Laubenheimer,<sup>1</sup> "urea combines with the stronger acids (not carbonic acid) to form salts which react acid. Its weakly basic properties are destroyed when it has combined with one equivalent of acid. Of practical importance for the preparation of urea from urine is the nitrate,  $H_2N.C(O).NH_2.HNO_3$ , which is only sparingly soluble in water and still less soluble in nitric acid and alcohol." We have confirmed the monacid character, Fig. 2.

Since the two nitrogens are attached to the same carbon, urea should be a monacid base, as it is. On the other hand, there is a good deal of evidence to show that the constitution is not the one usually given in textbooks. As this is the first of quite a number of cases which we shall encounter, it may be well to discuss it in some detail.

Emil A. Werner<sup>2</sup> considers that the true formula is the cyclic one,

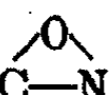
  $HN:C-NH_2$ . One strong argument in favor of this view is to be found in the reaction between urea and nitrous acid (pp. 49-58).

"A careful quantitative study of the behaviour of urea towards nitrous acid was made by the writer<sup>3</sup> in 1917. The results have supplied convincing evidence in support of the cyclic formula of urea. The following facts were clearly established:—

1. Urea and pure nitrous acid in aqueous solution do not interact.
2. The presence of a strong acid (hydrochloric or nitric) quickly promotes a brisk interaction even in dilute solutions and the reaction is then completed in a relatively short time.

<sup>1</sup> "Lehrbuch der organischen Chemie," 2 III, 422, 428, 429 (1920).

<sup>2</sup> "The Chemistry of Urea" (1923).

<sup>3</sup> J. Chem. Soc., 111, 863 (1917).

3. The presence of a weak acid, such as acetic acid, does not promote an interaction, unless the concentration is abnormally high, and even then the velocity of the reaction is essentially slow.

4. The volume of nitrogen evolved is not a direct measure of the amount of urea decomposed, calculated on the basis of the equation,  $\text{CON}_2\text{H}_4 + 2\text{HNO}_2 = \text{CO}_2 + 2\text{N}_2 + 3\text{H}_2\text{O}$ ; the quantity decomposed is always much greater than that indicated by the evolved nitrogen.

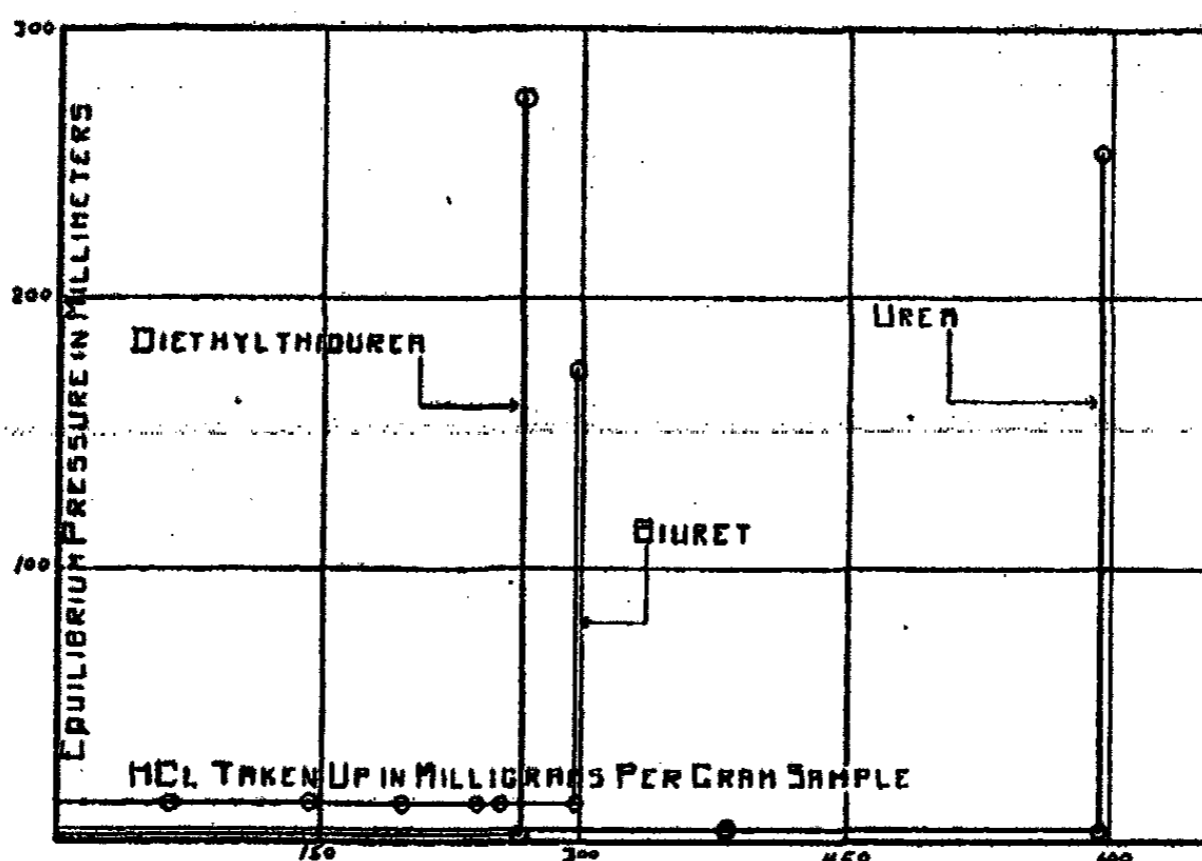

FIG. 2

5. Only when urea is present in considerable excess is the volume of nitrogen evolved an approximately true estimate of the volume of nitrous acid decomposed.

6. The volume ratio of carbon dioxide to nitrogen (1:2) required by the equation is never obtained; the proportion of carbon dioxide is always much higher; moreover, the composition of the gas is liable to much variation with small changes in concentration.

"It is obvious that, so far as the usual explanation of this reaction is concerned, all these facts stand out as anomalies for which the ordinary equation offers no explanation. Now, as anomalies in such a reaction can have no reality; their apparent existence is the natural consequence of an erroneous conception of the change, and when the true constitution of urea is considered, they appear as normal phenomena which reveal the true mechanism of the interaction.

"The experimental evidence has shown that the progress of the interaction of urea and nitrous acid takes place in the following manner. The decomposition, by nitrous acid, of aliphatic compounds containing an amino-group is dependent upon the readiness with which this group is oxidised, thus:—

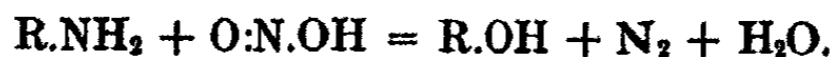

"Hence, since *pure* nitrous acid in aqueous solution does not react with urea, the amino-group cannot be present.

"The condition necessary for attack is brought about by the production of a salt of urea on the addition of a sufficiently strong acid, thus—

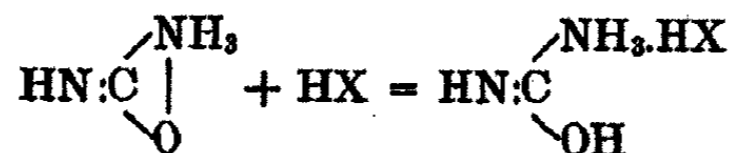

The first stage of the reaction then takes place, in accordance with the equation<sup>1</sup>

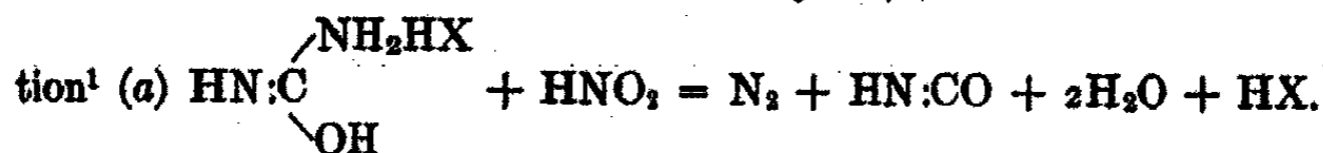

The cyanic acid is decomposed in two ways as fast as it is generated. It is hydrolysed thus—



and directly attacked by nitrous acid, according to the equation

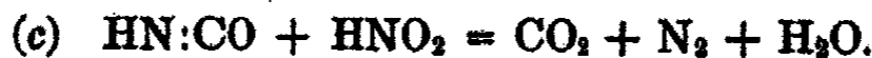

Both of these decompositions proceed simultaneously with the primary reaction (a), but the relative proportions in which they take place can be varied at will, within certain limits, by adopting suitable conditions which will be referred to presently. . . .

"It will be seen now that when urea (in the form of a salt) and nitrous acid interact, a certain proportion of nitrogen from the urea is always fixed as an ammonium salt, and herein lies the fallacy of the reaction, so far as the estimation of urea is concerned."

"Ray, Dey and Ghosh (1917) have shown that at 0° the most concentrated solution of nitrous acid stable for only a short time was approximately N/5.5, whilst at the ordinary temperature a solution of the acid at N/30 showed signs of decomposition after about an hour. It is this decomposition of nitrous acid which is responsible for the fact that a solution of, say, HNO<sub>2</sub> = N/6 can attack urea slowly: the generation of nitric acid gradually brings about the required condition.

"In order to prove that urea is not attacked by pure nitrous acid alone, it is necessary that the concentration of the latter should not be greater than N/30. Under such condition, the solution being protected from the light which promotes the decomposition of nitrous acid, no interaction was found to take place even after three days; yet on the addition of two drops of hydrochloric acid solution a brisk reaction was quickly promoted, and even at this low concentration of nitrous acid was almost completed at the end of half an hour."

<sup>1</sup> No doubt this decomposition originates through the medium of diazotisation,—

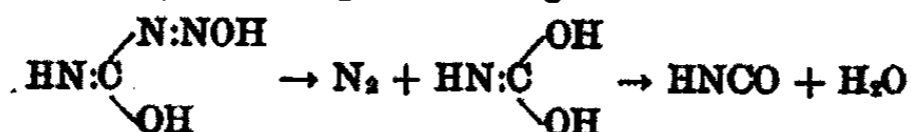

"It was noticed by Bonner and Bishop<sup>1</sup> and later by Ráy, Dey and Ghosh<sup>2</sup> that a dilute solution of nitrous acid and urea sometimes failed to react. The latter observers found that the addition of sulphuric acid was necessary to promote and complete a reaction. In both cases, it was remarked that there was no apparent reason for this result. The explanation is now obvious. The writer maintains that nitrous acid is a thoroughly reliable reagent for the detection of the amino-group, provided the compound under examination does not contain another group readily attacked by the same agent. Thiourea furnishes an interesting case in point.

"According to the views of the writer, the compound can exist in solution as  $\text{HN:C(SH).NH}_2$ ; it is readily decomposed by pure nitrous acid with production of  $\text{HSCN}$ , nitrogen, and water. Since the sulphur remains in its original state of combination, the attack is by way of the amino-group. On the other hand, when nitrous acid is added to a salt of thiourea,  $\text{HN:C(SH).NH}_2.\text{HX}$ , the amino-group is to a certain extent 'protected' by its union with  $\text{HX}$ , and in this case the more vulnerable  $\text{SH}$  group is oxidised first, i.e., hydrogen is removed from two molecules of the thiourea salt with production of the salt  $\text{HX.H}_2\text{N.C(NH).S.S.C(NH).NH}_2.\text{HX}$ . The further addition of nitrous acid then attacks the amino-group with evolution of nitrogen."

As we understand Werner, his idea would be that if we had carbimide it would change in two stages to the cyclic form:



We are emphasizing this now because we shall need it later when we take up the behaviour of biuret.

The nitrous acid method referred to is the one developed by D. D. Van Slyke.<sup>3</sup> "It has long been known that aliphatic amino groups react with nitrous acid according to the equation

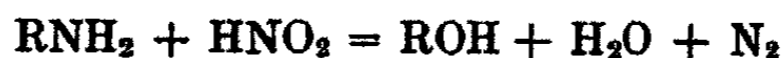

Since the nitrogen in gaseous form leaves the system, the reaction should theoretically proceed quantitatively from left to right, as is actually the case. Sachs and Kormann<sup>4</sup> originally made this reaction the basis of a method of a method for quantitative determination of amino groups. Since then a number of other methods<sup>5</sup> based on the same reaction have appeared, none of which, however, appears to have satisfied the demands of simplicity, rapidity, and accuracy required to make the reaction available for general use in chemistry and biology. The method described in the following pages appears to meet these requirements. The complete determination of nitrogen in amino-acids can be finished in a few minutes, and the error kept within  $\pm 0.05$  mg. of nitrogen.

<sup>1</sup> J. Ind. Eng. Chem., 5, 134 (1913).

<sup>2</sup> J. Chem. Soc., 111, 413 (1917).

<sup>3</sup> J. Biol. Chem., 9, 185 (1911).

<sup>4</sup> Z. anal. Chem., 14, 380 (1875).

<sup>5</sup> Koenig: "Chemie der menschlichen Nahrungs- und Genussmittel," 4th. Ed., 3, 274.



"Nitrous acid in solution decomposes spontaneously with formation of nitric oxide:



This reaction is utilized in displacing all the air in the apparatus with nitric oxide. The amino solution is then introduced, evolution of nitrogen mixed with nitric oxide resulting. The nitric oxide is absorbed by alkaline permanganate solution, and the pure nitrogen measured in the special gas burette. . . .

"Amino-groups in the  $\alpha$ -position to carboxyl, as in the natural amino-acids, react quantitatively in five minutes at  $20^\circ$ . The group in lysin requires one-half hour to react completely, lysin being the only natural amino-acid which requires more than five minutes. Ammonia and methylamine require 1.5-2 hours to react quantitatively. Urea requires eight hours. In one hour it gives off fifty percent of its nitrogen, and the reaction rate follows the monomolecular equation: Amino groups in purines and pyrimidines require 2-5 hours at  $20^\circ$ . . . .

"All the amino-acids react quantitatively with their  $\alpha$ -amino groups. Lysin reacts with its  $\omega$ -amino group also, but less rapidly. The guanidin group in guanidin, creatin, and arginin does not react at all, nor does the nitrogen of the imidazol ring in histidin, the indol ring in tryptophan, or the pyrrolidine ring in prolin and oxyprolin. Summarizing the amino acid result: *every known amino-acid obtained from proteins by acid hydrolysis reacts quantitatively with one and only one nitrogen atom, except lysin, which reacts with two, and prolin and oxyprolin, which do not react at all. All the amino-acids react with all of their nitrogen, except tryptophan, which reacts with one-half, histidin with one-third, arginin with one-fourth, and prolin and oxyprolin with none.*

"The dipeptids leucyl-leucin and leucyl-glycin react with only their free primary amino-groups. The amino nitrogen bound in the  $-\text{CO}-\text{NH}-$ peptid linking does not react. Glycin anhydride, in which both nitrogens are in the amino-peptid linkings, gives off no nitrogen at all when treated with nitrous acid.

"The proteins, egg albumin and edestin, react, as might be expected from Fischer's peptid theory of structure, with only a trace of their nitrogen [about three percent], nearly all of the latter being bound in the peptid linkings of the protein molecule. The proportion of free amino groups is twice as great in the primary albumoses, [over six percent], and still greater in the deutero [ten to thirteen percent]. The smaller the molecule, the greater the proportion of free amino nitrogen, as is already indicated by the results with the peptids.

"From the results of Levites<sup>1</sup> and Skraup,<sup>2</sup> who found that no lysin could be obtained on hydrolysis of deaminized proteins, it appears probable that a large part of the free amino nitrogen in the native proteins is in the lysin radi-

<sup>1</sup> Biochem. Z., 20, 224 (1909).

<sup>2</sup> Ann., 351, 379 (1906).

ole, of which presumably only one of the two amino groups is bound in peptid linking.

"Asparagin, as Sachs and Kormann found, reacts only with its  $\alpha$ -amino group. It does not react appreciably with the acid-amid nitrogen even when the reaction is prolonged for hours. From this it appears that the conclusions of Schiff<sup>1</sup> are not final. He found that deaminizing proteins with nitrous acid did not remove the 'amid' nitrogen, and concludes that this nitrogen can not originate from  $-\text{CONH}_2$  groups in the molecule. As the acid amid nitrogen is not readily decomposed into free nitrogen by nitrous acid, Schiff's results do not prove the point. The work of Osborne, Leavenworth and Brautlecht<sup>2</sup> makes it very probable that the amid nitrogen does exist in the protein molecule in acid amid combination with the aspartic and glutamic acid radicals.

"The purine and pyrimidine derivatives react normally, except guanosin. Although the purity of this substance was undoubted, as controlled by independent analyses, it regularly yielded about 1-1/4 instead of 1 molecule of nitrogen. Apparently the purine ring is partially broken when nitrous acid acts on guanosin. Guanin itself is so insoluble that it precipitates in the reaction mixture, and only a fraction of it reacts in several hours.

"Glycyl-glycin, unlike the other peptids, reacts not only with its free primary amino nitrogen, but also, as Fischer and Koelker<sup>3</sup> have shown, with a part of the secondary nitrogen in the peptid linking. This is doubtless connected with the peculiar behavior of glycocoll itself when treated with nitrous acid. It gives off not only nitrogen, but carbon dioxide and traces of some other gas, which is not absorbed by permanganate, indicating that decompositions deeper than the deamination occur. . . .

"The course of the glycyl-glycin reaction is, however, what would be expected in case the diazo compound first formed decomposes in two ways, a portion of the glycyl radical disintegrating completely, while another portion follows the normal reaction course, with formation of stable glycollyl-glycin. The complete disintegration of a portion of the glycocoll-diazo compound explains the origin of carbon dioxide from both glycocoll and glycyl-glycin. It also explains the fact that the reaction with glycyl-glycin takes approximately twice as long for completion as that with the amino-acids. The reaction in this case consists of two deaminations, one following the other, and should therefore cover twice the time of one deamination. The glycollyl radical being stable, the part of the molecule deaminized in the normal manner is not further decomposed, and a portion of the secondary nitrogen (60 percent in this case) remains stable. The same reaction occurs to a less extent with seryl peptids. When the glycyl group is in the molecule at any place except the end of the chain the peptid reacts only normally, as shown by leucyl-glycin and glycin anhydrid. . . .

<sup>1</sup> Ber., 29, 1354 (1896).

<sup>2</sup> Am. J. Physiol., 23, 180 (1908).

<sup>3</sup> Ann., 340, 177, (1905).

"As Emil Fischer and his pupils have shown, the proteins are to be regarded as chains of amino-acids linked together as in peptids. By hydrolysis the  $-\text{CO}-\text{NH}-$  links are split, with formation of a free  $-\text{NH}_2$  group from each link. Consequently, in a partially hydrolyzed protein, the ratio of the amino nitrogen already set free to that freed by complete hydrolysis is a measure of the proportion of the peptid linkings broken, or the extent of the hydrolysis. Also the rate at which the amino groups are freed is the velocity of the hydrolysis.

"As already shown, the peptid-bound nitrogen, in peptides containing the glycol group at the end of the chain, can be attached to some extent by nitrous acid; but few of the known proteins contain enough glycol to form such peptides in sufficient amount to influence the determinations appreciably."

Van Slyke was interested primarily in developing a method for analyzing proteins and consequently he was not especially interested in the effect of small or varying amounts of acid. This point has been studied in some detail by Plimmer,<sup>1</sup> who has been able to draw some very interesting conclusions. "These experiments were therefore undertaken to find out the conditions under which the amides, guanidine, and other amino-compounds react with nitrous acid and to reconcile the various discrepancies in the previous results. Some other amino-compounds besides the above-mentioned were also tested. . . .

"The experiments with the above amides show clearly that these do not give off an appreciable quantity of nitrogen with nitrous acid in the presence of acetic acid in twenty-four hours, and are thus sharply distinguished from the simple amino-acids, which were shown by Van Slyke to react rapidly and completely in from five to thirty minutes. The difference in behaviour is clearly shown with asparagine; only one amino group reacts in a period of twenty-three hours under these conditions. On introducing hydrochloric acid to the reaction mixture, complete reaction of the amide group did not occur until 5 c.c. of concentrated acid had been added. This amount of acid gave a concentration of approximately 2N HCl. In the case of asparagine, the whole of its nitrogen was then evolved as gas.

"The formation of nitrogen in the presence of hydrochloric acid is not due to hydrolysis of the amide. Experiments were made to test this possibility by allowing 20 c.c. of the amide solution to stand for twenty-four hours with 6 c.c. concentrated hydrochloric acid. The solution was then rendered alkaline with sodium carbonate, and any amounts produced estimated by the aëration method of Folin. Acetamide gave 26.3, propionamide 26.3, asparagine, 4.9%. Formamide was apparently completely hydrolysed with the formation of 96.2% of ammonia.

"If the reaction of amino-acids with nitrous acid in acetic acid solution is taken as an indication of the presence of a primary amino-group, the difference in the behaviour of the amides should be represented by giving amides

<sup>1</sup> J. Chem. Soc., 127, 2651 (1925).

the alternative formula,  $R.C(OH):NH$ , which may be regarded as being converted in the presence of mineral acid into the more usual formula,  $R.CO.NH_2$ , which shows the presence of an  $NH_2$  group. This alternative formula is supported by the formation of unstable salts of amides, which are decomposed by water.

"Van Slyke has stated that urea reacted slowly with nitrous acid in the presence of acetic acid. These results show that at low temperatures (from  $10^\circ$  to  $12^\circ$ ) the reaction is not complete, but that complete decomposition occurs at  $18^\circ$  to  $20^\circ$ . Werner, under different experimental conditions, did not observe complete reaction, and attributed the incompleteness to the formation of ammonium salts. As seen from the experiment with ammonium acetate, it is completely decomposed in twenty-four hours. The difference in the results seems to be due to the length of time of the reaction. As urea was decomposed in the presence of acetic acid, no experiments were made in the presence of hydrochloric acid. On comparing these results with those of amides, it appears that urea possesses the alternative formula

$HN:C-NH_2$ , which changes in presence of acid to  $HN:C(OH).NH_2$ , as proposed by Werner. The substance with the latter formula showing an  $NH_2$  group would be attacked by nitrous acid; isocyanic acid, which is easily hydrolyzed to ammonium carbonate, would also yield nitrogen.

"This alternative formula for urea is supported by the behaviour of semicarbazide and urethane. One-third of the nitrogen of semicarbazide was obtained as gas in the presence of acetic acid, rather more in the presence of 2 or 3 c.c. of hydrochloric acid. One of the three nitrogen atoms would thus be present as an  $-NH_2$  group. In presence of more hydrochloric acid, large volumes of gas were evolved, suggesting that hydrazine was formed by decomposition. Hydrazine in another experiment was observed to produce large volumes of gas, resulting probably from reduction of nitrous acid by hydrazine.

"Urethane behaved like the simple amides: no evolution of nitrogen in presence of acetic acid, but complete reaction in presence of hydrochloric acid. It would thus appear to have the alternative formula,  $OEt.C(OH):NH$ , which changes into  $OEt.CO.NH_2$  in presence of mineral acid. The behaviour of biuret with nitrous acid is most easily explained by Werner's formula,  $NH:C(OH).NH.C(OH)$ . In presence of acetic acid, this would change to  $NH:C(ON).NH.CO.NH_2$  with liberation of one-third of its nitrogen gas, as found by experiment; in the presence of 2 to 3 c.c. of hydrochloric acid, the formula would become  $NH_2.CO.NH.CO.NH_2$ ; two-thirds of the nitrogen was given off. In the presence of 4 to 6 c.c. of hydrochloric acid, the whole of the nitrogen was evolved, indicating that the molecule was completely broken down.

"Guanidine reacted only slightly in presence of acetic acid, two-thirds of its nitrogen was given off in presence of 5 c.c. of hydrochloric acid, and the

reaction was nearly complete in presence of 8 c.c. of hydrochloric acid in

twenty-three hours. The alternative formula,  $\text{HN} \begin{array}{c} \diagup \text{NH} \\ | \\ \text{C} \end{array} \text{—NH}_2$ ; proposed by Krall, is indicated for guanidine. This changes to the usually adopted formula  $\text{HN}:\text{C}(\text{NH}_2)_2$ , in presence of mineral acid which explains the liberation of two-thirds of its nitrogen in presence of hydrochloric acid.

“Arginine behaved in a similar way to guanidine. Only the  $\alpha$ -amino-group reacts with nitrous acid in presence of acetic acid. This reaction is used in its analysis. An excess of nitrogen over one-third was found by Plimmer<sup>1</sup> if the reaction were prolonged. The whole of its nitrogen is given off as gas in the presence of hydrochloric acid.

“Aminoguanidine gave off one-quarter of its nitrogen as gas in presence of acetic acid, but larger quantities in presence of hydrochloric acid. Corresponding with guanidine, the whole of the nitrogen was not evolved as gas. Creatine acted in a similar way to guanidine and appears to have an alter-

native formula such as  $\text{CO}_2\text{H}.\text{CH}_2.\text{N}(\text{Me}).\text{C}=\text{N}$ , which changes to the usual formula,  $\text{CO}_2\text{H}.\text{CH}_2.\text{N}(\text{Me}).(\text{C}(\text{NH}).\text{NH}_2)$ , in presence of hydrochloric acid. A volume of nitrogen was evolved corresponding to two nitrogen atoms. The third nitrogen atom, to which the methyl is attached, would not be expected to yield nitrogen. Creatinine, which was also found by Wright Wilson to react with nitrous acid in presence of acetic acid, showed an unexpected behaviour, indicating the presence of an amino-group. It would thus appear to have an alternative formula such as (I) instead of (II).



“The effect of mineral acid in diminishing the volume of nitrogen evolved may be due to a change of the new alternative formula to the commonly adopted one. The formation of the smaller amounts in the experiments may be due to the method of adding the hydrochloric acid, 1 c.c. at a time; a certain volume would be liberated before the whole of the 6 or 8 c.c. could be introduced.”

Plimmer sums up his conclusions as follows:—

1. Amides and urethanes do not react with nitrous acid in presence of acetic acid.
2. Both react quantitatively in presence of approximately 2N hydrochloric acid.
3. Urea reacts quantitatively with nitrous acid in presence of acetic acid.

<sup>1</sup> Biochem. J., 18, 105 (1924).

4. Biuret reacts with one nitrogen atom in presence of acetic acid, with two nitrogen atoms in presence of small amounts of hydrochloric acid, and with three nitrogen atoms in presence of 2N hydrochloric acid.

5. Guanidine and creatine do not react with nitrous acid in presence of acetic acid, but give off nitrogen in presence of hydrochloric acid. Arginine, excepting its primary  $\alpha$ -amino-group, behaves in a similar way.

6. Creatinine gives off nitrogen corresponding to one nitrogen atom with nitrous acid in presence of acetic acid; the volume of nitrogen evolved is diminished in presence of hydrochloric acid.

7. If nitrous acid in presence of acetic acid is a reagent for the presence of an  $-\text{NH}_2$  group, amides and other compounds investigated will possess alternative formulae, which, in presence of hydrochloric acid, change to the usually accepted formulae for these compounds.

This is a very nice piece of work; but the author spoils his effect by his conclusion 7, in which he hedges. What we have a right to ask of him is that he shall say definitely where he stands, whether he believes that nitrous acid is a reagent for  $-\text{NH}_2$  groups, and whether he believes that what he calls the alternative formulas are the right ones. If he had not balked at the last hurdle, one would have applauded him whether one agreed with him or not. As the matter stands, the author has said substantially: These results seem to me to indicate new formulas; but I do not dare commit myself on such an important matter, and I leave the matter to the judgment of others. That is no way to do scientific work. A man must at least believe in himself.

Hynd and McFarlane<sup>1</sup> have confirmed Plimmer's work but have had more courage about drawing conclusions. They have studied the effect of nitrous acid on urea, urethane, guanidine carbonate, guanidine nitrite, creatine, creatinine, creatine methyl ester hydrochloride, creatine methyl ester, glycine, glucosimine, glucosamine, glucosamine hydrochloride, glucose ureide, glucose ureide-urea, lactose ureide, glucosamine plus urea condensation product.

"With the exception of the product obtained in an attempt to condense urea with glucosamine, all the compounds are divided, though perhaps not sharply into three groups, according as the reaction proceeds (1) rapidly, or (2) slowly in the presence of a weak organic acid such as hydrochloric acid or sulphuric acid, to bring about a significant evolution of nitrogen gas. Typical examples in the first group are glycine and glucosimine; in the second group urea, glucose ureide, glucosamine, and creatinine; and in the third group, urethane, guanidine, and creatine.

"To account for these differences it is evident that the nitrogen atom or atoms involved must be linked in various ways, which it should be possible to indicate by means of structural formulae. Although guanidine, on this basis of structure, may be regarded as the parent compound, it will be advisable to deal first with urea, as its structure has been more fully investigated.<sup>2</sup>

<sup>1</sup> *Biochem. J.*, 20, 1264 (1926).

<sup>2</sup> "The Chemistry of Urea" (1923).

"Urea. Werner<sup>1</sup> claims that urea is not attacked by pure nitrous acid alone or even when a second very weak acid is present. Consequently the practically complete, though slow, decomposition of urea by nitrous acid in the presence of acetic acid here recorded may seem at first sight contrary to this statement, but it is to be noted that the experimental conditions were widely different. In the first place, the concentration of both acetic acid and nitrous acid in our experiments were high, and, secondly, conditions for the partial decomposition of the nitrous acid, according to the equation

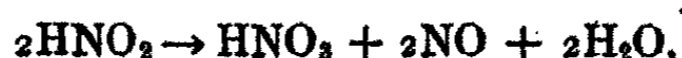

are favourable during Van Slyke's process, especially when the reaction is allowed to proceed for a long period such as twenty-four hours at 20°. However, as Werner's experiments lasted from one to three days at 13°, neither the temperature nor the duration of the reaction appears to be an important factor, though both Dunn and Schmidt<sup>2</sup> and also Wilson<sup>3</sup> have observed the rate of deamination of certain amino-compounds to be affected by temperature. It seems reasonable to suppose that in our experiments the hydrogen ion concentration of the medium became sufficiently high slowly to convert urea from its inactive cyclic structure into its reactive open form. Further support is given to this view by the fact that the addition of a strong acid rapidly brought about complete deamination. Accordingly urea in a neutral medium exists as a ring compound, represented by I or III, either of which becomes converted into the iso-carbamide structure II on increase of hydrogen ion concentration. The free amino-group is then attacked by nitrous acid, nitrogen being liberated, and the residual cyanic acid, as explained by Werner, yields a second atom of nitrogen.

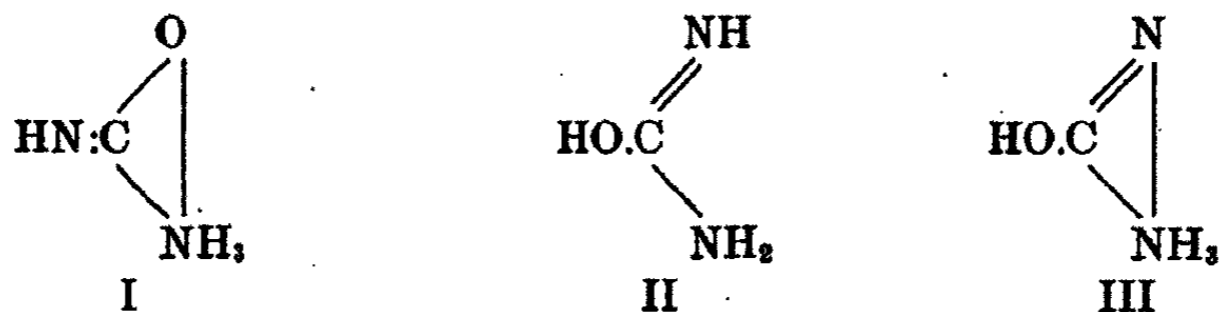

"Structure I is that proposed by Werner, but we are inclined to favour III, for, as will be clear from what follows, its adoption brings urea, guanidine, and creatine better into line.

"Guanidine. We find that guanidine, in presence of acetic acid, reacts with nitrous acid only very slightly if at all, while in presence of the necessary amount of mineral acid practically the whole of the nitrogen is evolved after twenty-four hours. These results agree with the experimental findings of Plimmer,<sup>4</sup> but are contrary to the observations of Krall,<sup>5</sup> who states that nitrous acid reacts slowly and liberates nitrogen correspondingly with no

<sup>1</sup> J. Chem. Soc., 111, 863 (1917).  
<sup>2</sup> J. Biol. Chem., 53, 401 (1922).  
<sup>3</sup> J. Biol. Chem., 56, 183 (1923).  
<sup>4</sup> J. Chem. Soc., 127, 2651 (1925).  
<sup>5</sup> J. Chem. Soc., 107, 1396 (1915).

more than one of the three nitrogen atoms, even when an excess of a strong acid is present. Consequently, this worker suggested that guanidine in solution as the free base is a mixture, in approximately equal proportions, of the isomerides IV and V formulated below, strong acid increasing the proportion of the latter, whereas alkali hydroxides increase the proportion of the former. This view is also supported by the recent study of the hydrolysis of guanidine carried out by Bell.<sup>1</sup> Plimmer, on the other hand, considers guanidine to have formula IV changing to VI in the presence of mineral acid, which he holds explains the liberation of two-thirds of its nitrogen in the presence of hydrochloric acid.

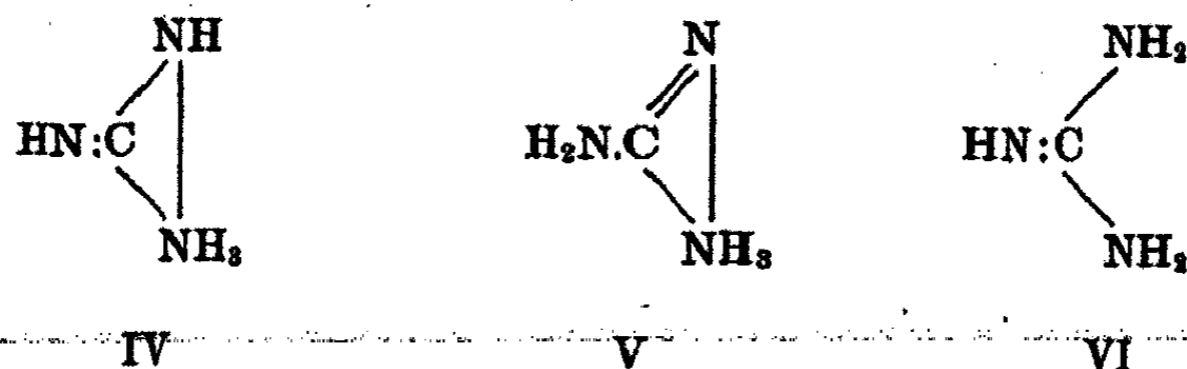

Taking cognisance of the fact that all attempts to prepare a dihydrochloride from guanidine have been unsuccessful, we take the view that guanidine is best represented by the structure:

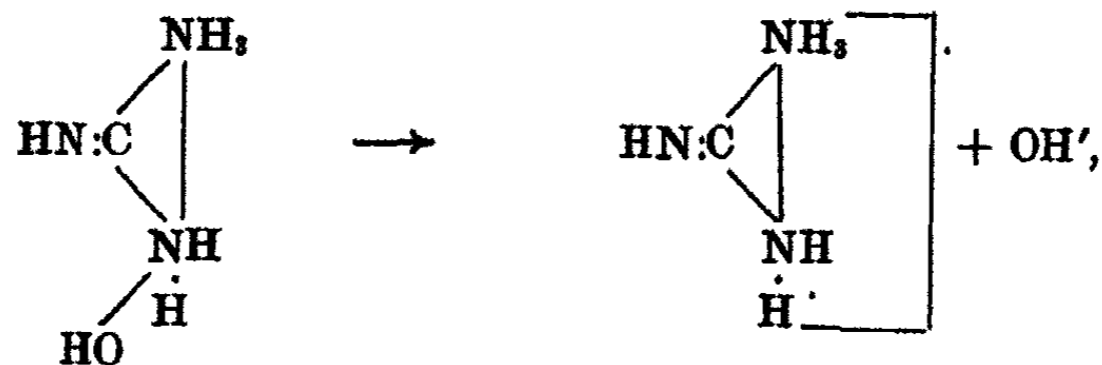

which, as indicated, would dissociate as a strong base, and form stable salts even with weak acids. Such salts would be hydrolytically dissociated and accordingly their solutions would have an alkaline reaction. This is in agreement with the well-known fact that guanidine carbonate,  $(\text{CH}_5\text{N}_3)_2\text{H}_2\text{CO}_3$  is comparable with sodium carbonate and forms strongly alkaline solutions. Further, we have found that a solution of guanidine nitrite can be obtained by mixing equivalent quantities of guanidine carbonate and barium nitrite and then removing the precipitated barium carbonate by filtration. No evolution of nitrogen was observed from a M/20 guanidine nitrite solution which had pH 9 approximately. This stability is consistent with the isolation by Thiele<sup>2</sup> of nitroso guanidine, to which he assigned the formula  $\text{H}_2\text{N:C}(\text{:NH})\text{NH}\cdot\text{NO}$ . Accordingly, owing to the stability and strongly basic nature of the guanidine ion, no reaction with nitrous acid takes place in the

<sup>1</sup> J. Chem. Soc., 129, 1213 (1926).

<sup>2</sup> Ann., 273, 133 (1893).



presence of acetic acid, that is, decomposition does not occur so long as the hydrogen ion remains low. On increasing the hydrogen ion concentration, as by the addition of hydrochloric acid, evolution of nitrogen ensues. During this process, there is probably conversion to the structure

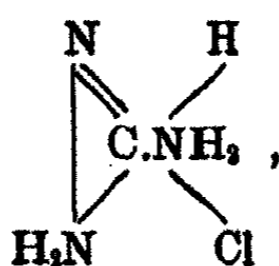

the free amino-group then reacting normally with nitrous acid, nitrogen being liberated and the rest of the molecule appearing as structure III above, which in the presence of mineral acid would pass into II. Consequently, urea is to be regarded as the first intermediate product in the decomposition of guanidine by nitrous acid. The subsequent stages being those already indicated for urea, the whole of the nitrogen is liberated, a result in accord with the behaviour of arginine under similar conditions (Plimmer). It is to be noted, however, that it would be impossible to detect the intermediate formation of urea, as, under the conditions necessary for the first stage of the reaction which is a slow one, the urea would be decomposed as fast as it is formed.

"The conversion of form IV to V is not regarded by us as a simple tautomeric change produced by the wandering of a hydrogen atom from the NH in the ring to the NH outside the ring. The initial step seems to involve rupture of the bond between the two ring nitrogen atoms. Redistribution of the hydrogen atoms then occurs with the formation of a ring structure, in which the nitrogen atom outside the original ring structure now takes part, while that one of the original ring-nitrogen atoms, which is now outside, carries the additive salt molecule. This gives a satisfactory explanation of the existence of non-acid salts of guanidine. However, probably owing to the presence of the double bond, the ring structure in V is not so stable as that in IV and can be ruptured even by a weak acid, so that in solution a salt of guanidine with a strong acid may exist as represented in form VI.

"*Creatine.* From the fact that both Volhard and Horbaczewski used sarcosine as the starting material for their syntheses of creatine, it is clear that the methyl and the carboxyl-methyl groups must be linked to the same nitrogen atom. Further, as the compound reacts towards nitrous acid in the

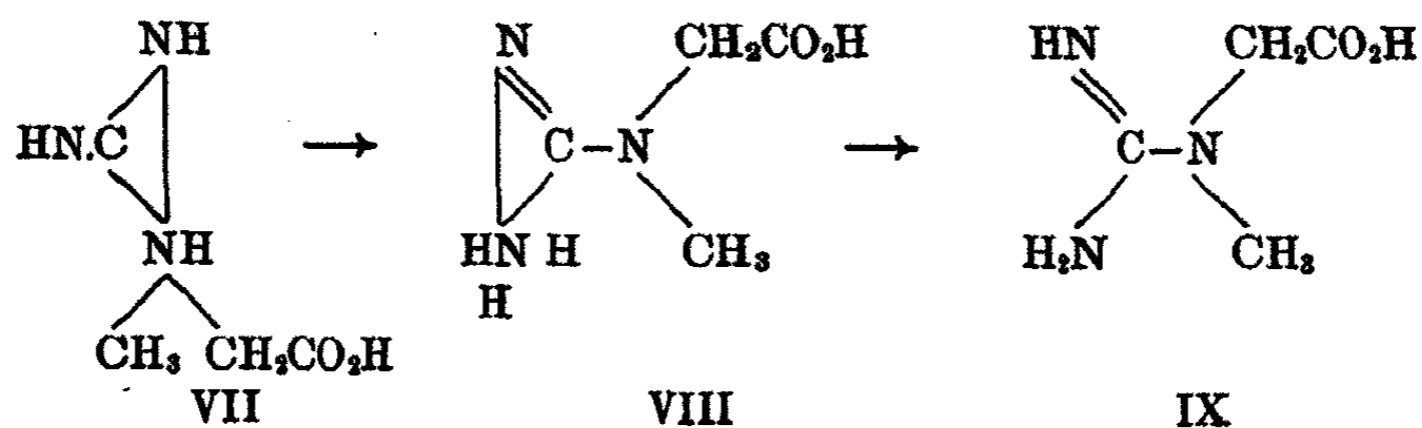

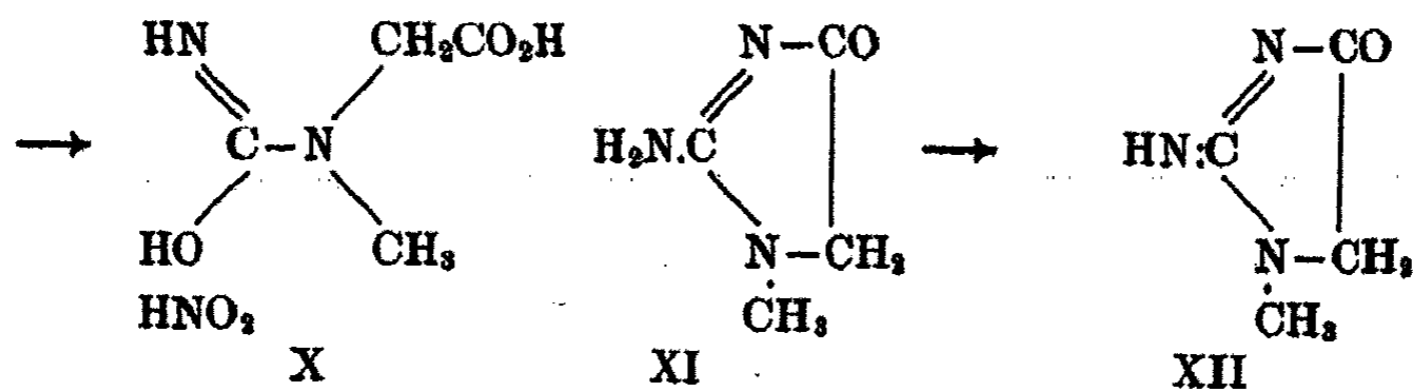

same way as guanidine, it appears to us to have structure VII, in solutions of low hydrogen ion concentration, which, as explained in the case of guanidine, tautomerises to the form VIII when the hydrogen ion concentration is sufficiently high. In solution conversion to IX would occur, and consequently on reaction with nitrous acid one nitrogen atom would be liberated.

*“Creatinine.* Further action of hydrochloric acid on compound VIII brings about rupture of the bond between the nitrogen atoms and dehydration occurs, probably without the intermediate formation of IX, so that creatinine results with structure XI. Consequently we find, as previously reported by Plimmer and also by Wilson, that creatinine reacts with nitrous acid in the presence of acetic acid to lose one of the three nitrogen atoms. The same result is obtained in presence of hydrochloric acid unless excessive amounts are used. Plimmer explains the effect of mineral acid in decreasing the amount of nitrogen evolved as due to a change to the alternative structure XII. However, as a similar retarding influence was noticed by us in the case of urea when excessive amounts of sulphuric acid were used, the correct explanation is not clear. In this connection it may be noted that no difference was produced in the result of the decomposition of glycine by nitrous acid in presence of acetic acid by adding excess of sulphuric acid.

*“Creatine methyl ester hydrochloride.* This compound has been claimed by Kapfhammer<sup>1</sup> to be a derivative of creatinine, but, as 65.1% of the total nitrogen is evolved on reaction with nitrous acid in the presence of sulphuric acid, the compound was correctly described by Dox and Yoder<sup>2</sup> as the hydrochloride of creatine methyl ester. However, as 41.3% of the total nitrogen is liberated from the compound when its solution is shaken with a slight excess of silver carbonate and then decomposed by nitrous acid in the presence of acetic acid, removal of the salt molecule evidently involves destruction of the ester with elimination of methyl alcohol and the resulting formation of creatinine. This would seem to give a satisfactory explanation of Kapfhammer's observations.

*“Glucosimine and glucoscimine.* The former compound, like glycine, was found to yield the same results with acetic and sulphuric acids. In both

<sup>1</sup> Biochem. Z., 156, 182 (1925).

<sup>2</sup> J. Biol. Chem., 54, 671 (1922).

cases, rapid decomposition of glucosimine with nitrous acid occurs, as noted by Levene<sup>1</sup>, and also by Schmuck.<sup>2</sup>

"This behaviour forms a marked contrast to that of glucosamine, which required eighteen hours for complete decomposition in the presence of acetic acid. This supports the view that glucosimine should be formulated with a free amino-group, as in XIII, while glucosamine, as it reacts in a manner similar to urea, must contain in its molecule, as previously suggested by Irvine and Hynd,<sup>3</sup> the modified betaine ring structure, as in XIV, which in the presence of mineral acid changes to XV; accordingly the compound yields the total amount of nitrogen in about half an hour.

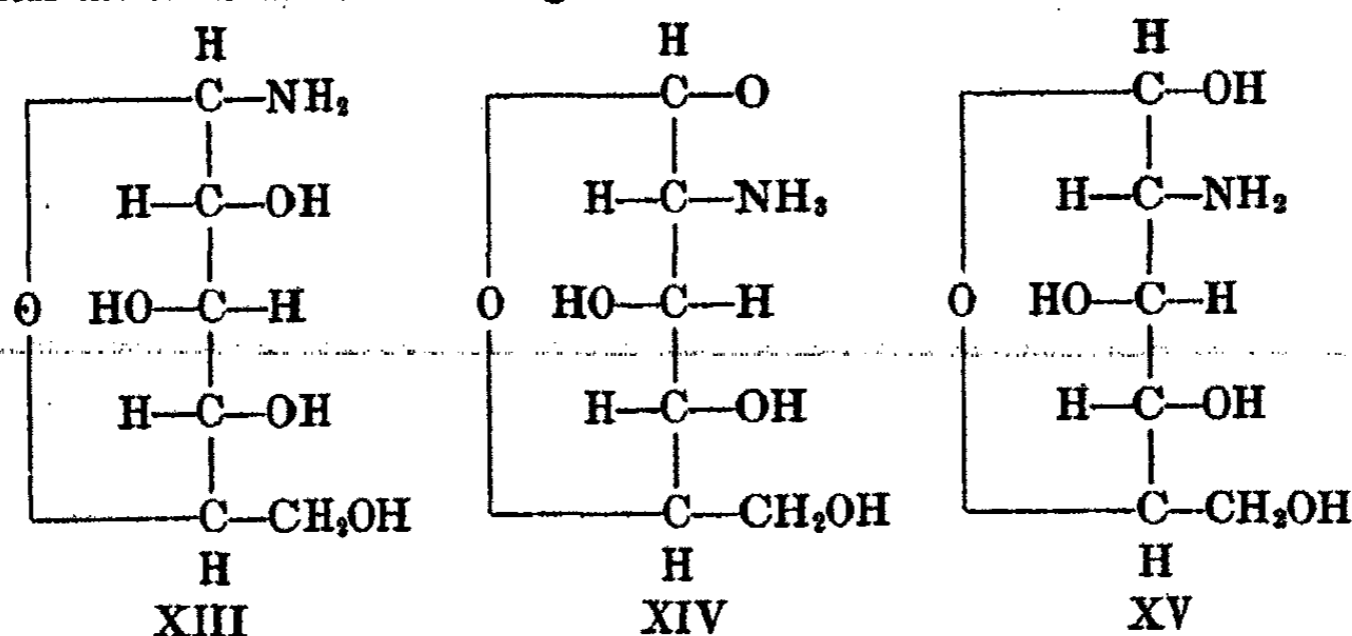

"Ureides. (1) *Glucose ureides*. The formula XVI originally assigned to this compound by Schoorl<sup>4</sup> requires modification in two respects. Alteration of the glucose portion to an oxidic ring structure,<sup>5</sup> probably anylene oxide, as in XVII, gives a better explanation of the results obtained in acetylation. With regard to the urea portion, no free amino-group is present, as with nitrous acid in the presence of acetic acid only slow evolution of nitrogen amounting to about 50% of the total nitrogen was obtained. Consequently a ring structure like that in urea is indicated as the alternative form XVIII, on the analogy of the behaviour of urethane and the acid amides, would not be expected to yield any nitrogen in the presence of acetic acid.

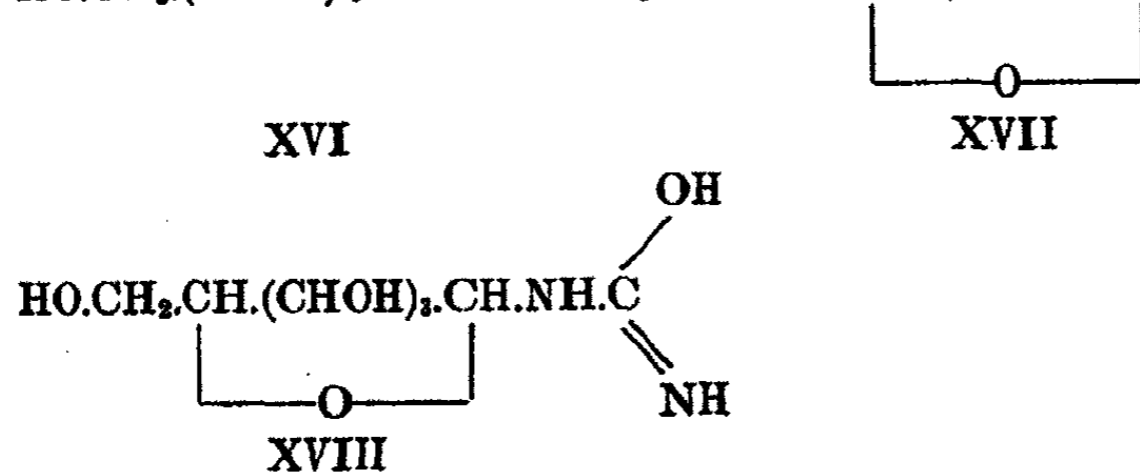
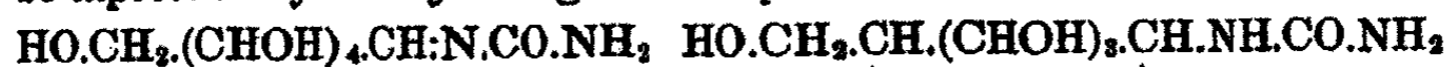

<sup>1</sup> J. Biol. Chem., 24, 59 (1916).  
<sup>2</sup> Ber., 56B, 1817 (1923).  
<sup>3</sup> J. Chem. Soc., 103, 41 (1913).  
<sup>4</sup> Rec. Trav. chim., 22, 31 (1903).  
<sup>5</sup> J. Chem. Soc., 103, 41 (1913)

"With regard to ring structures three possibilities exist, which, if we write G for the glucose residue, may be presented as follows:

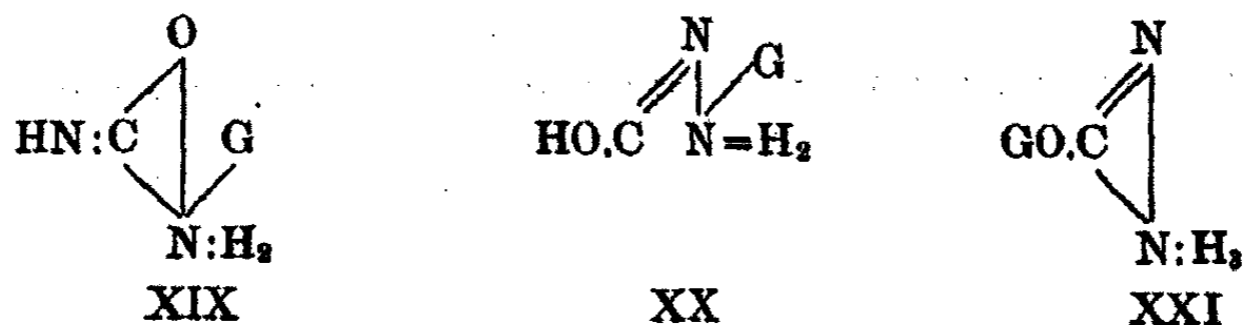

"In the presence of acetic acid these would exist as XXII, XXIII, and XXIV respectively:

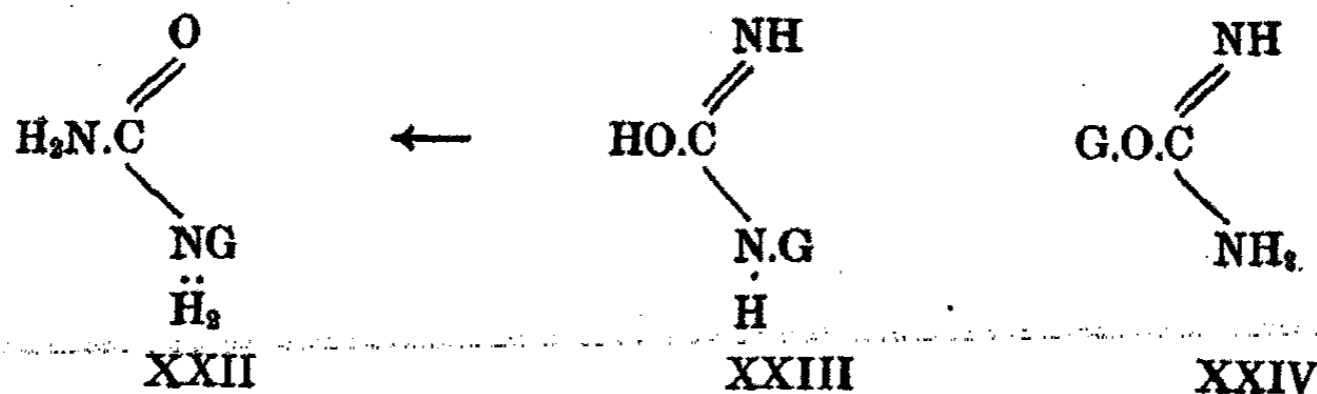



XXIII then passing into XXII. With the data at present available it is impossible to decide which of the above ring structures should be adopted for the compound, but from the results of another series of experiments which are all but complete, it is hoped that it will be possible to make a definite choice.

"The fact that 50% of the total nitrogen is readily obtained by reaction with nitrous acid either in the presence of acetic acid or sulphuric acid, while even in the presence of mineral acid the reaction requires to be continued for several hours at 50° before 100% of nitrogen is liberated, suggested that it might be possible to isolate an intermediate product and thereby furnish experimental evidence in support of Werner's views on the structure of urea and its derivatives. Various experiments were carried out with this end in view, using either silver nitrite and hydrochloric acid or barium nitrite and sulphuric acid to generate the necessary nitrous acid, but all ended in failure. The only crystalline product isolated was a small proportion of unchanged glucose ureide (mixed M.P. 203°. The main organic product obtained was an extremely hygroscopic syrup, which could not be obtained crystalline. It reacted like glucose."

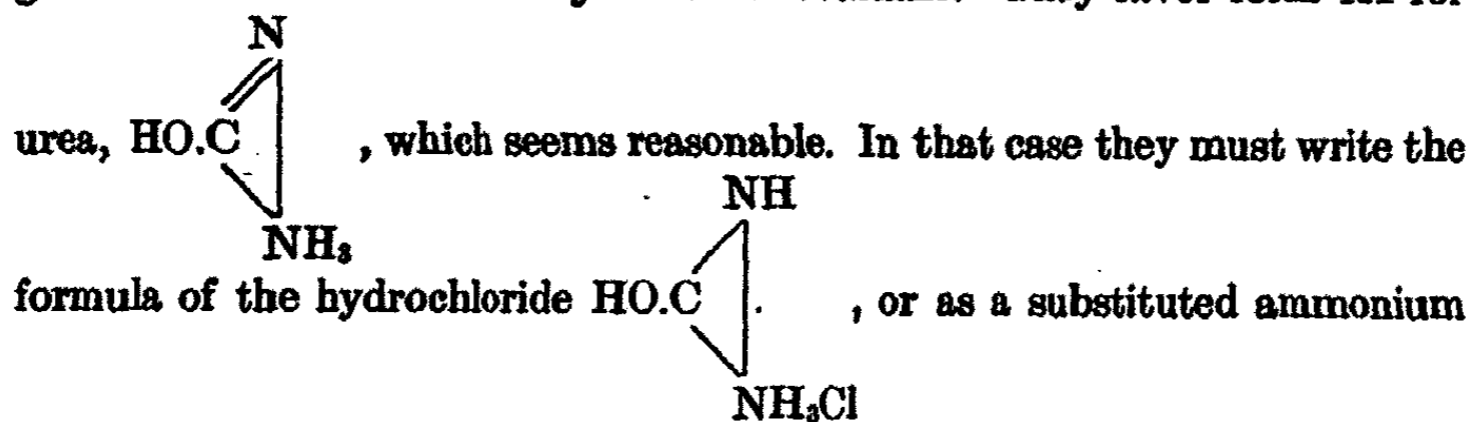
There is one point in which there might be a difference of opinion in regard to the conclusions of Hynd and McFarlane. They favor form III for

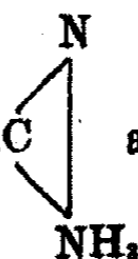

ion and a chlorine anion. When they come to guanidine, they throw this

overboard and write the two formulas  $\text{H}_2\text{N}\cdot\text{C}$   and   $\text{C}\cdot\text{NH}_2\text{Cl}$ . To be

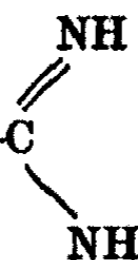
consistent, they should have written the second formula  $\text{H}_2\text{N}-\text{C}$    $\cdot$ .

Two of what we ordinarily call pentavalent nitrogens attached to one carbon seem to be overdoing things unless it is absolutely necessary.

Most organic chemists nowadays follow Hantzsch in considering the diazotization of aniline hydrochloride as an ion reaction.

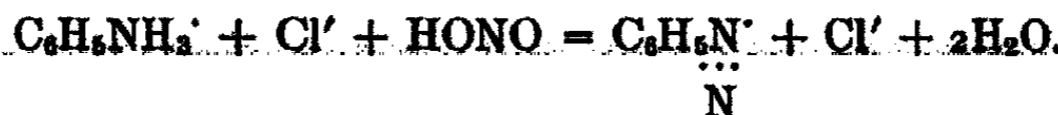

One could assume of course the decomposition of aniline nitrite

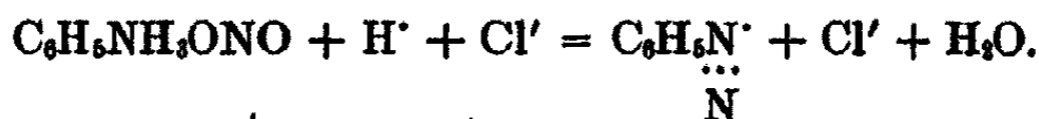

There does not seem any real justification for assuming, as Hynd and McFar-

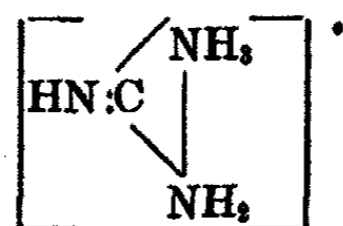
lane do, the existence of the cation .

Hynd and McFarlane were rather forced to adopt their quite unpleasant formula in order to account for guanidine not forming a dihydrochloride. That difficulty has been removed by the stipulation that, in general, only one of the nitrogens attached to a given carbon can react stoichiometrically with hydrogen chloride. Also, the explanation by Hynd and McFarlane did not really meet that difficulty at all; because they are making the tacit assumption that only  $\text{NH}_2$  groups add hydrogen chloride and they know better than that.

Substituting alkyl groups in urea should make it a stronger base and might even cause it to take up two hydrogen chlorides. Franchimont<sup>1</sup> has prepared monomethyl urea, symmetrical dimethyl urea, trimethyl urea, and tetramethyl urea, and has made the nitrates but has not determined how many nitrates are formed. This would be rather unsatisfactory anyway, because one would only get a mononitrate with dilute acid, while a more

<sup>1</sup> Rec. Trav. chim., 3, 216 (1884).

concentrated acid will decompose the urea. As a matter of fact, what Fran-  
chimon<sup>1</sup> actually studied was the decomposition of the substituted ureas by  
concentrated acid.

Haber and Limpricht<sup>1</sup> rather imply that diethyl urea takes up two hydro-  
gen chlorides; but they speak of getting a viscous mass, which does not sound  
right and which may have meant decomposition. We tested diethyl thio-  
urea, which we were able to buy from the Eastman Kodak Company, and  
found it to be a monacid base<sup>2</sup> under our conditions, Fig. 2. Wallach<sup>3</sup> says  
that tetraethyl urea is basic, as of course it must be; but he apparently did  
not analyze the salt. Van der Zande<sup>4</sup> found that unsymmetrical dimethyl  
urea crystallizes with one of oxalic acid, while urea crystallizes with one-half  
of oxalic acid. Dimethyl urea and urea crystallize with the same amount of  
picric acid. It is not safe, therefore, to conclude that dimethyl urea will  
crystallize with two hydrogen chlorides, though this seems probable. On the  
other hand unsymmetrical diethyl urea crystallizes with the same amount  
of oxalic acid that urea does. This implies that diethyl and dimethyl urea  
are on opposite sides of the dividing line; but the experiments were done in  
much too haphazard a fashion to warrant such a conclusion. It must be  
remembered that at that time nobody except Bakhuis Roozeboom knew any-  
thing about the practical application of the phase rule. As an illustration  
of the confusion, unsymmetrical dipropyl urea behaves like the diethyl urea  
with regard to oxalic acid. On the other hand it crystallizes with two of  
nitric acid; while the unsymmetrical di-isopropyl urea crystallizes with one  
of nitric acid. Somebody should study the action of hydrogen chloride on  
all the alkyl-substituted ureas.

With aryl-substituted ureas the tendency to combine with hydrogen  
chloride should decrease and might become zero. This actually occurs.  
Hofmann<sup>5</sup> reports that he was "unable to make phenyl urea combine with  
acids to form compounds analogous to urea nitrate and oxalate. The presence  
of acid increased the solubility but slightly and the crystals obtained on cool-  
ing contained no acid. All attempts to make a platinum double salt were  
also futile." In line with this is the fact that diphenyl urea, triphenyl urea,  
and tetraphenyl urea apparently show no basic properties.

If we write the formula for acetyl urea as  $\text{CH}_3\text{CO.NH.CO.NH}_2$ , the solid  
should add one hydrogen chloride. We have not found any reference in the  
literature to this taking place and must therefore leave it open whether the  
experiment or the formula is wrong. Moldenhauer<sup>6</sup> reports that nitric acid  
does not precipitate but that cannot be accepted as proof positive that no  
hydrochloride can be formed. Diacetyl urea,  $\text{CH}_3\text{CONH.CO.NH.COCH}_3$ ,  
contains two sets of diketo linkages and therefore should not add hydrogen  
chloride and apparently does not.

<sup>1</sup> Ann., 109, 107 (1859).

<sup>2</sup> This had to be run at about  $-70^\circ$  in order to get a solid compound.

<sup>3</sup> Ann., 214, 275 (1882).

<sup>4</sup> Rec. Trav. chim., 8, 222 (1889).

<sup>5</sup> Ann., 70, 135 (1848).

<sup>6</sup> Rec. Trav. chim., 8, 222 (1889).

In barbituric acid, parabanic acid, dialuric acid, the two sets

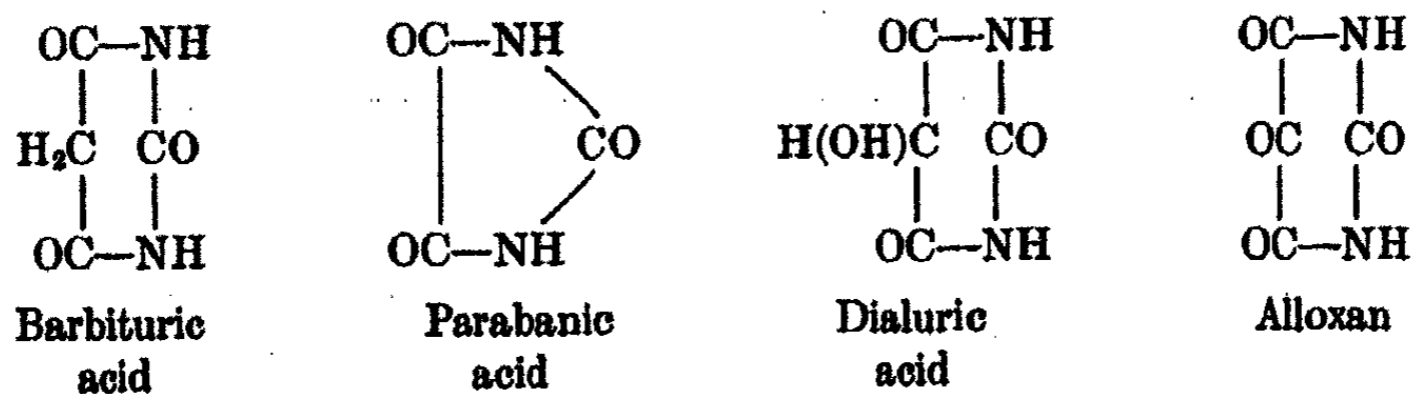

of diketo linkages keep the two nitrogens from taking up hydrogen chloride. We have checked in the case of barbituric acid and of alloxan; neither forms a compound with hydrogen chloride under the conditions of the experiment. Veronal would of course behave like barbituric acid. Biuret contains three nitrogens but should be discussed here because of its bearing on urea. If we write the formula in the usual manner as  $\text{H}_2\text{N.CO.NH.CO.NH}_2$ , hydrogen chloride cannot add to the imide nitrogen because of the diketo linkage. If it adds to either of the end nitrogens, it will add to the other also and biuret would then add two hydrogen chlorides. According to the literature, biuret is a monacid base and our experiments confirm this, Fig. 2. The formula must therefore be wrong.

If we adopt the formula suggested by E. A. Werner and approved by Plimmer, our troubles disappear. We then write



and hydrogen chloride adds to the middle nitrogen, it being the most basic because it is attached to two aliphatic carbons. With hydrogen chloride added to the middle nitrogen, the other two nitrogens are barred because each is attached to a carbon to which there is already a pentavalent nitrogen attached.

A somewhat similar case, though with three nitrogens, is furnished by succinimidine. Meyer and Jacobson<sup>1</sup> write the formula for the hydrochloride:—

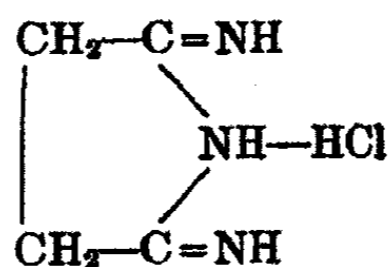

If we write the formula this way each of the other nitrogens is attached to a carbon to which the middle nitrogen is attached. If we ask why one hydrogen chloride combined with the middle nitrogen, instead of two hydrogen chlorides combining with the end nitrogens, the only possible answer seems to be that the middle nitrogen is attached to two aliphatic carbons and is consequently more basic.

<sup>1</sup> "Handbuch der organischen Chemie," 1, 662 (1893).

Another case in which the formula is apparently wrong is uracil. The

formula is usually written  $\begin{array}{c} \text{NH}-\text{CH} \\ \diagdown \quad \diagup \\ \text{OC} \quad \text{CH} \\ \diagup \quad \diagdown \\ \text{NH}-\text{CO} \end{array}$ . The nitrogen in the lower

line cannot add hydrogen chloride, because of the diketo linkage and the nitrogen in the upper line cannot do so because of the carbonyl group on one side and the aliphatic double bond on the other side. Consequently uracil should have no basic properties. Actually it is a weak base, adding one hydrogen chloride when the pressure gets up to about 20 mm, Fig. 1. Some one of the hydrogens must have moved and it is immaterial for our purposes which one. Any one of the four formulas written here will meet the requirements and there may be other

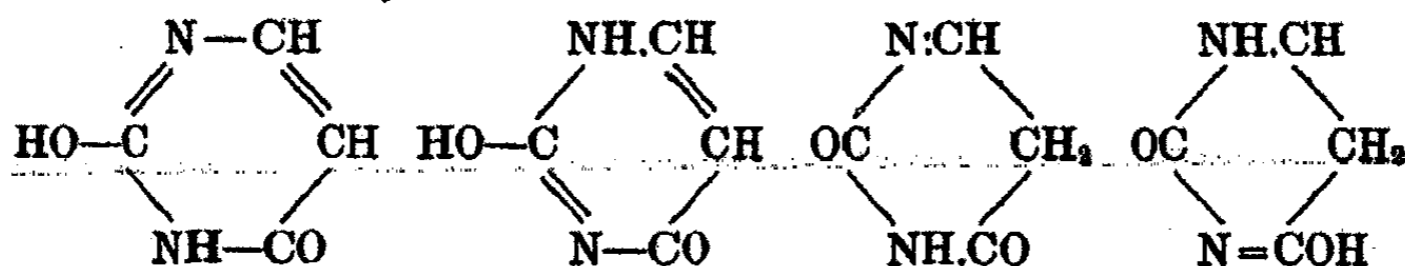

possible variants. When we come to uramil,  $\begin{array}{c} \text{NH}-\text{CO} \\ \diagdown \quad \diagup \\ \text{OC} \quad \text{CH}\cdot\text{NH}_2 \\ \diagup \quad \diagdown \\ \text{NH}-\text{CO} \end{array}$ , hydro-

gen chloride adds to the free amino group and the other two nitrogens do not get into the picture because of the diketo linkages, Fig. 1.

Baeyer<sup>1</sup> says that hydantoin,  $\begin{array}{c} \text{NH}-\text{CH}_2 \\ \diagdown \quad | \\ \text{OC} \quad \text{NH}-\text{CO} \\ \diagup \quad | \\ \text{NH}-\text{CO} \end{array}$ , is an indifferent substance

and can be precipitated unchanged from aqueous solution by hydrochloric acid. On the other hand, it obviously should add one hydrogen chloride, and methylhydantoin<sup>2</sup> does. There is something here which needs straightening out.

Owing to the presence of the nitro group, nitro-urea, methyl and ethyl nitro-ureas are not bases, nitro-urea being classed as a strong acid<sup>3</sup> whose potassium salt reacts neutral.

Benzoylene urea has the formula,  $\begin{array}{c} \text{CO}\cdot\text{NH} \\ \diagdown \quad | \\ \text{C}_6\text{H}_4 \quad \text{NH}-\text{CO} \\ \diagup \quad | \\ \text{NH}-\text{CO} \end{array}$  and is about on the

<sup>1</sup> Ann., 130, 158 (1864).

<sup>2</sup> Traube: Ber., 15, 2110 (1882).

<sup>3</sup> Meyer and Jacobson: "Handbuch der organischen Chemie," 1, II, 1394 (1913).



dividing line so far as prediction goes. The nitrogen with the diketo linkage cannot of course add on hydrogen chloride. The other nitrogen is between a carbonyl group and the negative, phenyl group. That would not in itself be enough to destroy the basic character; but there is the other carbonyl group attached to the phenyl group and we cannot evaluate that at present. From the literature it looks as though benzoylene urea added no hydrogen chloride.

Dibenzoyloxyurea<sup>1</sup> has the formula  $\text{CO}(-\text{NHOC}_6\text{H}_5)_2$  and obviously cannot add on any hydrogen chloride. Another substance which contains no basic nitrogens is bisnitrosyl benzyl<sup>2</sup>  $\text{C}_6\text{H}_5-\text{CH}_2.\text{N}-\text{O}$

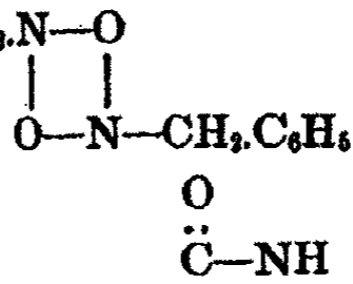

According to Koerner<sup>3</sup>  $\beta$ -phenyl- $\alpha$ -oxyquinazoline,  $\text{C}_6\text{H}_4$ , is a

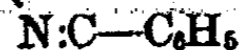

weak monacid base. As the two nitrogens are attached to the same carbon, this is what one would expect. The amidoximes are monacid bases for the same reason.

According to Meyer and Jacobson<sup>4</sup> 2-oxoquinazoline dihydride has the

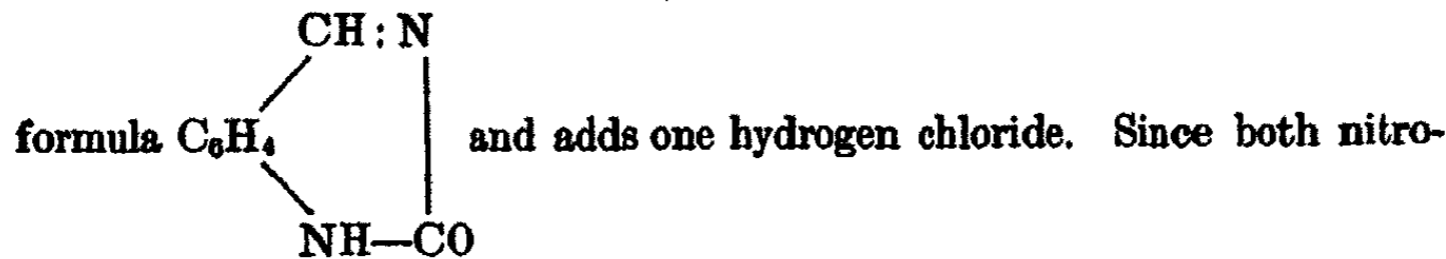

gens are attached to the same carbon, this is as it should be. A somewhat similar case is that of pyrazolone, for which at least four formulas may be written:—



No matter how one writes the formula, there are always two nitrogens linked together and consequently pyrazolone adds only one hydrogen chloride. Antipyrin is a substituted pyrazolone and the formula is now written

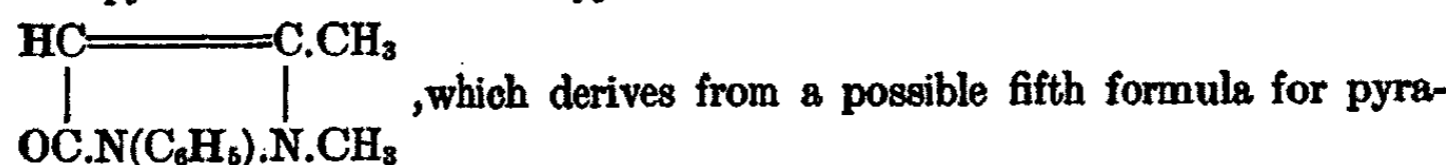

zolone. Owing to the methyl group attached to the nitrogen, antipyrin is a stronger base than pyrazolone.

<sup>1</sup> Michaelis and Schröter: Ber., 26, 2157 (1893).  
<sup>2</sup> Meyer and Jacobson: "Lehrbuch der organischen Chemie," 2, 512 (1902).  
<sup>3</sup> J. prakt. Chem., (2) 36, 158 (1887).  
<sup>4</sup> "Lehrbuch der organischen Chemie," 2, III, 1238 (1920).

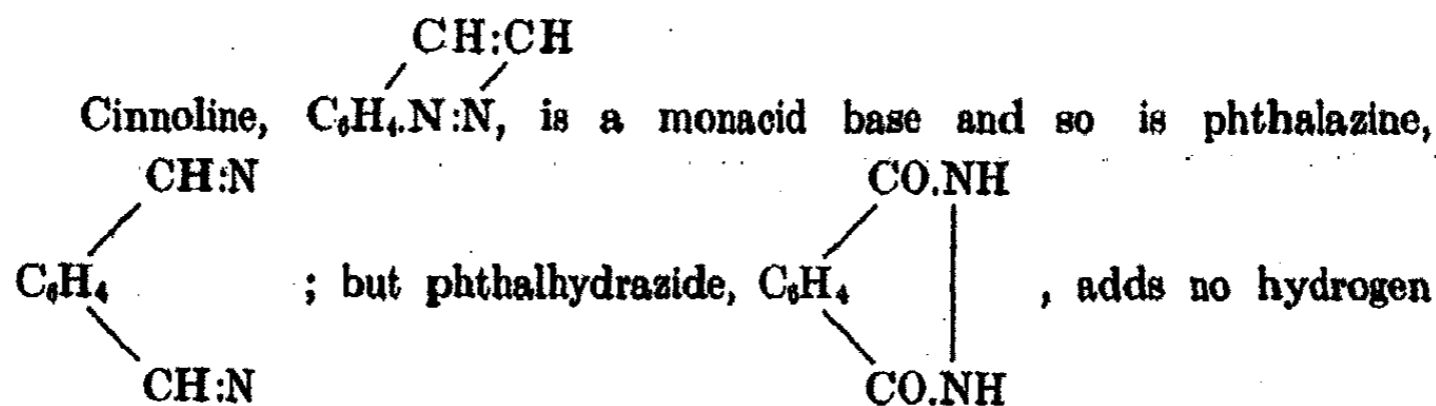

chloride because of the diketo linkage.

In the case of diorthoamidophenol<sup>1</sup> there are no restrictions and the substance adds two hydrogen chlorides. On the other hand there is no statement either way in regard to dibenzoyl- $\beta$ -diamidophenol; but the presumption is that this compound does not take up any hydrogen chloride.

Four isomeric forms of the furodiazoles are distinguished by Meyer and Jacobson:<sup>2</sup>

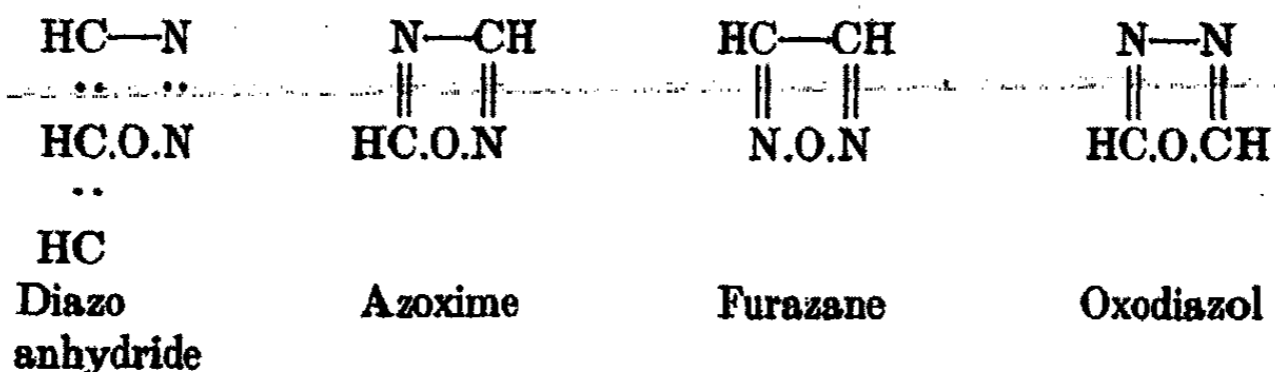

The first should probably not add any hydrogen chloride; the second should add one; the third one none, and the fourth one one.

Troeger<sup>3</sup> describes a compound,  $C_9H_{16}N_2$ , which reacts alkaline and is a monacid base. Troeger assigns to this base the constitutional formula

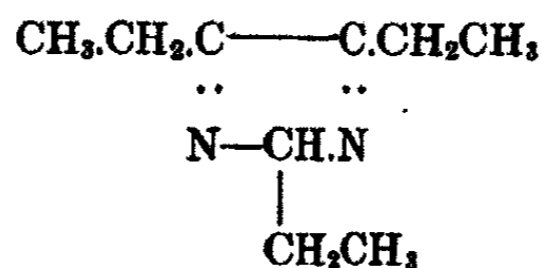

and such a substance should only add one hydrogen chloride because the two nitrogens are attached to the same carbon and the other radicals attached to the nitrogens are not sufficiently basic to overcome this handicap.

We get into trouble, however, with lophine. Meyer and Jacobson<sup>4</sup> adopt the formula suggested by Emil Fischer and confirmed by Japp which differs slightly from that put forward by Troeger:

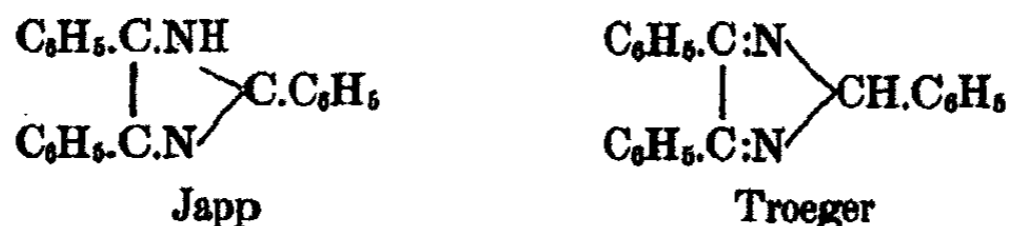

<sup>1</sup> Stuckenberg: Ber., 10, 385 (1877).

<sup>2</sup> "Lehrbuch der organischen Chemie," 2, III, 510 (1920).

<sup>3</sup> J. prakt. Chem., (2) 50, 458 (1894).

<sup>4</sup> "Lehrbuch der organischen Chemie," 2 III, 479 (1920).

Neither of these formulas agree with the experiments of Brunner,<sup>1</sup> who obtained a monohydrochloride by treating with alcoholic hydrochloric acid and a dihydrochloride by treating with hydrogen chloride gas. Meyer and Jacobson refer to the first and ignore the second. From either constitutional formula there should apparently be only one hydrochloride and yet experimentally there are apparently two. This must be checked by somebody.

Among the plant alkaloids<sup>2</sup> nicotine, cuscohygrine, sparteine, quinine, quinidine, cinchonine, cinchonidine, cinchotine, hydrocinchonidine, hydroquinine, and cupreine have each two nitrogens in the molecule and add two hydrogen chlorides.

"Nicotine is a colourless alkaline liquid, b.p. 266°-267°,  $D_4^{20} 1.0778$ ,  $[\alpha]_D -46.41^\circ$ , miscible with water and most organic solvents in all proportions. The salts are laevorotatory, but much less so than the base: the hydrochloride,  $B.2HCl$ , is a gum, and has  $[\alpha]_D -8.27^\circ$ . The platinichloride,  $B.2HCl.PtCl_4$ , forms minute prisms and does not melt below 280°; the aurichloride separates from water in tabular crystals and melts at 186° (*decomp.*); the picrate is precipitated as an oil and gradually changes into large yellow prisms, m.p. 165°", p.59. The structure assigned by Pictet has two rings with one nitrogen in each ring, so that one would naturally expect the addition of two hydrogen chlorides.

"Cuscohygrine boils at 185° under 32 mm. pressure, has specific gravity 0.9767 at 17°, and is optically inactive. It is miscible with water, and forms a crystalline hydrate,  $C_{18}H_{24}ON_{2.3-1/2}H_2O$ , m.p. 40°, and with carbon dioxide forms an unstable carbonate. It yields an oxime, m.p. 53°-54°. The alkaloid forms crystalline salts with acids, has been shown to contain two tertiary nitrogen atoms, and yields hygric acid on oxidation with chromic acid. Liebermann assigned to it the following formula, which Hess and his co-workers<sup>3</sup> modified as shown, chiefly on the ground that a substance having formula I contains two active methylene groups,

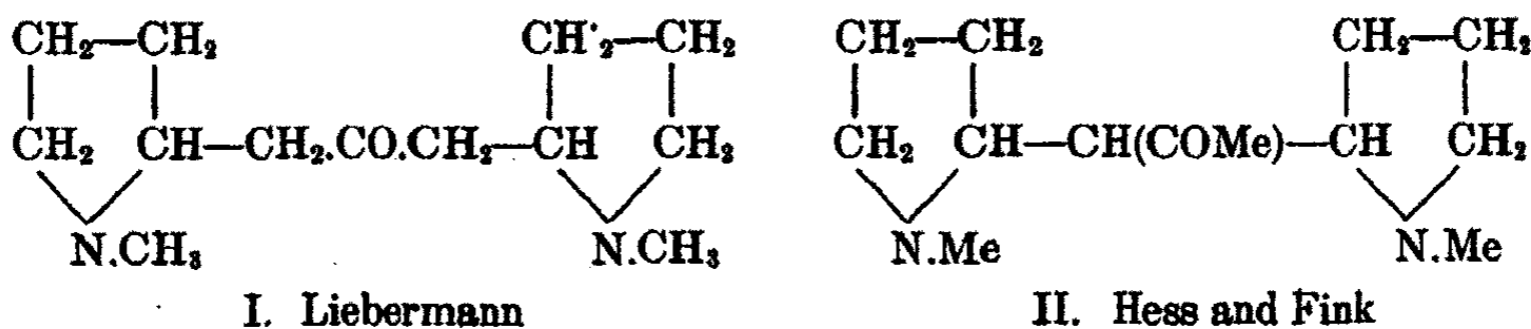

and should form condensation products with benzaldehyde, ethyl oxalate, etc., whilst cuscohygrine does not. The behaviour of the alkaloid with nitric oxide in presence of sodium ethoxide, and the fact that it forms two isomeric hydrazones, are also in favour of the second formula," p. 111.

"Sparteine is a colourless oil,  $D^{20} 1.034$ ,  $D^{20} 1.0196$ ,  $[\alpha]_D^{21} -16.42^\circ$  in alcohol, b.p. 188° under 18 mm. pressure, or 325° in hydrogen under 754 mm. pressure.

<sup>1</sup> Ann., 151, 133 (1869).

<sup>2</sup> T. A. Henry: "The Plant Alkaloids" (1894).

<sup>3</sup> Ber., 53, 781 (1920); 54, 2310 (1921).

It has a bitter taste, an odour recalling that of aniline, and is sparingly soluble in water<sup>1</sup> (1 in 328 at 22°), but readily so in alcohol, chloroform, or ether. The base is strongly alkaline, and is monoacidic to litmus or phenolphthalein, but diacidic to methyl orange. It forms well-crystallised salts and behaves as a diacidic base. The sulphate  $B.H_2SO_4.5H_2O$ , m.p. 136° (*dry*),  $\alpha_D^{16} - 22.12^\circ$  in water, forms transparent, columnar crystals soluble in 1.1 of water at 25°, or 2.4 of alcohol at 25°,  $\alpha_D - 22^\circ$ . This salt is used in medicine. The dihydriodide,  $B.2HI$ , has m.p. 257°-258° (225°, *dry*, Corriez). The platinumchloride  $B.H_2PtCl_6.2H_2O$ , m.p. 243.5° (*decomp.*) forms rhombic prisms from dilute hydrochloric acid; the aurichloride has m.p. 193.4° on immediate precipitation, but after recrystallization melts at 183.4°, and then has a composition represented by the formula,  $B_3.4HCl.3AuCl_3$  (E. Schmidt). The picrate, m.p. 208°, forms glancing yellow needles from boiling alcohol," p. 120. Moureu and Valeur<sup>2</sup> represent sparteine as two quinuclidine residues joined by a  $-CH_2-$  group.

"Quinine is a diacidic base forming both 'neutral' and 'acid' salts. The 'neutral' salts (*e.g.*  $B_2.H_2SO_4$ ) are faintly alkaline to litmus and strongly alkaline to methyl orange. The alkaloid and its salts are intensely bitter to the taste. Three sulphates are known. Commercial quinine sulphate,  $B_2.H_2SO_4.8H_2O$  (or  $7H_2O$ ), is the 'neutral' sulphate, and is obtained by neutralising the alkaloid (lacmoid or cochineal as indicator) with dilute sulphuric acid and recrystallising from boiling water, from which it separates in bulky masses of colourless, glistening needles which effloresce and lose their lustre on exposure to dry air, forming the dihydrate,  $B_2.H_2SO_4.2H_2O$ ; m.p. 205°, which also results when the salt is exposed over sulphuric acid; at 100° it becomes anhydrous and can be crystallised in this condition from boiling chloroform. The salt containing 7  $H_2O$  is sparingly soluble in water (1 in 720 at 25°, 1 in 30 at 100°), more soluble in alcohol (1 in 86 at 25°, 1 in 9 at 60°), readily soluble in a mixture of chloroform (2 parts) with alcohol (1 part), and very soluble in dilute acids. The solution in water is scarcely fluorescent, but is markedly so in dilute sulphuric acid. The hydrated sulphate is laevorotatory,  $[\alpha]_D^{15} - 166.36^\circ$  in alcohol, or  $-233.75^\circ$  in the case of the anhydrous salt,  $-235^\circ$  in 1 per cent. sulphuric acid (Tutin). The acid sulphate,  $B.H_2SO_4.7H_2O$  (quinine disulphate), forms colourless, transparent, orthorhombic crystals, m.p. 160° (*decomp.*),  $\alpha_D - 159.1^\circ$  (Tutin), which effloresce in air and turn yellow on exposure to light. It is soluble in water (1 in 8.5 at 25°) or alcohol (1 in 18° at 25°) and sparingly so in ether (1 in 1770 at 25°) or chloroform (1 in 920 at 25°). The aqueous solution is acid to litmus, neutral to methyl orange, and markedly fluorescent. The so-called tetrasulphate,  $B.2H_2SO_4.7H_2O$ , forms colourless prisms, and is exceedingly soluble in water, much less so in alcohol.

"Quinine hydrochloride,  $B.HCl.2H_2O$ , closely resembles the neutral sulphate in appearance, and like it, effloresces in dry air, m.p. 158-160° (dried

<sup>1</sup> Valeur: *Compt. rend.*, 164, 818 (1917).

<sup>2</sup> *Compt. rend.*, 317, 194 (1903); 141, 117, 261, 328 (1905); 145, 815 (1907); 154, 309 (1912).

at  $100^{\circ}$ ),  $[\alpha]_D^{11} - 133.7^{\circ}$  in water (Oudemans),  $-155.8^{\circ}$  (Tutin), soluble in water (1 in 18 at  $25^{\circ}$ , alcohol (1 in 0.6 at  $25^{\circ}$ ), chloroform (1 in 0.8 at  $25^{\circ}$ ) and sparingly in ether (1 in 240 at  $25^{\circ}$ ). The aqueous solution is neutral to litmus and is not fluorescent except after the addition of sulphuric acid. The acid hydrochloride,  $B \cdot 2HCl$ , best obtained by treating a solution of the acid sulphate with barium chloride, crystallises in concentrically grouped needles and is very soluble in cold water (1 in 0.75). The hydrobromide,  $B \cdot HBr \cdot 2H_2O$ , resembles the hydrochloride, m.p. commences at  $152^{\circ}$  and ends at  $200^{\circ}$ , soluble in water (1 in 55 at  $15^{\circ}$  Hesse), alcohol (1 in 0.67 at  $25^{\circ}$ ), less so in chloroform or ether. The aqueous solution is neutral and fluoresces only on addition of sulphuric acid," p. 132.

"Quinidine is alkaline in solution and behaves as a diacidic base forming two series of salts. The neutral sulphate,  $B_2H_2SO_4 \cdot 2H_2O$ , crystallises from hot water in colourless prisms, soluble in water (1 in 98 to 100 at  $15^{\circ}$ , or 1 in 7 at  $100^{\circ}$ ), more so in alcohol or chloroform, and scarcely in ether. It is dextrorotatory,  $[\alpha]_D + 184.17^{\circ}$  in chloroform. The acid sulphate,  $B \cdot H_2SO_4 \cdot 4H_2O$ , forms hair-like, colourless needles, soluble in 8.7 parts of water at  $10^{\circ}$ . The neutral hydrochloride,  $B \cdot HCl \cdot H_2O$ , m.p.  $258^{\circ} - 259^{\circ}$  (*dry, decomp.*),  $[\alpha]_D^{20} + 200^{\circ}$  in water, forms asbestos-like prisms, readily soluble in alcohol, sparingly in water, chloroform, or hydrochloric acid. The neutral hydriodide,  $B \cdot HI$ , is deposited as a crystalline powder when potassium iodide is added to a neutral aqueous solution of a quinine salt, and is the form in which the alkaloid is usually isolated and estimated, since it is less soluble in water (1 in 1250 at  $15^{\circ}$ , 1 in 1270 at  $10^{\circ}$ ) than the hydriodides of the other cinchona alkaloids," p. 136.

"Cinchonine behaves as a diacidic base, and gives two series of salts. The neutral sulphate,  $B_2 \cdot H_2SO_4 \cdot H_2O$ , forms rhombic crystals, m.p.  $200^{\circ}$  (*dry, decomp.*), readily soluble in 80 per cent. alcohol (1 in 5.8 at  $11^{\circ}$ ), moderately so in water (1 in 65.5 at  $13^{\circ}$ ),  $[\alpha]_D + 193.29^{\circ} - 0.374c$ , where  $c$  = grammes of alkaloid per 100 c.c. of 97 per cent. alcohol, or  $+133^{\circ}$  in chloroform. The acid sulphate,  $B \cdot H_2SO_4 \cdot 4H_2O$ , colourless octahedral crystals readily soluble in alcohol (1 in 0.9 at  $14^{\circ}$ ), or water (1 in 0.46 at  $14^{\circ}$ ). The neutral hydrochloride,  $B \cdot HCl \cdot H_2O$ , m.p.  $217^{\circ} - 218^{\circ}$  (*dry*), forms monoclinic crystals, soluble in 22 parts of cold water or 1 part of cold alcohol,  $[\alpha]_D^{25} + 133^{\circ}$  in chloroform (Rabe)," p. 139.

"Cinchonidine crystallises in large trimetric prisms, m.p.  $207.2^{\circ}$  (Lenz),  $202.4^{\circ}$  (Hesse),  $[\alpha]_D - 107.9^{\circ}$  in alcohol 1 vol. chloroform 2 vols. (Lenz),  $-111^{\circ}$  in alcohol (Rabe); is sparingly soluble in water (1 in 5263 at  $11.5^{\circ}$  (Skraup)); more soluble in alcohol (1 in 303 of alcohol, sp.gr. 0.935 at  $11.5^{\circ}$  (Skraup), 1 in 16.3 of 87 per cent. alcohol at  $13^{\circ}$  (Hesse); or ether (1 in 1053 of dry ether at  $11.5^{\circ}$  (Skraup), 1 in 188 of ether, sp.gr. 0.72 at  $15^{\circ}$  (Hesse). Cinchonidine is not fluorescent in dilute sulphuric acid solution, and does not give the thalleioquin reaction. It is a diacidic base, and yields two series of salts. The neutral sulphate,  $B_2 \cdot H_2SO_4$ , m.p.  $205^{\circ}$  (*dry*) forms monoclinic prisms with  $6H_2O$  from cold water, or with  $3H_2O$  from hot water, and is soluble in alcohol (1 in 72 at  $25^{\circ}$ ), or water (1 in 63 at  $25^{\circ}$ ). The trihydrated sulphate is

official in the United States Pharmacopoeia. The acid sulphate,  $B.H_2SO_4.5H_2O$ , is easily soluble in water, whilst the tetrasulphate,  $B.2H_2SO_4.H_2O$ , dissolves slowly in water. The neutral hydrochloride,  $B.HCl.H_2O$ , m.p.  $242^\circ$  (dry),  $[\alpha]_D -117.6^\circ$  anhydrous salt,  $c = 1.214$  in water), forms monoclinic double pyramids, or silky prisms with  $2H_2O$ , from its saturated aqueous solution. The dry salt is moderately soluble in water (1 in 38.5 at  $10^\circ$ ), or ether (1 in 325 at  $10^\circ$ ), readily in chloroform. The acid hydrochloride,  $B.2HCl.H_2O$ , forms large monoclinic prisms very readily soluble in water or alcohol," p. 140.

Cinohotine, hydrocinchonidine, and hydroquinine are reduction products of cinchonine, cinchonidine and quinine respectively, and are consequently diacid bases. The neutral sulphate of cinchotine crystallizes with eleven of water, that of hydrocinchonidine with seven of water, and that of hydroquinine with six of water.

"Cupreine is a diacidic base and yields two series of salts: the neutral sulphate,  $B_2.H_2SO_4$ , colourless anhydrous needles, soluble in 813 parts of water at  $17^\circ$ ; the acid sulphate,  $B.H_2SO_4$ , crystallises in prisms and is soluble in 73.4 parts of water at  $17^\circ$ . On methylation cupreine is converted into quinine, but the latter on demethylation yields apoquinone, which is also formed when cupreine is heated with halogen acids," p. 147.

Among the plant alkaloids<sup>1</sup> which have two nitrogens in the molecule but only add one hydrogen chloride, we find: nicotine, nicotimine, strychnine, brucine, hypaphorine, harmine, and pilocarpine.

"The reactions [of nicotine] can be explained on the assumption that the side chain in nicotine consists of a series of three primary carbon atoms ending in a group,  $N.CH_3$ , and that since difficulty is experienced in reducing nicotine further than the hexahydro-derivative, the side-chain is closed, *i.e.*, that it is a *N*-methyl pyrrolidine," p. 55. The formula is believed to be

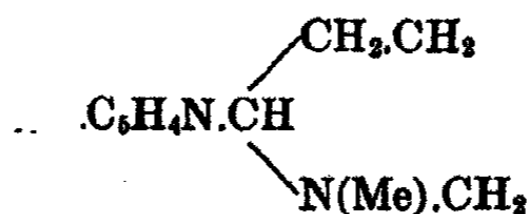

Since the two nitrogens are attached to the same carbon, only one hydrogen chloride should add on and only one does.

"According to Pictet<sup>2</sup> nicotimine does not contain a pyrrole nucleus and is probably represented by the following formula, which is that formerly assigned to nicotine, *viz.*, 2-piperidyl-3-pyridine," p. 59.

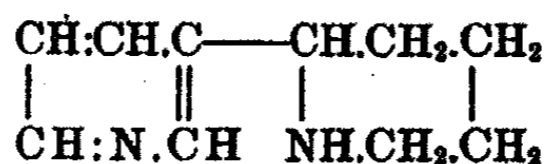

With this formula nicotimine must add on two hydrogen chlorides. Consequently, either the formula is wrong or nicotimine must be a diacid base.

<sup>1</sup> Henry: "The Plant Alkaloids" (1924).

<sup>2</sup> Ann., 244, 388 (1906).







4. Hydrazine adds two hydrogen chlorides, the alkyl hydrazines are still more basic. Owing to the negative phenyl group, phenyl hydrazine only adds one hydrogen chloride.

5. Urea adds but one hydrogen chloride because the two nitrogens are attached to the same carbon. There is some evidence that dipropyl urea adds two hydrogen chlorides and that tetraphenyl urea adds none.

6. It seems certain that the carbamide formula does not describe the behavior of solid urea.

7. Since biuret only adds one hydrogen chloride, we must write the formula as having three imide nitrogens with the hydrogen chloride adding to the middle one.

8. With succinimidine the first hydrogen chloride adds to the middle nitrogen and consequently no more can add.

9. Diacetyl urea, barbituric acid, parabanic acid, dialuric acid, and alloxan have two sets of diketo linkages and therefore do not add hydrogen chloride.

10. Uramil adds one hydrogen chloride, as it should; but uracil also adds one hydrogen chloride, which means that the ordinary formula of the organic chemists is wrong. Four alternative ones were suggested, not containing the ethylene linkage.

11. Antipyrin only adds one hydrogen chloride because the two nitrogens are attached to the same carbon.

12. Nicotine, cuscohygrine, sparteine, quinine, quinidine, cinchonine, cinchonidine, cinchotine, hydrocinchonidine, hydroquinine, and cupreine have two nitrogens apiece in the molecule and add two hydrogen chlorides apiece—as they should.

13. Nicotine, nicotimine, strychnine, brucine, hypaphorine, harmine, and pilocarpine have two nitrogens apiece in the molecule; but each adds only one hydrogen chloride. Nicotine and pilocarpine have the two nitrogens attached to the same carbon; strychnine, brucine, and hypaphorine have one nitrogen already in the pentavalent state; harmine has the two nitrogens linked together. In the case of nicotimine either the formula or the basicity is wrong.

14. The general conclusions which form the working hypothesis have proved helpful in the study of compounds containing two nitrogen atoms in the molecule.

*Cornell University.*

9A-2112 13-293

## AN AUTOMATIC THERMOREGULATOR\*

BY JAMES A. BEATTIE AND DAVID D. JACOBUS

In the course of a study of the temperature scales of the gas and platinum resistance thermometers, it became necessary to construct thermostats whose temperatures could be maintained at any desired value from 0° to 450°C and automatically regulated with an allowable variation of approximately  $\pm 0.001^\circ\text{C}$  for long periods of time. This result was realized by use of large, well-stirred liquid baths in conjunction with the thermoregulator described below, which is a further development of that used by Roebuck<sup>1</sup> and modified by Smith.<sup>2</sup>

In outline the method used is as follows: A flat type of platinum resistance thermometer, called the control thermometer, is placed in the bath to be regulated and its resistance balanced on a Wheatstone bridge which is connected to a galvanometer in the usual manner. A beam of light is reflected from the galvanometer mirror on to one of two photoelectric cells, whose change in resistance varies the grid potential of a three-electrode vacuum tube sufficiently to operate a sensitive relay, which in turn operates the relay that controls the regulating current in the bath heaters.

### The Bath

The bath, which will be described in detail elsewhere, is shown diagrammatically in Fig. 2. An iron vessel 15 inches in diameter and 30 inches deep is surrounded by 8 inches of insulation which also extends about 6 inches above its upper edge. This vessel has a tight fitting steel cover from which are suspended three shafts, with propeller-type stirrers, each enclosed in a steel tube  $2\frac{3}{4}$  inches in diameter. The shafts are geared together at the bottom and one of them projects through the cover and is rotated at about 1700 revolutions per minute by an electric motor. The bath fluid, which is either mineral seal oil, heavy cylinder oil, or an eutectic mixture of lithium, sodium and potassium nitrates, is projected downward through each of the three stirrer tubes, and is thus very thoroughly and rapidly mixed.

Sufficient electrical energy is introduced through heaters wound on the outside of the iron vessel to raise the temperature of the bath to within 2° to 3°C of that at which it is desired to operate. The final heating and the regulation is obtained by use of three internal heaters, placed one in the top of each stirrer casing. These heaters are similar in construction<sup>3</sup> to the control thermometers. They each have a resistance of about 70 ohms and are connected in parallel with each other and in series with an adjustable resistance so that any amount of electrical energy up to 200 watts may be introduced.

\* Contribution from the Research Laboratory of Physical Chemistry of the Massachusetts Institute of Technology, No. 238.

<sup>1</sup> Roebuck: Proc. Am. Acad. Arts Sci., 60, 537 (1925).

<sup>2</sup> Smith: Mechanical Engineering, 48, 153 (1926).

### The Control Thermometers

The platinum-resistance control thermometers are of the calorimetric type similar to those developed at the Bureau of Standards.<sup>3</sup> Some slight modifications in their construction have been introduced and these will be described elsewhere. The resistance of each is 25 ohms at 0°C. Two such thermometers, connected in series as indicated in Fig. 1, are placed in the bath (see Fig. 2).

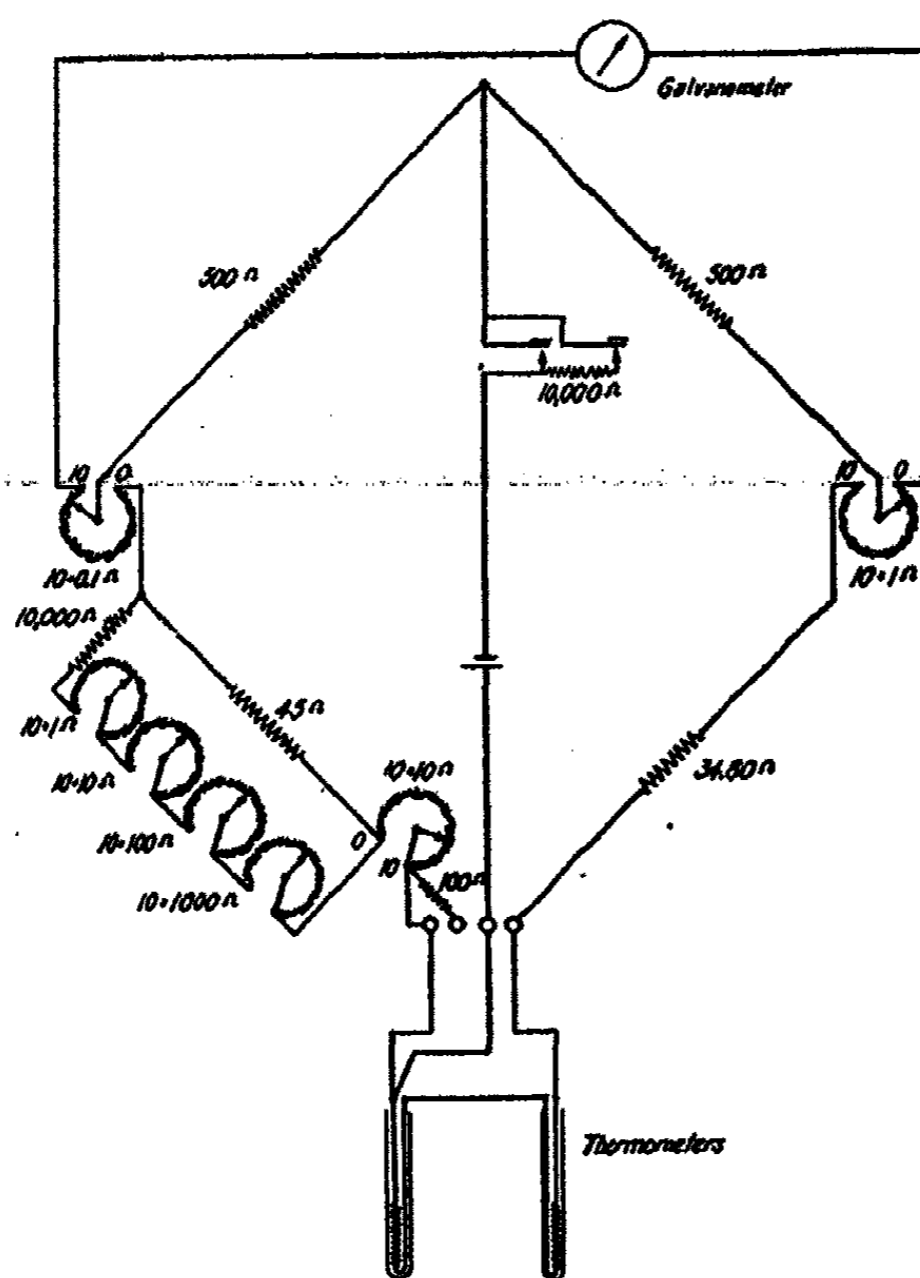

FIG. 1  
Diagram of Resistance Bridge

### The Resistance Bridge

The bridge, Fig. 1, is an adaptation of the Mueller<sup>4</sup> resistance thermometer bridge. In order that the temperature of the bath may be made any desired value, the bridge is arranged to give settings to approximately 0.00001 ohms which corresponds to about 0.0001°C in a 25 ohm platinum resistance thermometer. Moreover, since the bridge is not to be used for reading resistances, the lower decades are constructed with one shunt resistance which reduces the cost of manufacture. The total range of the bridge is 210 ohms.

<sup>3</sup> Sligh: Sci. Papers Bur. Standards, 17, 49 (1922).

<sup>4</sup> Waidner, Dickinson, Mueller and Harper: Bull. Bur. Standards, 11, 571 (1915); Mueller: 13, 547 (1917).

The ratio arms and the method of inserting the 1 and 0.1 ohm decades are the same as those used by Mueller. For the lower decades a 45 ohm resistance is shunted with a fixed 10,000 ohm resistance and four decades  $10 \times 1$ ,  $10 \times 10$ ,  $10 \times 100$ , and  $10 \times 1000$ , all connected in series. The maximum variation of this shunted circuit is 0.107 ohms, and the values of the successive decades are roughly 0.01, 0.001, 0.0001 and 0.00001 ohms. The exact values vary from about twice to one-half these values depending on the total resistance in the shunt circuit. However this is not disadvantageous as the bridge is used only for balancing the resistance of the control thermometers. A ten ohm decade and a 100 ohm coil are inserted as shown.

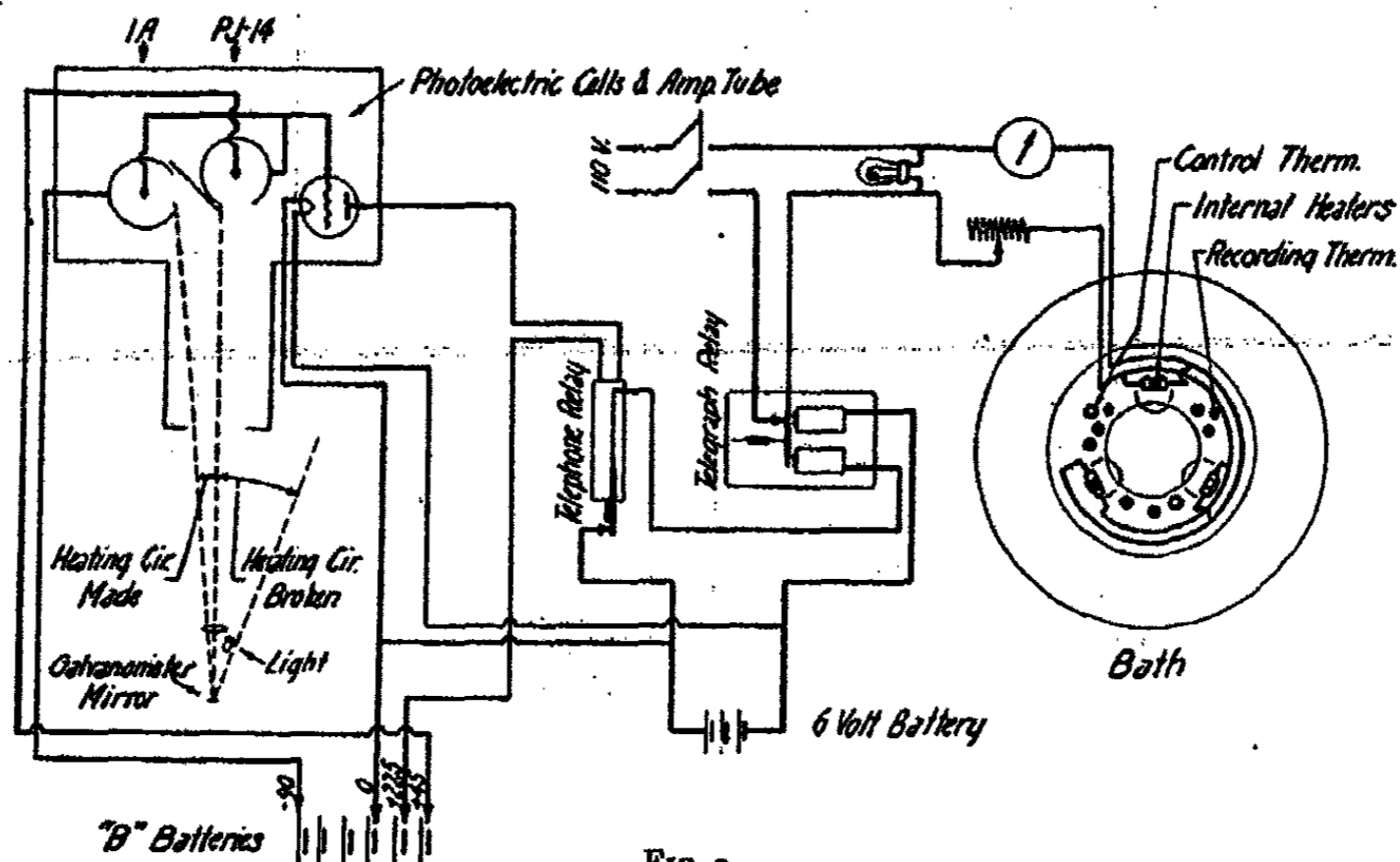

FIG. 2  
Diagram of Control Circuit

The bridge was manufactured by Leeds and Northrup and has given very satisfactory service. When in use, it is thermostated at  $30^{\circ}\text{C} \pm 0.01^{\circ}$  in a stirred, heated, and regulated bath of government medium oil. Thermostating the bridge is essential if constancy of setting is to be maintained for a considerable period of time.

#### The Galvanometer

Two types of galvanometers have been used: the Leeds and Northrup Type HS, and the Type R. The latter instrument has a heavier suspension system and therefore requires less frequent adjustment for zero shift. This is advantageous when temperature regulation for long periods of time is desired. But the periodic variations in the bath temperature are about 50% greater when the less sensitive galvanometer is used.

#### The Control Circuit

A diagram of the control circuit is shown in Fig. 2. A 6-8 volt, 21 candle power automobile headlight lamp is mounted approximately seven inches from the galvanometer mirror. The light reflected from the mirror passes through a lens system, thus focusing an image of the filament of the lamp

in the plane of the photoelectric cells which are at a distance of fourteen feet from the galvanometer. To eliminate the time consuming process of making small adjustments in the position of the galvanometer mirror, the lamp is mounted so that, within a limited range, it can be moved in any direction.

Two photoelectric cells, one a vacuum type PJ-14 made by the General Electric Company and the other an argon-filled type 1 A made by the Western Electric Company, together with a UX-171 amplifying tube are enclosed in a light-tight box. The side of the box facing the galvanometer has a projection about two feet long with a slot 3 inches by  $\frac{3}{4}$  inches at the end to admit the light from the galvanometer mirror. The photoelectric cells are arranged as shown in the diagram and a thin metallic mirror is so placed that the light beam either falls directly on one of the cells or passing over the thin edge of the mirror is reflected on to the other cell.

When the cell to the right becomes conducting due to the action of light it places a positive bias on the grid of the amplifying tube and when the cell to the left becomes conducting it places a negative bias on the grid. It is essential that the leads connecting the cells to the grid of the tube be as short as possible and well insulated. The primary of a B 108 telephone relay is placed in the plate circuit of the amplifying tube, and its contacts are connected in series with a six volt battery and the primary of a telegraph relay. The contacts of this latter relay make and break the regulating heating circuit. A lamp in parallel across this circuit indicates whether the bath is being heated or cooled.

The values of the "B" voltages given in the diagram are the most satisfactory for the types of photoelectric cells used; if other cells are employed it may be necessary to determine by trial what potentials are best. The voltages used are such that when neither cell received light from the galvanometer mirror, the plate current of the amplifying tube is sufficient to cause the contacts of the telephone relay to close. The movable arm of the telegraph relay is thus pulled towards the magnets, and the contacts are so wired that this causes the regulating heating circuit to be broken.

#### Operation of the Control Circuit

As the temperature of the bath drops, the galvanometer mirror moves so that the beam of light is reflected on to the photoelectric cell to the left. This places a negative bias on the grid of the amplifying tube thus reducing the plate current to a value which allows the contacts in the telephone relay to open, which in turn causes the movable arm of the telegraph relay to move away from the magnets thus closing the heating circuit in the bath. As the bath temperature increases the beam of light from the galvanometer mirror moves to the right and when it has passed over the thin edge of the metallic mirror it falls on to the other photoelectric cell which places a positive bias on the grid thus causing the heating circuit to be broken. The energy introduced through the internal heaters should be kept as small as possible in order that the heating should not take place too rapidly. In the bath used it was found that about 50 watts gave good results.

The operation of the photoelectric cells is very rapid. A motion of the beam of light which is hardly perceptible will cause the heating circuit to be made or broken at once. When the bath is regulating, a shift in the bridge setting corresponding to  $0.0005^\circ$  will cause the relay to operate. The use of two photoelectric cells causes the action of the circuit to be very positive. After the automatic regulation has been put into operation, the temperature of the bath has never varied sufficiently to cause the beam of light to move off of the photoelectric cells. If the beam were moving to the left, this would allow the bath to cool continually.

The bath can be rapidly heated by means of the external coils, through which five kilowatts may be introduced. When the temperature of the bath approaches the value at which it is desired to operate, the external heating current is adjusted by means of an induction voltage regulator to a value, as determined by preliminary runs, which will itself keep the bath about  $2^\circ$  to  $3^\circ\text{C}$  below the operating temperature. The internal heaters are then connected and the bridge set. As the operating temperature is approached the galvanometer circuit is closed from time to time first through the 10,000 ohm resistance and finally through zero resistance. The regulation then becomes automatic. It is thus no trouble to reproduce any temperature once the current in the external heaters and the bridge setting is known for that value.

#### Performance

The bath has been regulated automatically from room temperature to  $450^\circ\text{C}$  for periods of eight hours without any adjustment or with infrequent adjustments of the lower decades of the resistance box. The variation in temperature as read on a series of five flat type thermometers placed at various points in the bath was  $\pm 0.001^\circ\text{C}$ . There were no sharp shifts in temperature. By reading the maximum and minimum variations in the property of any system immersed in the bath, it should be possible to determine this property with an accuracy in which the uncertainty contributed by temperature variations does not exceed  $0.0005^\circ\text{C}$ .

#### Regulation of Air Baths

The automatic regulation of the temperatures of electrically heated furnaces up to  $1200^\circ\text{C}$ , with a constancy of  $0.1^\circ$  throughout the furnace cavity, has been described by Roberts.<sup>5</sup> Its basic feature is the use of the heating coil of the furnace as a resistance thermometer, although the possibility of the use of an auxiliary coil which acts as a resistance thermometer was considered.

The method of control described in the present paper has been used to regulate the temperature of a platinum-wound air furnace. The control thermometer was placed in the furnace; and the contacts of the telegraph relay used to shunt a resistance which was connected in series with the wind-

<sup>5</sup> Roberts: *J. Opt. Soc. America*, 11, 171 (1925). See also White and Adams: *Phys. Rev.*, (2), 14, 44 (1919).

ing of the furnace. By proper adjustment of external resistances sufficient energy was introduced to raise the temperature of the furnace to within several degrees of the desired value, and the final heating was accomplished by shorting a part of this resistance.

The object which it was desired to keep at constant temperature was surrounded by a cylinder of silver about  $3/16$ " thick in order to smooth out temperature variations. The control thermometer was placed outside of the cylinder, and the temperature of the object measured with a thermocouple inside the cylinder and adjacent to the sample. The variation in temperature indicated by this thermocouple was  $\pm 0.05^{\circ}\text{C}$ . With a better designed furnace the regulation could no doubt be made considerably better.

#### Summary

An automatic thermoregulator is described which has kept the temperature of a stirred liquid bath for long periods of time at any desired value from room temperature to  $450^{\circ}\text{C}$  with a variation of  $\pm 0.001^{\circ}\text{C}$ . The method can also be used to regulate the temperature of air baths.

## THE ADSORPTION OF THE VAPORS OF METHANE AND ITS CHLORINE DERIVATIVES BY ACTIVATED CHARCOAL<sup>1</sup>

BY J. N. PEARCE AND H. F. JOHNSTONE

The hypothesis of molecular attraction is a natural corollary of the theory of the discontinuous nature of matter. If there were no other justification for this hypothesis than the force which exists between two neutral bodies, and which for greater distances obeys Newton's law of gravitation, this force would become noticeable at distances as small as those that exist between molecules. For such small distances it has been shown that Newton's law does not hold, but that the attraction is even much greater than that required by it. Furthermore, the theory of atoms as systems of electrical charges impels the idea of some kind of force existing between the individual particles. In addition to the force of attraction we must hypothecate a force of repulsion, otherwise the attractive force would cause all matter to shrink to a point. If we assume with Eucken<sup>2</sup> that both forces are additive at every point, then without further assumptions it can be concluded that the repulsive force decreases more rapidly with increasing distance than does the attractive force. At a definite distance between the particles the two forces will exactly compensate each other. The body will then be in equilibrium and its volume will correspond to the normal volume. At smaller distances the repulsive forces outweigh those of attraction. The reverse is true for distances which are greater than those corresponding to normal conditions. In the interior of a solid therefore the resulting force is zero. At the surface, however, since the repulsive force falls off so much more rapidly than does the attractive force, the resulting force is real and is directed toward the interior. In the light of most modern views this resultant force is the basis of such phenomena as adsorption, surface tension, etc.

Various views have been suggested as to the nature and distribution of these surface forces. According to Langmuir<sup>3</sup> they are finite and discontinuous, that is, they originate only at definite "adsorption centers," the positions of which depend on the space lattice of the adsorbent, and extend outward over a definite distance which at most is of the order of molecular thickness. There is at the surface of a solid an unbalanced force due to the existence of the primary and secondary valences of the surface atoms. When the gas molecules are adsorbed by crystals they take up definite positions on the surface and form a continuation of the lattice structure. With Langmuir true adsorption is simply a chemical phenomenon in which the primary and secondary valences are saturated.

<sup>1</sup> From a dissertation submitted by H. F. Johnstone to the Faculty of the Graduate College of the State University of Iowa in partial fulfillment of the requirements for the degree of Doctor of Philosophy, August, 1926.

<sup>2</sup> Eucken, Jette and LaMer: "Fundamentals of Physical Chemistry," 108 (1925).

<sup>3</sup> Langmuir: J. Am. Chem. Soc., 39, 1848 (1917); 40, 1361 (1918).



Taylor<sup>4</sup> has advanced a theory of adsorption to explain catalytic activity. While he assumes with Langmuir an unbalanced force at the surface of a solid, he develops the idea of the force in a somewhat different way. Thus, the atoms on a plane surface of a solid are saturated in three dimensions by the neighboring atoms; there is left one degree of unsaturation directed outward toward the gaseous phase. It follows then that those atoms which lie on an edge will have two degrees of unsaturation while those on a corner will possess three such degrees. The attractive force exerted by the atoms of the adsorbent upon the impinging gas molecules will therefore be greatest at the corners and least on the plane surfaces. Thus, points represent positions at which adsorption is most highly favored.

In a study of the adsorption of gases by oxide catalysts, Benton<sup>5</sup> distinguishes between primary and secondary adsorption. Primary adsorption is selective and is due to primary valence forces. The amount of gas adsorbed increases rapidly at low pressures and soon reaches a maximum saturation value. Secondary adsorption is exhibited by inert adsorbents like charcoal, mica and silica gel, where the tendency of the different gases to be held on the charcoal is of the same order as their boiling points or melting points. Secondary adsorption decreases continuously with increase in temperature and for any given temperature does not reach a saturation value until a high pressure is attained. In most cases both primary and secondary adsorption may occur at the same time.

A distinctly different view of the mechanism of adsorption is taken by Eucken,<sup>6</sup> Polanyi,<sup>7</sup> Jaquet<sup>8</sup> and others. They consider the adsorption forces as independent of the lattice structure of the adsorbent. At the surface of the solid there is a potential drop which is called the adsorption potential. This potential is exceedingly high near the surface and decreases to zero at the limit of the adsorption space. Eucken assumes that adsorption is due to the formation of a highly compressed layer of gas under the influence of molecular attraction forces. Basing his views largely on the fact that the noble gases are about as strongly held on charcoal as are polyatomic gases of the same boiling point, he is inclined to the view that the adsorption of gases by charcoal is due to adsorption forces which are of a physical rather than of a chemical nature, just as we are accustomed to consider the cohesion of argon atoms in the solid and liquid state as due to physical force. Between the adsorption force which attracts the molecules to the surface and the thermal pressure which hurls the molecules chaotically about among themselves a sedimentation equilibrium must be established. This is characterized by the fact that in each stratum of the gas the attractive force is equal to the thermal pressure. In this way there is formed upon the surface of the ad-

<sup>4</sup> Taylor: *J. Phys. Chem.*, 30, 145 (1926).

<sup>5</sup> Benton: *J. Am. Chem. Soc.*, 45, 887, 900 (1923).

<sup>6</sup> Eucken: *Verh. deutsch. physik. Ges.*, 16, 345 (1924); *Z. Elektrochemie*, 28, 6 (1922).

<sup>7</sup> Polanyi: *Ber. deutsch. physik. Ges.*, 16, 1012 (1914); *Verh. deutsch. physik. Ges.*, 18, 55 (1916); *Z. Elektrochemie*, 26, 370 (1920).

<sup>8</sup> Jaquet: *Fort. der Chemie*, 1925, 18.

sorbent a miniature atmosphere whose density outward decreases more or less rapidly according to the behavior of the adsorbing force. To explain the nature of the attracting force Polanyi assumes that on close approach to each other the molecules are deformed in such a way by displacing the nuclei that they not only attract each other but are also attracted by the adsorbing surface. Surrounding each adsorbent there is a characteristic adsorption space within which the adsorption forces are active. The adsorption potential and the density of the adsorbed gas are greatest at the surface of the adsorbent and both decrease continuously to the edge of the adsorption space. While Polanyi does not believe that the potential decreases asymptotically with the distance from the surface and thus reaches zero only at infinity, his view differs from that of Langmuir in supposing that the adsorptive force extends over a distance greater than that of molecular diameters and becomes zero at a finite distance. More recently Coolidge<sup>9</sup> has shown that the idea of a vanishing potential at a finite distance is not inconsistent with the known laws of forces between bodies. That for a concave adsorbing surface the volume of the adsorption space is a rapidly converging function of the distance and the ratio of the potential to the volume is infinite. Thus, the potential vanishes at only a short distance from the adsorbent.

The similarity of the forces of attraction between two molecules and those between a molecule and an adsorbent seems to predict some relation between the constant  $a$  of van der Waals' equation of state for gases and the adsorption potential which may be calculated from the adsorption isotherms. Polanyi has found this to be true and he has shown that for many gases the adsorption potential existing at the surface of the adsorbent is proportional to the square root of the constant  $a$ .

While much excellent work has been done on the adsorption of gases and vapors by charcoal, the work as a whole seems to offer little as a basis of comparison. The reason for this is entirely obvious. The samples of charcoal used by the many investigators have been prepared from various sources and by various methods. In no two cases, perhaps, do the charcoals used even approximate the same activity or the same mineral content. Aside from the ordinary gases the vapors which have been used might appear to have been picked at random. For this reason we know relatively little, if anything, of the influence of molecular structure or of the influence of the chemical or electrical nature of the constituent atoms or their groupings upon adsorption magnitudes. All of these factors must obviously affect the magnitude of adsorption. To answer these questions we have begun a systematic study of the adsorption of a large number of vapors of different types under definite standard reproducible conditions. The investigation involves the determination (1) of the adsorption isotherms and the study of the isobaric and isosteric relations resulting therefrom: (2) the relation between the magnitude of adsorption and the physical properties of the adsorbed gases and vapors, such as their boiling points, molecular volumes, surface

<sup>9</sup> Coolidge: J. Am. Chem. Soc., 48, 1795 (1926).

tension, compressibility, etc.; (3) the relation between the magnitude of adsorption and chemical constitution, particularly with respect to the effect of substituent groups, their electroaffinities and their atomic arrangement within the molecule. These relations are being studied from the standpoint of homologous series. The present work involves the study of the adsorption equilibria between an activated charcoal and the vapors of methane and its chlorine derivatives.

#### Materials

The charcoal used in these experiments was obtained in considerable quantity from the National Carbon and Carbide Corporation and it was prepared under the direction of Dr. N. K. Chaney. To him and to the company we wish to acknowledge our appreciation for the great service rendered. It is a coconut charcoal which has been activated by steam, treated with acid to remove mineral matter and then washed until acid-free. Repeated determinations show the ash content to be 0.28 by weight, a much smaller percent than that found in the ordinary gas-mask charcoal. The loss in weight on outgassing and the density were carefully determined by approved methods. These were used in calculating the actual weight of the adsorbent and the volume of the "dead space." The size of the granules ranged from 10 to 20-mesh.

*Methane.*—The methane was prepared by treating a zinc-copper couple with a pure alcoholic solution of methyl iodide. It was purified by bubbling through water and concentrated sulphuric acid, and then passed through tubes containing anhydrous  $\text{CaCl}_2$  and  $\text{P}_2\text{O}_5$ . Finally, the last traces of condensable gases were removed by passing through a trap immersed in liquid air. From this the gas was passed directly into the adsorption apparatus. The air in the generating apparatus and in the drying train had been removed by repeated evacuation and flushing out with the methane evolved. The vapor pressure of the methane at the temperature of liquid air was found to be 98.5 mm., a value which is in close agreement with that found in the literature.

The methyl chloride was prepared by passing a stream of dry hydrogen chloride gas into absolute methyl alcohol in the presence of anhydrous zinc chloride. The gas was purified, dried and collected in small tubes. The methylene chloride, chloroform, and carbon tetrachloride of pure grade were further purified by washing, then dried and fractionally distilled several times. The tubes containing these liquids were sealed directly to the adsorption apparatus when used. After transfer to the storage bulb of the adsorption apparatus the liquid was boiled under reduced pressure to remove all traces of air.

#### Apparatus and Procedure

The adsorption apparatus was somewhat similar to that employed by Coolidge<sup>10</sup> in his study of the adsorption of vapors by charcoal. Two modifications were required for the admission of the pure vapors under high pres-

<sup>10</sup> Coolidge, J. Am. Chem. Soc., 46, 596 (1924).

tures and for the attainment of high equilibrium pressures. The apparatus was constructed entirely of pyrex, without stopcocks, rubber connections, or ground-glass joints so that the vapors never came in contact with any materials except glass and mercury. The necessary calibrations were made by measuring the pressure exerted by a known volume of air admitted from a carefully calibrated gas burette.

The entire apparatus was assembled in a large double-wall air-bath, provided with two glass doors which permitted readings to be made without disturbing the temperature within. The temperature of the bath was kept sufficiently high so that no condensation of the vapors in the tubes could occur, except at high pressures. The bath was heated by a series of lamp banks placed within the walls. The temperature was maintained constant by means of a powerful fan which drew the air upward through the top, then forced it down between the walls over the lamps where it finally entered the chamber through large holes at the bottom. An auxiliary fan placed within the bath insured thorough agitation of the air inside. A mercury regulator attached to a four foot tube of mercury maintained the temperature to within  $\pm 0.02^\circ$ . When adsorption measurements were made at other temperatures than that of the bath the charcoal bulb was immersed in liquid air, liquid ammonia, or in the vapor of a boiling liquid.

The charcoal was outgassed before each run at  $525^\circ$  until the McLeod gage showed a pressure of less than  $5.10^{-6}$  mm. On cooling the bulb slightly the pressure dropped rapidly until it could no longer be read on the gage. A Cenco Hyvac pump in series with a Langmuir mercury vapor condensation pump was used in the evacuation process.

In their determination of the heats of adsorption of vapors containing a halogen atom Lamb and Coolidge<sup>11</sup> have found that discrepancies occur in the results, if the experiment is repeated with the same sample of charcoal. In his later work with  $\text{CCl}_4$  and  $\text{CHCl}_3$  Coolidge<sup>10</sup> has found that less vapor is adsorbed, if the charcoal has been previously in contact with the vapors. This impairment of the efficiency of the adsorbent was marked and seemed to be about the same at all temperatures. We have redetermined, in duplicate, the isotherms for the adsorption of  $\text{CHCl}_3$  by our charcoal at  $46.2^\circ$  and  $61.0^\circ$ . We also have found that charcoal which has been saturated with  $\text{CHCl}_3$  does not again regain its former activity by prolonged heating and outgassing. The second isotherm thus obtained for each temperature lies well below the first. To avoid the vitiating effects of the organic chloride vapors we have employed a fresh sample of charcoal for each isothermal series. In this way the original rigid conditions of a standard adsorbent are more strictly adhered to.

### Results

The adsorption of methane was determined at seven temperatures between the temperature of liquid air and  $100^\circ$ . The lowest isotherm cannot be used for quantitative comparison, since the temperature was neither definitely

<sup>11</sup> Lamb and Coolidge: *J. Am. Chem. Soc.*, 42, 1146 (1920).

known nor was it absolutely constant during the run. This isotherm is of interest, however, in that it shows the high adsorption of methane at this temperature. At  $100^{\circ}$  the volume of methane adsorbed was so small that it did not appear advisable to proceed to higher temperature.

For methyl chloride nine adsorption isotherms were determined within the temperature range from  $-32^{\circ}$  to  $237^{\circ}$ . The curves for this vapor are perhaps the most theoretically instructive of any of the vapors studied. This is because the adsorption is large enough to be easily measured; there is no danger of condensation in the tubes of the apparatus; except for methane, the gas laws are more nearly obeyed by the vapor; the temperature and pressure ranges are the greatest; and, finally, there is no evidence of decomposition until the temperature of  $237^{\circ}$  is reached. Even at this temperature the appearance of a slow decomposition was not observed until the pressure had reached about 300 mm. From this point on the pressure began to rise continually as soon as the vapor was admitted to the charcoal; in no case was the attainment of equilibrium possible.

The adsorption of the vapor of methylene chloride was studied at eight temperatures between  $-31.5^{\circ}$  and  $184^{\circ}$ . At the latter temperature the decomposition of the vapor became evident by the gradual increase in pressure. Only at  $-31.5^{\circ}$  and  $0^{\circ}$  was it possible to attain pressures corresponding to that of the saturated vapor.

For chloroform and carbon tetrachloride the isotherms range from  $0^{\circ}$  to  $100^{\circ}$  and from  $-31.5^{\circ}$  to  $64^{\circ}$ , respectively. The former decomposed fairly rapidly at  $143^{\circ}$ , a fact which Coolidge has previously stated. After determining the  $80^{\circ}$ -isotherm for carbon tetrachloride we found that the shape of the curve was slightly different from that of the isotherms at lower temperatures. Later, while studying the isotherm at  $100^{\circ}$  we noticed that if the pressure were measured over a period of six to eight hours, instead of the usual two-hour interval, a slight increase in pressure became evident some time after the initial decrease which follows the admission of the sample of the vapor. In twenty-four hours this increase amounted to several mms., and when after several days the system showed no evidence of attaining pressure equilibrium the run was abandoned. When the charcoal was removed from the bulb its surface was found to be covered with fine white crystals which under the microscope were highly reflective to light. We repeated the  $80^{\circ}$ -isotherm, allowing several days between each addition of vapor. In no case was equilibrium attained, but always a constant increase in pressure was observed. After ten days the charcoal was again found to be covered with white crystalline microscopic specks. From this we may conclude that carbon tetrachloride decomposes in the presence of charcoal at temperatures even as low as its boiling point. Coolidge<sup>10</sup> has reported that no decomposition was observed with this vapor until he reached  $143^{\circ}$ , and he gives the data for the  $100^{\circ}$ -isotherm. It would be easily possible that the decomposition at  $100^{\circ}$  would pass unobserved, if the adsorption measurements were made too rapidly. In the hope of obtaining more information concerning the decomposition and its products a large quantity of charcoal was evacuated at  $525^{\circ}$

and then opened to air-free carbon tetrachloride. The temperature of the charcoal was kept at  $125^{\circ}$  for three weeks. When the bulb was finally opened large volumes of chlorine and hydrogen chloride gas were given off. A sample of the charcoal was then extracted with ether and a second sample with alcohol, but neither extraction gave a sufficient amount of the residue to work with. These facts give us, in part at least, an explanation for the effect of organic chlorides upon the adsorptive properties of charcoal. It is possible that an immeasurably slow decomposition may take place at still lower temperatures. In the subsequent outgassing of the charcoal at  $525^{\circ}$  any vapor adhering to the charcoal is rapidly decomposed. One of the products of the decomposition is undoubtedly an inactive form of carbon which prevents the re-activation of the charcoal by heating and outgassing.

In order to compare most effectively the data obtained for the various vapors, to estimate the magnitude of the experimental errors and to test equations which have been presented to express the various adsorption relations, extensive use has been made of the graphic method. When possible, systems of graphic representation are so chosen that the observed points lie as nearly as possible on straight lines.

It may be noted in the following cuts that, in general, the observed values fall on smooth curves for each of the systems studied. At low pressures however, small errors, which are beyond the limits of experimental measurement, are greatly magnified when plotted on the logarithmic scale. The errors at high pressures are in all cases less than one percent. Furthermore, errors due to inaccuracy in measuring vapor volumes, while not always compensating, are never cumulative.

A comparison of the adsorption values for the vapors of methane and its chlorine derivatives show clearly the effect of the chlorine atom on the properties of the adsorbed vapor molecules. This effect is manifested (1) by an increase in the cohesive properties of the molecules, tending to increase adsorption; and (2) by an increase in the volume of the molecules, which, in turn, because of their greater covering power, tends to diminish the total number of molecules adsorbed. These properties cause the data obtained to appear to agree apparently with two general adsorption relations which at first sight seem to be directly opposed the one to the other. In studying the adsorption of a large number of gases Dewar<sup>12</sup> noted that, in general, that gas which has the highest boiling point exhibits the greatest adsorption on any adsorbent. On the other hand, Schmidt and Hinteler<sup>13</sup> have found that for the adsorption of  $H_2O$ ,  $C_6H_6$ ,  $CS_2$ ,  $CHCl_3$  and other vapors by charcoal the adsorption values at saturation are approximately inversely proportional to the molecular volumes of the liquids at their respective boiling points. Now, for any homologous series of related compounds the boiling points increase with increase in the molecular weight, a fact which may be attributed to the increase in the cohesive properties, due largely to the added mass of

<sup>12</sup> Dewar: *Chem. News*, 94, 174, 185 (1907); 97, 4, 16 (1908).

<sup>13</sup> Schmidt and Hinteler: *Z. physik. Chem.*, 91, 103 (1916).

the atoms. Furthermore, for an homologous series of related compounds the molecular volume also increases with the molecular weight. The apparent discrepancy between the rule of Dewar and that of Schmidt and Hinteler disappears when we remember that Dewar worked with gases with very low boiling points and that in practically no case did he even approach saturation. His isotherms were often above the critical temperature of the adsorbed gas. The two general laws are applicable to entirely different portions of the isotherms and therefore are not contradictory.

That our results agree with both of the rules just discussed is not surprising when we consider the role played by the chlorine atom in the adsorption process. Chlorine is an element which possesses a large number of primary valence electrons. We might expect, therefore, that the residual valence is large. Chlorine atoms, also, are usually considered as highly electronegative and an increase in their number by substitution must increase the electronegativity of the molecule. We may reasonably suppose, therefore, that of the three kinds of atoms in the series, methane and its chlorine derivatives, the chlorine atom would be the one that is most strongly attracted by the carbon atom in the surface lattice of the adsorbent.

The effect of the chlorine atom on the adsorptive properties of vapors seems thus to be perfectly definite. At low pressures and low concentrations, we would expect the adsorption of  $\text{CCl}_4$  to be the greatest because of the greater attraction of the four chlorine atoms by the adsorbent. In this range the order of increasing adsorption would be  $\text{CH}_4$ ,  $\text{CHCl}_3$ ,  $\text{CH}_2\text{Cl}_2$ ,  $\text{CHCl}_2$ ,  $\text{CCl}_4$ . As the concentration increases, however, the space available for the adsorbed molecules decreases and, finally, we reach the condition where in order for any more molecules to fit into the adsorption space, a certain amount of crowding is necessary. At this point another factor enters into consideration, viz., the actual volume of the molecules of the adsorbed vapor. Since the  $\text{CCl}_4$  molecule has the largest volume of any of the members of the series, it would naturally show the greatest crowding effect. In this range of the concentration which reaches up to the saturation point, the order of adsorption is found to be actually the reverse of that given for the lower range.

In this discussion, we have neglected one factor, viz., the thermal energy of the molecules. Thus, we cannot say that for a given temperature the adsorption isotherms of the vapors show definitely the relations outlined above, or necessarily even for a given corresponding temperature. But for those temperatures where the internal energy of the molecules of each vapor is the same, the relations of Dewar and of Schmidt and Hinteler should hold for their respective concentration ranges. Such temperatures would be equal fractions of a characteristic adsorption temperature which is similar to the critical temperatures of vapors and to the characteristic temperatures for atomic heat capacities.

Characteristic relations for the four vapors may be expected to manifest themselves in the shape of the isotherms. If we assume that the crowding effect of the molecules is continuous, it should produce a flattening of the

isotherm, i.e., the adsorption should not increase as rapidly with pressure as it would in cases where the crowding effect is less. This should be definitely shown by the slope of the double-log isotherms, a value which corresponds to the factor  $1/n$  in the Freundlich equation:

$$x/m = \alpha \cdot p^{1/n} \quad (1)$$

These relations have been found to hold exactly. If we compare the plots of the double-log isotherms, (Figs. 1 to 4), and consider ranges not too close to saturation, we see that the slope of the curves for  $\text{CCl}_4$  is very small; it increases slightly for  $\text{CHCl}_3$ , and still more for  $\text{CH}_2\text{Cl}_2$ , and finally attains a

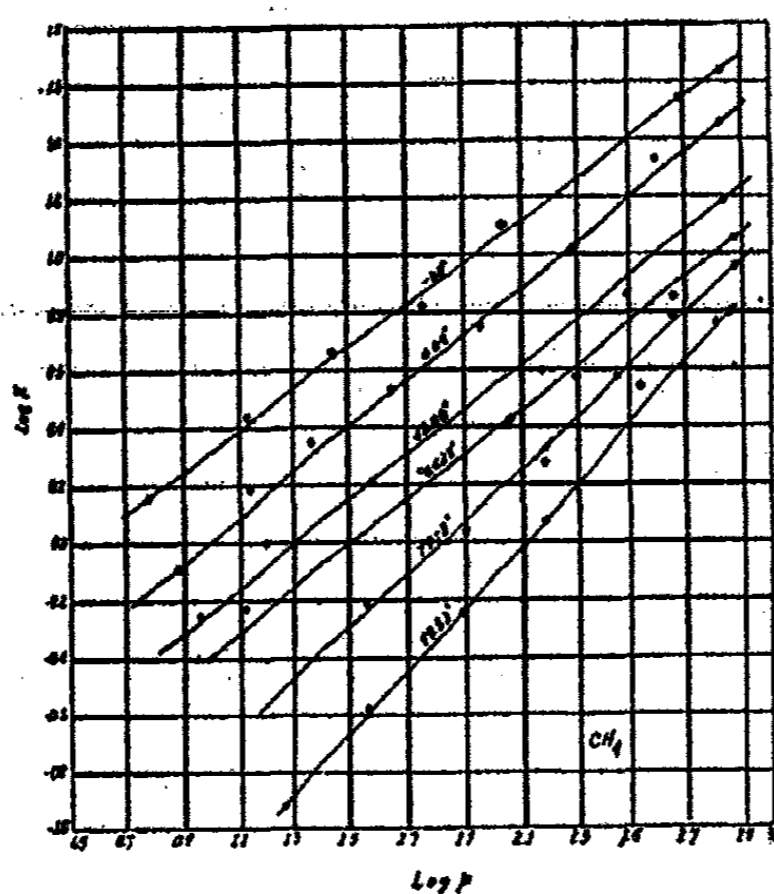

FIG. 1

maximum slope for  $\text{CH}_4$ . In all cases for any one vapor the value of the slope decreases with increasing concentration, the second derivative becoming smaller as the number of chlorine atoms in the molecule increases. The curves for  $\text{CCl}_4$  are therefore nearer straight lines than are those of any of the other vapors. In other words, the crowding effect begins earlier in the adsorption process for this vapor than for any of the others.

The intercepts of the double-log isotherms on the zero ordinate also offer some interesting relations. These values correspond to the logarithms of the factor  $\alpha$  in the Freundlich equation (1), where  $\alpha$  represents the amount of vapor adsorbed under unit pressure (1 mm.) at the given temperature. These values increase as the number of chlorine atoms in the molecule increases.

The influence of substituents on the slopes of the double-log isotherms is also to be seen in two other partial homologous series of vapors. Pearce and Knudson<sup>14</sup> have studied the adsorption of vapors of  $\text{H}_2\text{O}$ ,  $\text{CH}_3\text{OH}$ ,

<sup>14</sup> Pearce and Knudson: Proc. Iowa Acad. Sci., (1928).



$C_2H_5OH$ ,  $NH_3$  and  $CH_3NH_2$  by the same standard charcoal. The adsorption of the vapors of these two series is undoubtedly primarily due to the influence of the oxygen and nitrogen atoms, respectively. The oxygen atom in water and the alcohols should play the same role in adsorption as do the chlorine atoms in the series under investigation. The successive substitution of  $CH_2$  groups should increase slightly the actual volume of the individual molecules. We should expect, therefore, that the crowding effect of the water molecules be somewhat less than that experienced by the alcohol molecules. Consequently, the double-log isotherms for water vapor should have the greater slope, and this is actually the case. The isotherms for the two alcohols are

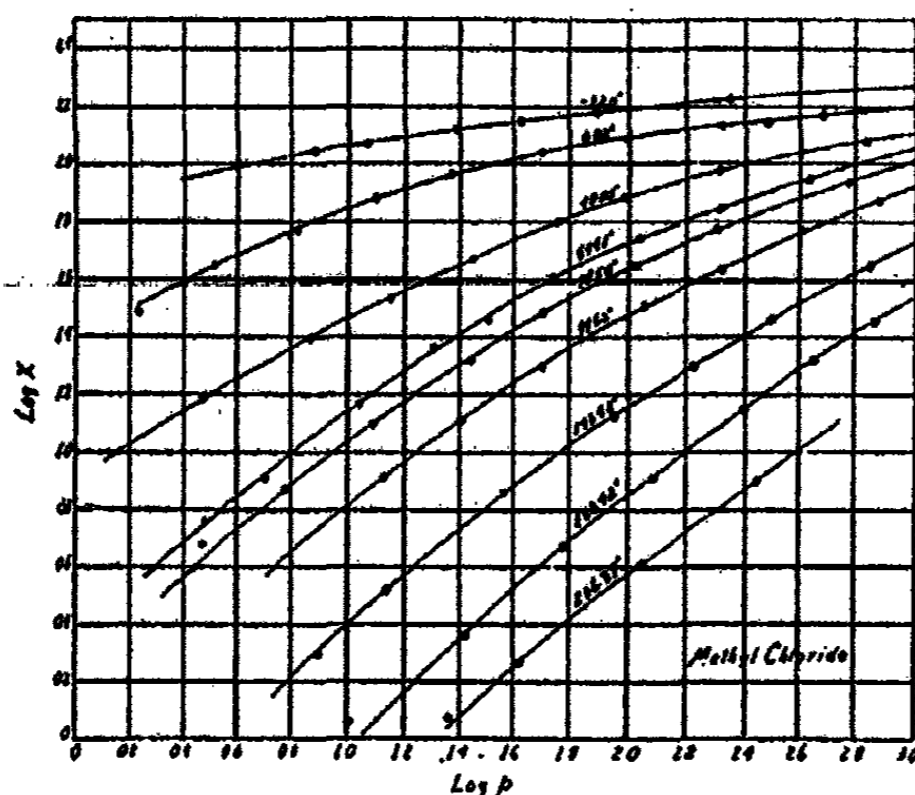

FIG. 2

less vertical and are nearly identical in shape. For ethyl alcohol, however, the slope at high concentrations is, as we should expect, much smaller than for methyl alcohol. In the case of  $NH_3$  and  $CH_3NH_2$ , the relative slopes and shapes of these isotherms are much the same as those for the alcohols. While the curves for each of the vapors of these two groups show the relations predicted, the relations may be somewhat modified, due to the fact that the hydroxy compounds are of the polar type and therefore tend to associate to a greater or less extent.

In an attempt to arrive at some quantitative relation for the results which have been discussed in this section we have plotted the molecular volumes of the substances in the liquid state against the logarithms of the concentrations at different equilibrium pressures for given corresponding temperatures of the respective vapors. The values of the logarithms were taken from the isosteres. The values for the molecular volumes were those at the boiling points of the liquids and, consequently, they do not represent the true molecular volumes at the chosen corresponding temperatures. For the corresponding temperature represented by  $0.584 T_c$  and for any given low pressure the points for each of the vapors studied in the present inves-

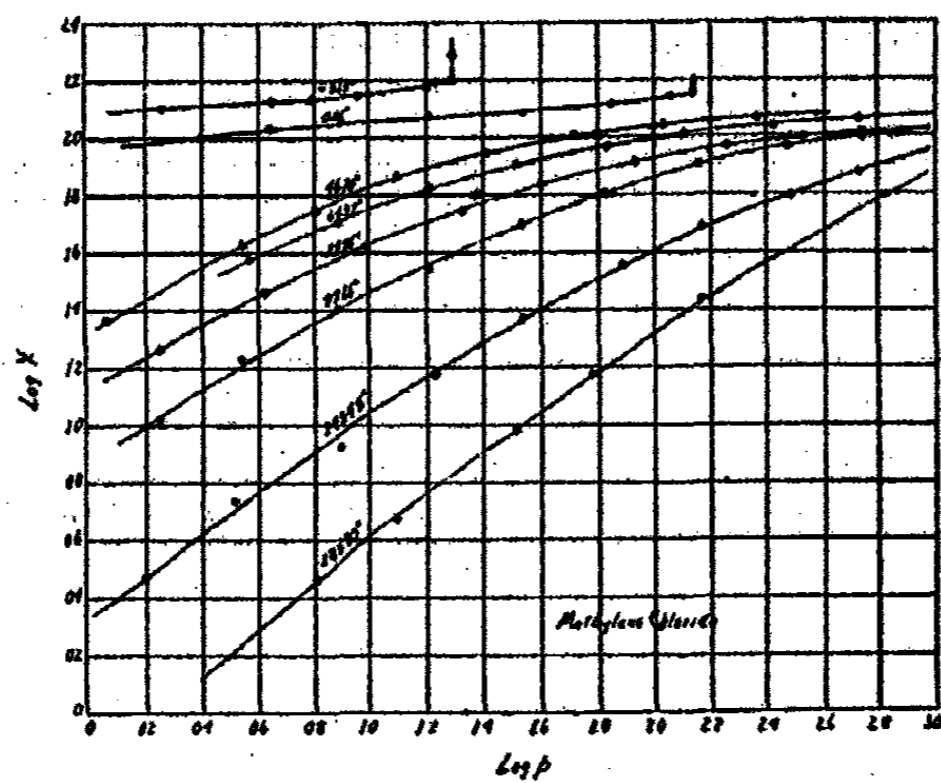

FIG. 3

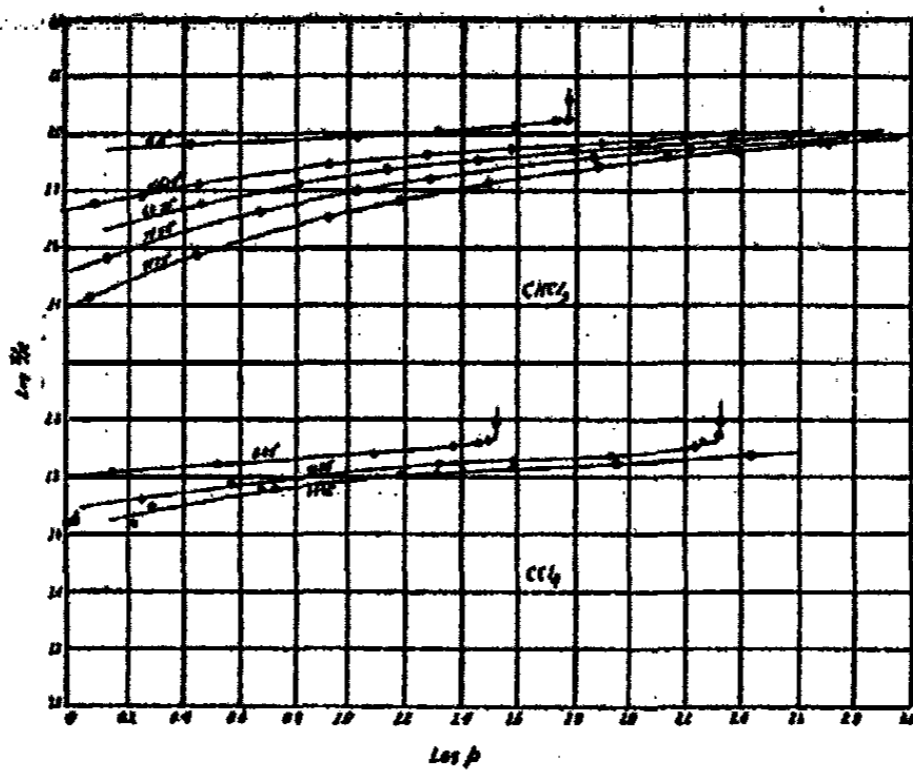

FIG. 4

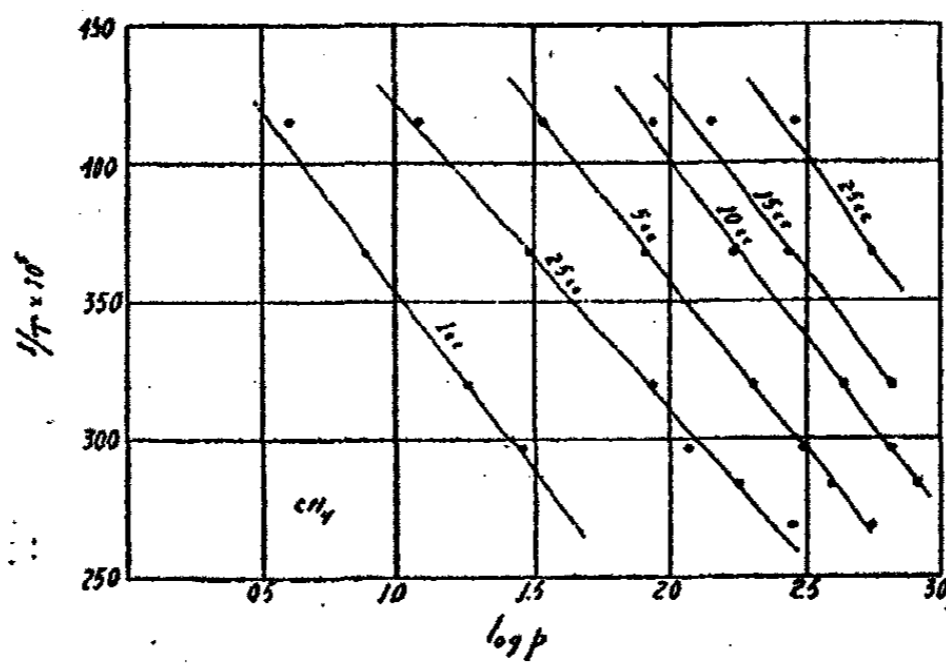

FIG. 5  
Isosteres CH<sub>4</sub>

tigation and in that of Pearce and Knudson<sup>12</sup> fall approximately on a smooth curve. This particular fraction of the critical temperature was chosen because it corresponds more nearly than any other to the temperature of the isotherms actually studied for all of the vapors. Further, the choice of a definite fraction of the critical temperature has the particular advantage in that it insures the probability that the various vapors in the adsorbed state will have the same thermal energy. It is obvious also that a comparison of

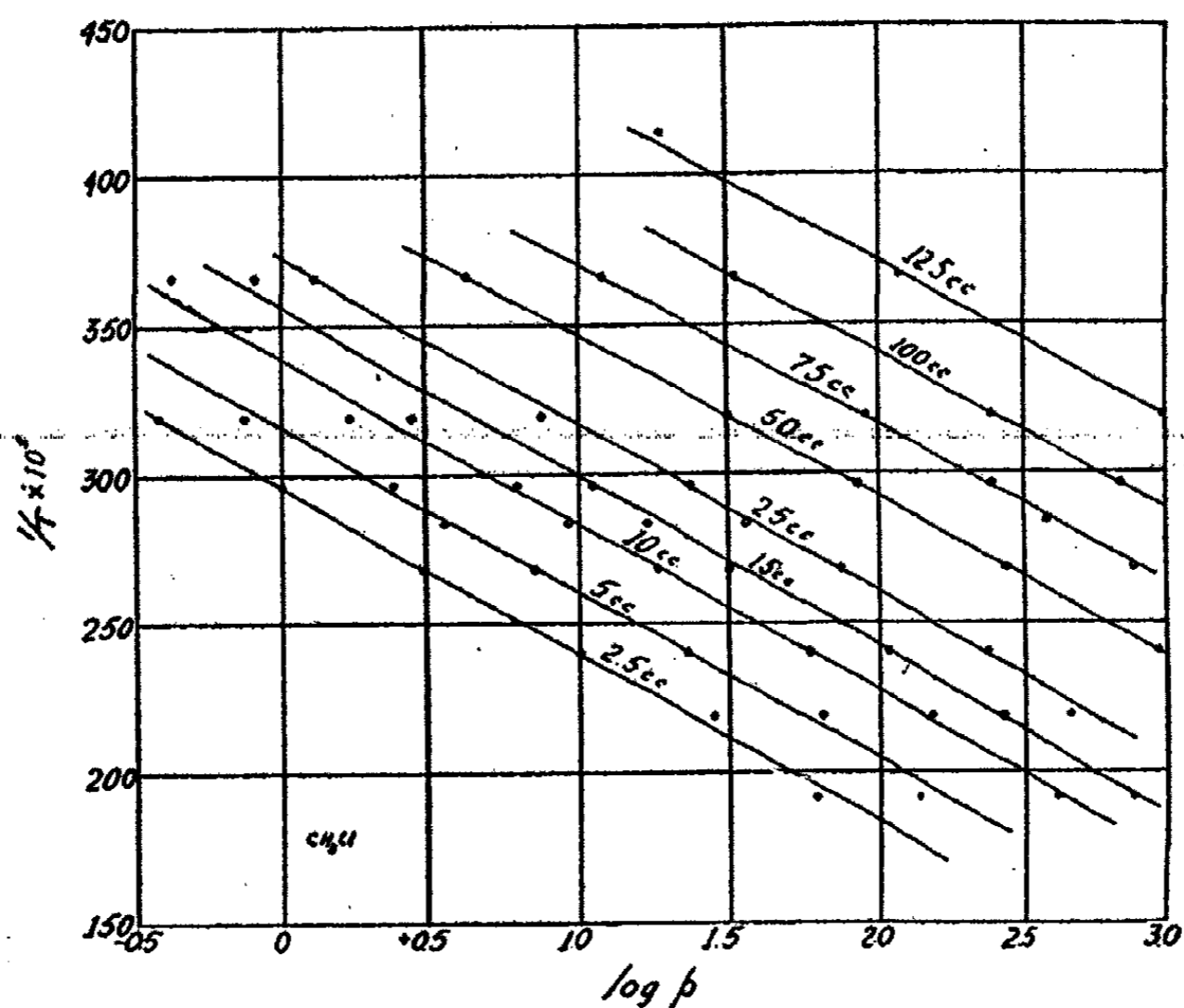

FIG. 6  
CH<sub>3</sub>Cl Isosteres

the effect of molecular volume on the adsorbability of the vapors should not be made except under the condition of equal thermal energies. The molecular volume-concentration curve thus plotted is hyperbolic in character, showing definitely that the volume of vapor in cc. adsorbed at a given pressure and corresponding temperature decreases with increasing molecular volume. At temperatures corresponding to 0.70 T<sub>c</sub> the deviations from the smooth curve are much greater. For high pressures the deviations shown by vapors whose liquids tend to associate are large and in all cases the experimental points lie on the side having the greater molecular volume.

It is obvious that the configuration of the adsorbed molecules will be of great influence in determining the number of molecules that can be adsorbed per unit surface. In a porous body such as charcoal the cavities are of all shapes and sizes; the influence of the size and shape of the molecules will be a dominating factor in the adsorption of vapors by charcoal. This will be discussed more fully in a later paper dealing with the adsorption of vapors of chlorine derivatives of higher aliphatic compounds.

## Isosteres

The isosteres representing the equilibrium pressure-temperature curves for adsorption systems of constant composition are given in Figs. 5 to 9. If the Clausius-Clapeyron equation is applicable to adsorption, the negative reciprocals of the slopes of these isosteres are proportional to the heats of

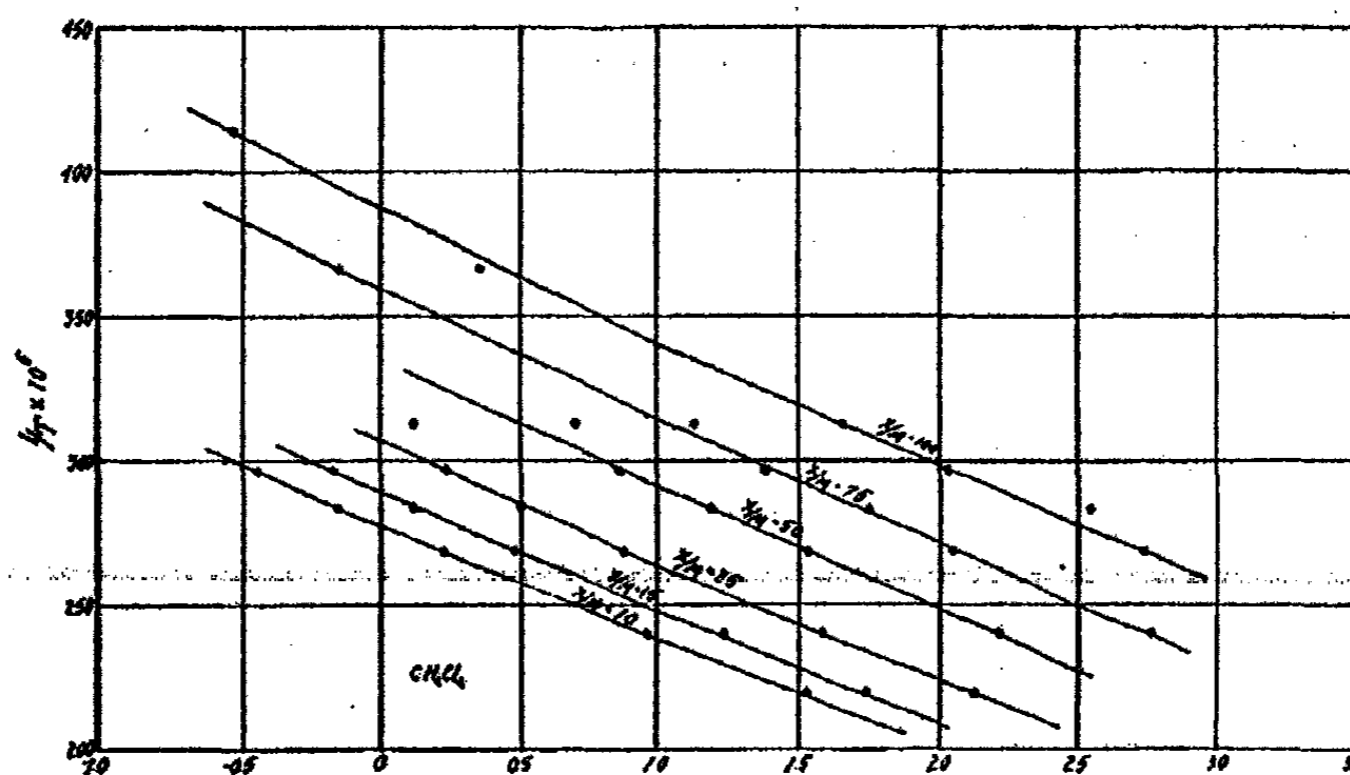

FIG. 7  
Methylene Chloride Isosteres

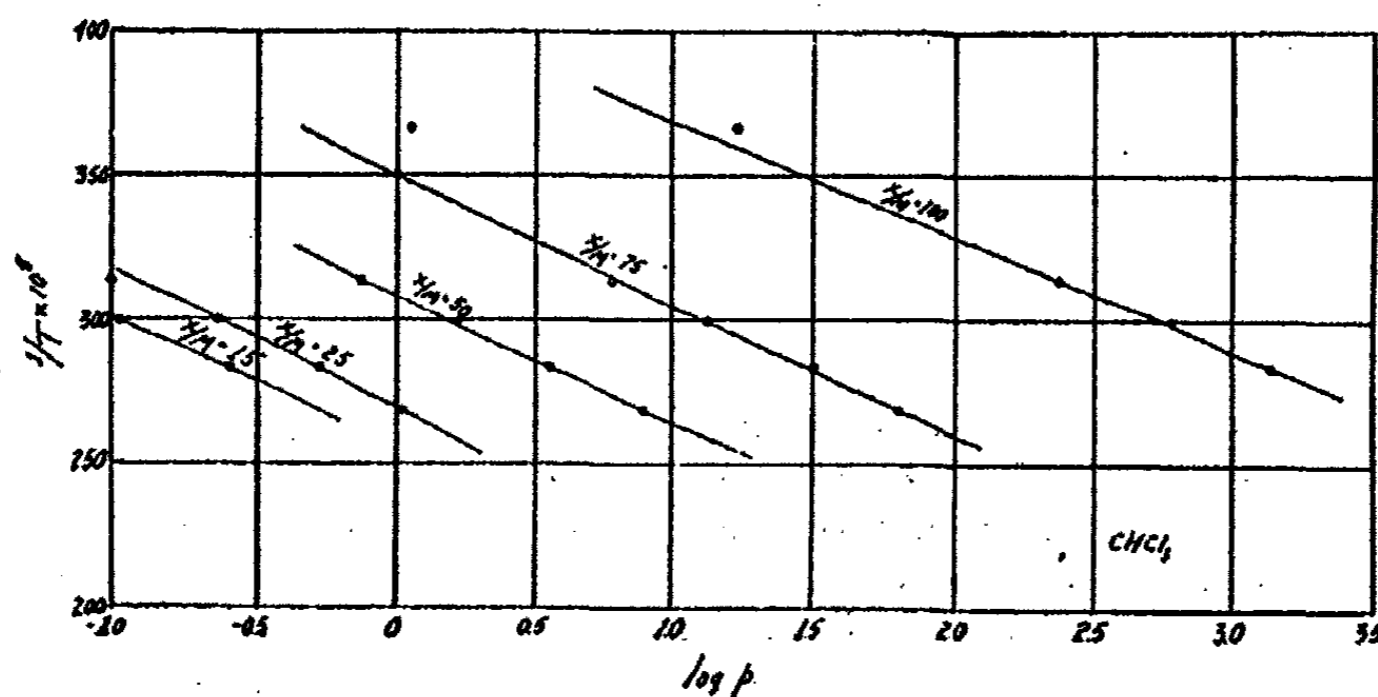

FIG. 8  
Isosteres  $\text{CHCl}_3$

adsorption. In his exhaustive paper on the interpretation of isotherms and isosteres Coolidge<sup>18</sup> has shown that the slopes of the isosteres should give values which agree with the measured heats of adsorption, in accordance with the relation

$$\Delta H = -R \frac{d \ln p}{d(1/T)} \quad (2)$$

<sup>18</sup> Coolidge: J. Am. Chem. Soc., 48, 1795 (1926).

It is significant that, except for carbon tetrachloride, the isosteres for any one of the vapors studied are practically linear and are parallel over their entire range. This would indicate that the heats of adsorption change very little, if at all, either with the temperature or composition. This is in perfect agreement with results obtained by Pearce and Reed<sup>10</sup> for the heats of adsorption of these vapors at 25° and 50°. The isosteres for carbon tetra-

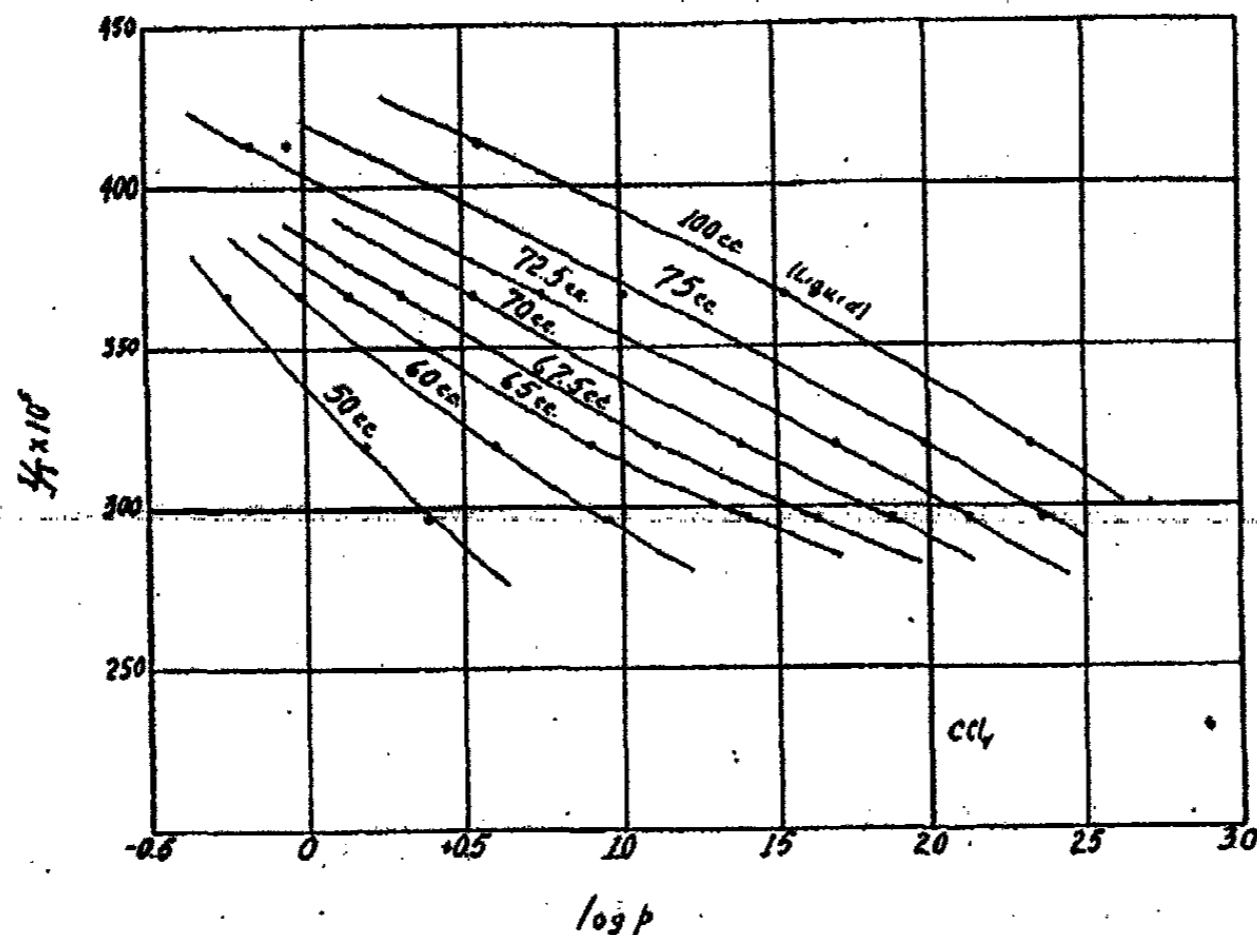

FIG. 9  
CCl<sub>4</sub> Isosteres

chloride, taken as a group are not straight lines and further, they tend to show a reversal of curvature near the isostere for  $x/m = 72.5$  cc. Lamb and Coolidge<sup>11</sup> have shown that the heats of adsorption differ from the heats of vaporization by constant amounts. This they believe is due to the compression caused by the adsorption forces. According to the Polanyi theory,<sup>7</sup> however, the surface of the adsorbed layer increases in distance from the surface of the adsorbent as more and more material is added, and finally it reaches the edge of the adsorption space. The adsorption potential, and thus the compressive forces, decrease very rapidly near the edge of the adsorption space. Hence the heat of compression must also decrease rapidly. In this range the heat of adsorption should decrease rapidly with the concentration until it finally equals the heat of vaporization. The peculiar behavior of the isosteres of carbon tetrachloride may be due to the circumstance that with this vapor we have worked with pressures near saturation. The isosteres of the remaining vapors are given only for concentrations far below saturation.

The great majority of our vapors are capable of existing as liquids at ordinary temperatures. The thermal effect produced when a vapor is ad-

<sup>10</sup> G. H. Reed: Master's Thesis, Iowa (1929).

sorbed is therefore most probably a complex consisting not only of the heat of adsorption itself, but including also the heat of condensation and the heat of compression. To be strictly comparable, therefore, the heats of adsorption of different vapors should be determined at temperatures at which normal condensation is excluded, and also at temperatures at which the thermal energies of the various vapor molecules are the same.

The heats of adsorption calculated from the isosteres on the basis of (2) are given in Table I.

TABLE I

Heats of Adsorption of the Vapors of Methane and its Chlorine Derivatives on Activated Charcoal

Vapor	$\Delta H$	Vapor	$\Delta H$
CH <sub>4</sub>	-3750 cal.	CHCl <sub>3</sub>	-10700
CH <sub>3</sub> Cl	-8300	CCl <sub>4</sub>	-8900
CH <sub>2</sub> Cl <sub>2</sub>	-10450		

Except for carbon tetrachloride, the heat of adsorption increases with increase in the number of substituted chlorine atoms, and this increase is proportionally greater with the first and second chlorine atoms introduced. While the heats of adsorption are all somewhat lower than the corresponding experimentally determined values, that of carbon tetrachloride is notably much too low. Pearce and McKinley<sup>17</sup> have found that at 25° and at low vapor concentrations the heat of adsorption of carbon tetrachloride is much higher than that of chloroform. At higher pressures, however, the heat of adsorption of carbon tetrachloride actually falls below that of chloroform. It is quite evident that the value given in Table I for carbon tetrachloride comes within the range of saturation. These relations confirm those shown in Fig. 10 in which the free energy of adsorption of carbon tetrachloride is also smaller than might be expected.

#### Isobars

The isobars of the vapors were plotted and the points were found to fall on uniformly smooth curves which spread out fan-like from a point at low temperatures. The curvature of the isobars for any one vapor decreases rapidly with increase in pressure, finally becomes zero and then changes sign at still higher pressures. The pressure for which the isobar has a zero curvature decreases as the number of chlorine atoms in the molecule is increased. This is also the order of increasing molecular weight. For methane and methyl chloride the linear isobar, if there is one, is above atmospheric pressure; for methylene chloride it seems to be at about 600 mm.; for chloroform about 50 mm., while for carbon tetrachloride it is below 1 mm. These facts appear to indicate that the effect of temperature on the amount of vapor adsorbed at a given pressure becomes less as the molecular weight, and also the number of substituted chlorine atoms, is increased. This is evidently due to an increase in the thermal capacities of the molecules such that the heavier

<sup>17</sup> Pearce and McKinley: *J. Phys. Chem.*, 32, 360 (1928).

molecules show less kinetic energy at a given temperature. Inasmuch as the kinetic energies of gas and vapor molecules are very nearly proportional to the absolute temperature alone, the shape of the isobars seem to show the state of the adsorbed material to be that of either a highly compressed gas or a liquid.

Jacquet<sup>8</sup> has derived an equation for the adsorption isobars on the basis of a continuous energy distribution throughout adsorption space. He shows that the amount of vapor adsorbed at a given temperature is given by the integral,

$$y = C \int_d^h (e^{u/kT} - 1) dh. \quad (3)$$

Here  $y$  is the number of molecules adsorbed,  $C$  is a constant of integration which depends on the units in which  $y$  is expressed,  $d$  is the molecular radius corresponding to the lower limit of the distance within which a molecule may approach the adsorbing surface,  $h$  is the distance of the outer edge of the adsorbed material from the adsorbent at the given pressure,  $u$  is the energy of adsorption of one molecule, and  $k$  is the Boltzmann constant.

In the adsorption space,  $u$  is, as we have seen, some function of the distance,  $h$ , from the adsorbent and Jacquet has suggested the usual formula,  $u = a/h^n$ , where  $a$  and  $n$  are constants, and  $h$  varies from the molecular radius,  $d$ , to infinity. For practical purposes we may consider the limit of the adsorption space as the maximum value of  $h$ . For the particular case where  $h = d$ ,  $u$  is the potential energy of the molecule in contact with the surface of the adsorbent. At that temperature  $\theta = a/d^n k$ . That is, when the kinetic energy of a molecule is the same as the potential energy of the molecule in contact with the surface of the adsorbent, we have a characteristic adsorption temperature. This is similar to the critical temperature of a gas,—the temperature at which the kinetic energy of the individual molecules in the gas space is equal to the potential energy of a molecule which is in the sphere of influence of another molecule. Jacquet points out that  $\theta$  is usually much higher than the ordinary temperatures used in adsorption experiments.

The integration of (3) is difficult and can only be carried out under certain limiting conditions. Two of these will be considered. For large values of  $\theta/T$ , i.e., for low temperatures, the integration yields

$$\ln y = u/kT + \text{const.} \quad (4)$$

This is the equation for the isobar; it is linear in  $\ln y$  and  $1/T$ . For high temperatures, i.e., when  $\theta/T$  is small, the integration gives

$$\ln y = \frac{u}{kT} - \ln \frac{u\theta}{T} + \ln \frac{u(\theta-1)}{kT} - \dots \quad (5)$$

At low temperatures, therefore, the isobars should be linear when  $\ln y$  is plotted against  $1/T$ , while at high temperatures they should bend away from the  $\ln y$  axis. These relations have been tested for the adsorption of methyl chloride vapor by charcoal and the curves obtained are similar to those predicted by the theory.

### The Polanyi Function

On the basis of a continuous distribution of the adsorption energy about a surface Polanyi<sup>7</sup> has shown that for temperatures below 0.8 T°c the adsorption potential of a vapor at any point in the adsorption space is given by

$$\epsilon_1 = RT \ln P/p_x, \quad (6)$$

while the corresponding volume enclosed by the equipotential surface is

$$\varphi_1 = x/\delta'. \quad (7)$$

In these equations P is the vapor pressure of the liquid in the free state,  $p_x$

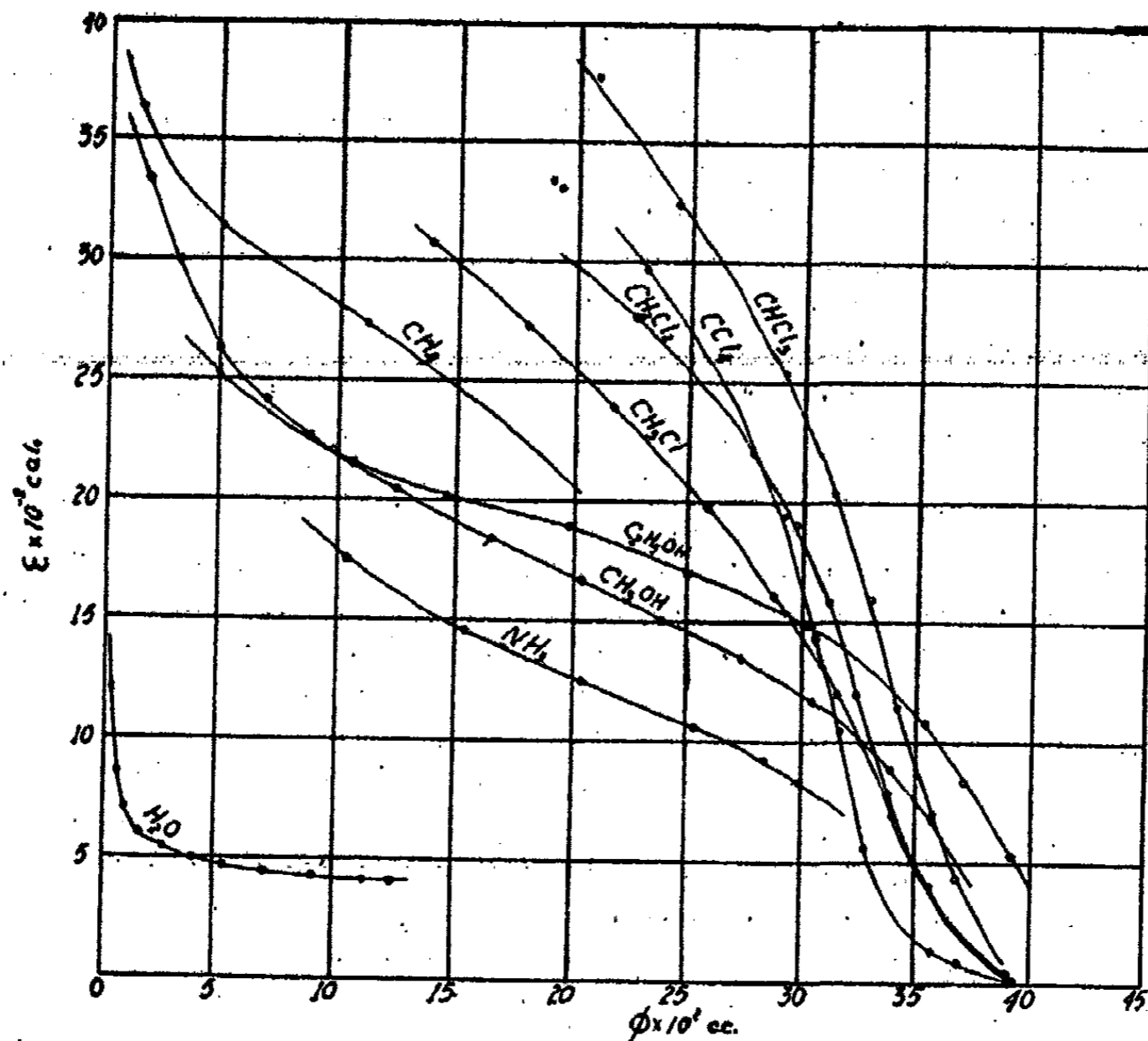

FIG. 10

the equilibrium pressure in the adsorbed state,  $x$  is the amount of vapor in the adsorption space and  $\delta'$  is its density. Furthermore, according to Polanyi, the potential distribution is constant for a given system, adsorbent-vapor, over all temperature ranges and, therefore, the function,  $\epsilon = f(\varphi)$ , should not vary. Since for any given temperature  $P$ ,  $\delta'$ ,  $R$  and  $T$  are constant, the  $(\epsilon-\varphi)$ -curves at low temperatures should have identically the same shape as the semi-log isotherms, and this we found to be actually the case.

Polanyi has also shown that once the  $(\epsilon-\varphi)$ -curves for a system have been determined any isotherm for that system may be calculated from a knowledge of the equation of state of the adsorbed material. Except for methyl chloride, the application of the Polanyi method to the vapors of methane and



its chlorine derivatives was not possible because of the absence of complete density and compressibility data covering the wide temperature ranges studied. For those cases where the necessary data is available the isotherms have been calculated and they are found to agree fairly well with those experimentally determined.

The method is of interest, however, in that the values of the adsorption potential,  $\epsilon$ , represent the free energy of adsorption, i.e., the amount of work performed in reversibly transferring one mole of vapor from the interior of the free liquid to a point in the adsorption space. Thus, the ( $\epsilon$ - $\varphi$ ) curves of the vapors show the change in free energy with the distance from the surface of the charcoal. These curves have been calculated by (6) and (7) for each of the vapors here studied as well as for those studied by Pearce and Knudson. They are shown in Fig. 10. The isotherms used for the calculations were those at 0° for all vapors except chloroform for which the isotherm at 46.25° was found to be most satisfactory. These isotherms lie well below 0.8 T°c for all of the vapors except methane. For methane it was necessary to use the Berenyi<sup>18</sup> modification of the Polanyi method. The values for the densities and for the van der Waal constants were taken from the Landolt-Börnstein Tabellen, Ed. 5. It was found that the ( $\epsilon$ - $\varphi$ )-curves calculated from two different isotherms for a single vapor did not exactly agree. This may be due to the errors involved in assuming the value of the liquid density, or possibly to a temperature coefficient which is not assumed to exist according to the Polanyi theory.

The curves, Fig. 10, show that the volume of the adsorption space is apparently independent of the nature of the adsorbed material and of the temperature. The value of  $\varphi$  when  $\epsilon = 0$ , i.e., when  $p_x = P$ , the saturation point, is so definite that for any adsorbent we may predict the amount of vapor which will be adsorbed at its saturation pressure from a knowledge of the saturation value of a single vapor. Coolidge<sup>18</sup> also has found that the volume of vapor adsorbed, measured as a liquid of normal density, is approximately the same irrespective of the nature of the vapor. He finds that the volume of the adsorption space of 1 g. of his charcoal at 0° varies from 0.424 cc. for water vapor to 0.494 cc. for ether. This would suggest a linear relation between the volume and the compressibility in as much as the values would be more nearly identical, if a correction were made for compressibility. For our standard charcoal, which is only about 50 percent activated, the volume of the adsorption space of one gram of charcoal is somewhat smaller, about 0.393 cc. This value seems to be about the same for all vapors and for temperatures which lie well below the critical temperatures.

As the distance to the surface of the adsorbent decreases the adsorption potential increases rapidly near the edge of the adsorption space. As shown by the curves this increase appears to be greater the greater the number of chlorine atoms in the molecule. The apparent deviation of carbon tetrachloride from the rule was discussed earlier in connection with other of its

<sup>18</sup> Berenyi: Z. physik. Chem., 94, 928 (1920); Z. angew. Chem., 35, 237 (1922).

properties. As we continue to approach the surface of the charcoal the rate of increase in potential falls off until very near the surface when the potential again rises very rapidly. The curves probably do not extend to infinite values of  $\epsilon$ , however, for at finite distances from the adsorbent the repulsive forces should balance those of attraction. It will be observed that for the vapors which tend to associate in the liquid state the potential does not increase so rapidly until very near the surface of the adsorbent. This is probably due to the fact that less work is required to bring these polar molecules to a point in the adsorption space than is required for the non-polar molecules between which the attraction is not so great. After a single layer of molecules has been formed the building up of other layers is much easier. This effect is very large for water which admittedly shows a high degree of association.

Berenyi<sup>18</sup> has offered a method for determining the distribution of the adsorbed substance in the adsorption space for temperature ranges above the critical temperatures of the vapors. By studying the variation of the density with the distance from the adsorbent for several gases he found that by considering the adsorption space somewhat smaller than it actually is no great error is introduced, if we take for the cross-sectional density the maximum value demanded by van der Waals' equation for infinite pressure, viz.,

$$\delta = \frac{M}{22412 \cdot b}$$

Here  $\delta$  is the density in grams per cc.,  $M$  is the molecular weight and  $b$  is van der Waals' constant for 1 cc. of gas. Thus, if  $x$  is the number of grams in the adsorption space, the volume enclosed by the equipotential surface is

$$\varphi_1 = \frac{22412 \cdot x \cdot b}{M} \quad (8)$$

The potential corresponding to this surface is given by the thermodynamically derived relation,

$$\epsilon_1 = RT \ln \frac{RT}{p_x \left( \frac{1}{\delta_1} - b \right)} - \frac{2a\delta_1}{RT} + \frac{1}{1 - b\delta_1} - 1, \quad (9)$$

where  $\delta_1$  is the density at the equipotential surface 1;  $a$  and  $b$  are the van der Waal constants. It is to be noted that at high temperatures  $a\delta_1/RT$  and  $b\delta_1$  become negligible so that the calculation of  $\delta_1$  from  $\epsilon_1$  is greatly simplified.

The  $(\delta-\varphi)$  curves have been calculated by means of equations (8) and (9); they are shown in Fig. 11. These show the distribution of the vapor molecules at high temperatures where all of the adsorbed material is in the gaseous state. They show also the change in density in mols per liter at various distances from the surface of the adsorbent at atmospheric pressure and at a temperature equal to 1.1 T°C. If the curves are extrapolated to the zero ordinate, the area under each curve represents the amount of vapor in mols adsorbed by 1 g. of charcoal at 1.1 T°C and 760 mm. The position of the chloroform curve is somewhat doubtful because the values of the density and of the van der Waal constants are known only approximately. For the other

vapors containing chlorine atoms, the increase in the number of mols per cc., as the adsorbent is approached, is much greater for the smaller than for the larger molecules. The position of the ( $\delta$ - $\phi$ ) curves for vapors whose liquids tend to associate is interesting in that for all vapors the number of molecules per<sup>3</sup>cc. is smaller than for the normal liquids.

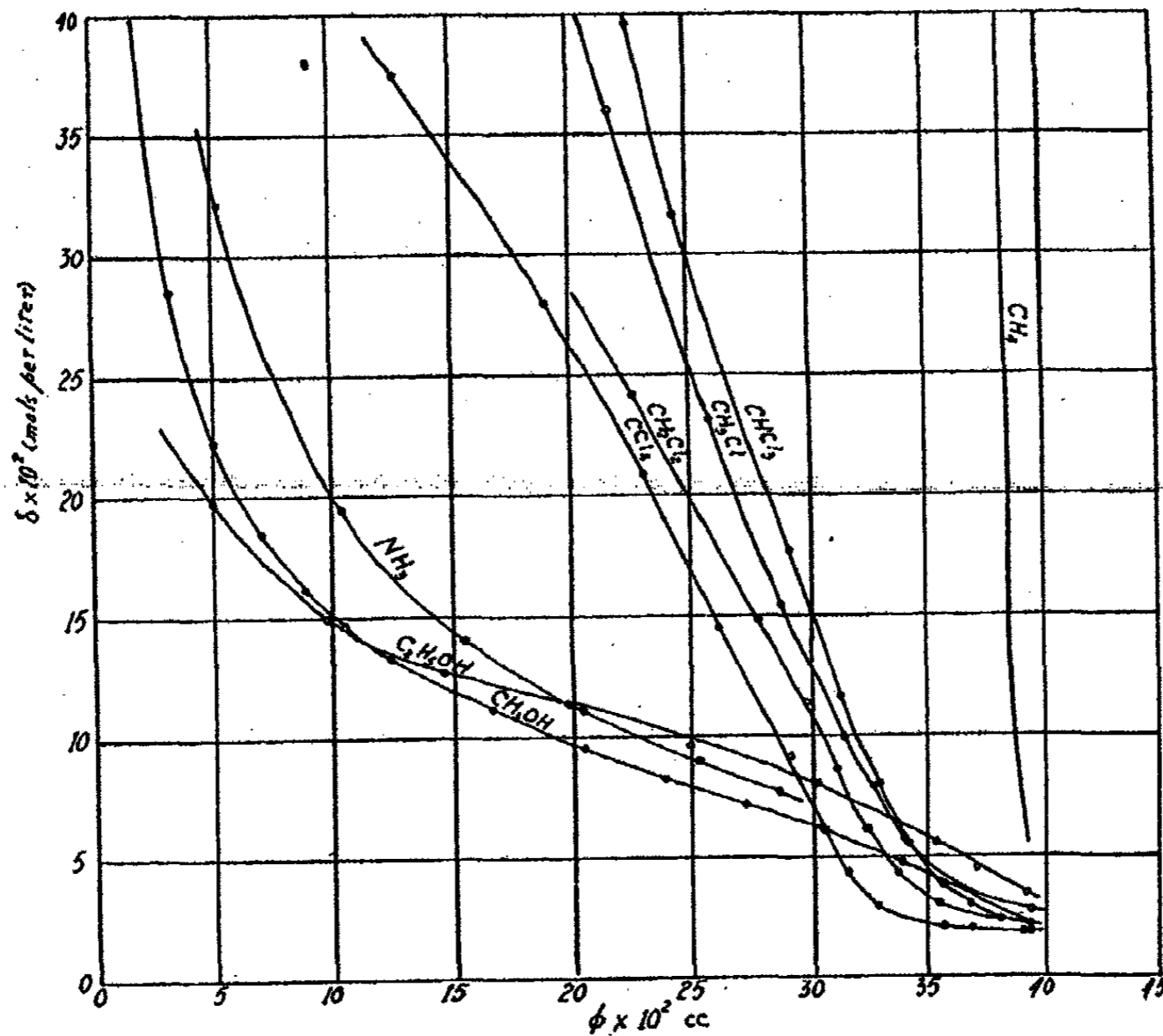

FIG. 11

Summary

A study has been made of the adsorption of methane and its chlorine derivatives by activated charcoal at temperatures ranging from the lowest usable up to that of decomposition. The influence of successive substitution of chlorine atoms on various adsorption magnitudes has been noted and discussed. The potential distribution and the density distribution within the adsorption space has been calculated. In general, the results obtained are in harmony with the theory put forth by Polanyi and others that the adsorbed layer is more than one molecule in thickness.

Physical Chemistry Laboratory,  
The State University of Iowa.

48-80.

## CHEMICAL ACTION IN THE GLOW DISCHARGE IV. THE SYNTHESIS OF OZONE\*

BY A. KEITH BREWER AND J. W. WESTHAVER

The innumerable investigations on the synthesis of ozone in various types of electrical discharges, by  $\alpha$  ray bombardment, and by ultra-violet radiation indicate that ozone is readily formed around positive oxygen ions, and possibly around oxygen atoms and excited oxygen molecules. A direct comparison of the relative reactivities of these various forms is completely lacking. Considerable evidence has been accumulated which indicates that inert gases such as nitrogen are positive catalysts in ozone formation. The function of the catalyst or of any of the mechanisms involved, however, is a matter of conjecture.

The difficulty in the study of ozone formation is an inherent one, arising out of its extremely unstable nature. It is almost impossible to obtain the direct formation under conditions where decomposition is absent or negligible. For this reason most investigators have confined their study to conditions at or near equilibrium, and so can say little regarding the mechanism.

Recently Lind<sup>1</sup> in synthesizing ozone by  $\alpha$  ray bombardment, has obtained a ratio of ozone molecules to oxygen ions of  $M/N = 1.5$ . Busse and Daniels<sup>2</sup>, using cathode rays, report a yield of one molecule of ozone per 15 electron volts; this is equivalent to a minimum ratio of  $M/N = 1$ . Hunt<sup>3</sup>, using the glow discharge, obtained as a lower limit  $M/N = 0.03$ . These ratios are all fairly high and show that decomposition has been reduced to a low value.

In the earlier papers of this series<sup>4</sup> a technique has been developed for the synthesis of ammonia and of nitrogen dioxide in the glow discharge wherein only the forward reaction is in evidence, the back reaction having been eliminated by freezing out the products with liquid air as fast as formed. This technique has the further advantage of enabling a distinction to be made between the relative reactivity of positive ions, neutral atoms, and excited molecules. It was thought advisable, therefore, to apply the method to the synthesis of ozone. A comparison of the relative efficiencies of  $O^+$  ions and atoms in forming ozone is very pertinent at this time in view of the interest centered on the presence of ozone in the upper atmosphere.

### Experimental

The apparatus and method of procedure were identical to those described previously, except that a double McLeod gauge was used which enabled

\* Fertilizer and Fixed Nitrogen Investigations, Bureau of Chemistry and Soils, U. S. Department of Agriculture.

<sup>1</sup> J. Am. Chem. Soc., 51, 2751 (1929).

<sup>2</sup> J. Am. Chem. Soc., 50, 3271 (1928).

<sup>3</sup> J. Am. Chem. Soc., 51, 30 (1929).

<sup>4</sup> J. Phys. Chem., 33, 883 (1929); 34, 159, 0000 (1930).

pressures to be read accurately up to 2 cm. of mercury. It was necessary to modify the discharge tube so that the positive column could be studied; the tube used is illustrated in Fig. 1.

The procedure was as follows: After the system has been well evacuated the desired amounts of gases were admitted and trapped by a mercury cut off. Liquid air was raised on the tube and, with the discharge maintained at constant current, readings of the McLeod gauge and electrostatic voltmeter were made at intervals of  $1/2$  minute until the pressure showed no further decrease. The time-pressure and time-voltage curves were plotted immediately after each run, and, except for occasional errors in readings, the points were found to lie accurately on a smooth curve.

#### Synthesis in the Negative Glow

In all the experiments performed to date it has been impossible to freeze out ozone in the negative glow of a discharge. This is true for discharge tubes in which the positive column is absent, i.e., with electrodes less than 3 cm. apart, as well as for those tubes in which the positive column is uncooled, only the negative glow being immersed in liquid air. The inability to synthesize ozone in the negative glow is probably due to the fact that in this region ozone is decomposed as fast as formed. Indeed this was shown to be a possible explanation by first freezing out ozone on the anode and surrounding walls and then reversing the polarity. Not only did the pressure rise showing an ozone decomposition, but a visual observation showed all ozone to be removed from the walls to a distance of about 3 centimeters from the cathode.

Gas phase decomposition of appreciable amounts of ozone was found to occur almost instantaneously upon the starting of the discharge.

#### Synthesis in the Positive Column

##### *The Discharge Tube.*

The synthesis of ozone takes place readily in the positive column of a discharge tube immersed in liquid air. The ozone is deposited on the walls of the tube as a blue liquid film. Since the vapor pressure of ozone at liquid air temperature is in the neighborhood of 0.2 mm., synthesis can not be carried below this pressure.

Ozone is rapidly decomposed in the discharge at room temperature. By allowing the liquid ozone to evaporate into the discharge, therefore, the same oxygen can be used for an extended series of runs. Apparently the con-

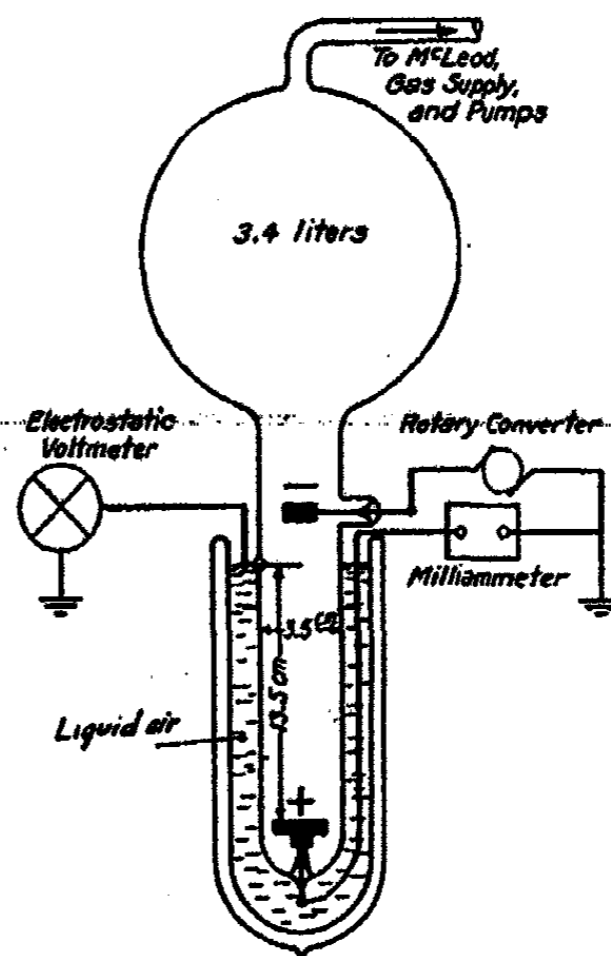

FIG. 1  
Discharge Tube for Ozone Formation

centration of ozone in the uncooled discharge is very low since no observable contamination of the mercury in the McLeod gauge or mercury cut-off could be detected when this procedure was followed.

A large variety of discharge tubes was tried in studying the factors influencing the mechanism. The results in all cases were concordant, indicating that the rate of synthesis was proportional to the length of column immersed and increased somewhat with the bore of the tube. The results presented in this paper were obtained with the tube illustrated in Fig. 1.

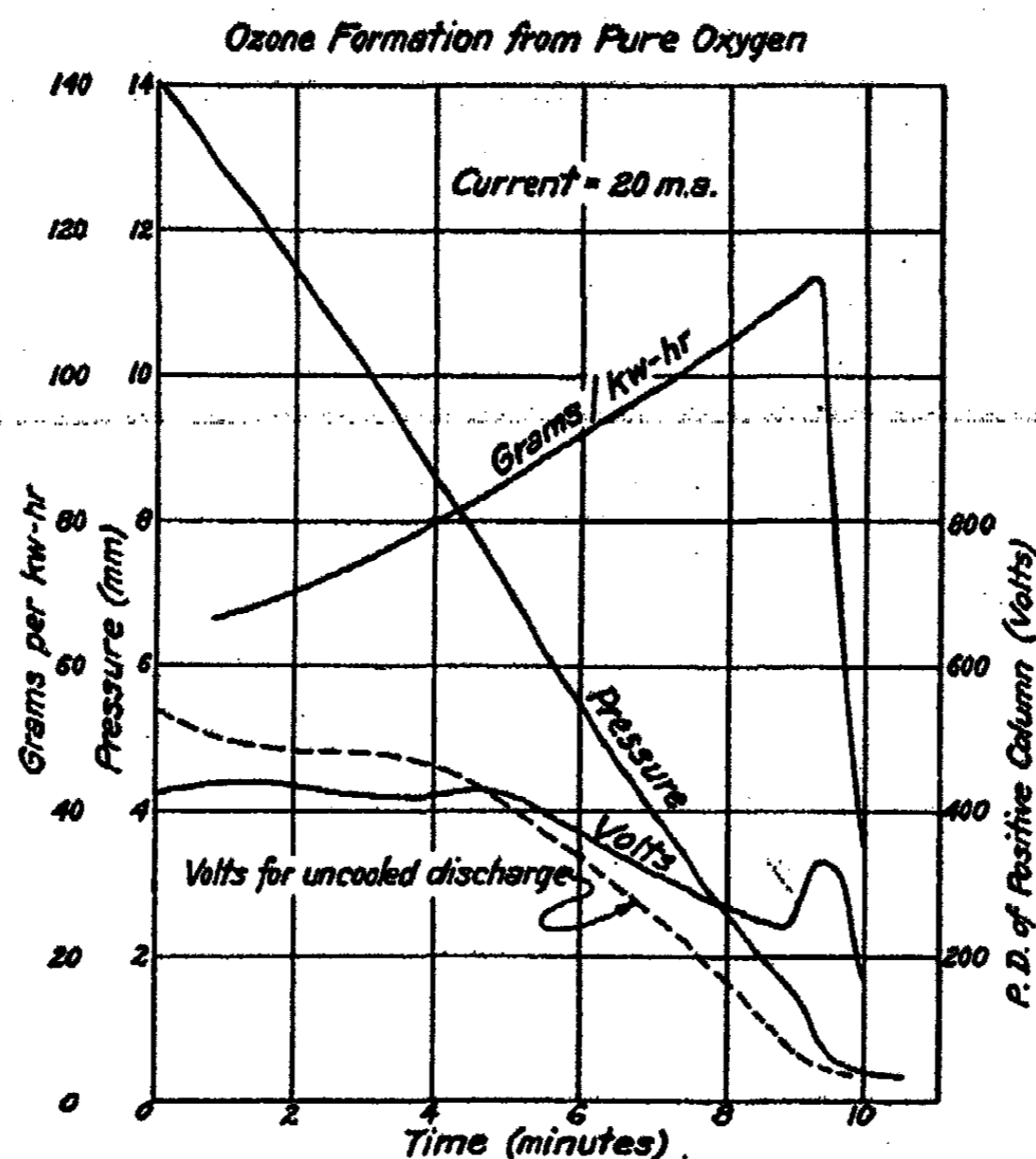

FIG. 2

#### *The Effect of Pressure.*

In Fig. 2 are given the data obtained from a typical run in oxygen. The oxygen was purified by a series of fractional distillations of liquefied tank oxygen and also by calcining potassium permanganate; the results were identical in either case. The voltages recorded are for the fall of potential across the immersed positive column.

It will be noted that for constant current the linear time-pressure relationship previously reported in connection with the synthesis of ammonia and nitrogen dioxide does not hold rigorously for the synthesis of ozone. These slight variations in rate with pressure were the cause of a large amount of experimentation. The decrease in rate above 10 mm. results largely, if not entirely, from a temperature effect due to the slow warming up of the gas and

the electrodes. The slowing down in the rate commencing at 2.5 mm. and culminating in a sharp break at 1.5 mm. has been traced to a slight decomposition of the ozone film covering the walls.

The break in the curve at 1.5 mm. resulting in a sudden increase in rate is concomitant with a rise in potential drop across the column. Like the slowing down between 2.5 and 1.5 mm., it is also connected with the ozone film on the walls, since both are entirely absent when there is no ozone film covering the walls. This was shown by starting the synthesis at an initial

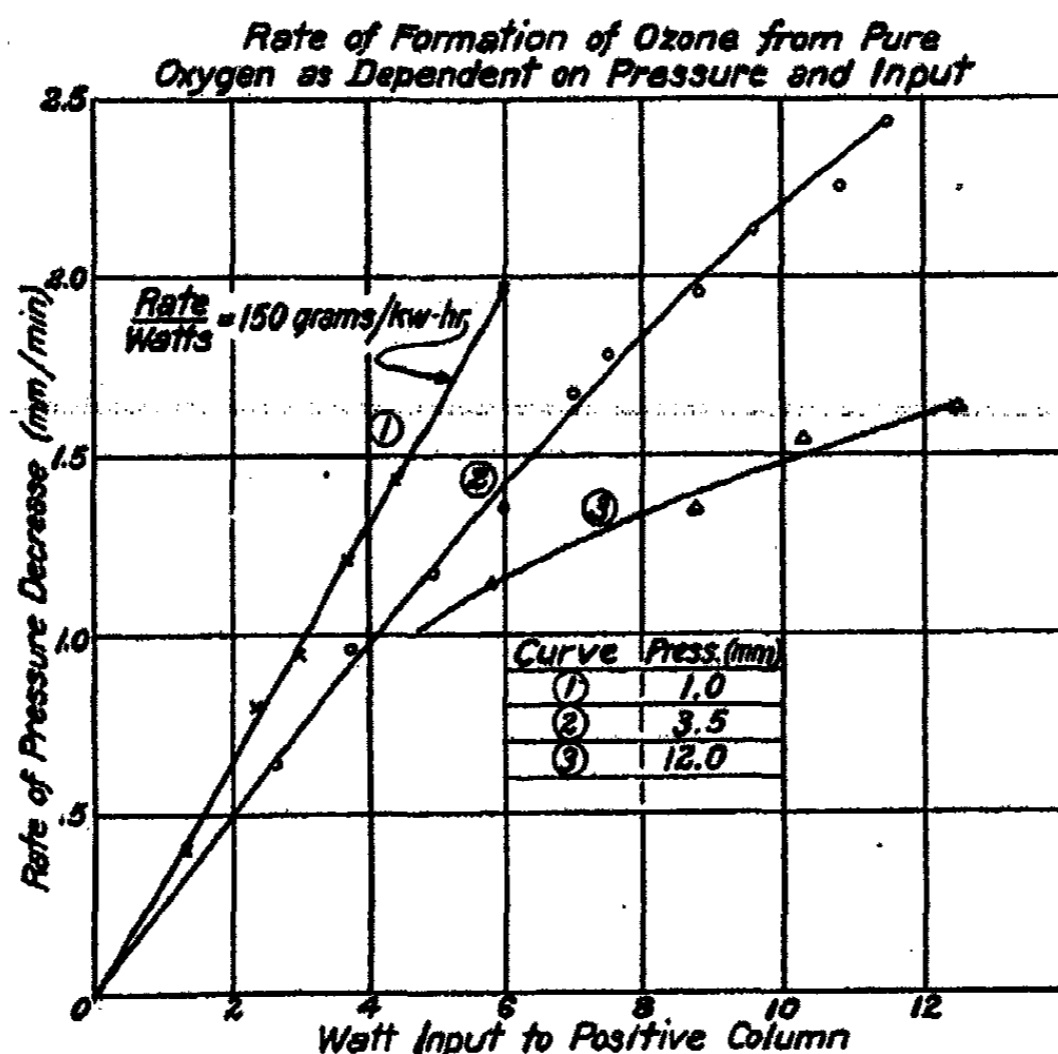

FIG. 3

pressure of 2 mm. It was at first thought that the break might be related to the Kirkby effect<sup>5</sup> but the voltage characteristics of this pressure range at room temperature contained no such break. It was later found that the potential drop across the column could be increased by several fold if a very small amount of ozone was allowed to evaporate into the discharge. For a constant current the increased potential drop occasioned by the sudden evaporation of a trace of ozone into the discharge causes an increase in the power input to the positive column, a greater part of which is expended in producing additional ionization. The action of evaporated ozone, therefore, is to produce a regenerative or auto-catalytic effect on the rate of synthesis.

*Rate of Synthesis and Power Input.*

The relationship between rate and power input is illustrated in Fig. 3. The points on these lines were computed from a series of curves similar to

<sup>5</sup> Phil. Mag., 2, 913 (1926).

Fig. 2, but for different currents. The difficulty in following the reaction for the higher power inputs accounts for the observed scattering of the points about their respective lines. The results are distinctly different from those reported for ammonia and nitrogen dioxide in that the rate is more nearly proportional to the power input than to the current.

Curve 1 represents the reaction rates measured at a pressure of 1 mm. with currents ranging from 2 to 15 m.a. The initial oxygen pressure was 2 mm.

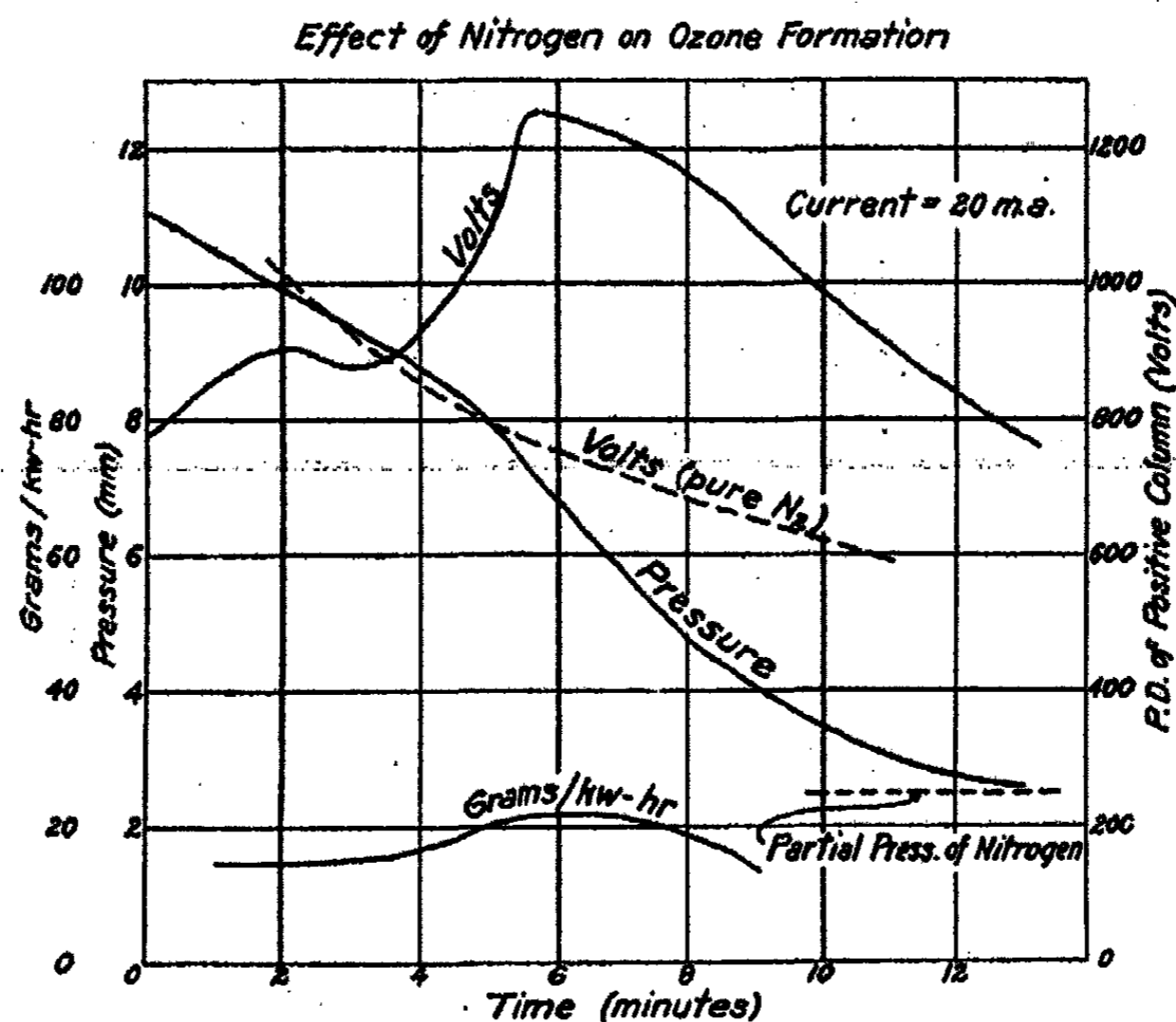

FIG. 4

Higher currents could not be used in these particular experiments without danger of melting the electrodes. It will be seen from curve 1 that the reaction rate at low pressures and currents is proportional to the power input in the positive column. The yield of 150 gms. per kw.hr. or one molecule per 11.9 electron volts was the maximum obtained in these experiments. This is equivalent to a minimum M/N ratio of 1.19 ozone molecules per  $O^+_2$  ion.

Curve 2 is for reaction rates measured at 3.5 mm., and currents from 5 to 50 m.a.; it will be noted that the yield falls off slightly for the higher currents.

Curve 3 gives the yields at 12 mm. pressure with currents from 10 to 40 m.a. At this pressure the discharge could not be maintained below 10 m.a., and it was also necessary to start the discharge with an induction coil. The yield is much less than for the lower pressures.

It is evident from these data that, while the yield decreases materially for the higher pressures and current densities, it tends to approach a constant value at all pressures provided the current density is sufficiently small. Since



Effect of Argon on Ozone Formation

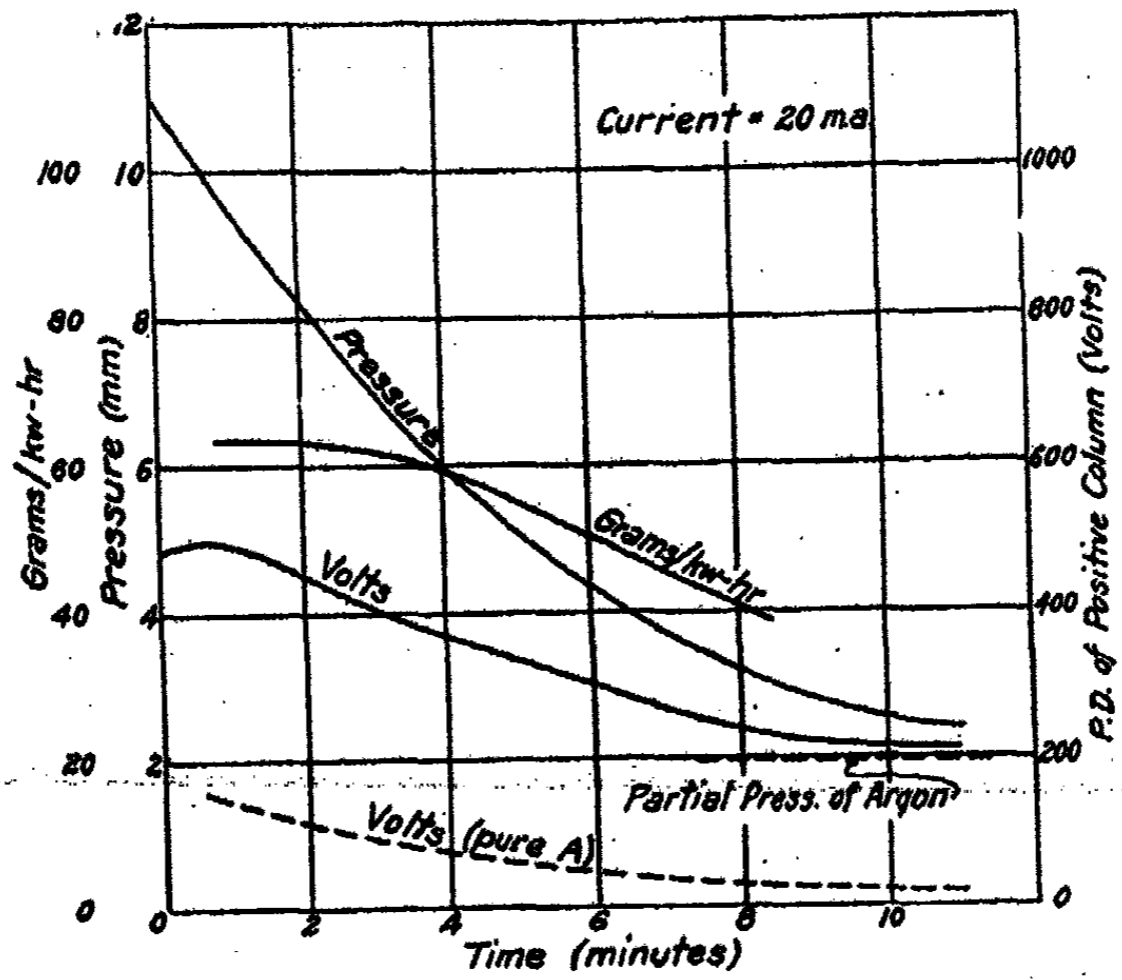

FIG. 5

Effect of Helium on Ozone Formation

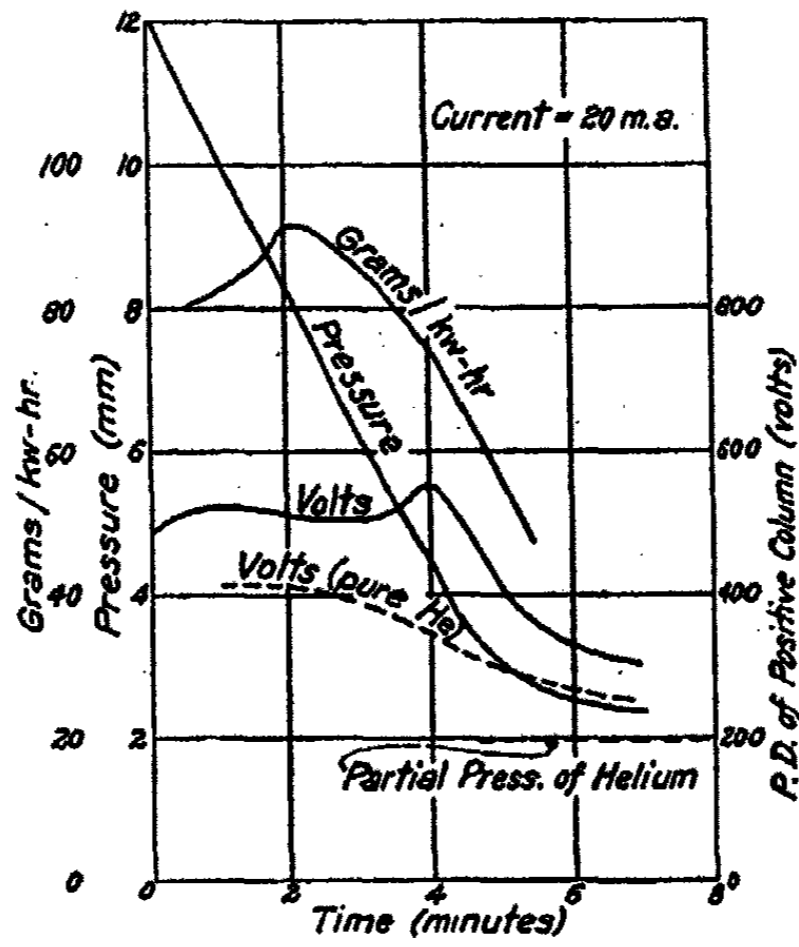

FIG. 6

ozone is decomposed with extreme rapidity in the discharge the decrease in yield at high current densities is evidently due to gas phase decomposition. Such a decomposition would be particularly evident at high pressures where the rate of diffusion of the newly formed ozone molecules to the walls is slow.

### Mixtures of Oxygen with Other Gases

#### *Nitrogen.*

A typical run to determine the effect of nitrogen on the rate of synthesis is shown in Fig. 4. The partial pressure of nitrogen for this run was 2.5 mm.

Of particular interest is the sudden break in the time-pressure curve occurring at 8 mm. A break similar to this was always observed, the pressure at which it took place increasing with the partial pressure of nitrogen. Coincident with this break was a sharp rise in voltage, although neither pure nitrogen nor pure oxygen in the absence of an ozone layer showed any such voltage rise, nor did such a rise in potential gradient occur for any mixture of nitrogen and oxygen in the uncooled discharge. It seems probable that this break is an accentuation of the break in nitrogen-free oxygen which occurs at about 1.5 mm., and is due to the same basic cause, namely, the evaporation of ozone from the film covering the walls.

#### *Argon.*

Fig. 5 shows the effect of a partial pressure of 2 mm. of argon on the rate of synthesis.

No break in the time-pressure curves was noted at any pressure or composition. The rate showed only a gradual decrease with increasing percentage of argon.

#### *Helium.*

The characteristic effect of helium on the rate of synthesis is shown in Fig. 6.

While helium shows no appreciable break in the time-pressure curve, this effect apparently is not completely absent as is evidenced by the break in the voltage curve occurring at about 4.5 mm. pressure in the particular run illustrated. It is possible that this break is due to traces of nitrogen in the helium, but this is improbable since the helium was allowed to stand for days over active charcoal immersed in liquid air.

#### *The Effect of Percent added Gas.*

The data obtained in a complete series of runs similar to those illustrated in Figs. 4, 5, and 6, in which the composition of the mixture was changed by small intervals from pure oxygen to pure added gas, are summed up in Fig. 7.

The nitrogen curve is especially interesting in that nitrogen is often referred to as a positive catalyst in ozone formation. The results clearly show that under the condition of these experiments no such property can be attributed to nitrogen. The results are peculiar in that the potential gradient through the positive column rises to a maximum for a mixture containing about 55 per cent nitrogen. This result must be due to the presence of the

ozone layer, for in the uncooled discharge no such maximum in the voltage curve could be observed, the values in all cases lying between that of pure nitrogen and pure oxygen.

The voltage curve for added argon in the cooled discharge is similar to that obtained when uncooled, since all points fall between the values for pure oxygen and pure argon. The effect of argon on the yield is not distinctive, the yield decreasing nearly proportionally to the percent of argon present.

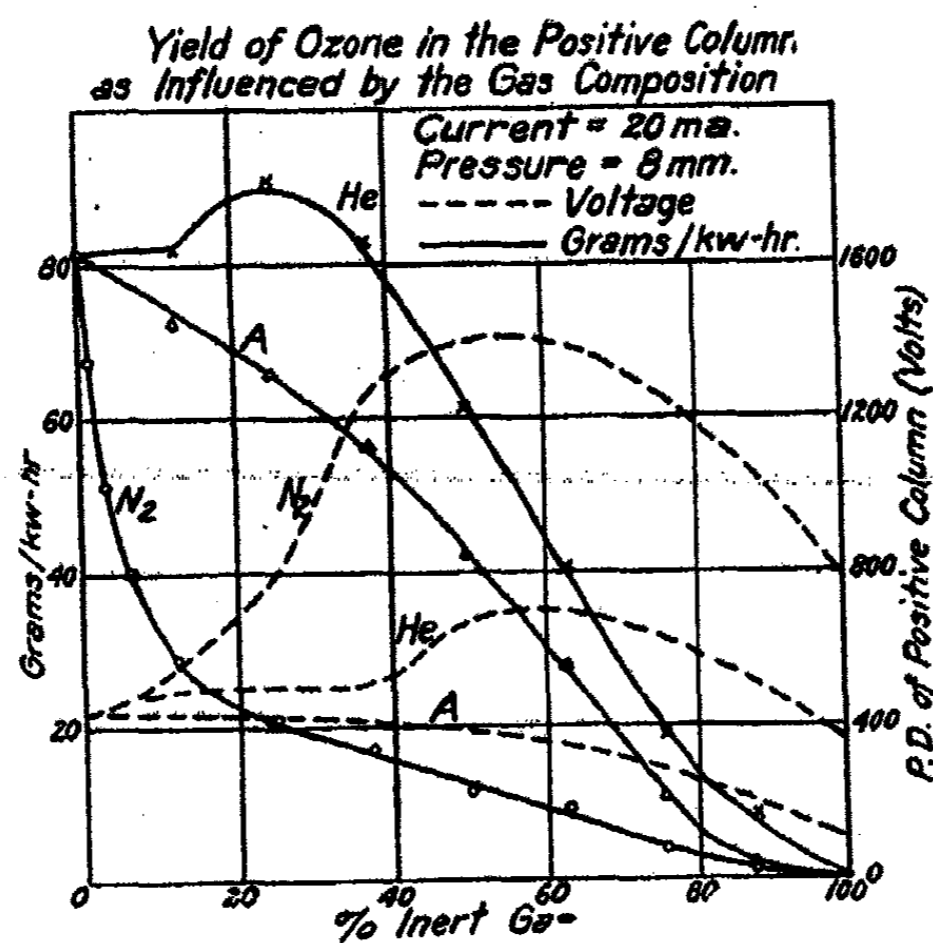

FIG. 7

Helium in its voltage characteristics lies intermediate between nitrogen and argon. The yield curve is peculiar in that helium up to 40% has no retarding effect on the amount of ozone synthesized; in small amounts it even enhances the yield. In referring to the time-pressure curve in Fig. 2, it will be seen that the effect of helium on the reaction rate is small although the percent helium increases with decreasing pressure. The enhancement in the yield found for small amounts of added helium at higher pressures was found to be absent for similar compositions at low pressures. The effect is probably an indirect one in that helium will permit a more ready diffusion of ozone to the walls and thus decrease the gas phase decomposition which is present at high pressures. Since the ionization potential of helium is about 10 volts higher than that of oxygen, the rate of formation of  $O_2^+$  ions is not materially effected by the presence of small amounts of helium.

#### Computation of Ozone Yield

The total measured volume of the static system was 4.30 liters; the average temperature was estimated to be 20°C. A change in pressure of 1 mm. represents

$$\frac{273 \times 4.30 \times 6.06 \times 10^{23}}{760 \times 293 \times 22.4} = 1.42 \times 10^{20} \text{ molecules of oxygen}$$

or

$$\frac{273 \times 4.30 \times 32}{760 \times 293 \times 22.4} = .00753 \text{ grams of oxygen.}$$

Denoting the rate of decrease of pressure in millimeters per minute by  $R$ , the current in amperes by  $I$ , and the voltage drop through the positive column by  $V$ , the yield of ozone in grams per kw. hr. is

$$Y = .00753 \times 60 \times 10^3 \times R/IV = 451 R/IV \text{ grams per kw. hr.}$$

The number of ozone molecules formed per electron of current is

$$M = \frac{2}{3} \times 1.42 \times 10^{20} \times 1/60 \times 1.50 \times 10^{-19} \times R/I \\ = .252 R/I \text{ molecules of ozone per electron.}$$

The current as measured by a milliammeter is assumed to be the electronic current within the positive column, since the velocity of the positive ions as compared to electrons is negligible. The rate of reaction can be found from the slope of the time-pressure curve for constant current;  $M$  may be calculated by substituting in the above expression.

The energy necessary to form one ozone molecule in the discharge is

$$v = \frac{V}{M} = \frac{V \times I}{.252 \times R} = 3.97 \frac{IV}{R} \text{ electron volts per molecule.}$$

Little is known about the actual number of ions formed by an electron in traversing the positive column of a discharge, but an upper limit for this value may be found by dividing the fall of potential through the positive column by the ionization potential of the gas. For oxygen, the maximum number of ions that can be formed per electron is

$$N_{\max} = \frac{V}{14.2} \text{ ions per electron.}$$

From this the minimum  $M/N$  ratio is

$$\left(\frac{M}{N}\right)_{\min} \text{ or } \frac{M}{N_{\max}} = \frac{.252R/I}{V/14.2} = 3.58 \frac{R}{IV} \text{ molecules per ion}$$

It is apparent that the foregoing computations involve no assumptions as to the mechanism of ionization or of the resultant chemical action.

Table I illustrates the various values of  $Y$ ,  $M$ ,  $N_{\max}$ ,  $(M/N)_{\min}$ , and  $v$  obtained at different pressures from the data in Fig. 2.

TABLE I

Pressure (mm.)	$R$	$I$	$V$	$Y$	$M$	$N_{\max}$	$v$	$(M/N)_{\min}$
13	1.30	.020	440	66.8	16.4	31.0	26.8	.528
9	1.45	.020	420	78.0	18.3	29.6	22.9	.618
5	1.58	.020	350	101.0	19.9	24.6	18.5	.809
1	1.60	.020	315	114.0	20.2	22.2	15.6	.910
0.5	0.48	.020	215	50.0	6.0	15.2	35.8	.395

The table shows that as the pressure decreases the yield and  $(M/N)_{\min}$  increase to a maximum at 1 mm. At this pressure the energy expended in producing one ozone molecule is 15.6 electron volts, an amount slightly greater than the ionization potential of oxygen. Line 1 of Fig. 3, however, represents a higher yield than could be obtained in the type of experiment recorded in the table. In this case at low initial pressures and for low current densities an efficiency of 11.9 electron volts per ozone molecule was obtained, which is equivalent to  $(M/N)_{\min} = 1.19$ .

#### Discussion of Results

While conditions in the positive column in general may be said to resemble those in the negative glow, a very marked difference arises in virtue of the fact that the potential gradient through which an electron falls before entering the negative glow from the Crookes dark space is several hundred times that to be found along the positive column. For this reason the method employed in the previous papers of this series for computing the number of positive ions formed in the region wherein synthesis takes place cannot be applied here. The effect of this marked difference in potential gradients causes the present results to differ in that the rate is not quite independent of the pressure, in that the yield in terms of electron volts is higher, and, especially, in that the rate is proportional to the power input instead of the current.

Some insight into the mechanism involved in the reaction process may be had from a study of the physics of the discharge. As in the negative glow, so within the positive column, are to be found excited molecules, atoms, positive ions, and, in this case, an appreciable concentration of negative ions as well as electrons. Indeed the energy input, or electron energy, of the positive column may be considered as expended in the following ways.

1. In elastic collision
2. In molecular excitation
3. In dissociation into atoms
4. In ionization

Unfortunately none of these expenditures can be evaluated accurately; nevertheless it is possible to make some reasonable assumptions as to their values. It is definite that in the end all the energy consumed appears as heat or as chemical energy in the ozone formation.

A lower limit for the energy lost in elastic impacts may be computed by assuming the fractional loss per collision to be  $2m/M$ , where  $m$  and  $M$  are the masses of the electron and molecule respectively. Such a computation involves the assumption that there is no affinity between an electron and a neutral molecule, which is not justifiable for oxygen. The values of 10% at 8.0 mm., and about 1% at 1.0 mm., thus computed, are low by several fold.

The energy expended in excitation and dissociation may be approximated by the intensities of the characteristic spectra. Johnson<sup>6</sup> and Locknow<sup>7</sup> have

<sup>6</sup> Proc. Roy. Soc., 105A, 683 (1924).

<sup>7</sup> Astrophys. J., 63, 205 (1926).

shown that excitation in the glow discharge operated on D.C. or 60 cycle A.C., for pure oxygen gives a series of bands in the positive column known as the first negative system, extending from 4870 Å in the visible to 2313 Å in the ultra-violet. Steubing<sup>8</sup> has further shown the presence of a series of bands in the extreme ultra-violet covering the region from 1831 Å-1919 Å, which are found in both the positive column and negative glow and also in absorption. This is generally referred to as the ozone-forming region. In addition to these bands the "second negative band system" consisting of bands ranging from 6853 Å to 4955 Å is excited in the high frequency discharge and occurs also with the atomic excitation in the negative glow, especially at pressures below 2 mm. The intensity of the emission decreases with increasing gas pressure due to the increased loss of energy in elastic impacts, as was pointed out in the preceding paragraph.

The intensities of the various bands have been shown by Johnson to be fairly uniformly distributed over the entire quartz violet region. The high intensity of these bands indicates that the energy consumed in excitation constitutes an appreciable fraction of the total energy input.

Crew and Hulbert<sup>9</sup> have shown that dissociation in oxygen is inappreciable above about 0.5 mm., and further that the dissociation is nearly independent of the power input.

An attempt was made to confirm these results by measuring the change in pressure other than that due to temperature. Since the discharge filled but a portion of the tube, only the order of magnitude of the dissociation could be measured. The percent dissociation at pressures above 1 mm. for D.C. and A.C. currents was low; the dissociation was considerably higher for the high frequency discharge and appeared to involve a large fraction of the molecules in the path of the discharge. The amount of energy expended in dissociation at pressures above 1 mm. with the D.C. discharge used in the ozone experiments, however, cannot amount to more than a few percent of the entire energy input.

Since the voltage drop and ionization potential of oxygen are both known, an upper limit can be given for the number of positive ions formed per electron of current, this number being obtained by dividing the potential drop through the column by the ionization potential of oxygen. An exact determination, however, cannot be made, since the energy lost in non-ionizing impacts is indefinite. The actual number of positive ions formed per electron, in view of the above considerations, may fall below this upper limit by as much as 50 per cent.

The distribution of ions in the positive column is determined by the potential gradients. Since the gradient is uniform throughout the length of the tube, except for local variations in the case of striations, the production of ions per unit length is constant. This accounts for the observed fact that the rate of chemical action is proportional to the length of column immersed.

<sup>8</sup> Ann. Physik, (4), 33, 553 (1910).

<sup>9</sup> Phys. Rev., (2), 30, 124 (1927)

The concentration of positive and negative ions per unit volume is also constant except for a very thin layer adjacent to the walls. The negative ions because of their greater mobility will diffuse to the walls more readily than will the positive, building up a negative charge on the walls sufficient to counteract the difference in mobility. The neutralization of ions on the walls of the tube increases as the bore of the tube is diminished. The increased yield observed for tubes of large bore indicates that ions thus neutralized may not contribute to ozone formation.

The rate of ion formation is also very nearly independent of the pressure over a comparatively wide range. This is a result of the fact that while the potential gradient is a direct function of the pressure, the electronic mobility is such a decreasing function of the pressure that the rate of production of positive ions remains quite constant, thus accounting for the linearity in the time-pressure relationship.

It is obvious from the foregoing discussion that the synthesis of ozone, like that of ammonia and nitrogen dioxide, is due largely if not entirely to positive ions. Since atoms and radiation in the extreme ultra-violet are present in the discharge the possibility exists that both atomic and photochemical mechanisms are also in evidence. Fortunately it is possible to give an idea of the relative efficiencies of these various processes.

If neutral atoms contributed to the observed yield the effect must be small at pressures above 1 mm., due to the low atomic concentration. The fact that the rate of synthesis fell rapidly to zero in the region where the atomic concentration was increasing indicates that neutral atoms are comparatively inactive in the reaction process.

The design of the apparatus was such that a direct test could be made for the amount of ozone produced by radiation. This was accomplished by placing the liquid air in the usual position and passing the discharge between the electrodes in the upper portion of the tube in such a manner that the radiation passed directly into the cooled region. Various combinations of electrodes were tried in which the effect of radiation from the positive column, from the negative glow, and from the entire discharge were tested. D.C., 60 cycle, and high frequency discharges were used. In no instance could a detectable amount of ozone be frozen out when the discharge itself did not take place in the portion of the tube immersed in liquid air. In these tests the intensity of radiation entering the cooled region must have been as great as that produced under normal operating conditions. It may be concluded, therefore, that if ozone is formed by the radiation produced in the discharge, the efficiency of this process is very low, not of the same order of magnitude as that for positive ions.

A determination of the ratio of ozone molecules formed to the number of  $O_2^+$  ions reacting involves a probable maximum uncertainty of about two-fold. The possible variation in the number of positive ions formed per electron of current has been discussed. There are two other uncertainties, namely, the loss of ions to processes other than the formation of ozone, and the decomposition of ozone whether in the gas phase or on the walls. The latter of

these uncertainties has been shown to be negligible at low pressures and current densities. The former, however, must amount to several percent, for it includes those ions which contribute to the positive ion current as well as the ions which diffuse to the walls or become neutralized without inducing ozone formation.

In referring to the table it will be seen that the lower limit for the ratio  $M/N$  is close to 1, whereas somewhat larger values than 1 are obtained under more favorable conditions. The value of  $N$  used assumes that the entire energy input goes into the production of ions, which, as has been pointed out, is necessarily incorrect, yielding too large a value possibly by as much as 50 per cent. Making reasonable assumptions as to the energy dissipated in processes other than ozone formation a value is obtained of the order of  $M/N = 2$ . Since it is impossible to obtain ratios between 1 and 2 by any simple mechanism, this seems the most probable value. The ratio  $M/N = 1.5$  obtained by Lind is in line with the contention that the true value is nearer 2 than 1.

These considerations are in reasonable agreement with the results of J. B. Johnson<sup>10</sup> who has shown that the energy lost in the ionization process is appreciable; the number of ions produced by a 100 volt electron, for instance, is two and one-half observed, and four calculated. This correction when applied to the results of Busse and Daniels<sup>2</sup> would yield an  $M/N$  ratio of about 2, while the ratio obtained by Hunt<sup>3</sup> would be raised to nearly 1.

In view of the results presented in this paper the most probable mechanism for ozone formation should not involve atoms nor excited molecules and should have a yield given by  $M/N = 2$ . Also the high rate demands simplicity. These demands can best be met by a cluster mechanism. A possible mechanism, therefore, may be written:

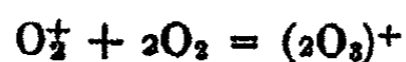

For gas phase neutralization

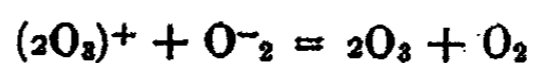

For wall neutralization

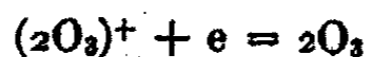

An alternative mechanism is

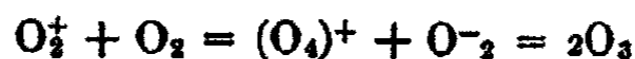

In advancing a cluster mechanism it is necessary to assume that in cases where chemical action is possible the stability of a cluster is greater than would be calculated by the J. J. Thomson<sup>11</sup> method, wherein ions and molecules are treated as charged and uncharged conducting spheres. Since some time is required for the necessary clusters to build up, the probability of premature wall neutralization increases for decreasing tube bore, and for low total or partial pressures of oxygen.

<sup>10</sup> Phys. Rev., (2) 10, 609 (1917).

<sup>11</sup> J. J. Thomson: Phil. Mag., 47, 337 (1924).



### Summary

The rate of synthesis of ozone in the positive column of the glow discharge at constant current is nearly independent of pressure from 15 to 0.3 mm., but is proportional to the power input for low pressures and current densities. The amount of ozone synthesized maximum efficiency, is proportional to the number of positive ions formed, the discharge yielding, at one ozone molecule per 11.9 electron volts or 150 grams per kw. hr. The minimum M/N ratio is thus greater than one molecule per ion. No detectable synthesis can be attributed to neutral oxygen atoms or to radiation produced in the discharge.

The effect of foreign gases is to decrease the yield. Nitrogen is most pronounced in this respect and shows no positive catalytic activity whatsoever. Argon decreases the yield nearly in proportion to the amount present. Helium in small percentages slightly enhances the yield.

18-81.

## A VACUUM TUBE POTENTIOMETER FOR THE DETERMINATION OF THE TRUE E.M.F. OF A HIGH-RESISTANCE CELL

BY RUSSEL J. FOSBINDER

The recent development by MacInnes and Dole<sup>1</sup> of a new type of glass electrode has greatly enhanced its value for the determination of the pH of fluids. The universal use of the system is, however, limited by the usual difficulties encountered in measuring the electromotive force of a high resistance cell. Various types of electrometers have been employed as null instruments but they are expensive and difficult to use in a routine fashion. This paper describes a single-tube direct-current amplifier whose chief attributes are simplicity, stability, high sensitivity, and ease of control. A null method is employed and at balance no current is drawn from the cell, thus permitting the determination of the true E.M.F. of the system. With a galvanometer having a sensitivity of  $2.5 \times 10^{-8}$  amperes a deflection of 15 mm. for a millivolt change of the potential on the grid is obtained. This sensitivity permits the determination of an E.M.F. with an accuracy of  $\pm .0001$  volt, providing the resistance of the cell satisfies a condition discussed in a subsequent portion of the paper.

Recently several papers<sup>2</sup> have appeared in the literature describing vacuum tube potentiometers for use with high resistance cells. The fault, common to all, is that at balance a current flows in the grid circuit causing an IR drop in the cell and possibly a polarization. This fact, of course, limits their usefulness if one is interested in determining the true E.M.F. of the cell.

A perfect vacuum tube should have no grid current at a bias of 0 grid volts but the presence of gas in the tube alters the grid current so that uniformly no grid current flows when the applied biasing voltage is equal to the potential assumed by the grid on open circuit (i.e., with an infinite resistance in series with the grid). Mulder and Razek,<sup>3</sup> taking advantage of the gas effect, have perfected a high grid resistor amplifier of very high sensitivity. Partridge<sup>3b</sup> described a circuit in which he chose as his operating point a plate current corresponding to the grid biased to the negative filament lead, stating that "the maximum current taken from the cell is of the order of  $10^{-9}$  ampere— at 'balance' it is zero." In general, this statement is not valid as it implied the fulfilment of certain demands. Some of these are (1) the electron current to the grid must be equal and opposite to the positive ion current when the grid potential is zero, (2) with a given tube this will be true for a particular value of plate potential and filament current, (3) any change in either fila-

<sup>1</sup> Ind. Eng. Chem. (Analytical Edition), 1, 57 (1929); J. Gen. Physiol., 12, 805 (1929); J. Am. Chem. Soc., 52, 29 (1930).

<sup>2</sup> (a) Elder and Wright: Proc. Nat. Acad. Sci., 14, 936 (1928); (b) Partridge: J. Am. Chem. Soc., 51, 1 (1929); (c) Stadie: J. Biol. Chem., 83, 477 (1929); (d) Elder: J. Am. Chem. Soc., 51, 3266 (1929).

<sup>3</sup> J. Opt. Soc. America and Rev. Sci. Inst., 18, 466 (1929).

1294

ment current or plate potential will cause an excess of electron current or an excess of positive ion current, leaving a net current thru the chemical cell at 'balance' which is not zero and will therefore introduce an error in the measurement equal to the IR drop of this net grid current thru the cell resistance. Thus it seems that the claim made by Partridge that "it (the amplifier system) is independent of the characteristics of the valves and of their power supply," should be qualified. Elder<sup>2d</sup> and Elder and Wright<sup>2a</sup> operated their circuit with a grid current flowing, consequently the observed E.M.F. of the cell varied with the resistance. This fault was recognized by Elder by a comparison of the observed E.M.F.'s obtained with the electrometer with those obtained with the vacuum tube potentiometer. A subsequent discussion will show that  $E_g$  may have some value other than 0 when  $i_g = 0$ .

#### The Vacuum Tube Amplifier as a Null Instrument<sup>4</sup>

The method of operating a practical circuit with no grid current flowing\* at balance involves a discussion of the plate current—grid voltage and the grid current—grid voltage characteristics of a tube.

Since the sensitivity of the circuit is dependent on the grid impedance  $Z_g$  one must consider the factors which operate to produce a change in the magnitude of this quantity. There are three main causes for decreasing the grid resistance, namely: (a) leakage currents, (b) grid electron current and (c) ion grid current resulting from the ionization of gas in the tube.

The components of the grid current characteristics are represented by Figs. 1a, 1b, and 1c;<sup>5</sup> however, in reality all three exist simultaneously and the characteristic takes the form indicated in Fig. 2. The equation for the flat portion having a positive slope is

$$i_g = i_0 + m E_g \quad (1)$$

where

$i_g$  = grid current

$i_0$  = constant

$m$  = slope

$E_g$  = grid voltage

When  $i_g = 0$ ,  $m = i_0/E_g$  and since  $m = 1/Z_g$  one can easily see that  $Z_g$  is positive and will be fairly large at this point.

Two plate current-grid voltage curves are indicated in Fig. 3. The normal characteristic may be represented by  $i_p = f(E_g)$ . The introduction of a high resistance in the grid circuit alters the slope of the characteristic and the plate current is now represented by  $i_p = f(E)$ .

Direct current amplification depends on a relay effect of the electron tube, that is to say, a variation  $\Delta E_g$  of the grid potential produces a variation

<sup>4</sup> A more complete discussion of this and other similar vacuum tube circuits can be found in the paper by W. B. Nottingham: J. Franklin Inst., March (1930). It has been the writer's privilege to read parts of the manuscript before publication.

\* The value of  $E_g = E_{0g}$ , i. e. where  $i_g = 0$  has been designated as the floating potential by Nottingham: J. Franklin Inst., 208, 469 (1929).

<sup>5</sup> Figs. 1a, 1b, 1c, 2, and 3 have been taken from a paper by Ebbe Rasmussen: Ann. Physik, 2, 357 (1929).

$\Delta i_p$  in the plate current. The relationship is called the mutual conductance  $G$  of the tube, and is generally very small, about  $10^{-3}$  amp/volt. For a particular value of  $E_g$  and of  $E$  respectively we have  $G = \frac{\partial i_p}{\partial E_g}$  and  $G' = \frac{\partial i_p}{\partial E}$ ,  $G'$  being the effective mutual conductance. Again considering the plate current-grid voltage characteristic when  $Z_g$  is positive, the inclusion of progres-

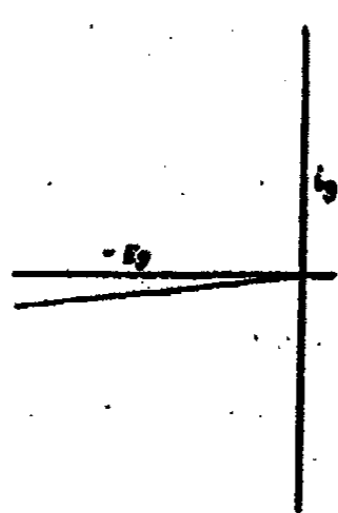

FIG. 1a

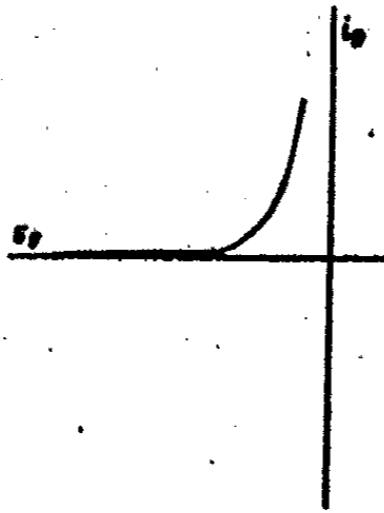

FIG. 1b

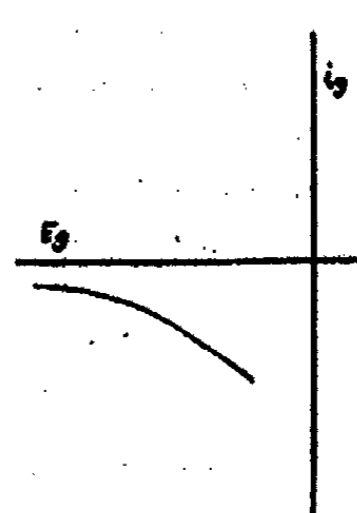

FIG. 1c

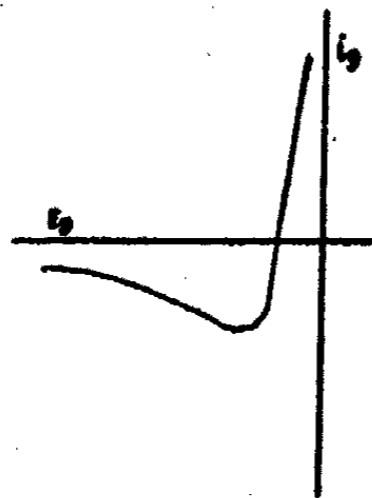

FIG. 2

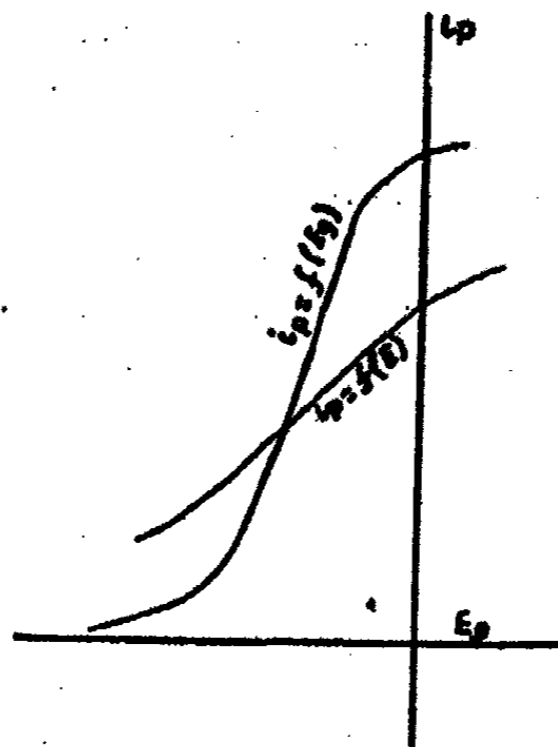

FIG. 3

sively higher resistances in the grid circuit continuously decreases the slope, i.e., the value of  $G'$  decreases. Further, the curves will intersect the normal characteristic at the same point, corresponding to 0 grid current, i.e., when the grid current changes sign. Finally, when the grid is on open circuit, that is to say  $R_g = \infty$ , a free grid appears at the same potential corresponding to  $i_g = 0$ .

Referring to the circuit sketched in Fig. 4 we have a relationship given by

$$E = E_g + R^{(2)}i_g$$

$$\text{or } E_g = E - R^{(2)}i_g$$

$$\text{when } E_g = E_{0g} = \text{floating potential}$$

$$i_g = 0$$

and

$$i_o + \frac{E_{og}}{Z_g} = 0$$

therefore

$$i_g = \frac{E_g - E_{og}}{Z_g}$$

$$E_g = E - R \left( \frac{E_g - E_{og}}{Z_g} \right)$$

$$E_g \left( 1 + \frac{R}{Z_g} \right) = E + \frac{E_{og}}{Z_g} R$$

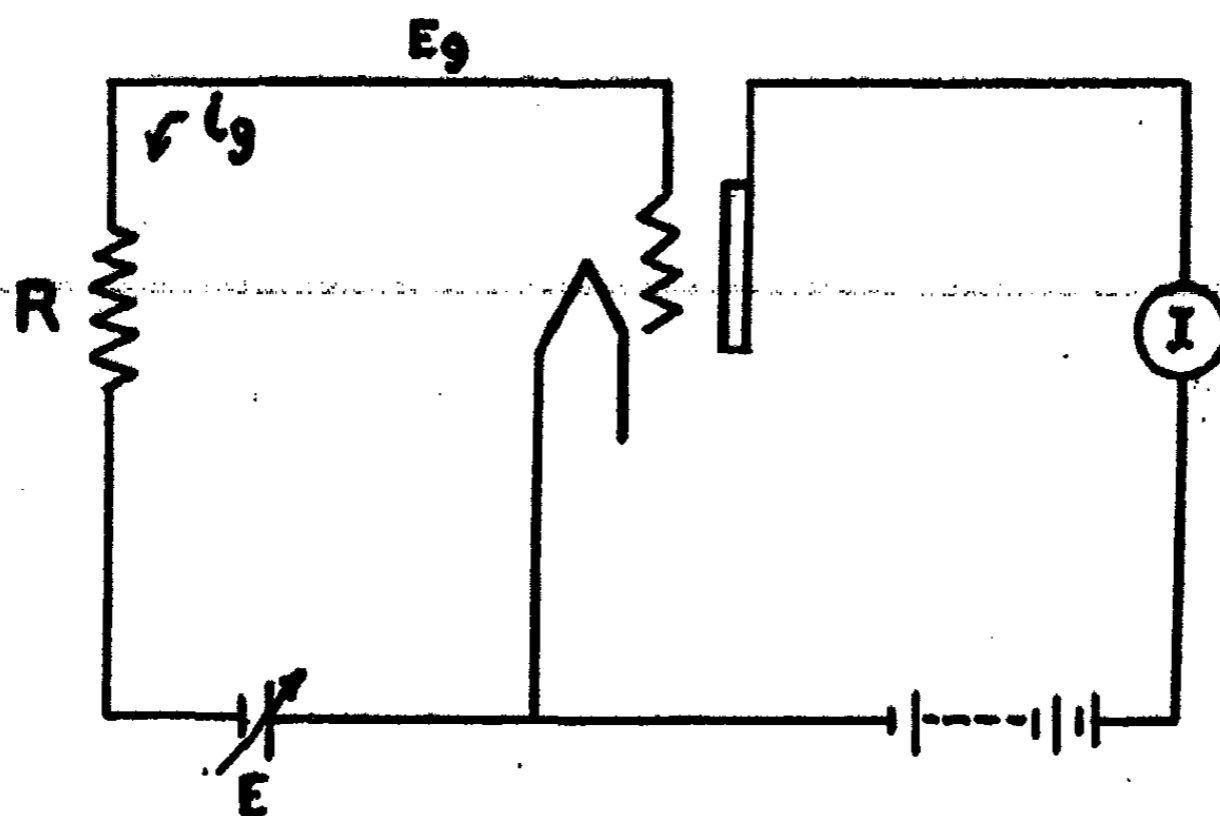

FIG. 4

Differentiating and considering the last term a constant we have

$$\frac{\partial E_g}{\partial E} = \frac{1}{1 + R/Z_g} = \frac{Z_g}{Z_g + R} \tag{3}$$

now  $\frac{\partial E_g}{\partial E} = \frac{\partial E_g}{\partial i_p} / \frac{\partial E}{\partial i_p} = \frac{G'}{G} = \frac{Z_g}{Z_g + R} \tag{4}$

or  $G' = G \frac{Z_g}{Z_g + R} \tag{5}$

From this relationship it is seen that  $G'$  will be equal to  $G$  when  $\frac{Z_g}{Z_g + R} = 1$  or when  $Z_g \gg R$ .

If a potentiometer be inserted in the grid circuit to balance the e.m.f. of the cell and if

$e$  = amount by which the circuit is unbalanced

$e'$  = fraction of  $e$  which gets thru to the grid

than  $\frac{\partial e'}{\partial e} = \frac{Z_g}{Z_g + R}$  which also shows that  $R$  must be small compared to  $Z_g$  if the

sensitivity is to be retained. The above relationship also indicates that if  $e$  is to be determined with an accuracy of  $\pm 0.1$  mv  $E$  must also be controlled with the same accuracy. Finally, it is seen that a compensation carried out thru the resistance  $R$  determines only the potential drop across  $R$  independent of  $Z_g$ —in other words the amplification need not be constant, it need only be sufficient.

Considering the plate circuit containing an external resistance in series we have the relationship

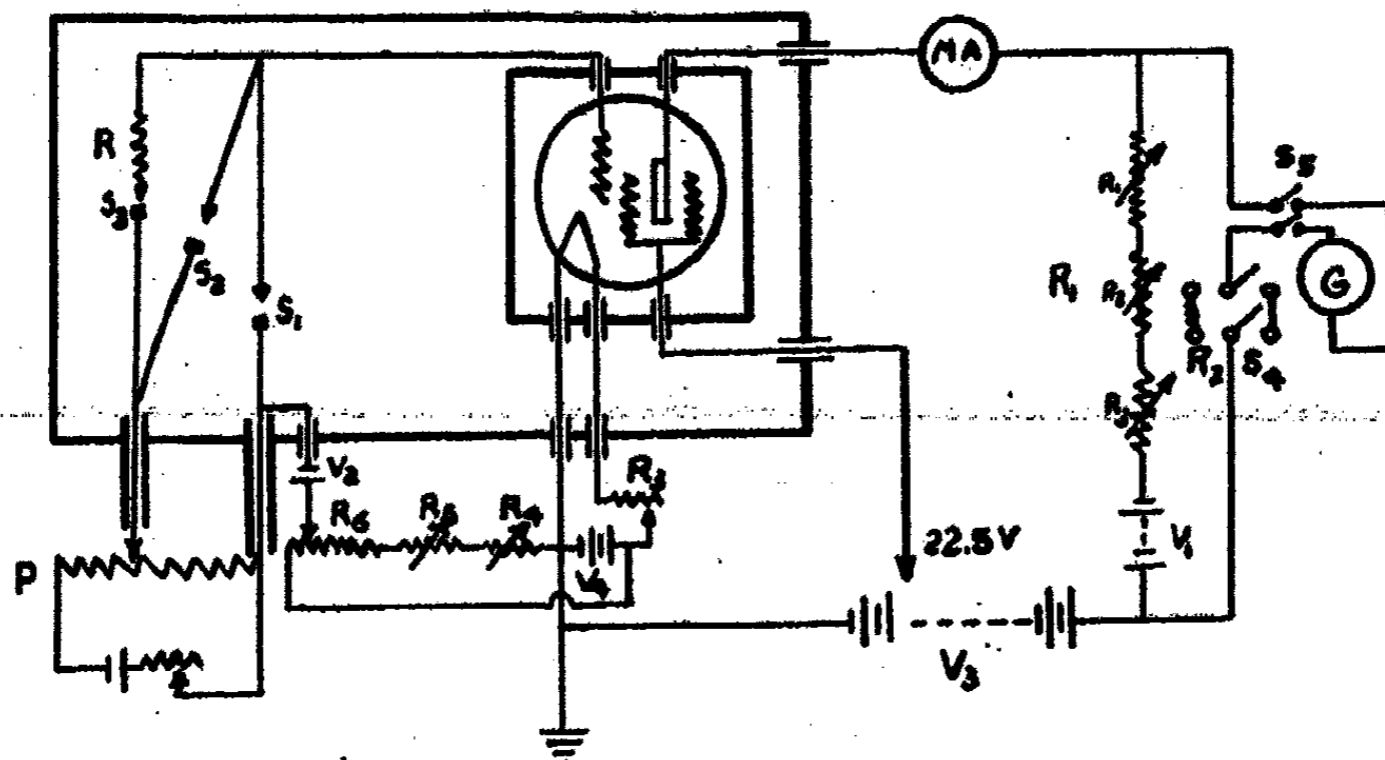

FIG. 5

$$\frac{\partial i_p}{\partial E_g} = G \frac{Z_p}{Z_p + R_p} \tag{6}$$

where  $Z_p$  = plate impedance and the sensitivity

$$\frac{\partial i_p}{\partial E_g} \cdot \frac{\partial E_g}{\partial E} = \frac{\partial i_p}{\partial E} = \frac{G}{1 + R_p/Z_p} \cdot \frac{Z_g}{Z_g + R} \tag{7}$$

The preceding equations refer only to the unbalanced circuit for when

$$i_g = 0, e' = 0, e = 0, \text{ and } E_g = E_{og}.$$

The tube which best fulfills the requirements for the amplifier under discussion is the screen grid type "22," having the additional advantage of a highly isolated control grid.

#### The Practical Amplifier

In order to locate  $E_g = E_{og}$  (i.e. when  $i_p$  does not change on open or closed grid) with the use of a galvanometer as null instrument in the plate circuit it is necessary to employ some form of zero-shunt circuit. The working circuit is shown schematically in Fig. 5. A zero-shunt is obtained by means of the battery  $V_1$  and the variable resistance  $R_1$ . The potentiometer and variable resistances are of the radio type and are conveniently mounted on a

Bakelite panel. In order to avoid electrostatic and capacity effects it is necessary to shield that part of the apparatus which is bounded by a heavy line in the diagram. This is simply done by enclosing the tube, cell, and switches  $S_1$ ,  $S_2$  and  $S_3$  in a large grounded metal box. The tube is further protected by mounting it in its socket in a copper box which is in turn grounded. The tube container is suspended in the large metal box by means of rubber bands in order to reduce vibration effects. A drying agent placed in the box maintains a dry atmosphere surrounding the tube. Leakage currents from the grid to other parts of the tube are minimized by carefully

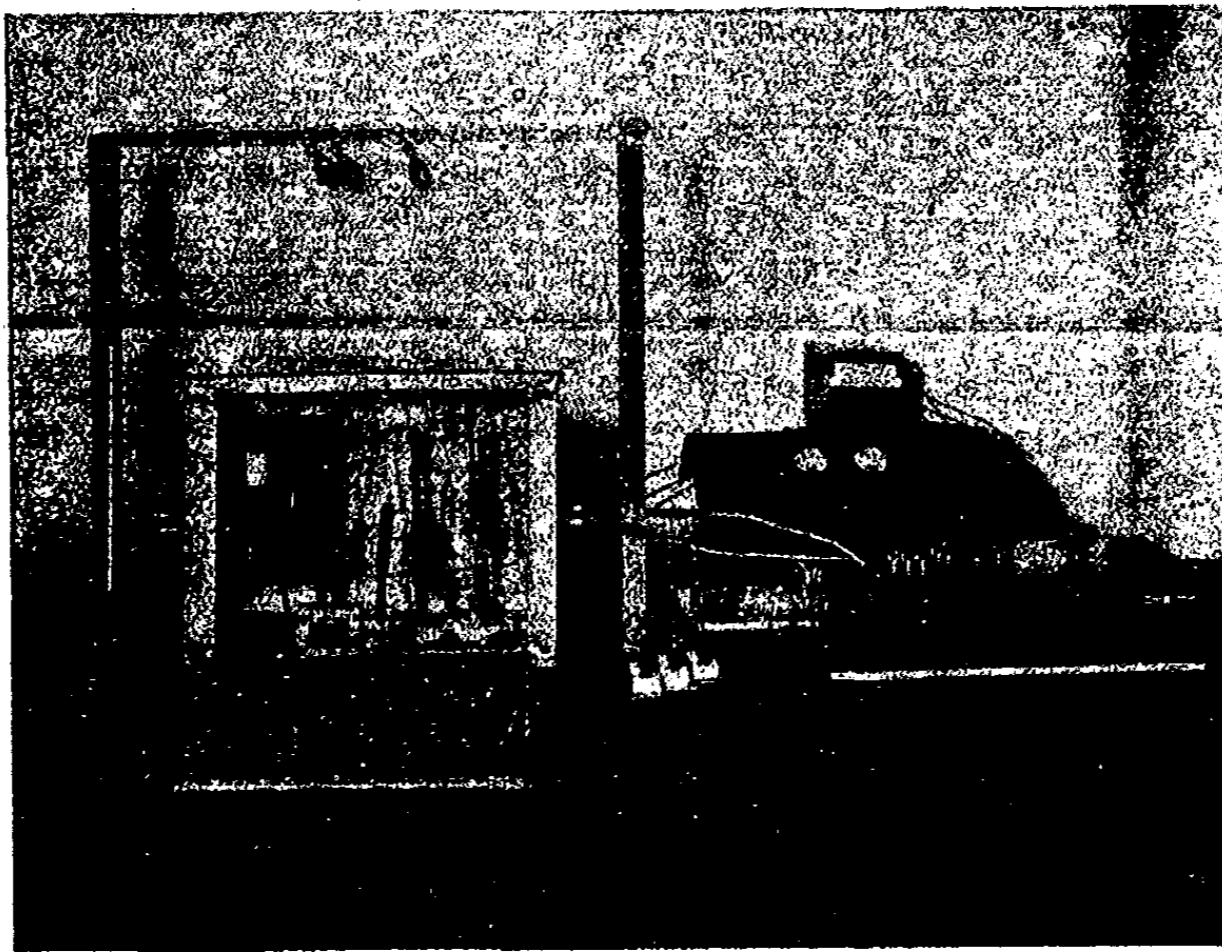

FIG. 6

cleaning the glass surface with absolute alcohol and grounding the point at which the glass comes in contact with the base. All leads to and from the tube, switches, and cell are insulated by means of sulfur. The cell is provided with high insulation as it is supported by two metal clamps which are fastened to glass rods firmly imbedded in a block of sulfur. The switches  $S_1$ ,  $S_2$  and  $S_3$  are insulated with sulfur and to avoid contact potentials all contacts are made of gold. The lead wires from the box to the potentiometer are enclosed in grounded copper tubing and are insulated from the tubes by the use of sulfur. The preceding and many other details of the apparatus are revealed in the accompanying photograph, Fig. 6.

The component parts of the amplifier are given here for reference.

- 1—UX—222 tube
- $V_4$ —1—4 to 6 V storage battery
- $V_3$ —2—45V Heavy duty "B" batteries
- $V_2$ —1 dry cell

- $V_1$ —9 dry cells connected in series-parallel to give 4.5 volts  
 $R_1$  {  $r_1$ —10,000 ohm rheostat  
 $r_2$ —5,000 " " "  
 $r_3$ —100 " " "  
 $R_2$ —100,000 ohm grid resistor  
 $R_3$ —25 ohm rheostat  
 $R_4$ —5 ohm rheostat  
 $R_5$ —200 " " "  
 $R_6$ —2000 ohm potentiometer  
 $S_1, S_2, S_3$ —sulfur insulated switches  
 $S_4$ —double pole double throw switch  
 $G$ —No. 2420 (c) Leeds & Northrup galvanometer  
 $P$ —Leeds & Northrup potentiometer  
 $MA$ —Weston 506 1.5 ma-milliammeter

#### Operation of the Amplifier

To operate the amplifier the plate and filament battery circuits are closed and the filament rheostat adjusted until the plate milliammeter reads 0.5 ma. The tube is then allowed to reach a steady state which usually requires about twenty minutes. With the grid circuit open,  $R_1$  is adjusted until the galvanometer shows no deflection.  $S_1$  is then closed and  $R_{4,5,6}$  adjusted until the galvanometer again reads zero. Upon opening  $S_1$  the galvanometer should show no deflection as  $E_g = E_{og}$ . If a Leeds & Northrup Laboratory H ion potentiometer be used the galvanometer binding posts must be short circuited and the E+ post should always be connected to the biasing battery. To measure the potential of the cell  $R, S_1$  and  $S_2$  are opened,  $S_3$  is closed; the potentiometer key depressed, and the e.m.f. at 0 galvanometer deflection is read directly. The potentiometer is checked against the standard cell by opening  $S_3$ , closing the potentiometer-galvanometer circuit and balancing in the usual manner.

Since only one tube is used the characteristics need not be determined.

The stability of the circuit is remarkably good, a drift of more than 2 mm. per minute never occurring on the plate side. The grid bias is also stable for several minutes before an observable drift occurs. No oscillations of the galvanometer take place and the deflections are well defined.

#### The Determination of the Grid Impedance near Grid Zero

Since the sensitivity of the grid circuit is dependent on the value of the ratio  $\frac{Z_g}{Z_g + R}$  (Equation 3) one should determine the value of the grid impedance very near grid zero. The following method may be employed in determining the value of  $Z_g$  corresponding to a value of  $\Delta E_g = E_g - E_{og}$ .

A known resistance  $R$  is inserted in the grid circuit in place of the cell. A circuit is adjusted, an e.m.f. of one mv is introduced from the potentiometer  $P$  and the galvanometer deflection noted. With the resistance in series an e.m.f. sufficient to give the same galvanometer reading is introduced.



If we let

$e_R$  = e.m.f. with the resistance in series

$e_S$  = e.m.f. without the resistance in series

then

$$e_R = i_g (R + Z_g)$$

$$e_S = i_g Z_g$$

and

$$Z_g = \frac{e_S R}{e_R - e_S}$$

Since  $R$ ,  $e_S$  and  $e_R$  are known,  $Z_g$  may be computed.

Substituting experimentally determined values in the above equation the following result was obtained

$$Z_g = \frac{1 \cdot 10^{-3} \cdot 7.5 \cdot 10^7}{1.6 \cdot 10^{-3}} = 47 \cdot 10^6 \text{ ohms.}$$

If an accuracy of  $\pm 0.1$  mv is desired with the use of this tube the resistance of the cell must, therefore, not exceed 25 megohms.

#### Results with the Glass Electrode

The best test of a circuit is, of course, in its operation in determining the e.m.f. of a high resistance cell. In order to test the reliability of the circuit, the e.m.f.'s of the following cells were determined.



The potential of cell (2) should be equal to that of cell (1) providing the glass functions as a membrane reversible to hydrogen ions and is the source of no other potential. The 0.1N HCl and the silver-silver chloride electrodes were previously checked by the recommended cell combinations and were found to be satisfactory.

The e.m.f.'s of cells (1) and (2) were determined with the vacuum tube potentiometer at 21°C with the following result

$$E_{(1)} = -.0395 \text{ volts}$$

$$E_{(2)} = -.0420 \text{ volts}$$

The difference between  $E_2$  and  $E_1$  ( $-.0025\text{V}$ ) should be equal to the membrane potential existing in the glass. To test this point the e.m.f. of the combination



was determined and found to be .0024V. This procedure was carried out with a number of glass electrodes with similar results

To further test the behavior of the circuit a number of Sørensen phosphate buffer solutions were prepared and the e.m.f.'s of cells of the type

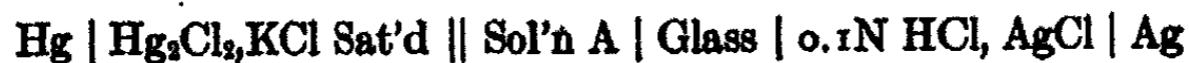

were determined at 21°C.

For the purpose of obtaining comparative values of the e.m.f. of such a cell the potential of the cell



was assumed to be  $-0.3524$  volts at  $21^\circ\text{C}$ . Using the observed value for the e.m.f. of cell (1) the equation relating pH to the observed potential becomes

$$E_{21^\circ} = -0.1023 + 0.0583 \text{ pH}$$

Since the particular glass electrode employed had a membrane potential of  $-0.0024$  volts the potential of cell (2) is given by

$$E_{21^\circ} = -0.1047 + 0.0583 \text{ pH}$$

The results of a series of measurements on the above cell with varying hydrogen ion concentration of solution A are given in the following table.

TABLE I

Calc. E	Obs. E	pH	pH obs.
.2590	.2595	6.23	6.24
.2924	.2902	6.81	6.78
.3256	.3249	7.38	7.38
.3642	.3628	8.04	8.02

The small deviations of the observed from the assumed pH values are to be expected as the exact pH values of the buffer solutions were not determined electrometrically. It is sufficient to show that the observed e.m.f. values are of the correct order of magnitude.

Electrodes of the type described by MacInnes and Dole were employed, the glass being of the same composition, and were approximately 7 mm. in diameter.

The author is indebted to Dr. W. B. Nottingham of the Bartol Research Foundation for many valuable suggestions.

#### Summary

The theory and construction of a vacuum tube potentiometer for determining the true e.m.f. of a high resistance cell have been described. Operating the amplifier under well defined conditions an accuracy of  $\pm 0.001\text{V}$  is obtainable.

*The Cancer Research Laboratories  
of the Graduate School of Medicine  
of the University of Pennsylvania,  
Philadelphia, Pennsylvania.*

18-82.

## THE DISSOCIATION OF STRONG ELECTROLYTES. II\* TWO-PHASE EQUILIBRIA. HEATS OF NEUTRALIZATION

BY MORRIS B. JACOBS AND CECIL V. KING

In this paper it is proposed to discuss the validity of data on the following points as evidence for a theory of complete dissociation of strong electrolytes: (1) the extremely low vapor pressure of the hydrogen halides above their dilute aqueous solutions; (2) the experiments of Hill on the extraction of silver perchlorate from benzene by water; and (3) the supposed equality of the heats of neutralization of strong acids and bases. It will be shown that these data do not support a theory of complete dissociation in preference to one of partial dissociation.

The first reference to the apparent lack of vapor pressure of the hydrogen halides above their dilute aqueous solutions as a support for the theory of complete dissociation seems to have been made by Noyes and MacInnes.<sup>1</sup> From their measurements of ion activities and transference numbers they drew the general conclusion that the conductance ratio does not give a measure of the activity of strong electrolytes and that the activity coefficient is not proportional to the fraction ionized (i.e. the conductance ratio). In discussing this non-agreement, they indicated their belief that a theory of complete dissociation would eliminate these difficulties. They refer to Noyes<sup>2</sup> as giving a summary of evidence for a theory of complete dissociation. Actually the article referred to gives very little evidence for such a theory.<sup>3</sup> They conclude with the following statement:—

"As said above, we cannot here discuss in detail the hypothesis of complete ionization; but in closing it may be pointed out that it accounts for the remarkable facts that so many very dissimilar chemical substances (for example, hydrochloric acid and potassium chloride) seem to be equally ionized, and that a volatile substance like hydrochloric acid does not have an appreciable vapor pressure even in *N* solution where 15% of it must be assumed to be in the un-ionized state, if the conductance ratio is taken as a measure of ionization." (Italics ours).

These statements, as well as those of Noyes concerning the optical activity of the  $\alpha$ -brom camphor sulfonates have been widely quoted, as a few examples will show.

In their "Electrochemistry" Creighton and Fink<sup>4</sup> say: "Hence Noyes and MacInnes deem it advisable to adopt the hypothesis of complete dissociation as a working hypothesis, and to attribute variations in the conductance

\* Contribution from the Department of Chemistry, Washington Square College, New York University.

<sup>1</sup> J. Am. Chem. Soc., 42, 239 (1920).

<sup>2</sup> Science, 20, 582 (1904).

<sup>3</sup> See the first article of this series: J. Phys. Chem., 34, 1013 (1930).

<sup>4</sup> "Electrochemistry," 316 (1928).

ratio,  $\Lambda/\Lambda_0$ , wholly to changes in the mobilities of the ions. In their opinion, this simple hypothesis explains why . . . a volatile substance like hydrogen chloride does not have an appreciable vapor pressure even in a normal solution where according to the conductance ratio, 15% of the acid is undissociated."

V. K. LaMer admits that this lack of vapor pressure may be explained otherwise than by complete dissociation. He says:—<sup>1</sup> "Although not a rigid proof, the fact that aqueous solutions of HCl, HBr and HI exhibit no appreciable vapor pressure of the hydrogen halide<sup>2</sup> below a concentration of 3.0 M strongly indicates the absence of appreciable amounts of the undissociated form."

The evidence under discussion has even found its way into the latest edition of the Encyclopedia Britannica.<sup>3</sup> Under the heading "Electrolysis" and sub-division "The Theory of Complete Dissociation" is found:—

"Further considerations that support the theory of complete dissociation are such general observations as the fact that aqueous solutions of the halogen acids exhibit no appreciable vapour pressure of the hydrogen halide below a concentration of 3 M."

In order to grasp the problem more clearly let us review the principles concerning the vapor pressure of a volatile substance in solution. According to Henry's law, the mass of a gas dissolved by a given volume of a liquid is proportional to the pressure of the gas above the liquid (the temperature being constant).

Nernst,<sup>4</sup> however, added the most important restriction that a constancy in the distribution ratio can exist only between those molecules of the distributed substance which are in the same condition in both phases.

The hydrogen halides are notable exceptions to Henry's law, with their great solubility and extensive ionization. However it is assumed that if there were any un-ionized molecules they would be in equilibrium with the same kind of molecules in the gaseous phase, and follow Nernst's law. It is the failure of that part which has been ordinarily considered un-ionized to follow the Nernst law by giving an appreciable vapor pressure that has been seized upon as evidence for complete dissociation. The exponents of the theory say, in effect, that the vapor phase and the solution must have no molecular species in common; therefore there can be no undissociated molecules remaining in the aqueous solution.

There are two main objections to this solution of the problem. In the first place, the vapor pressure of the hydrogen halides is not actually negligible; and second, in dilute solution they are undoubtedly almost completely combined with water. The first tends to the viewpoint that ionization is greater than that given by the conductance ratio, but not complete; and the

<sup>1</sup>Trans. Am. Electrochem. Soc., 51, 514 (1927).

<sup>2</sup>Bates and Kirschman: J. Am. Chem. Soc., 41, 1991 (1919).

<sup>3</sup>"Encyclopedia Britannica," 8, 322 (1929). The article mentioned was written by William Cecil Dampier-Whetham and John Norman Pring.

<sup>4</sup>Z. physik. Chem., 8, 110 (1891).

second explains the lack of applicability of the Nernst principle, since the solution and gaseous phases would have few molecules of the same species in common even if ionization were far from complete. These viewpoints are presented by the following investigators:

Dunn and Rideal<sup>1</sup> measured the partial vapor pressure of hydrogen chloride in aqueous solution, more recently than Bates and Kirschman (loc. cit.) and by an improved method, and were able to show appreciable vapor pressures down to 0.3M. They concluded: "The present investigation also indicates clearly that, whatever may be the state of the remainder of the solution, at any moment there is a sufficiently large number of hydrogen- and chlorine- ions close enough together to function as undissociated molecules and to be in statistical equilibrium with undissociated hydrogen chloride in the vapour phase at dilutions as low as 0.3M.

"The extreme smallness of the vapour pressure of hydrochloric acid may not justly be used as an argument in favour of the theory of total dissociation, for it must be remembered that the majority of these molecules are in an unactivated form. . . . The formation of large, non-volatile, hydrated complexes at lower temperatures may also be operative in keeping down the partial vapour pressure of hydrogen chloride."

Mitsukuri, Rokkaku and Watase<sup>2</sup> also measured the partial vapor pressure of HCl above its solution, and found it appreciable, though very small, down to the lowest concentration they used, about 0.5M.

Fajans<sup>3</sup> shows that refractometric evidence indicates in 0.01M HCl solution the presence of about 0.01% undissociated molecules. In reply to criticism by Bjerrum, he points out that "the numbers were small, but could not, if they were real, be looked upon as supporting *complete* dissociation; especially since for HCl, for which there was complete agreement as regards the existence of undissociated molecules in the solution, the concentration of  $\text{HCl}_{\text{undiss.}}$  obtained from its partial pressure was still smaller."

It is, then, the opinion of these investigators that the percentage of undissociated HCl, although much smaller than that given by the conductance ratio, is nevertheless real and measurable and therefore that the dissociation is not complete.

The fact is often overlooked that the hydrogen halides are not ionogens in the sense that salts as NaCl, KCl are; the hydrogen halides owe their extensive ionization in aqueous solution *probably entirely to chemical reaction with the water*. That they form isolable hydrates is a well-known fact.<sup>4</sup>

There is absolutely no proof that molecular, undissociated hydrates do not persist at ordinary temperatures and by their stability account for the very low vapor pressures observed.

In 1921 A. E. Hill<sup>5</sup> reported that silver perchlorate,  $\text{AgClO}_4$ , which is readily soluble in a number of organic solvents, is practically completely

<sup>1</sup> J. Chem. Soc., 125, 676 (1924).

<sup>2</sup> Sci. Repts. Tohoku Imp. Univ., 14, 251 (1925).

<sup>3</sup> Trans. Faraday Soc., 23, 376 (1927).

<sup>4</sup> See Landolt-Börnstein Tabellen, pp. 338-340 (1923 edition).

<sup>5</sup> J. Am. Chem. Soc., 43, 254 (1921).

extracted from benzene by water, over a considerable range of concentrations. In discussing the enormous partition coefficient he showed that it could be explained on the basis of absence of common molecular species in the two phases; and that this could be accounted for by (1) complete hydration of the silver perchlorate in the water phase, (2) complete solvation in benzene which would mean absence of a common species in the two phases, or (3) complete dissociation into ions in the water phase. He chose the last as the best explanation of this complete extraction, for no definite stable solvates of silver perchlorate had been isolated up to that time.

These data have not been seized as eagerly by the exponents of the complete dissociation theory as some of the other questionable evidence, for Hill's original viewpoint is easily criticized and was soon shown to be probably erroneous; however, a few examples are found.

Creighton and Fink<sup>1</sup> say:—"Among other points adduced in favor of the hypothesis of complete dissociation may be mentioned the complete extraction of silver perchlorate *from water by benzene.*" (Italics ours.) (Hill's results are, of course, misquoted, as the silver perchlorate is actually completely extracted from benzene by water).

V. K. LaMer<sup>2</sup> says, "... and the same may be said of Hill's experiment in which the salt  $\text{AgClO}_4$  is completely extracted by water from benzene in which it is quite soluble."

Dampier-Whetham and Pring also say in their article in the Encyclopedia Britannica: "Further considerations that support the theory of complete dissociation are . . . experiments which have shown that the salt  $\text{AgClO}_4$  is completely extracted by water from benzene in which it is quite soluble."

Here again we are dealing with a distribution between two phases in equilibrium and exactly the same principles apply as in the distribution between liquid-vapor. First, the concentrations of any single molecular species in the two phases at equilibrium will bear a constant ratio to each other; and second, a constancy in the distribution ratio will exist only between molecules of the distributed substance which are in the same condition in the two phases.

No one appears to have collected and analyzed other data involving the distribution of strong electrolytes in a two-phase system. However, Hill himself has, in later papers<sup>3</sup> presented data which help to solve the present problem. Silver perchlorate forms a hydrate,  $\text{AgClO}_4 \cdot \text{H}_2\text{O}$ , which is stable in contact with the saturated solution up to  $43^\circ\text{C}$ ., and a solvate with benzene,  $\text{AgClO}_4 \cdot \text{C}_6\text{H}_6$ , which is stable in contact with saturated benzene solution up to a much higher temperature. If these or other solvates are the stable components in dilute solutions, there is no molecular species in common in the two layers of the two-phase system and hence the ordinary distribution law cannot be applied.

<sup>1</sup> "Electrochemistry," 316 (1928).

<sup>2</sup> Trans. Am. Electrochem. Soc., 51, 514 (1927).

<sup>3</sup> Hill: J. Am. Chem. Soc., 44, 1163 (1922); Hill and Macy: 46, 1132 (1924).

Hill and Macy investigated the system aniline-water-silver perchlorate, and found that the salt is almost completely extracted by the *aniline* layer from the *water* layer over a wide concentration range. Silver perchlorate forms several solvates with aniline, some of which are remarkably *insoluble in water*. Undoubtedly one or more of these solvates are formed by the salt in contact with aniline and being insoluble in water and too stable to be decomposed by water, they enter and remain in the aniline layer.

Schuncke<sup>1</sup> found that the distribution ratio of hydrogen chloride between water and ethyl ether is similar to that of silver perchlorate between water and benzene, i.e., the HCl is practically completely extracted by the water layer from the ether layer. Here again, it is undoubtedly the formation of a hydrate of HCl, which is stable in the presence of ether and insoluble in ether, which brings about this extraction.

Hantzsch<sup>2</sup> found that chloroform could extract very little dimethyl-ammonium chloride from a concentrated aqueous solution, though the ratio of the solubilities of the salt in the two solvents alone is 7.75 to 1. Hantzsch attributed this behavior to the formation of a water addition product, insoluble in chloroform, though this explanation was criticized by Hill in his first paper on silver perchlorate, water and benzene.

Smirnoff<sup>3</sup> found that tin tetrachloride, SnCl<sub>4</sub>, is at room temperature completely extracted from xylene by water; and that the hydrates of the chloride are insoluble in xylene, although the anhydrous substance is quite soluble. However, between 60 and 110°C. he found reasonable distribution ratios, the hydrates being presumably unstable and somewhat dissociated at these temperatures.

Mueller and Abegg<sup>4</sup> found that boric acid was very much less soluble in amyl alcohol containing a trace of water than in the anhydrous alcohol. Hence the distribution law could not be expected to hold in its ordinary form for the distribution of boric acid between amyl alcohol and water.

Cases of reasonable distribution ratios of a strong electrolyte between water and an immiscible organic liquid are not unknown. Picric acid, very highly ionized in water, is by no means completely extracted by water from benzene, amyl alcohol, bromoform, chloroform, or toluene at ordinary temperatures.<sup>5</sup> Silver nitrate gives ordinary distribution ratios between water and succinic acid nitrile.<sup>6</sup> These liquids are mutually somewhat more soluble than ether and water; several compounds of silver nitrate with the nitrile were isolated, but none with water.

<sup>1</sup> Z. physik. Chem., 14, 331 (1894).

<sup>2</sup> Chem. Zentralblatt, (5) 6II, 922 (1902).

<sup>3</sup> Z. physik. Chem., 58, 373 (1907).

<sup>4</sup> Z. physik. Chem., 57, 513 (1907).

<sup>5</sup> Rothmund and Drucker: Z. physik. Chem., 46, 827 (1903); Landolt-Börnstein Tabellen, pp. 745-747 (1923 edition).

<sup>6</sup> Middleberg: Z. physik. Chem., 43, 305 (1903).

Propyl benzyl methyl phenyl ammonium bromide, a strong electrolyte in water, is partially extracted from water by chloroform. The distribution ratios<sup>1</sup> have values around 0.1-0.7.

Sodium salicylate distributes itself between olive oil and water approximately in the ratio<sup>2</sup> of 1 to 10.

Ferric chloride is almost completely extracted from ether by water. But if the water contains 20% HCl, the ferric chloride is 99% extracted from the water by the ether, though none of the HCl is.<sup>3</sup>

From the above it is quite evident that no one can with certainty interpret abnormal distribution ratios in two-phase systems (liquid-liquid or gas-liquid) in favor of complete dissociation in aqueous solution.

The fact that the heats of neutralization of all strong acids and bases are nearly the same (within a few hundred calories per mole) has occasionally been cited as support for a hypothesis of complete dissociation. G. N. Lewis,<sup>4</sup> in 1908, said:— "It is easy to see why completely dissociated acids and bases should give the same heat of neutralization . . . but half-normal potassium and sodium hydroxides give essentially the same heat of neutralization with an acid, although they are 20% undissociated. Half-normal barium hydroxide gives the same, although 40% undissociated."

Lewis and Randall<sup>5</sup> elaborate upon this subject as follows:—"The old law of the thermo-neutrality of salt solutions, which was a powerful support of Arrhenius' theory of electrolytic dissociation, might perhaps with equal force have been used against his assumption of partial dissociation . . . at higher concentrations we might . . . be led to assume complete dissociation where other criteria may lead us to assume a dissociation of only 50% or less . . . we may state that . . . the partial molal heat contents of all the strong electrolytes, up to a concentration of 0.5 M or greater seem to obey the additivity principle."

This is followed by a footnote:—" . . . in the neutralization of any strong acid, by a strong base, . . . the heat of neutralization is constant within the limits of his (Thomsen's) error. This is true of acids like HCl, HBr and HNO<sub>3</sub>, and of bases like KOH, LiOH and Ba(OH)<sub>2</sub> (whose ionization at 0.5 M is ordinarily assumed to be not over 70%)."

In their book "Thermodynamics" Lewis and Randall<sup>6</sup> practically repeat the above.

If we accept the theory of complete dissociation, we should expect to find exactly the same heat of neutralization for the acids and bases mentioned above. The divergence found by Thomsen is as much as 250 calories, probably more than his experimental error. More recent work has shown conclusively that this divergence is real and about as great as found by Thomsen.

<sup>1</sup> Wedekind and Paschke: *Z. physik. Chem.*, 73, 127 (1910).

<sup>2</sup> Harrass: *Arch. intern. pharmacodynamie et therapie*, 11, 431 (1903).

<sup>3</sup> Mylius and Hüttner: *Ber.*, 44, 1315 (1911).

<sup>4</sup> "The Use and Abuse of the Ionic Theory," *Z. physik. Chem.*, 70, 212 (1909).

<sup>5</sup> *J. Am. Chem. Soc.*, 43, 1112 (1921).

<sup>6</sup> "Thermodynamics," 318 (1923).



For example the work of Richards and Rowe<sup>1</sup> shows definitely that, while the molar heats of neutralization may extrapolate to the same value at infinite dilution, they diverge rapidly at finite concentrations, and keep on diverging the more, the higher the concentration. Thus for the formation of potassium nitrate and sodium nitrate the difference is nearly 240 calories per mole even at a concentration of 1 M. The authors could not reconcile their results with the Arrhenius hypothesis, and certainly not with the theory of complete dissociation.

Richards and Rowe<sup>2</sup> also measured accurately the heats of dilution of a number of strong electrolytes and say that while their results roughly agree with the Arrhenius hypothesis they cannot at all be reconciled with the idea of complete dissociation.

It is well-known that the change in  $\Lambda/\Lambda_0$  with temperature for strong electrolytes is small. This leads to a rather small value for the heat of dissociation. This is supported by the measurements of the heat of ionization of weak acids and bases which is seldom over 1500 calories per mole (the difference between the heat of neutralization by a strong base or acid and that of a strong base by a strong acid.) This rather small heat of ionization, then, might very well account for the comparatively small differences in the heats of neutralization of strong acids and bases whose dissociation varies by as much as 20%. 20% of 1500 calories, or 300 calories, is just outside the figure given above for the divergence of heats of neutralization at a concentration of 1 M.

It is not the wish of the present writers to disparage legitimate use of the complete dissociation theory, but they do wish to discourage the presentation in support of such a theory, of data which are quite unsuitable to test the degree of ionization, and to show that much of the data that has been used for this purpose can equally well be interpreted as a support for partial dissociation. Much evidence has accumulated to show that the conductivity ratio is meaningless as a measure of the dissociation of strong electrolytes; but evidence is also rapidly accumulating to show that the complete dissociation theory is not the "universal panacea" its exponents have hoped it would be.

*New York, N. Y.*

<sup>1</sup> J. Am. Chem. Soc., 44, 684 (1922).

<sup>2</sup> J. Am. Chem. Soc., 43, 770 (1921).

1310

THE DETERMINATION OF VAPOUR AND LIQUID COMPOSITIONS  
IN BINARY SYSTEMS  
II. ACETONE-WATER AT 25°C.

BY W. G. BEARE, G. A. McVICAR AND J. B. FERGUSON\*

In 1900, Taylor<sup>1</sup> made a preliminary investigation of this system at 25°C. and more recently Morton<sup>2</sup> completed a study of it at 20°C. Our own work dealt not only with the vapour and liquid compositions but also with the formula weight of acetone vapour at various pressures and the vapour pressures of dried and of slightly moist acetone at several temperatures.

Apparatus

The original apparatus of Ferguson and Funnell<sup>3</sup> was modified so that the reaction chamber was immersed directly in the large water bath which had one side of plate glass. The temperature of the reaction chamber was thus rendered less dependant upon the fluctuations in the line voltage and less attention was required for a proper temperature control. From the air chamber, copper sheeting was extended to below the water surface and the glass leads thus enclosed. This sheeting was in turn surrounded by a second copper sheath which was separated from the first by a large air space. The glass leads were thus amply protected from the cold air of the room.

The use of the large water bath permitted the stopcock on the vacuum and mercury lines to be re-arranged so that the leads in the former were very desirably shortened. The magnetic hammer, A, and its connecting tubes were moved to the right of the air bath and the lead for the vacuum pump was brought well down into the lower air bath before it emerged. Stopcock, 3, was removed and the mercury in both U tubes was controlled by a single stopcock. (See Ferguson and Funnell, Fig. 1).

The total volume of the vapour was 3477 cc. and the volume of vapour trapped off was 3372 cc. These volumes are not those of the apparatus but those the vapour would occupy if at the temperature of the large air bath and differed from the actual volumes by a small correction. The water bath temperature was read on a Beckmann thermometer which was compared with a standard mercury thermometer which in turn was checked at the transition temperature of Glauber's salt, 32.384°C. The temperature of the water bath was kept constant to  $\pm 0.01^\circ\text{C}$ . The large air bath was usually three degrees hotter than the water bath and kept constant to  $\pm 0.1^\circ\text{C}$ . during the critical periods of each experiment. The upper air bath was maintained at  $50 \pm 0.5^\circ\text{C}$ . The manometer was read to 0.1 mm.

\* This investigation was carried out by Messrs. Beare and McVicar under the direction of Prof. Ferguson.

<sup>1</sup> Taylor: *J. Phys. Chem.*, 4, 355 (1900).

<sup>2</sup> Morton: *J. Phys. Chem.*, 33, 393 (1929).

<sup>3</sup> Ferguson and Funnell: *J. Phys. Chem.*, 33, 1 (1929).

### Procedure

A sample of known weight and composition was distilled into the evacuated apparatus using liquid air as a refrigerant. The mercury columns were adjusted, the liquid air removed and the sample condensed in the reaction chamber. The air and water baths were brought up to their respective temperatures and the gas circulating pump started. After the pressure had been constant for at least an hour, the pump was stopped, the temperatures and pressure read and the sample trapped off by means of the mercury in the U tubes. The sample was then condensed in the small bulb using liquid air, and the bulb sealed off. It was weighed, emptied, dried and re-weighed, allowance being made for the buoyancy of the air. This procedure was found to give slightly more consistent results than that used by Ferguson and Funnell.

### Calculations

The formula weight of acetone vapour was calculated using either the weight of the condensed vapour or the initial weight of the whole sample. In a few experiments, both methods were employed in order to check the experimental procedure.

The vapour compositions and liquid compositions were obtained by the following two methods:

(1) The weight of the total vapour was found from the weight of the vapour condensed, and the weight of the residue was obtained by difference. The composition of the residue was obtained from a total pressure curve and the composition of the vapour then calculated.

(2). The composition of the condensed vapour was calculated from its weight, original volume, temperature, and pressure; first on the assumption that the vapour was a perfect gaseous solution, each component having a normal formula weight, i.e. 18.02 for water and 58.05 for acetone; a correction was then applied based upon the calculated partial pressure of acetone and the formula weight of pure acetone at this pressure. The total weights of the liquid and vapour were obtained as in (1) and the composition of the liquid calculated.

### Materials

(1). Stock acetone, C. A. F. Kahlbaum's best pre-war acetone: Aus der Bisulfit Verbindung. A specific gravity determination gave  $D_4^{20} = 0.79236$ . This indicated a water content of 0.4 percent.<sup>4</sup>

(2). Dried acetone; 150 cc. of the stock acetone was left over 50 grams of pure calcium chloride for three weeks in the cold and shaken at frequent intervals, then decanted off and distilled. The final product had a specific gravity of  $D_4^{20} = 0.79072$ . The following values for dried acetone are given

<sup>4</sup> Young: "Distillation Principles and Processes," 261 (1922).

in the literature: 0.79007,<sup>5</sup> 0.79082,<sup>6</sup> 0.7912,<sup>7</sup> 0.7912,<sup>8</sup> 0.7901<sup>9</sup> and 0.7903.<sup>10</sup> We therefore concluded that our dried acetone was practically free of water.

#### Formula Weight Determinations

The effect of pressure on the formula weight of pure acetone was previously investigated by Sameshima.<sup>11</sup> His results are included with our own in Table I. The variations in Sameshima's results may have been due to the

TABLE I  
The Formula Weight of Pure Acetone

Beare and McVicar 28°C.			Sameshima 25°C.		
Pressure	Formula Weight		Pressure	Formula Weight	
	Method (1)	(2)		uncorr.	corr.*
83 mm	57.82	58.01	56.7 mm	57.99	57.92
125.6	58.41	58.41	58.6	58.47	58.39
132.7		58.42	63.7	58.48	58.39
147.2		58.78	110.7	58.64	58.49
159.8		58.64	114.2	58.37	58.22
191.6		58.79	116.7	58.58	58.42
			124.2	58.45	58.29
			163.4	58.66	58.44
			166.1	59.08	58.86
			174.3	59.06	58.82

\* Corrected by Sameshima using van der Waals' equation.

TABLE II

The Formula Weight of Pure Acetone Vapour calculated from Experimental Results obtained with Stock Acetone

Temperature	Pressure	Formula Weight	
		Method (1)	(Method (2))
29.5°C.	125.1 mm	58.11	58.25
36.2	130.3		58.20
36.1	135.1		58.03
28.2	137.7		58.22
28.2	137.9		57.88
28.3	164.0		58.62
36.1	197.1		58.48
29.0	199.1	58.64	58.96
27.8	203.5	58.84	59.00
36.1	221.9		58.87
28.0	224.4		58.79
28.2	224.9		58.76

<sup>5</sup> International Critical Tables, 3, 27 (1928).

<sup>6</sup> Price: J. Chem. Soc., 115, 1125 (1919).

<sup>7</sup> Reilly and Ralph: Proc. Roy. Dublin Soc., 15, 598 (1919).

<sup>8</sup> Bramley: J. Chem. Soc., 109, 455 (1916).

<sup>9</sup> Perkin: J. Chem. Soc., 45, 478 (1884).

<sup>10</sup> Squibbs: J. Am. Chem. Soc., 17, 187 (1895).

<sup>11</sup> Sameshima: J. Am. Chem. Soc., 40, 1482 (1918).

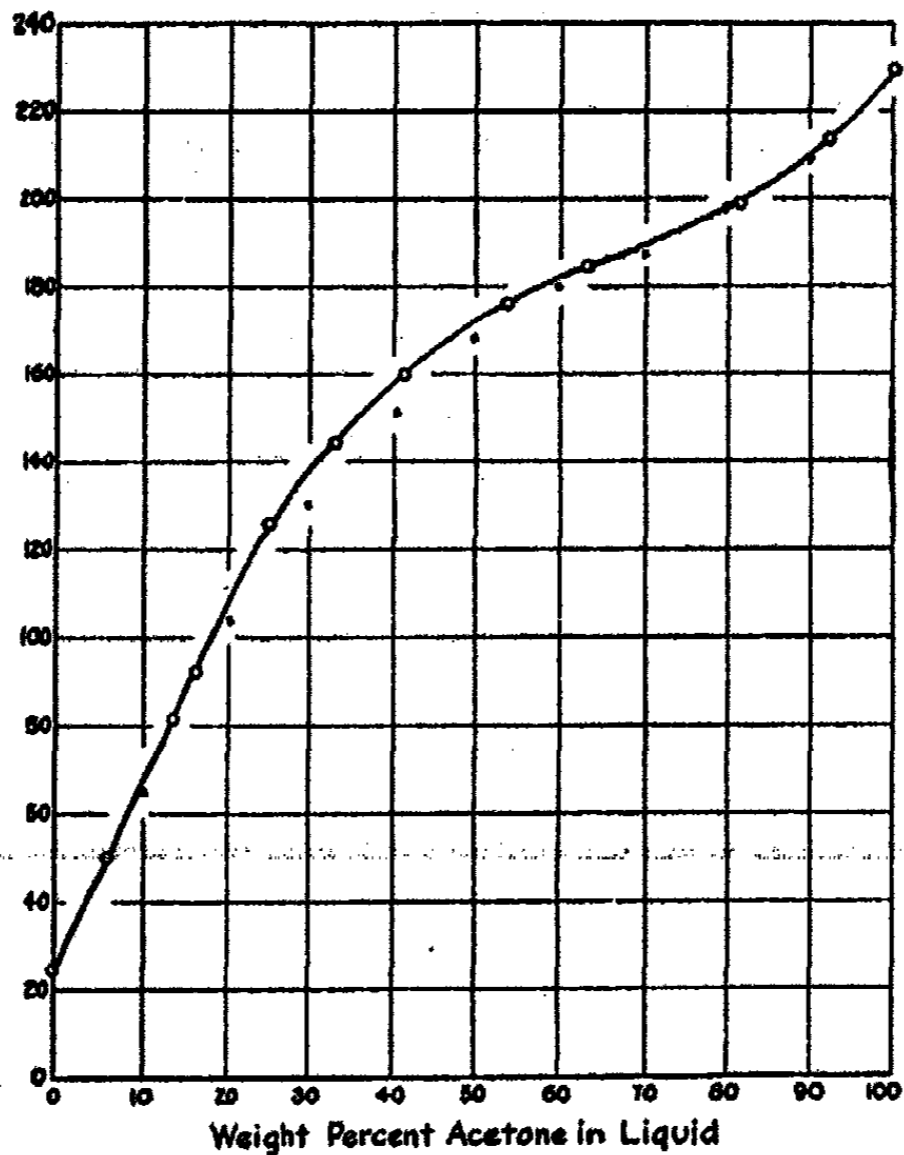

FIG. 1  
System Acetone-Water. Total Pressures at 25°C.

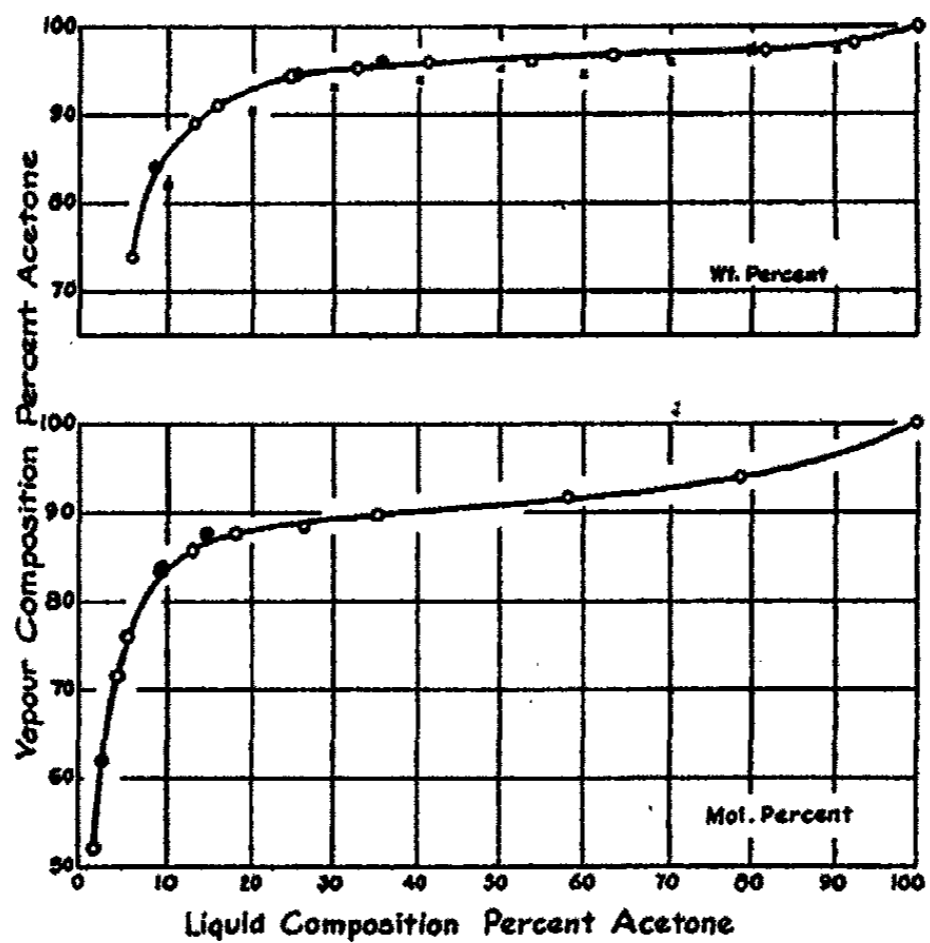

FIG. 2  
The Liquid and Vapour Compositions for the System Acetone-Water at 25°C.

fact that he used very small samples. Variations of similar magnitude were noted by us in our preliminary study in which we used stock acetone and calculated the formula weight of pure acetone vapour on the assumption that the vapour in each experiment was a perfect gaseous solution. We thought that these were due in part to our inexperience and in part to the uncertainty in the water content since a difference of 0.1 wt. percent would cause a difference of 0.2 in the calculated formula weight. These preliminary measurements are given in Table II. Owing to the nature of the relation existing between the vapour and liquid compositions in this system, we found it impossible to get accurate measurements of the formula weight of acetone in mixed vapours containing much water vapour.

#### Vapour Pressure Determinations

The vapour pressure of pure water was determined at 25°C. and found to be 23.7 mm, the value in I.C.T. being 23.756 mm. Our vapour pressure measurements on dry and moist acetone are given in Table III which also includes the measurements of previous workers<sup>12</sup> at the temperatures listed. Same-shima's results are essentially those given in I.C.T. The vapour pressures of

TABLE III  
The Vapour Pressure of Acetone at Various Temperatures

Tempéra- ture	Price	Regnault	Same- shima	Taylor	Beare and McVicar Dried Ac.	Stock Ac.
20°C.	186.3	179.6	184.8	182.5	184.5	183.6
25	232.0		229.2	229.0	229.6	228.0
30	284.6	281.0	282.7	281.0	283.7	282.3
35	348.1		346.4	343.0	347.7	345.7

the solutions are given in the subsequent tables. In figure I, our results and those of Taylor are plotted against liquid composition on a weight percent basis. As the liquid compositions were obtained by method (2), the total pressures curve affords a good check on the concordance of our experimental results. Taylor's results are indicated by the crosses. Pressures are recorded in this paper in millimeters of mercury at 0°C.

#### Vapour and Liquid Compositions

For these experiments, stock acetone (99.6%) was used and allowance was made for the water present. Our results are given in Table IV. The mol. percentages given here are empirical, based upon the formula weights 18.02 for water and 58.05 for acetone. Experiments Nos. 3, 7 and 9 were carried out after the total pressure curve was established and were calculated by method (1). For the other determinations method (2) was employed. The results are given graphically in Fig. 2. The upper curve gives the weight

<sup>12</sup> Price: loc. cit.; Same-shima: loc. cit.; Taylor: loc. cit.; Regnault: Mém. de Paris, 26, 339 (1862).

TABLE IV  
Compositions of Vapours and Liquids in Equilibrium at 25.00°C.

Ref. No.	Sample Weight	Sample Wt. % Ac.	Condensate Weight	Total Pressure	Liquid Comp. Wt. % Ac.	Liquid Comp. Mol. % Ac.	Vapour Comp. Wt. % Ac.	Vapour Comp. Mol. % Ac.
1				23.7	0.00	0.00	0.00	0.00
2	1.7526	20.78	0.3254	50.1	5.98	1.936	77.96	52.34
3			0.4008	61.8	8.7	2.89	84.10	62.12
4	1.7426	43.58	0.5691	81.3	13.15	4.495	89.08	71.68
5	1.5545	55.78	0.6719	91.9	15.93	5.556	91.05	75.91
6	1.5672	77.96	1.0589	126.1	24.59	9.39	94.28	83.51
7			1.0593	126.6	25.3	9.51	94.48	84.16
8	3.0772	61.31	1.2257	144.3	32.70	13.10	95.26	86.18
9			1.3906	150.6	35.6	14.7	95.81	87.68
10	3.0329	69.82	1.3860	159.8	41.27	17.91	95.88	87.82
11	3.0539	78.16	1.5820	176.1	53.76	26.54	96.12	88.56
12	3.1633	83.03	1.8211	184.4	63.45	35.38	96.51	89.54
13	2.9485	92.51	1.8884	199.1	81.68	58.08	97.23	91.58
14	2.8404	96.85	2.0196	213.5	92.17	78.52	98.13	94.21
15				229.6	100	100	100	100

percent acetone while the lower curve gives the empirical mol. percent. Taylor's results are given by crosses on the upper graph. A consideration of our results indicates that several points are a little off the smooth curve. Of these points Nos. 7 and 9 were obtained by method (1) and the deviations may be due to errors in the determination of the liquid composition by means of the total pressure curve. No. 11 appears to be slightly low in acetone and there must have been some accidental error in this experiment. These deviations are hardly noticeable on the weight percent graph but show up more prominently on the mol. percent graph which magnifies these errors.

#### Discussion

Sameshima thought that the increase in the formula weight of acetone vapour with pressure, was caused, in part, by adsorption on the walls of his apparatus which had a volume of 267.91 cc. and was probably constructed of soft glass. He does not give the dimensions of the vapourizing chamber but it is most improbable that the ratio of exposed surface to volume would be similar to the ratios for our apparatus. The latter were 3477/1848 and 3372/1106, respectively, for the total system and for the part cut off by the U tubes. Our apparatus was constructed of Pyrex glass. Although adsorption errors may effect the determinations to the extent of 0.1 to 0.2 in the calculated formula weight, the increase is apparently a real one.

The vapour and liquid compositions are in fair agreement with the earlier results of Taylor. The simple distillation method, used by him, could not be expected to yield exact results especially with solutions weak in acetone. Evidently the distillation method, when carefully used, may yield results which approximately indicate the relations in such a liquid system.

In the ideal case, the product of the total pressure and the mol. fraction of a component in the vapour gives a partial pressure, a simple function of which is a measure of the thermodynamic potential of that component. This partial pressure may then be used to check the experimental results by means of the equation of Duhem-Margules. In practice, the question arises as to whether the calculated partial pressures may legitimately be used in this manner. As a first approximation, we have assumed that the deviations from the behaviour of perfect gaseous solutions shown by the acetone-water vapours are due to the variation in the formula weight of the acetone vapour with pressure. The potential of the acetone in the vapour would then be identical with the potential of pure acetone vapour at the same temperature and at a pressure equal to the partial pressure calculated using the formula weight for acetone vapour corresponding to this pressure.

Now it so happens that the partial pressures calculated in this manner differ but slightly from those calculated using a formula weight of 58.05 for the acetone vapour. This is indicated by the values given in Table V. The former are listed as actual while the latter as empirical partial pressures. One should not conclude that, because these pressures are practically identical, the effect of pressure on the formula weight may be neglected. This would involve the assumption that acetone vapour was a perfect gas, an



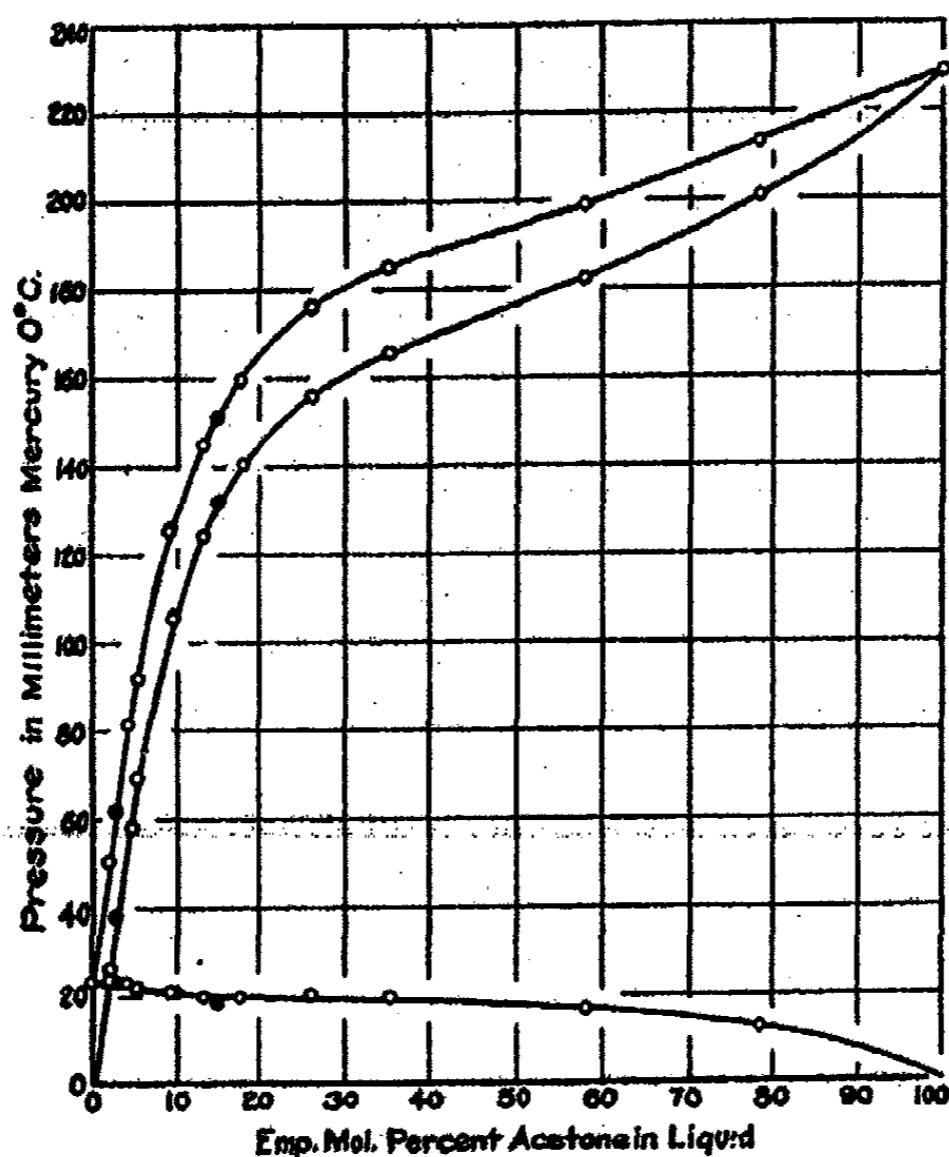

FIG. 3  
Total and Partial Pressures for the System Acetone-Water at 25°C.

TABLE V

The Total and Partial Pressures for the System Acetone-Water at 25°C.

Reference No.	Total Pressure	Empirical pressures water	acetone	Actual pressures water	acetone
1	23.7	23.7	0	23.7	0
2	50.1	23.9	26.2	23.87	26.23
3	61.8	23.4	38.4	23.4	38.41
4	81.3	23.0	58.3	23.0	58.28
5	91.9	22.1	69.8	22.1	69.76
6	126.1	20.8	105.3	20.7	105.4
7	126.6	20.1	106.5	20.0	106.6
8	144.3	19.9	124.4	20.0	124.3
9	150.6	18.6	132.0	18.8	131.8
10	159.8	19.8	140.6	19.5	140.3
11	176.1	20.2	155.9	20.3	155.8
12	184.4	19.3	165.1	19.6	164.8
13	199.1	16.7	182.4	16.9,	182.2
14	213.5	12.4	201.1	12.4	201.1
15	229.6	0	229.6	0	229.6

assumption that a change in formula weight from 58.05 to 58.8 involves a negligible energy change. Since we do not know anything about this energy change, we have plotted our partial pressures against empirical mol. percent acetone in the liquid and these and the total pressures are given in Fig. 3.

Since the experimental errors are magnified by such plotting, the curves are as smooth and as regular as one would expect were there no formula weight complication. They appear to agree with the Duhem-Margules equation, although from the nature of the case the comparison is not an exact one.

#### Summary

The apparatus designed by Ferguson and Funnell has been used to study the system acetone-water. The study included:

- (1). The formula weight of acetone vapour at various pressures.
- (2). The vapour pressures of dried and moist acetone at 20°, 25°, 30° and 35°C.
- (3). The liquid and vapour compositions for the system at 25°C.
- (4). The total pressures at 25°C.

The results are briefly discussed.

*Department of Chemistry,  
University of Toronto,  
October 15, 1929.*

## CALORIMETRIC RESEARCHES ON GEOMETRICAL ISOMERISM

### Part I. Preliminary Studies on Oleic and Elaidic Acids and Esters from a Comparison of their Heats of Combustion

BY L. J. P. KEFFLER

The researches of Baruch,<sup>1</sup> N. and A. Saytzeff<sup>2</sup> and Harries<sup>3</sup> have shown that the formula:



best represented the constitution of oleic acid; and if any doubt could be left, it was completely removed by the synthetic methods of R. Robinson and Mrs. G. M. Robinson<sup>4</sup> and the decomposition methods of Lapworth.<sup>5</sup>

Even though the constitution of oleic acid is known, the question remains of its configuration and its relation to its stereoisomer elaidic acid. Indeed, as Armstrong and Allan put it,<sup>6</sup> "it has been customary to describe oleic acid as the trans-acid for reasons of which we must plead ignorance, though it is usual in other cases of geometrical isomerism, in the absence of definite evidence, to regard the more stable higher melting form as the trans-isomeride, which would therefore lead us to assign this structure to elaidic acid." The same authors point out also that the abundant occurrence of oleic acid is no evidence in itself that it is the most stable form in the chemical sense; that, on the contrary, the absence of elaidic acid in nature is an argument supporting their view, since it is well known that compounds are not in general produced in a form of maximum chemical stability as the result of chemical changes induced by enzyme action in the living cell.

On the other hand, Mrs. G. M. Robinson and R. Robinson<sup>4</sup> have found that stearolic acid may be reduced to oleic acid by means of zinc dust and hydrochloric acid in presence of titanous chloride in acetic acid solution, and inferred from this reaction that oleic acid has the cis-configuration.

Again, T. P. Hilditch<sup>7</sup> has pointed out that in the whole of the reactions which have been employed in the transformation of oleic or elaidic acids into the corresponding dihydro-stearic acids, the higher-melting dihydroxy acid is consistently obtained from elaidic acid and the lower melting dihydroxy-acid from oleic acid, except in the one single case where oxidation has proceeded in presence of aqueous alkali (when the opposite acids are formed.)

Finally, a strong argument in favor of the reciprocal change proposed for the two acids has been supplied by X-ray measurements, carried out and interpreted by Muller and Shearer<sup>8</sup> who ascribed to elaidic acid the formula:

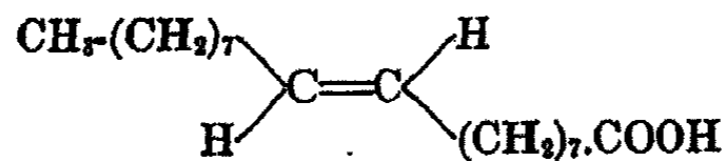

i.e. the trans-form and to oleic acid, the configuration:

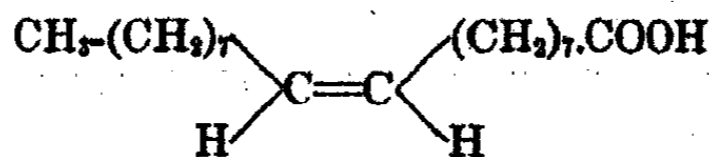

i.e. the cis-form.

The author has now investigated the problem from an entirely different angle, namely, the consideration of the amount of energy stored up in the molecule of each of these acids, as obtained from measurements of their heats of combustion. The determinations of Stohmann<sup>9</sup> had given for the molecular heats of combustion of elaidic acid (cris.) and of oleic acid (liq.) the values 2664.3 and 2682.0 Kg cal., which according to the Landolt-Börnstein Tabellen should be corrected to 2662.5 and 2680.1 Kg cal. respectively. In order to render the value for solid elaidic acid comparable with that of liquid oleic acid, a corrective term of  $52.1 \times 282.3 = 14.707$  gr cal. should be added to the value for the heat of combustion of the former so as to take into account the value for the latent heat of fusion, which is 52.1 gr cal. This gives for the molecular heat of combustion of liquid elaidic acid the value  $2662.5 + 14.7 = 2677.2$  Kg cal. approximately. Thus, according to Stohmann's rule,<sup>10</sup> which has been verified for many pairs of geometrical isomers, and in particular by Roth and Stoermer for the cinnamic series,<sup>11</sup> oleic acid should be considered as the labile isomer, since its heat of combustion is larger than that of elaidic acid.

Unfortunately, however, those determinations were carried out nearly forty years ago, when the calorimetric methods were not susceptible of a high precision. Indeed, it has been shown in several recent papers that the reliability of Stohmann's results, which for several decades had been unquestioned, can no longer be accepted without due caution, as his material was in fact decidedly heterogeneous, the correction factor varying between 1.0031 and 0.9892.<sup>12</sup> Moreover, the two acids under investigation are exceptionally difficult to purify: Hilditch and Lapworth<sup>6</sup> have estimated the amount of impurity in the best samples of oleic acid ever prepared up to 1926 to be between 1% and 2%. Bertram<sup>13</sup> on the other hand, claimed to have prepared oleic acid free from less than 0.5% of its saturated impurities. There is yet another objection to the acceptance of Stohmann's data without caution, since the calculation from them of the molar heat of transformation of the one form into the other gives 16 Kg cal (in round figures), a value which is about double the largest value obtained by various observers for the heat of transformation of very many other geometrical isomers. For example, the values found by Roth and Stoermer, Ossipow, Stohmann, Roth and Wallasch, and Luginin for this quantity were 4.7 (with acids) and 6.5 (with esters); 6.8; 6.2; 6.5 and 8.2 Kg cal respectively.

In particular, for brassidic and erucic acids, whose structures are similar to those of elaidic and oleic acids the molar heat of transformation calculated from the heats of combustion is 7 Kg cal, which is of the order to be expected from the foregoing figures.

From all these considerations it appeared that the problem of the true configuration of oleic and elaidic acids could only be answered—at least from the thermochemical point of view—by new and independent investigations carried out with material of much higher purity than had ever been used before for combustions and using a technique of much greater precision than that available in the days of Stohmann.

I have to express my cordial thanks to Professor Hilditch not only for the loan of 50 grams of such purer material, but also for his help and advice in the preparation of further quantities of oleic acid which were needed.

The combustion results obtained with Professor Hilditch's specimens of the two acids and their methyl esters, are summarised in Tables I to IV.

The water equivalent of the calorimetric system used was 3750 cal<sub>20</sub>. This value holds for an isothermal combustion at the initial temperature of 16.84°C., and applied to the combustion data given in the four tables just mentioned.

The "Constant Range Method" proposed by the author in his first thermochemical communication where the details about the calibration were given in detail, was followed throughout, the constant rise selected being of approximately 3° Beckmann, to which a constant correction of +0.03° had to be applied to convert them into degree centigrades.

#### Discussion and Interpretation of the Results

It is certain that the elaidic acid, owing to its method of purification, by repeated recrystallisation from methyl alcohol, was purer than the 3 other substances whose final purification was carried out by distillation in a vacuum. By adding 52 cal. to the mean value obtained for the heat of combustion of the solid, the value 9396 cal<sub>20</sub> is obtained for its heat of combustion as liquid. This is lower by 9475 - 9396 = 79 cal. than the value obtained for oleic acid immediately after a second redistillation, and lower by 9544 + 2 × 26 - 9396 ± 200 cal. than the extrapolated value obtained for oleic acid after a first redistillation. The large discrepancy observed between the initial values for the same sample of oleic acid after one or two redistillations proves however that this acid, although deserving the name of pure as regards its constancy towards iodine value determinations,\* was not "thermochemically pure," so that the conclusion which might otherwise have been derived from a comparison of the heats of combustion of the two acids as regards their relative stability could only be accepted as provisional. Further, the large difference observed in the case of the acids vanished altogether in the case of the esters, whether these be combusted directly after redistillation or after an interval of two years. The apparent identity between the esters was very striking indeed if it be noted that the divergence was only of the order of 1 in 10000, i.e. less than the experimental error for the four series of combustions. There are two possible explanations, namely (1) some funda-

\* The iodine value of this sample of oleic acid was 90 ± 1, which means that it was incomparably purer than the purest "Kahlbaum" oleic acid, whose iodine value was found to be 73 (theoretical 90.1) and was therefore quite useless for the purpose.

mental difference between the configuration of the acids and that of the corresponding esters, and (2) that Stohmann's rule is only valid for crystallised geometrical isomers.

In addition to the difference in the energy content of the acids and the corresponding esters there may also be noted the difference in the velocity with which the acids and esters change with time. Thus the results in Table

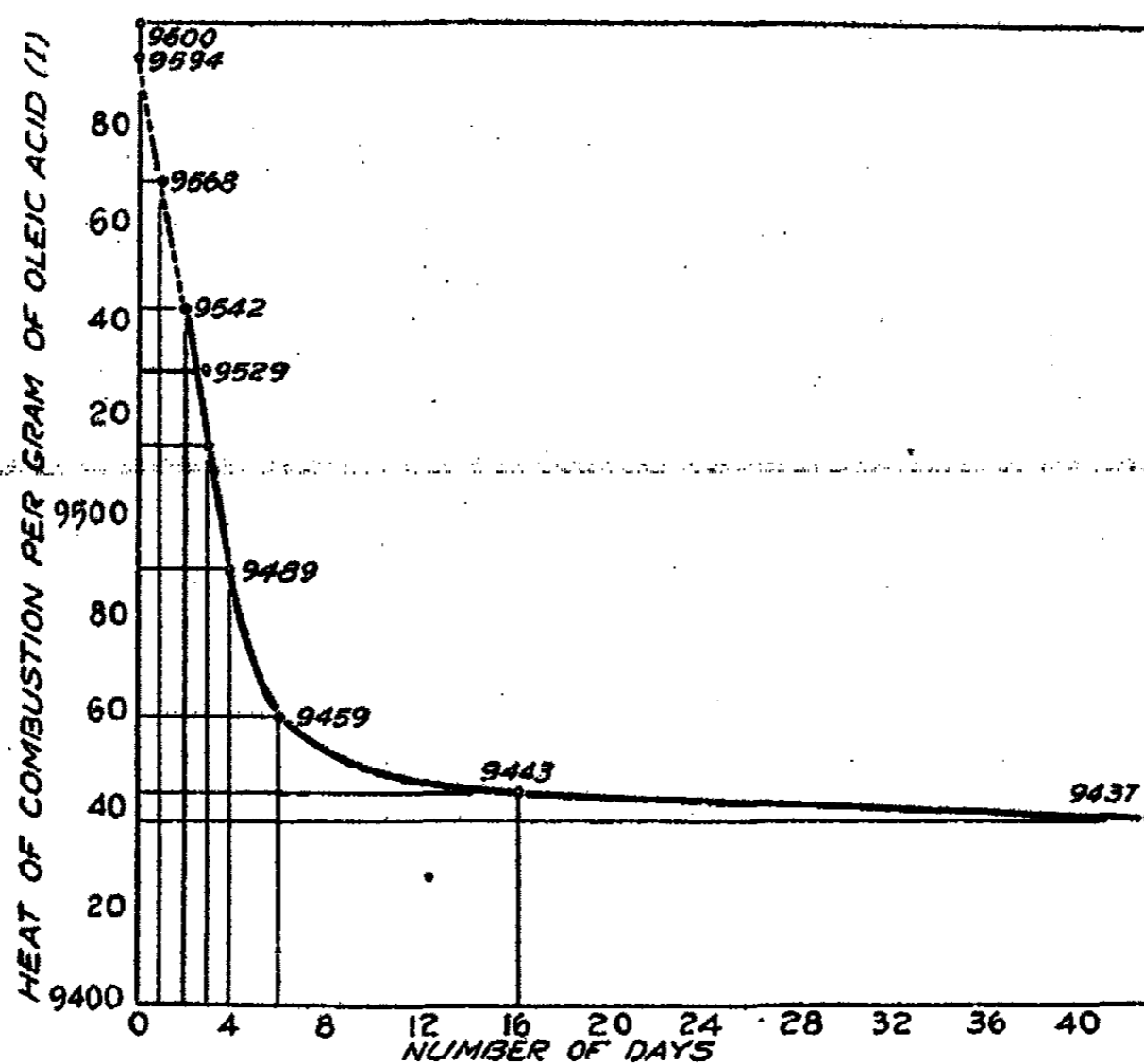

FIG. 1

I indicate that oleic acid undergoes a change which is so rapid during the first days and especially during the first hours following redistillation that its heat of combustion must certainly alter by several times the magnitude of the experimental error (cf. Exp. 10 and 11) during the time taken in preparing for a combustion. This indicates a remarkable instability similar to that observed with the *cis*-compounds of the lower homologues, e.g. *iso*-crotonic and angelic acids, and even more markedly so with maleic acid. It is remarkable that the high precision measurements of bomb calorimetry have revealed changes in oleic acid which would appear from the measurements of the iodine-value to be a perfectly stable substance.

The change in the heat of combustion with time is shown graphically by the curve reproduced in Fig. 1. This curve may be called the degradation curve of oleic acid, the word being used in its thermodynamic sense. The first two points on the curve are extrapolated from the mean of the daily change observed in the 1st., 3rd. and 4th. days, namely 26 calories. The

TABLE I  
Heat of Combustion per gram of Oleic Acid after redistillation under the high vacuum of a Cenco pump

No. of Expt.	Weight of subst. in grs (in air)	Observed temperature of calorimeter		Corrections in thousandths for stem stirring	Corr. Rise in C.	Corr. in cal. for HNO <sub>3</sub> cotton	Heat of combus. per gram	Difference between successive values	Interval of time between distill. and combustion
		Initial	Final						
(A) Acid distilled on 1-6-1926									
1	1.1849	1.021	4.027	0.1	3.0229	4	9542	2X26.5	2 days
2	1.1948	1.000	4.034	0.3	3.0443	4.2	9528(?)		"
3	1.1846	1.011	4.001	0.7	3.0053	4.6	9489	2X15	3 "
4	1.1865	1.006	3.995	0.6	3.0006	4.6	9459		4 "
5	1.2022	0.984	4.0005	0.4	3.0351	4.8	9440	10X1.5	6 "
							(mean = 9443)		16 "
6	1.2009	1.018	4.033	0.9	3.0341	4.8	9446	27X0.22	43 "
7	1.2016	1.010	4.028	2.9	3.0331	3.95	9437		
(B) Same Acid before redistillation (two years old).									
8	1.2032	1.0135	4.0235	0.1	3.0309	5.0	9419		2 years
9	1.2050	1.0185	4.0325	0.4	3.0333	4.5	9412		id
(C) Same Acid redistilled on 13-7-1926									
10	1.1827	0.984	3.9695	3.1	2.9959	0.75	9473	2X7.5	2 hours
11	1.1837	0.988	3.973	3.2	2.9937	2.4	9458	5X0.4	4 "
12	1.18445	1.023	4.010	3.2	2.9956	2.8	9456	13X0.5	9 "
13	1.1844	1.002	3.978	3.2	2.9923	3.65	9449		22 "
14	1.18415	0.990	3.964	3.3	2.9914	2.7	9446		24 "

minimum total variation for first day = 26 calories

TABLE II  
Heat of Combustion of Elaidic Acid

No. of Exp.	Weight of subst. in grs. in air	Observed temp. of calorimeter		Corrections in thousandths for stem stirr.	Corrected Rise in C.	Corrs. in cal. for HNO <sub>3</sub> cotton	Heat of combust. per gram.	Interval of time between distill. and combustion
		Initial	Final					
15	1.2089	1.028	4.043	0.6	24	3.0199	9343	1 day
16	1.2069	1.0025	4.0090	1.1	19.7	3.0156	9344	2 days
17	1.2067	1.0070	4.0095	0.4	18.2	3.0139	9343	3 days
18	1.2075	1.0360	3.0320	0.3	14.2	3.0115	9341	4 days
					mean = 9343 cal <sub>20</sub>			

TABLE III  
Heat of Combustion of Methyl Oleate

19	1.17825	1.0045	4.0065	0.6	7	3.0244	9594	2 hours
20	1.17975	0.9875	3.9990	0.9	11.5	3.0291	9599	4 hours
21	1.27895	0.993	4.0010	1.1	10.0	3.0269	9597	2 days
22	1.1807	0.996	4.0005	0.3	11.5	3.0227	9570	2 years id
23	1.1805	0.993	3.9985	0.6	13.2	3.0217	9569	
						mean		
						8.7	27.6	
						7.6	25.8	
						8.6	26.6	
						7.6	26.2	
						7.0	26.8	
						mean		

TABLE IV  
Heat of Combustion of Methyl Elaidate

24	1.17905	0.9945	4.0035	1.6	9.5	3.0279	9598	2 hours
25	1.18015	0.9990	4.0035	1.8	4.7	3.0280	9595	1 day
26	1.1806	0.9935	3.9970	0.6	11.7	3.0212	9596	2 years id
27	1.17995	0.9945	3.9985	0.2	13.2	3.0206	9568	
						mean		
						9.9	26.6	
						5.2	27.8	
						6.3	26.4	
						6.3	27.4	
						mean		
						9571	9569	



shape of the curve indicating that a state of equilibrium is practically reached after 2 to 3 months, possibly an equilibrium between the monomolecular oleic acid a stable or metastable polymer.

The results set forth in Table II indicate that elaidic acid is perfectly stable. The esters on the other hand give results which may indicate some degradation in energy content during an interval of two years. It must not be forgotten, however, that there might have been a variation in the palmitic and linoleic ester content of the oleic ester after redistillation.

#### Summary

1. The heats of combustion of elaidic and oleic acid and their methyl esters have been determined.
2. In the case of the two acids, the much higher value found for oleic acid confirms the view already put forward from the study of other properties, namely that oleic acid should be considered as the *cis*-form and elaidic acid as the *trans*-form of the same substance.
3. In the case of the esters, however, the difference if any, existing between the heats of combustion of the two isomers was so small that it was within the limits of experimental error. No definite conclusion can therefore be drawn from the study of the esters.
4. Whilst elaidic acid and the methyl esters of this acid and of oleic acid were found to be apparently quite stable, this is not the case with oleic acid, which changes in energy content with time. The velocity of the change, which is very rapid at first, decreases with time until a state of equilibrium is finally reached after a long interval.

*Inorganic Department,  
The University of Liverpool,  
January 20, 1930.*

#### References

- <sup>1</sup> Baruch: *Ber.*, 173 (1904).
- <sup>2</sup> N. and A. Saytzeff: *J. prakt. Chem.*, 422, (1905).
- <sup>3</sup> Harries: *Ann.*, 358 (1910).
- <sup>4</sup> R. Robinson and Mrs. G. M. Robinson: *J. Chem. Soc.*, 127, 175 (1925); 1926, 2204.
- <sup>5</sup> Lapworth: *J. Chem. Soc.*, 127, 1628 1987 (1925).
- <sup>6</sup> Armstrong and Allan: *J. Soc. Chem. Ind.*, 43, 207T (1924).
- <sup>7</sup> T. P. Hilditch: *J. Chem. Soc.*, 1926, 1828.
- <sup>8</sup> Muller and Shearer: *J. Chem. Soc.*, 124, 3163 (1923).
- <sup>9</sup> Stohmann: *J. prakt. Chem.*, 31, 299 (1885); 49, 109 (1893).
- <sup>10</sup> Stohmann: *Ber.*, 28, 134 (1895); *Z. physik. Chem.*, 10, 416 (1892).
- <sup>11</sup> Roth and Stoermer: *Ber.*, 46, 260 (1913).
- <sup>12</sup> Verkade and Coops: *Rec. Trav. chim.*, 47, 606 (1928).
- <sup>13</sup> Bertram: *Rec. Trav. chim.*, 46, 397 (1927).

## CATAPHORETIC MEASUREMENTS AND THE THEORY OF THE CRITICAL POTENTIAL

BY DAVID R. BRIGGS\*

In the year 1900, Hardy<sup>1</sup>, from some studies on a hydrophobic sol, postulated that the stabilizing influence thereof was the electrical charge carried by the particle and that when this charge was reduced to a zero value by added electrolytes, the sol would be precipitated.

Powis<sup>2</sup>, in his experiments on the effects of electrolytes on the cataphoretic velocity of oil droplets, reached the conclusion that such a suspensoid remained stable until the cataphoretic velocity, and therefore the  $\zeta$ -potential across the interface, water-oil, was reduced to a very definite value greater than zero, at and below which coagulation took place. He called this the "critical potential" of the sol. Every electrolyte that he used, irrespective of the valences of its ions, reduced the cataphoretic velocity to this value before it was able to bring about coagulation. He was able to repeat these results with an  $As_2S_3$  sol<sup>3</sup> with the exception that salts of monovalent cations, such as KCl, were found to bring about coagulation while the sol particles still retained a migration velocity nearly equal to (in cases even greater than) that of the original sol to which no electrolyte had been added after the process of preparation. This observation has since been found to be the general condition<sup>4</sup>, that is, the large majority of negatively charged sols show this exceptional behaviour with salts of monovalent cations.

The object of the present research was to determine whether this exceptional action is a general property of monovalent cation salts or whether it is a secondary effect which has its source in the relatively high concentrations of salt required to precipitate the sol when such salts as KCl are used to bring about coagulation.

There is a group of monovalent cations which is very highly adsorbed at all negative interfaces and low concentrations of these electrolytes bring about precipitation of the sols. To this group belong many basic dyes, as new fuchsin, alkaloids, as strychnine and morphine, and many other basic organic substances, as aniline and its derivatives. These, when in combination with equivalent quantities of acid, form monovalent cation salts, which cause precipitation in low concentrations and should, if the monovalent ion has no peculiar property causing it to be an exception to the rule postulated by Powis, reduce the cataphoretic migration velocity,  $u$ , and therefore the

\* National Research Council Fellow in the Biological Sciences, 1927-1929; present address, Otho S. A. Sprague Memorial Institute, Chicago, Illinois.

<sup>1</sup> Hardy: Proc. Roy. Soc., 66, 110 (1900).

<sup>2</sup> Powis: Z. physik. Chem., 89, 186 (1915).

<sup>3</sup> Powis: J. Chem. Soc., 109, 734 (1916).

<sup>4</sup> Freundlich and Zeh: Z. physik. Chem., 114, 65 (1925); Kruyt and van d. Willigen: Z. physik. Chem., 130, 170 (1927); Mukherjee and Raichoudhuri: Nature, 122, 960 (1928).

charge,  $e$ , to the same value as that which is obtained with polyvalent cation salts of the inorganic type at those concentrations at which they bring about precipitation of the colloid.

Accordingly, cataphoretic velocity measurements have been made upon samples of several sols to which have been added varying amounts of these various types of electrolytes. Generally, the cataphoretic velocity was found at five or six concentrations of each electrolyte for each sol, these concentrations being equally spaced between zero concentration and that corresponding to about 90 per cent of the concentration found to be the coagulation value.

#### Cataphoretic Velocity

The cataphoretic velocity measurements observed in this research were those obtained with the modified Burton U-tube apparatus lately developed by Kruyt and van der Willigen<sup>5</sup>, in which two sets of electrodes are used, the potential across the inner two, (and therefore across the chamber containing the sol) being kept constant throughout the experiment by the simple method of varying the potential across the outer two electrodes as the resistance of the liquid contained in the apparatus varies due to electrolysis in the neighborhood of these electrodes. The inner electrodes are used only as a means to ascertain and keep constant the potential difference between two points in the U-tube and no current was allowed to flow through them.

The liquid used above the sol was in all cases the ultrafiltrate of the sol with or without the electrolyte, as the case might be. Ultrafiltration was accomplished in a manner adapted from the method of Bechhold and Gutlohn<sup>6</sup> and adequately described in the paper by Kruyt and van der Willigen. A thin collodion membrane supported by a porous porcelain cup acted as the filter and allowed a fairly rapid filtration to be accomplished when subjected to a suction equivalent to 2-4 cm. of mercury pressure in the suction flask. The sol containing the required amount of salt for the particular experiment being carried out, was ultrafiltered, a portion being retained to be used in the cataphoretic measurement. The ultrafilter was washed by passing about 200 cc. of the sol through it before collecting the ultrafiltrate of the remainder.

Van der Willigen<sup>5</sup> found that the rate of migration of the rising interface between the sol and its ultrafiltrate was proportional to the fall of potential per unit length in the ultrafiltrate, while the falling interface advanced at a rate proportional to the fall in potential per unit length in the sol, that is, each interface for a given potential drop between the inner electrodes advanced with a rate which was directly proportional to the specific resistance of the liquid into which it advanced. He gave as the average velocity,  $u$ , of migration of the sol,

$$u = \frac{w_1 h_1 + w_2 h_2}{Z E} \quad (a)$$

where  $w_1$  and  $w_2$  are the observed distances moved by the rising and falling

<sup>5</sup> Kruyt and van der Willigen: *Kolloid-Z.*, 44, 22 (1928).

<sup>6</sup> Bechhold and Gutlohn: *Z. angew. Chem.*, 37, 494 (1924).

interfaces respectively;  $h_1$  and  $h_2$ , the average lengths of ultrafiltrate and of sol, respectively, lying between the inner electrodes across which is maintained the constant potential drop,  $E$ ; and  $Z$  is the time during which the migration was allowed to continue.

This relation seems to hold very well with a sol in which no settling is observable after it has been run into the U-tube. Such is the case with the  $As_2S_3$  sol but not with the other sols used in the present experiments. What this settling is due to is not known, but it seems to be a contraction of the sol which continues with an ever diminishing rate for some time after the sol is run, however slowly, into the U-tube under the clear liquid (ultrafiltrate). If the sol is placed into the U-tube with no other liquid above it, no settling occurs. The effect seems most noticeable when the number of particles per unit volume is least. As mentioned before, the  $As_2S_3$  sol exhibits settling the least or not to a measurable extent; the gold, silver and selenium sols show it to respectively greater degrees. With these sols, it is obvious that the velocity,  $u$ , cannot be calculated from the equation (a). However, all these sols which show this effect also show very small differences between the specific conductivity of the sol and its ultrafiltrate. In such a case there would be no very great difference in the drop of potential through unit length of sol and of ultrafiltrate, so that, were the settling effect not present, each boundary would migrate at the same velocity. The settling effect is the same in both sides of the U-tube so that  $u$  can be calculated simply from the average rate of motion of the two boundaries divided by the potential drop per unit length, *i.e.*,

$$u = \frac{1/2(w_1 + w_2)H}{Z E} \quad (b)$$

where  $H$  denotes the effective length of the U-tube between the two inner electrodes. Values of  $u$  for the  $As_2S_3$  sol were calculated from equation (a), but for the Au, Ag and Se sols,  $u$  was calculated according to equation (b).

Determinations of the migration velocity were made in duplicate and three separate U-tubes were used simultaneously in order to expedite the experiment. The effective lengths of these cells were found by filling them with a conducting solution and measuring the resistance values between various points in the U-tube, from which the electrical length could be calculated. These values for  $H$ , were found to be for Cell No. 1—21.82 cm., Cell No. 2—26.67 cm. and Cell No. 3—26.92 cm., these lengths being those existing between the two zero marks on the tubes which were the positions at which the inner electrodes were always placed.

#### Coagulation Values

The coagulation values used in these experiments were those observed when 2 cc. of electrolyte solution was added uniformly from a pipette to 10 cc. of the sol contained in a precipitation tube, the resulting solution then uniformly mixed by rotational shaking before setting aside to be again shaken 24 hours later and finally observed  $\frac{1}{2}$  hour later. The coagulation value was

taken as that concentration of electrolyte which, through the above procedure, just gave a perfectly clear liquid above the coagulum. With all sols and most salts (barium chloride being a partial exception) the value thus obtained was permanent up to five or six days, the greatest length of time any were allowed to stand for observation. With the gold and silver sols this coagulation value does not coincide with that of the first marked change in color (e.g., in the gold sol—the color change from red to blue) but with a considerably higher concentration of electrolyte. The selenium sols are very slow to settle after disturbance so that the coagulation values observed with them were those after 24 hours without disturbance. The other sols, particularly the gold and silver sols, settled very quickly after the shaking after 24 hours standing and gave beautifully sharp values for the coagulation value.

In preparing the sol for the cataphoretic measurements the stock sol was always increased in volume by 20 per cent, this added liquid being pure water in cases where the measurements on the pure sol were to be carried out, or an electrolyte solution of sufficient concentration to give the resulting sol solution the required concentration for the experiment. The electrolyte solution was always added to the sol in a manner as nearly as possible the same as that used when adding it to determine the coagulation value. In both types of experiment the percentage increase in volume due to added electrolyte solution was the same.

#### Preparation of Sols

The  $\text{As}_2\text{S}_3$  sol was prepared according to a much used method, by dissolving 3 grams of  $\text{As}_2\text{O}_3$  in 500 cc. distilled water at the boiling temperature in a Jena flask under a reflux condenser, this solution being then added drop by drop to 200 cc. of distilled water which had been saturated with washed  $\text{H}_2\text{S}$  gas. This gas was also bubbled through the solution as the  $\text{As}_2\text{O}_3$  solution was added, thus keeping at all times an excess of  $\text{H}_2\text{S}$  present in the liquid in which the  $\text{As}_2\text{S}_3$  was being formed. When reaction was complete the excess of  $\text{H}_2\text{S}$  was removed (until no odor could be detected) by a stream of  $\text{H}_2$  gas bubbled through the solution, the  $\text{H}_2$  being previously washed through alkaline  $\text{KMnO}_4$ ,  $\text{HgCl}_2$ ,  $\text{NaOH}$  solutions and finally through water. This sol was filtered and kept at the prepared concentration but was diluted with five parts of water to one part of sol before use, this dilution being made a few hours before the measurements were carried out. The diluted sol thus contained approximately 1.06 grams of  $\text{As}_2\text{S}_3$  per liter.

The Selenium Sol No. 1 was made<sup>8</sup> by bringing to the boiling temperature in a Jena flask 550 cc. of doubly distilled water which contained 30 cc. of a 1.2 molar solution of hydrazine hydrate, then adding quickly 25 cc. of a 0.1 molar solution of  $\text{SeO}_2$  and finally, after the sol had reached a salmon-yellow color, 5 cc. more of the same solution were added. The flask was then removed from the flame and, after the sol had cooled for 10 minutes it was

<sup>8</sup> Kruyt and van Arkel: *Kolloid-Z.*, 32, 29 (1923).

diluted with  $2\frac{1}{2}$  liters of distilled water. The sol had a rich salmon-red appearance when cool and contained 0.076 grams of Se per liter.

The Selenium Sol No. 2 was prepared as above but had nearly all of the electrolyte removed by a process of quick dialysis which it was found possible to utilize with this sol, though it cannot be used for many other sols. It was found that when the sol was subjected to ultrafiltration but was not entirely freed of liquid before the ultrafiltration was stopped, the sol particles could be again dispersed by shaking them with a new portion of doubly distilled water, the sol remaining apparently as stable as before. By repeating this process several times, nearly all the excess hydrazine could be removed, the resulting sol having characteristics somewhat different from those of Se Sol No. 1, as will be described later. The exact selenium content of this sol was not determined, but sufficient water was added to make the color about the same intensity as that of No. 1.

A silver sol was prepared in the rather unusual manner referred to by Rock and Klosky,<sup>9</sup> namely, by filtering a boiling-hot, saturated solution of  $\text{Ag}_2\text{O}$  through a washed filter paper and, after cooling the filtrate, again heating it to  $80^\circ\text{-}90^\circ\text{C.}$  and keeping it at this temperature until the sol no longer changed in color. The sol had a green color by transmitted light and was almost black by reflected light and seemed very stable although it possessed a low migration velocity. The reaction seems to have been a reduction of the  $\text{Ag}_2\text{O}$  by some dextrin-like material from the filter paper which was extracted as the hot solution passed through, and subsequently reacted fairly rapidly at the temperatures mentioned, but very slowly at room temperature. The only electrolyte present in the sol was a small concentration of  $\text{Ag}_2\text{O}$  which was present in excess of the reducing material. The low value for the migration velocity exhibited by the sol seems to indicate a protective action, possibly by the oxidized product of the material causing the reduction. A large quantity of this sol is very easily and quickly prepared.

A red gold sol was prepared by the use of  $\text{H}_2\text{O}_2$  as a reducing agent after the method of Temminck-Groll,<sup>10</sup> 330 cc. of the sol being prepared at a time and this repeated until the required volume of sol was obtained (about 11 liters). To make 330 cc. of this sol, 25 cc. of a 3 per cent solution of neutral  $\text{H}_2\text{O}_2$  was added to 250 cc. of doubly distilled water, and to this was added a drop at a time, with constant and vigorous shaking, 30 cc. of a 0.066 per cent  $\text{NaAuCl}_4$  solution, followed by 2 cc. of 0.1 N  $\text{NaOH}$ , then 20 cc. of the 0.066 per cent  $\text{NaAuCl}_4$  solution, and finally 3 cc. of 0.1 N  $\text{NaOH}$ . Each quantity thus prepared was allowed to stand, with occasional shaking, for 30 minutes before it was added to the stock solution. In the ultra-microscope this sol showed the characteristic green color of the red gold sol with a very few red particles which are characteristic of the blue gold sol. This sol contained 0.06 gram of gold per liter, and was about 0.0015 normal in alkali which was probably present as  $\text{Na}_2\text{CO}_3$  and  $\text{NaHCO}_3$ .

<sup>9</sup> Rock and Klosky: *J. Phys. Chem.*, **33**, 143 (1929).

<sup>10</sup> Temminck-Groll: *Chem. Weekblad*, **13**, 617 (1916).

Tables I, II, and III give those properties of the sols which are readily measurable. The  $As_2S_3$  sol obviously contains a much higher amount of colloid than any of the others as is clearly evidenced by the conductivity measurements on the sol and its ultrafiltrate. It would be of the highest importance to know of just what ions the double layers of each of these sols are made up, as well as to know what electrolytes are present in the intermicellar liquid of the original sols as used. It is possible to surmise in most cases the electrolytes which are present, but the constitution of the double layer must, in the last analysis, be left largely to the private opinion of the reader. All the sols are negatively charged.

TABLE I

Specific Conductivities of the Stock Sols diluted with 1/5 vol. of Distilled Water and of the Ultrafiltrates of the Same

Sol	K (for sol). $10^6$	K (for U-filtrate). $10^6$	Ratio $\frac{KuF}{Ksol}$
$As_2S_3$ (one sample)	37.50	16.20	0.451
Se No. 1 (stock sample)	110.70	108.40	0.979
Se No. 2 (one sample)	3.31	3.14	0.949
Ag (stock sample)	16.40	15.80	0.963
Au (stock sample)	188.00	185.00	0.984

TABLE II

Flocculation Values after 24 Hours for the Various Sols with the Electrolytes used. Values are given in Milligram Mols per Liter

Salt	$As_2S_3$	Se No. 1	Se No. 2	Ag	Au
KCl	60.0	29.0	16.6	—	24.0
$KNO_3$	—	—	—	0.70	—
New Fuchsin HCl	0.117	—	—	—	—
Strychnine $HNO_3$	0.098	0.120	0.018	0.045	0.41
$BaCl_2$	0.60	3.12	2.85	—	0.47
$BaNO_3$	—	—	—	0.050	—
$AlCl_3$	0.042	0.075	0.0018	—	0.0043

TABLE III

Initial Migration Velocities of Sols and Critical Migration Velocity with Di- or Trivalent Salts

Sol	$As_2S_3$	Se No. 1	Se No. 2	Ag	Au
Init. mig. vel. ( $\mu$ )	4.6	5.0	3.4	2.2	3.9
Crit. mig. vel. ( $\mu$ )	1.6	2.8	2.0	2.0	2.2

### Results

The results are given for the five sols in the graphs, and in Tables IV and V are shown the numerical results for the two sols,  $As_2S_3$  and Au. In the graphs it should be pointed out that while the perpendicular axis (cataphoretic velocity) is plotted on the same scale for all the graphs pertaining to a given sol, the horizontal axis (electrolyte concentration) differs in scale in all cases in accordance with the relative magnitude of concentrations used. The concentration of total precipitation is shown on the graphs by the arrow.

#### A.—Graphs for an Arsenic Trisulfide Sol.

Graphs showing the Variation of the Cataphoretic Velocity of Sols with the Concentration of Electrolytes.

Perpendicular axis = Cataphoretic Velocity in Microns per second per  $\frac{\text{Volt}}{\text{centimeter}}$ .

Horizontal axis = Concentration of Electrolyte in milligram mols per liter.

Concentration of Total Precipitation indicated by arrow and number.

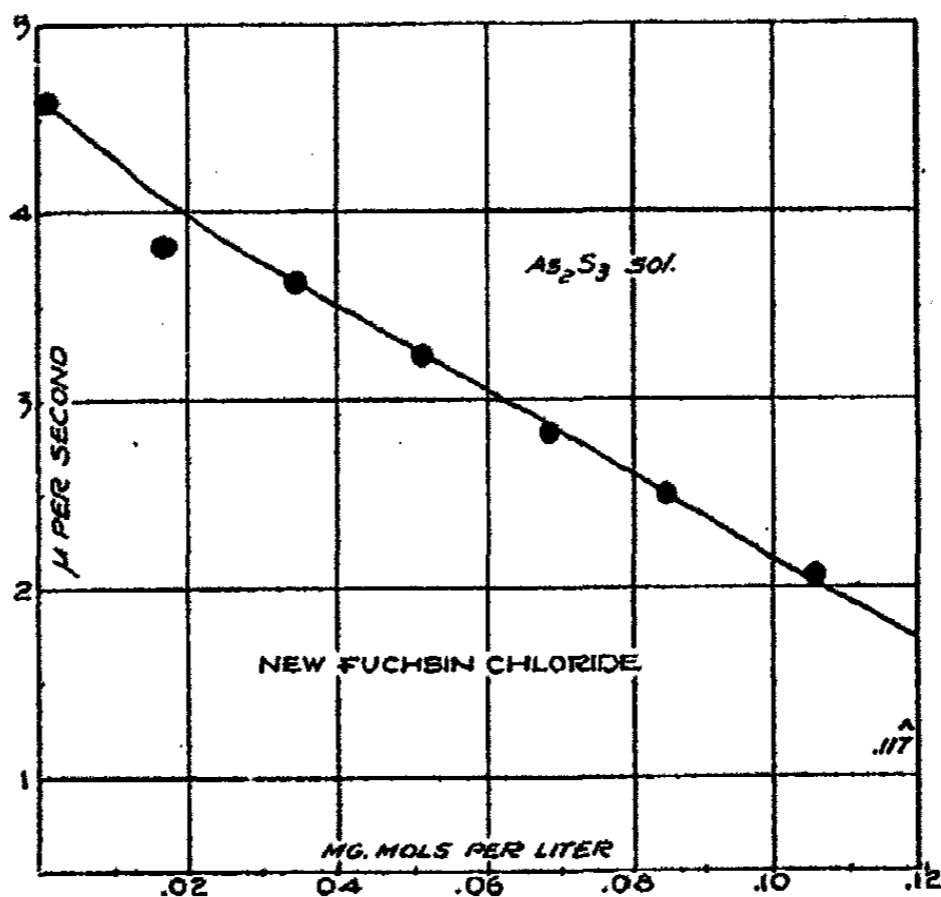



Graphs for an Arsenic Trisulfide Sol (Continued)

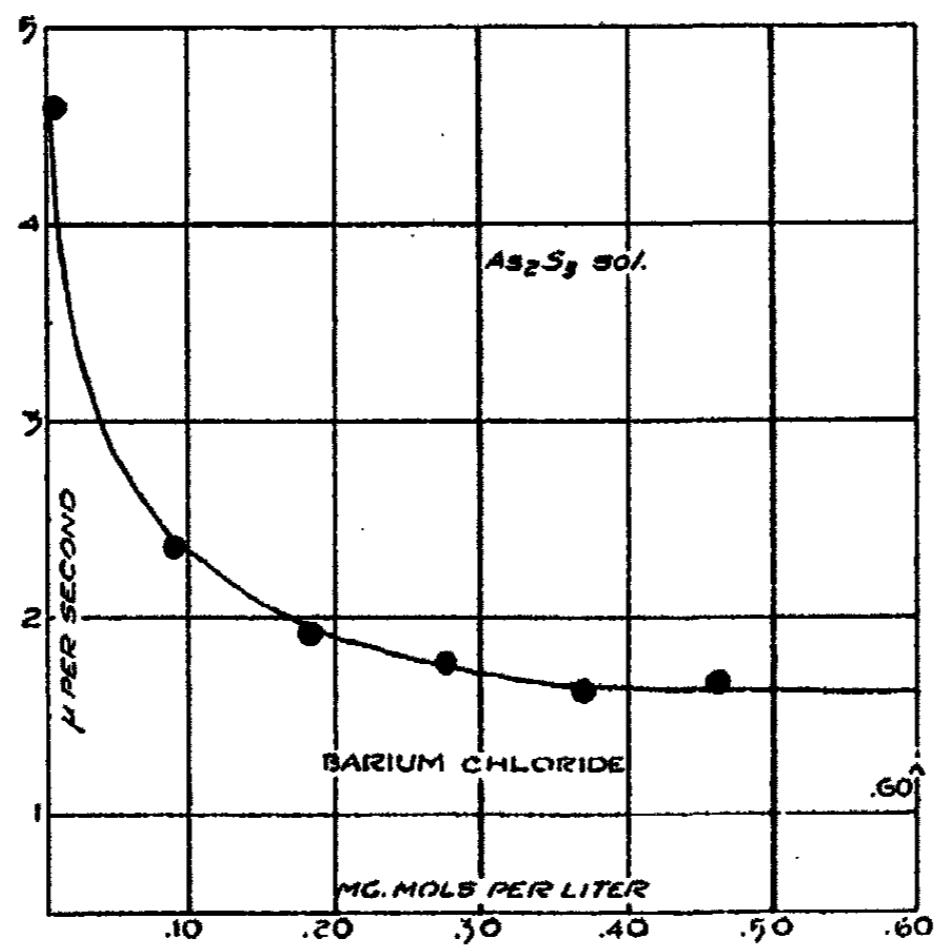
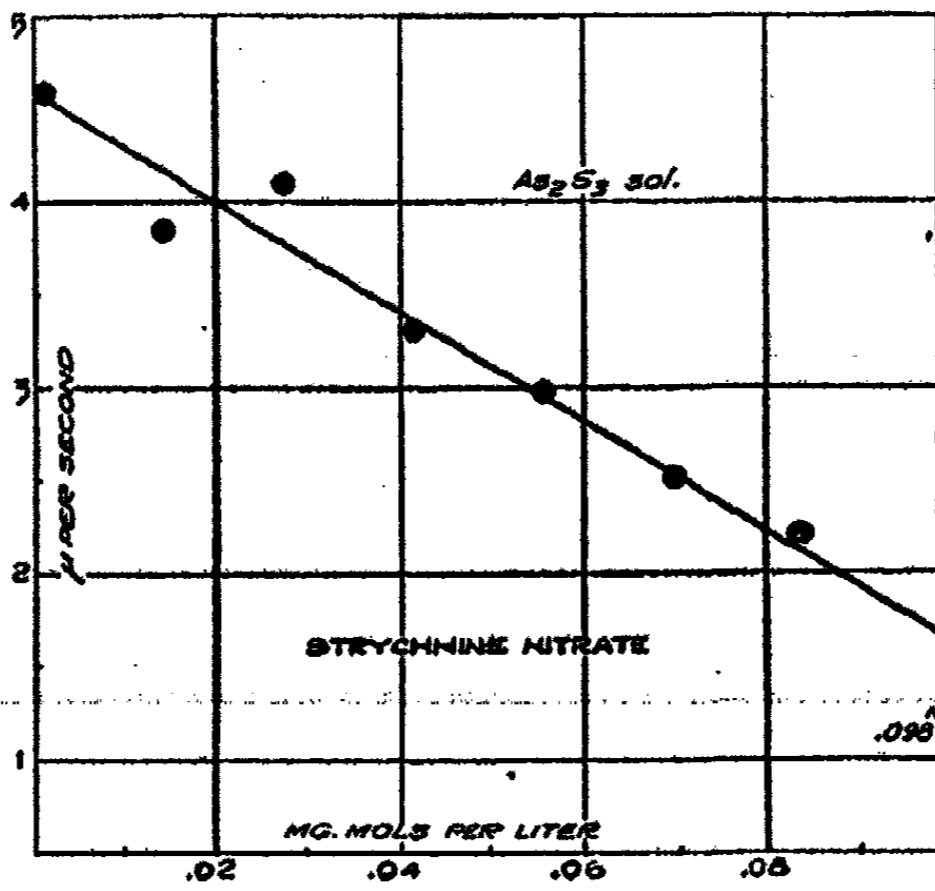

Graphs for an Arsenic Trisulfide Sol (Continued)

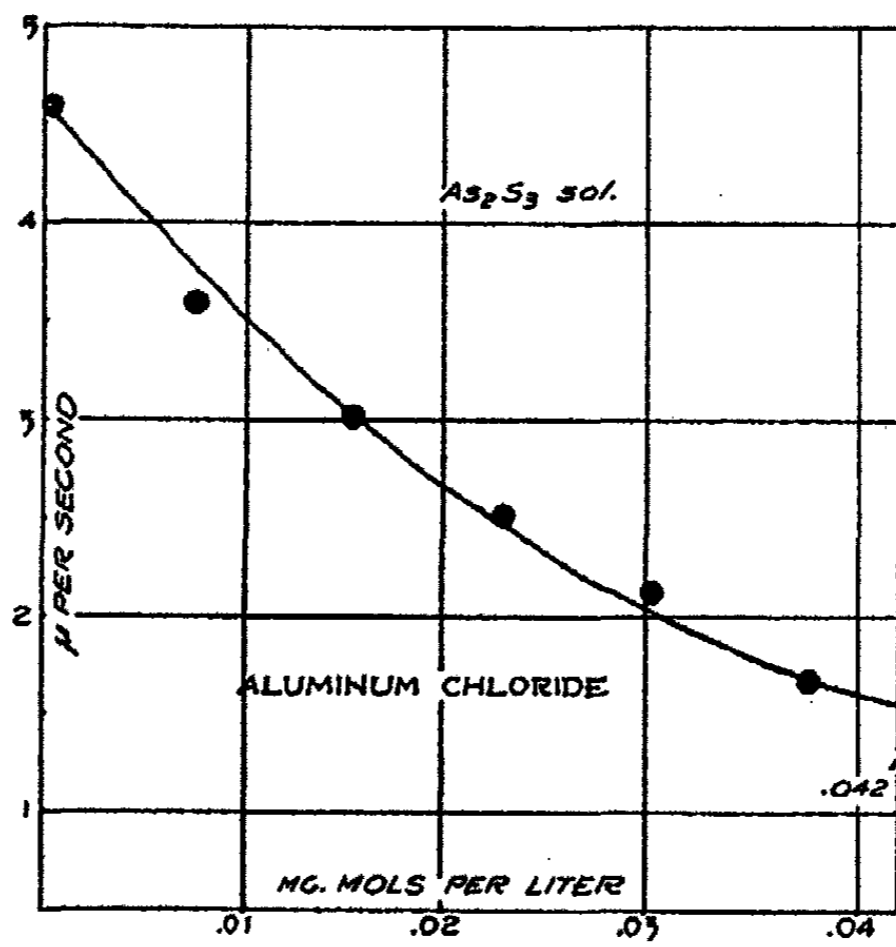
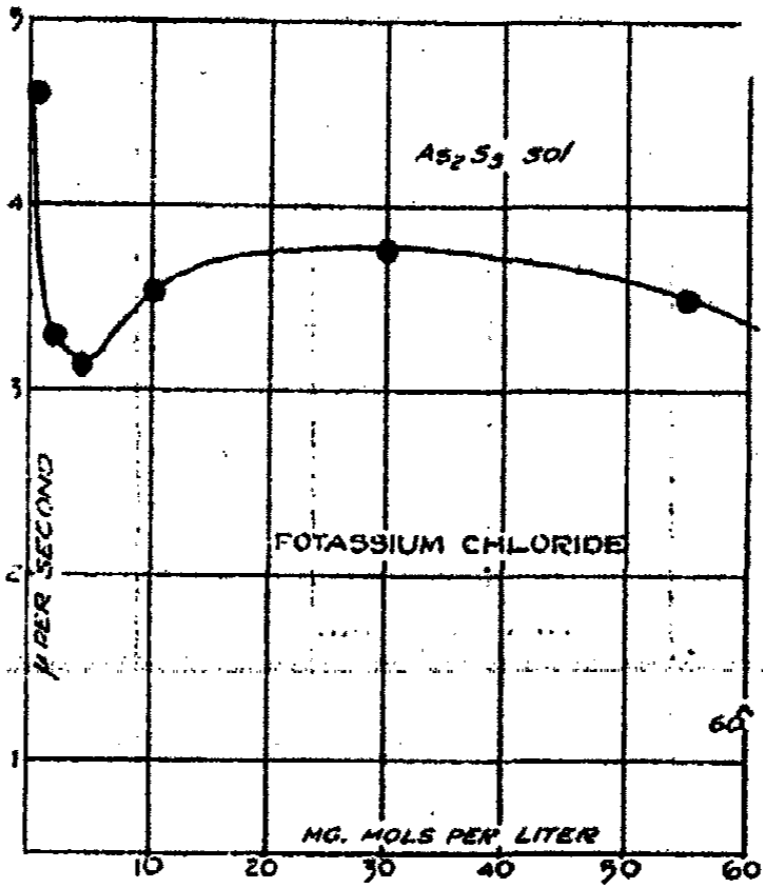

B.—Graphs for a Gold Sol

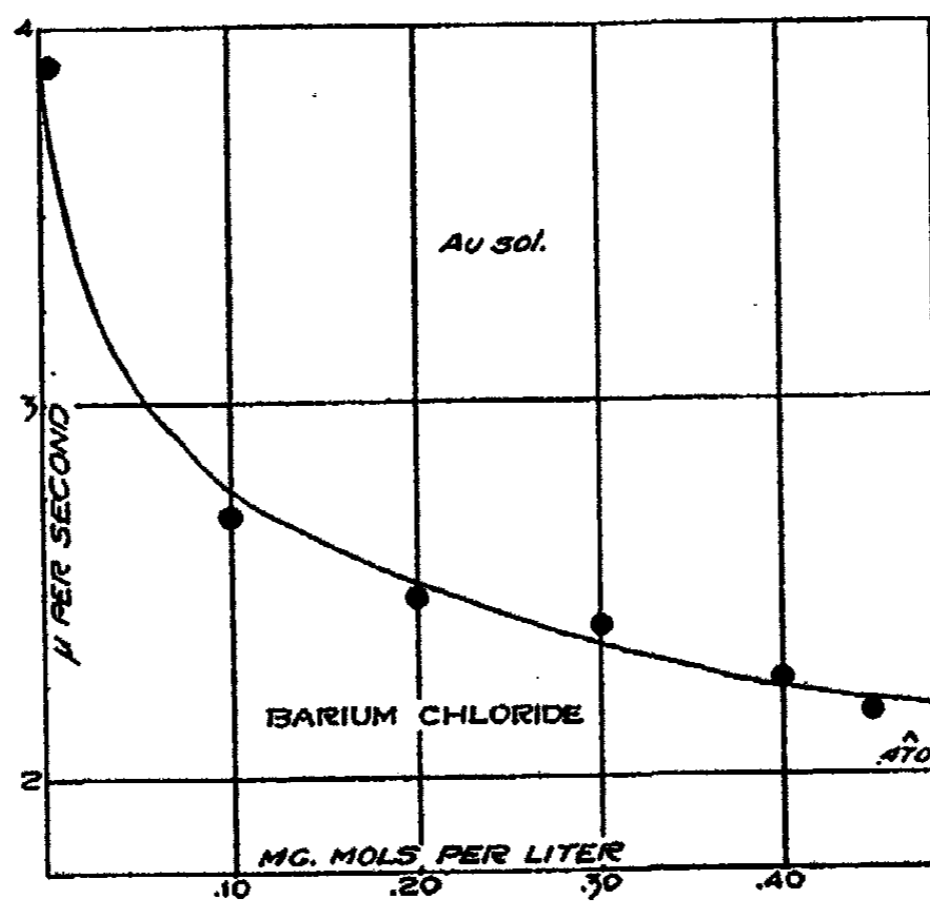
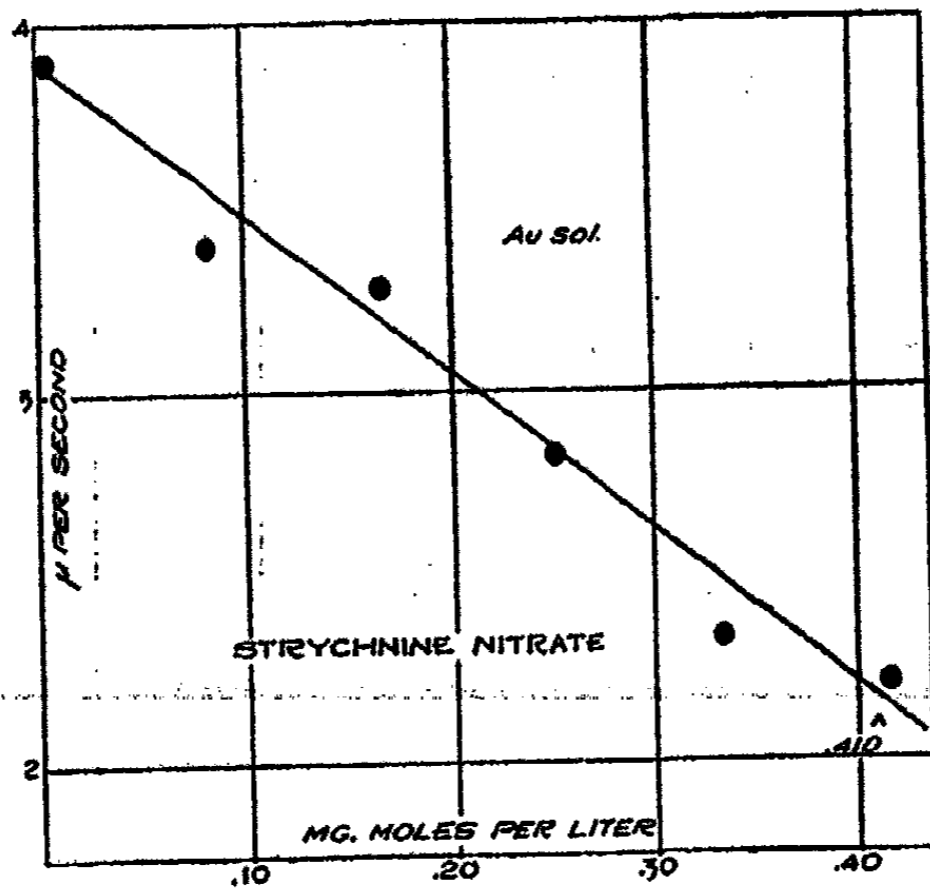

Graphs for a Gold Sol (Continued)

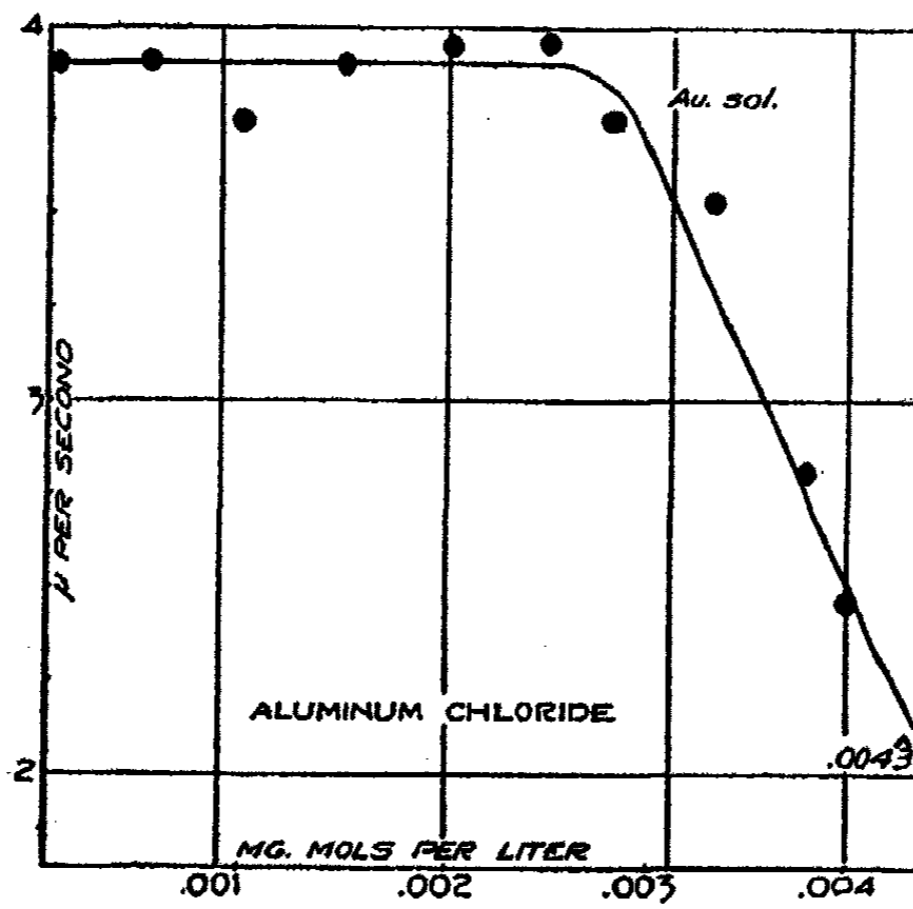
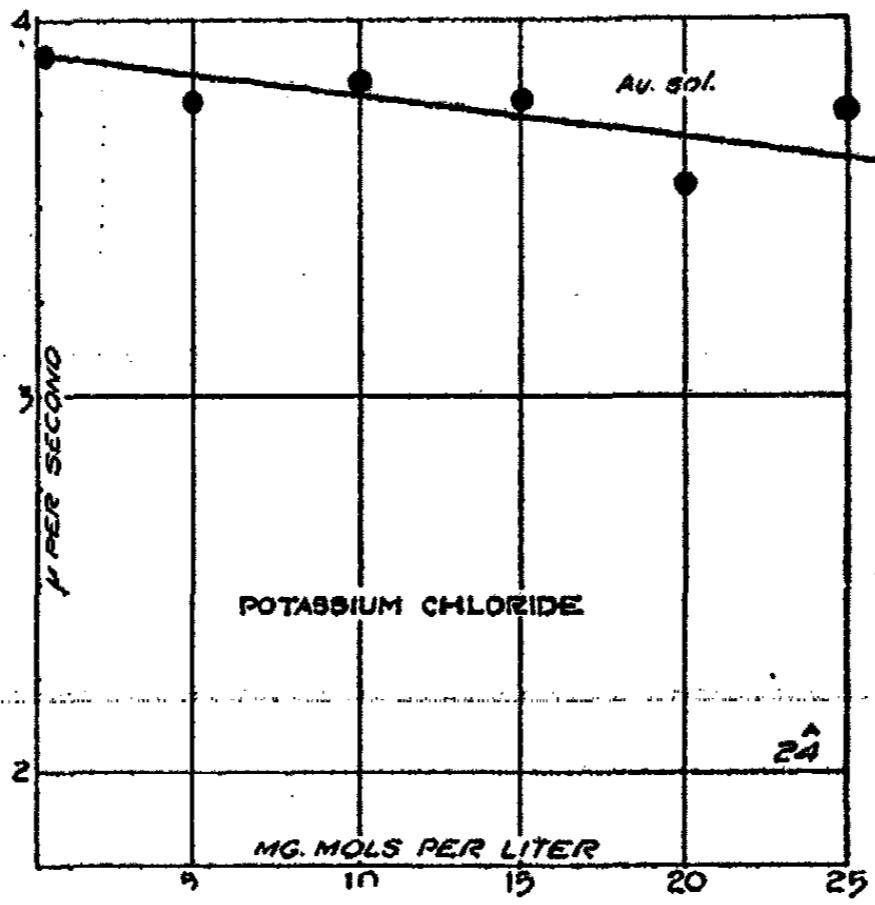

C.—Graphs for Selenium Sol No. 1

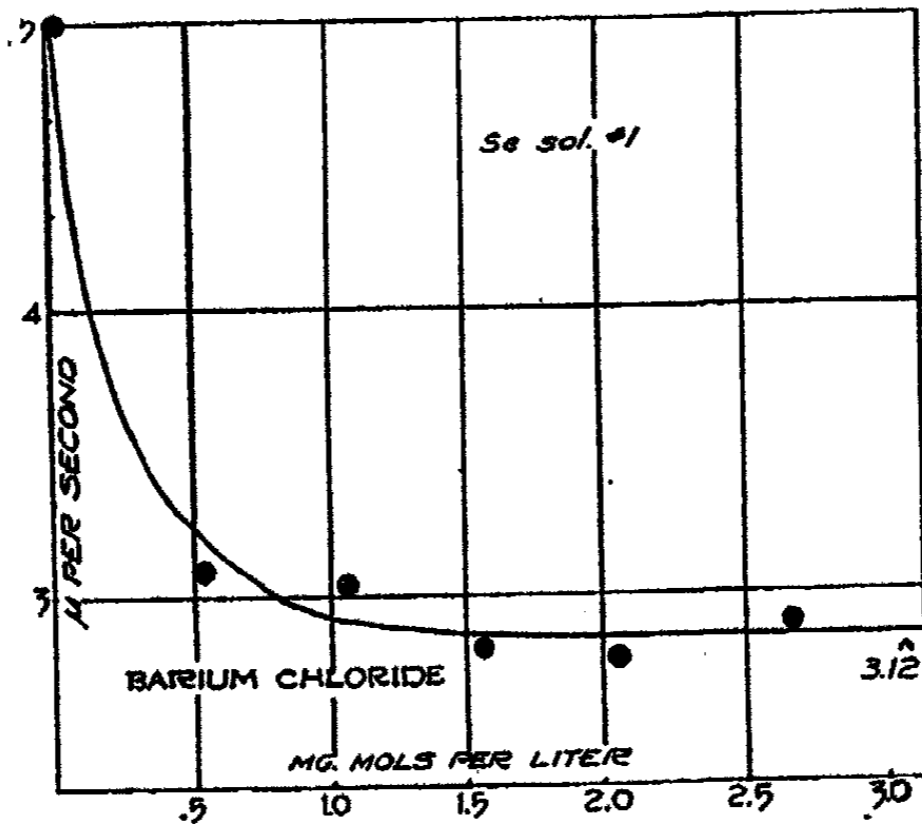
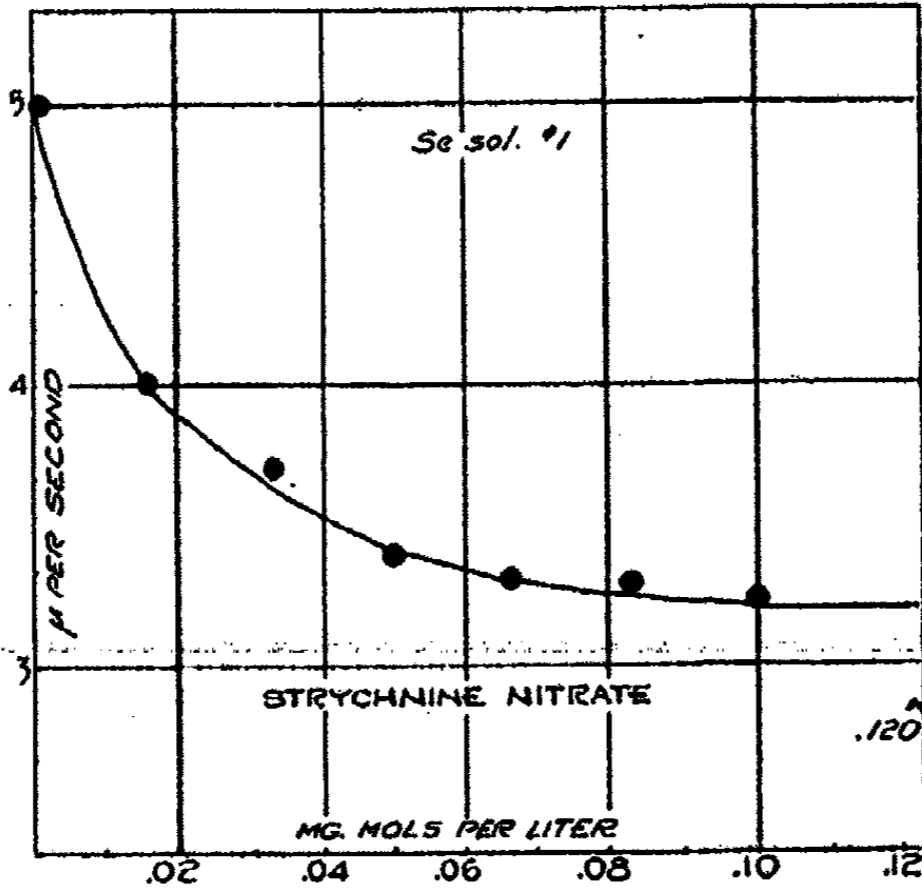

Graphs for Selenium Sol No. 1 (Continued)

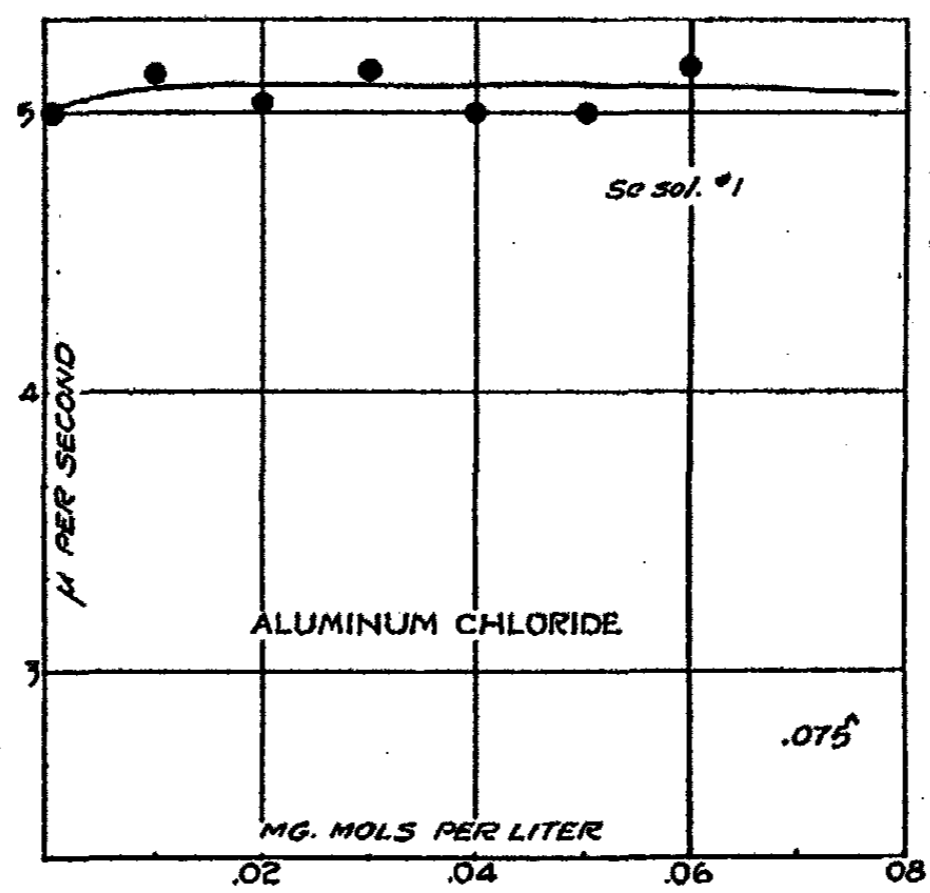
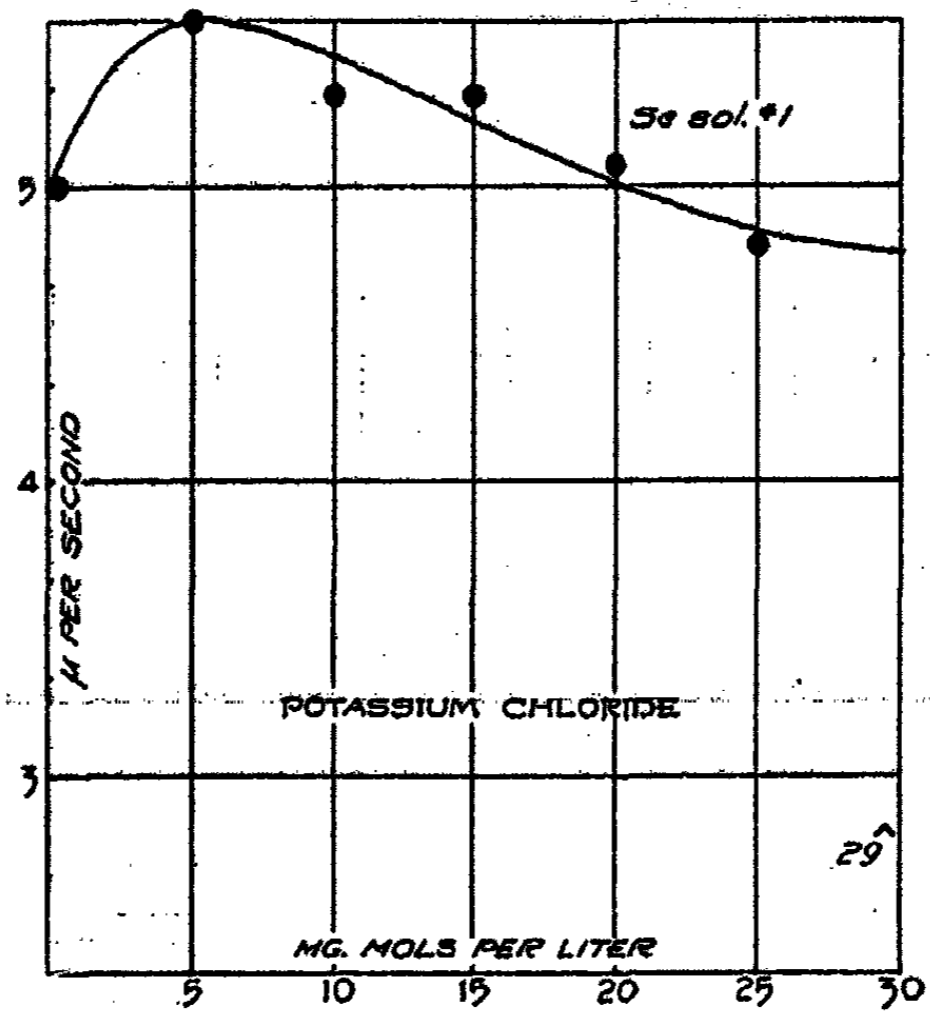

D.—Graphs for Selenium Sol No. 2

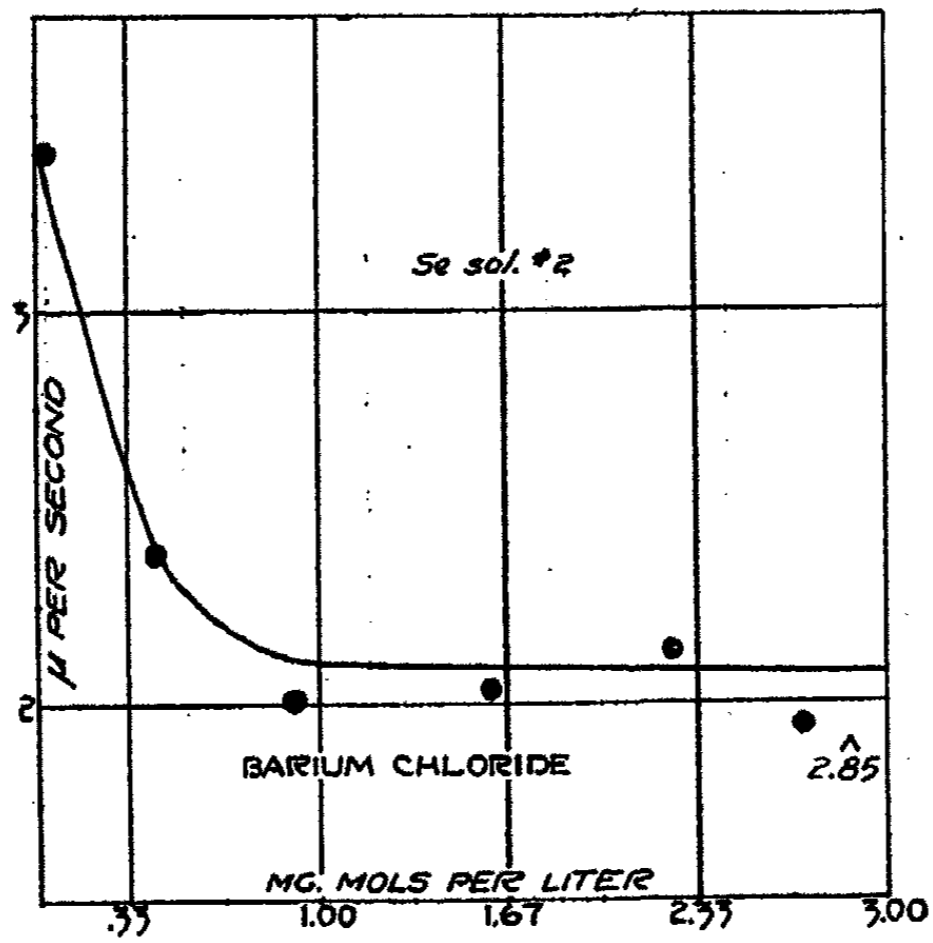
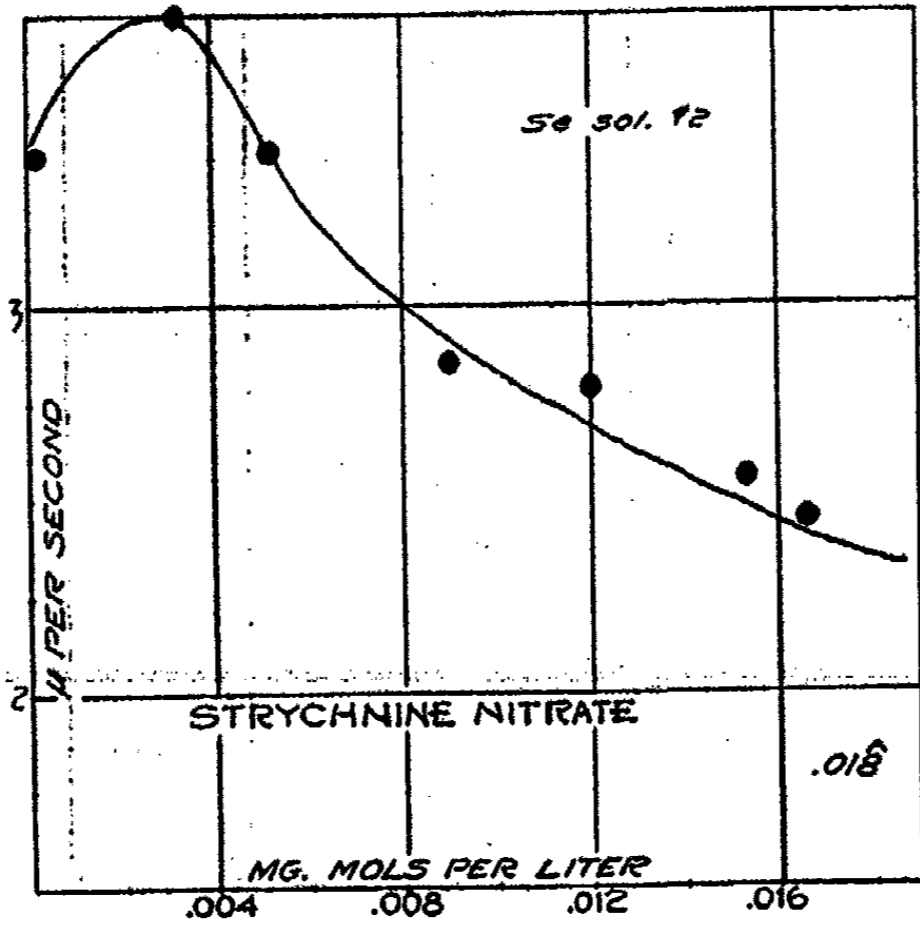

Graphs for Selenium Sol. No. 2 (Continued)

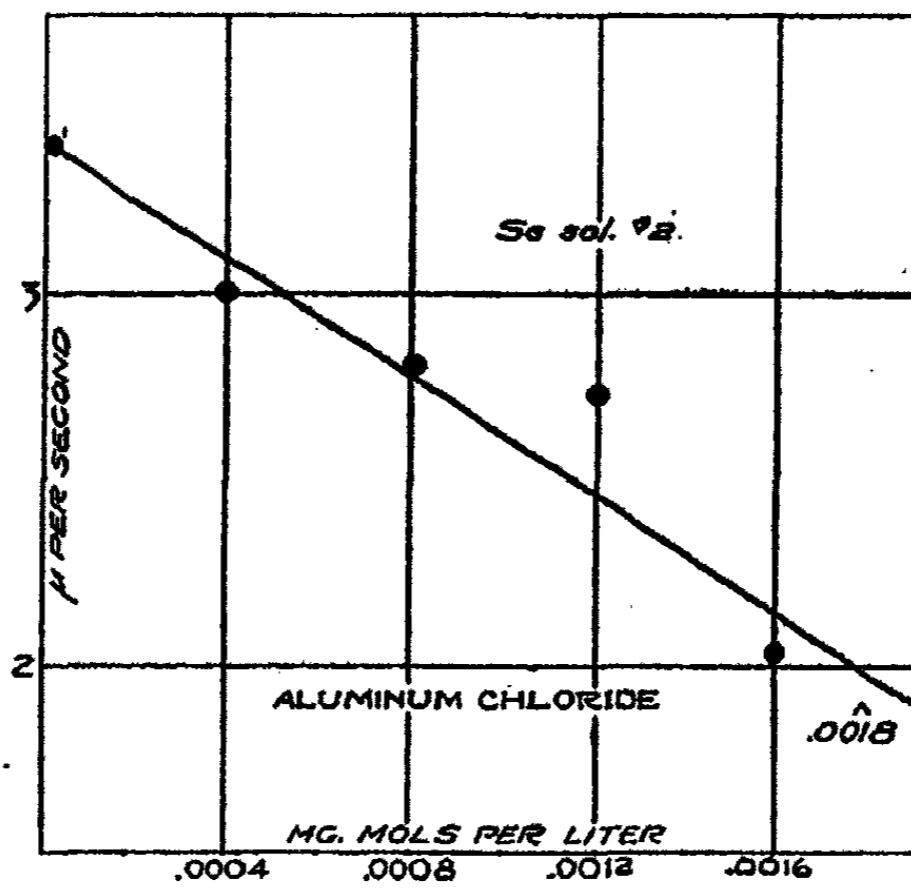
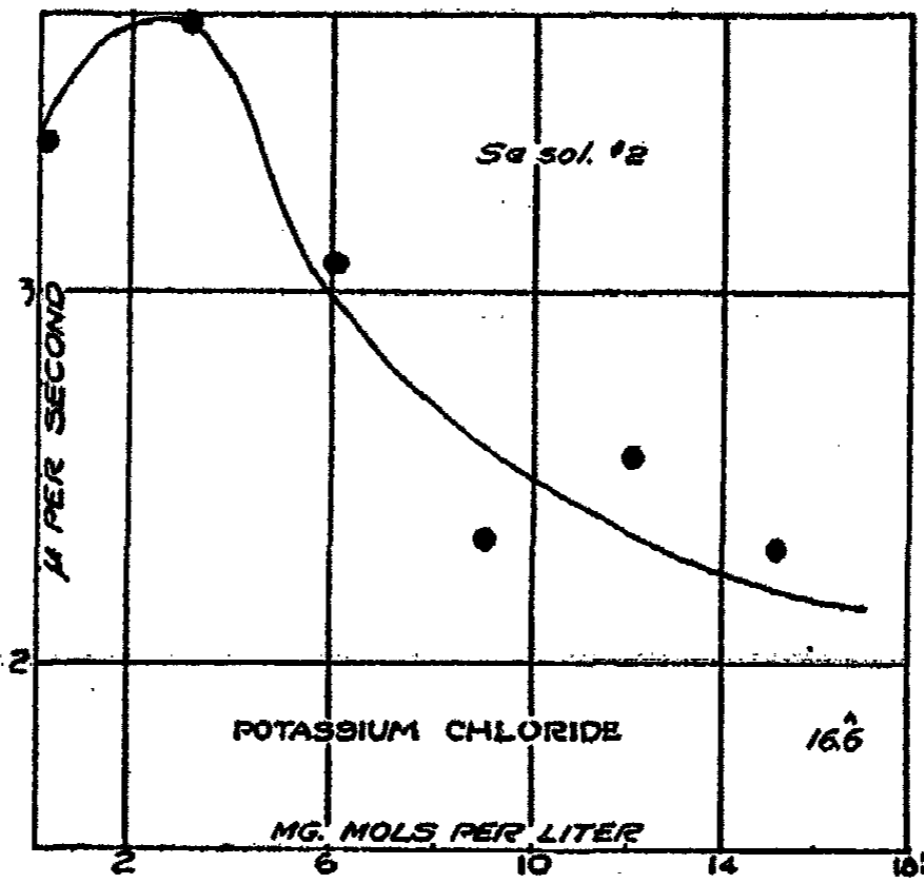



E.—Graphs for a Silver Sol

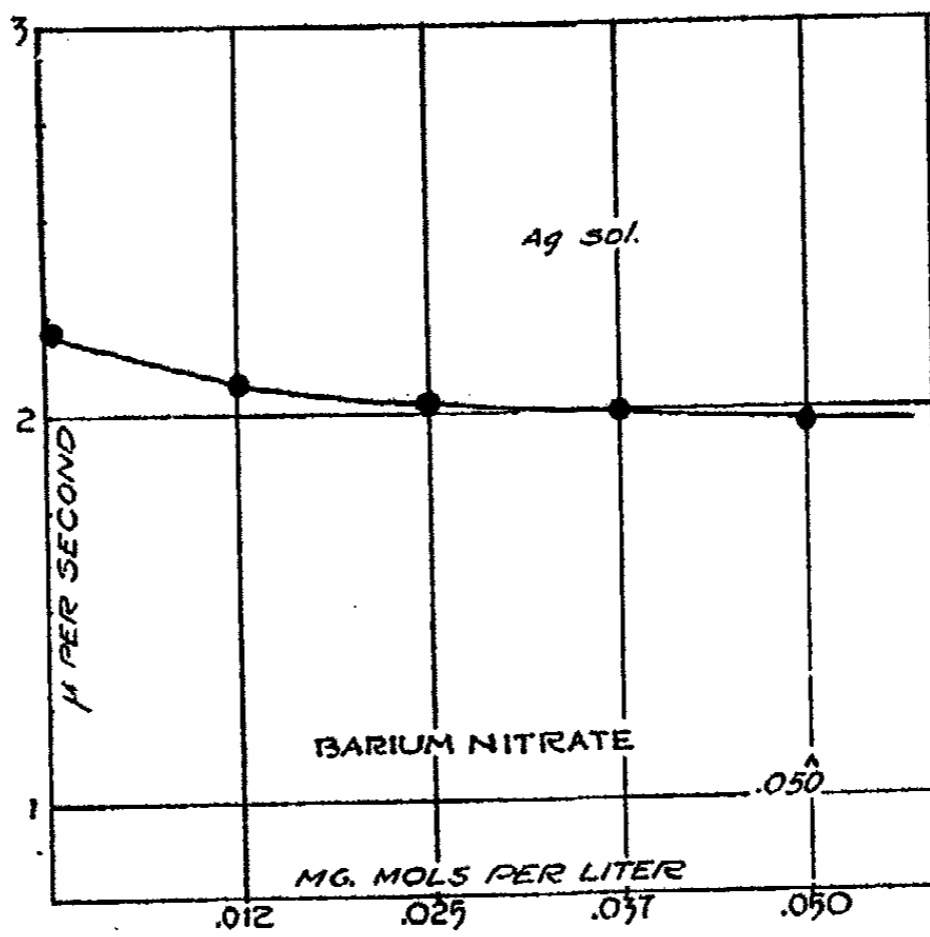
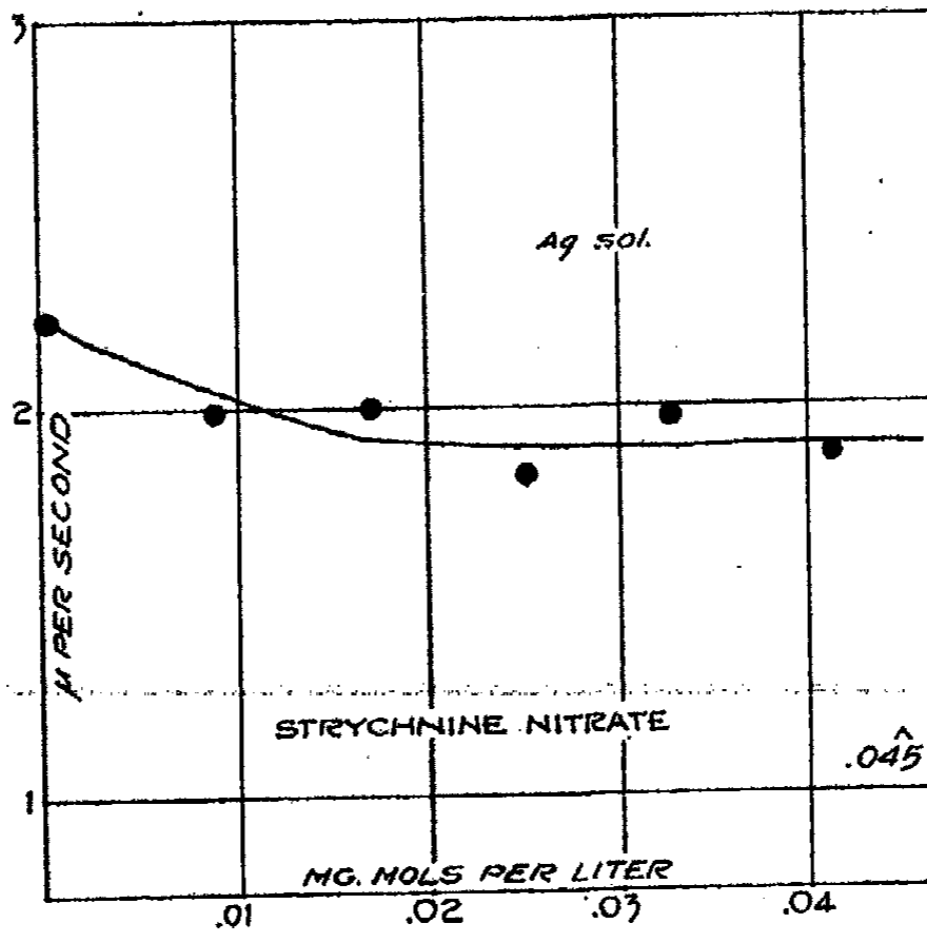

## Graphs for a Silver Sol Continued)

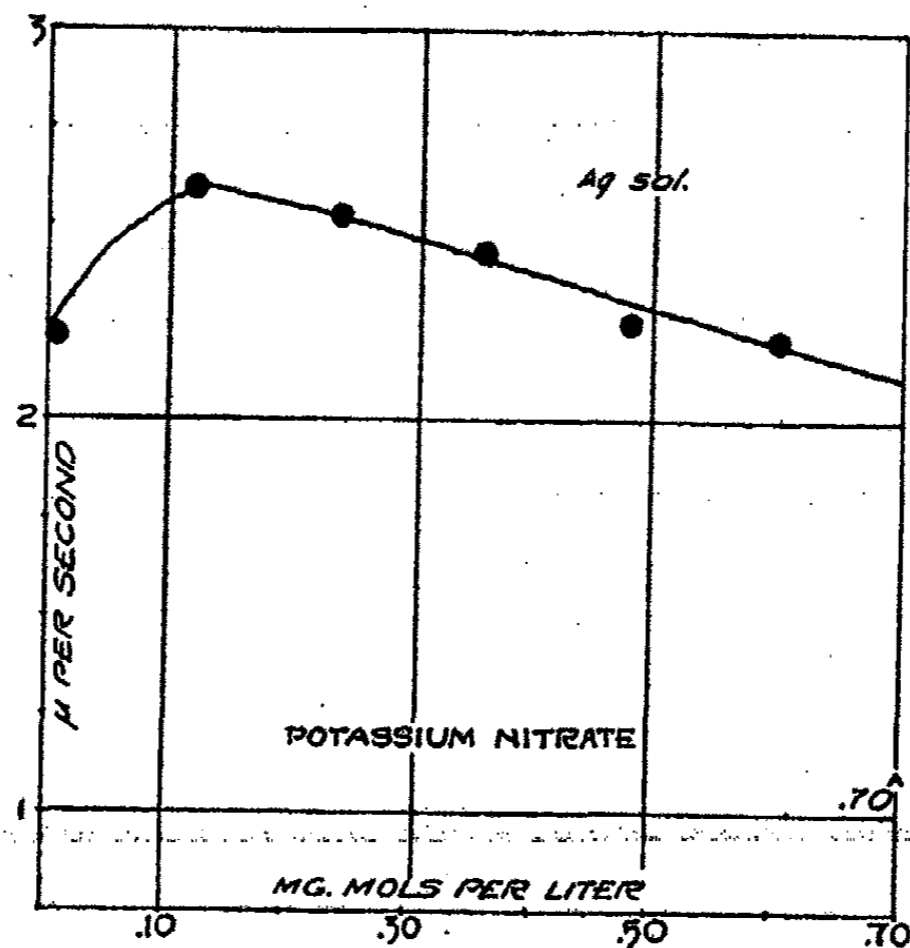

TABLE IV

Showing the Relationship between the Cataphoretic Velocity,  $u$ , of Negatively Charged Sols and the Concentration of Various Cations in the Sol. Extrapolated Values show  $u$  at the Coagulation Concentration

Arsenic Trisulfide Sol				$u = \frac{w_1 h_1 + w_2 h_2}{Z E}$				$u$ ( $\mu$ )	Cell No.
Salt Conc. Millimols per Liter	Z (min.)	E (volt)	$w_1$ (mm.)	$w_2$ (mm.)	$h_1$ (mm.)	$h_2$ (mm.)			
Sol + 1/5 vol. Water									
0.0	90	18	265	178	724	1458	4.63	1	
0.0	90	18	210	142	879	1788	4.51	2	
0.0	90	18	333	141	710	1472	4.56	1	
0.0	90	18	266	120	928	1739	4.73	2	
Sol + 1/5 vol. Water + New Fuchsin Chloride									
0.017	90	18	253	138	656	1526	3.88	1	
0.017	90	18	196	106	959	1708	3.80	2	
0.034	90	18	171	105	969	1723	3.57	3	
0.034	90	18	211	140	765	1417	3.70	1	
0.051	90	18	130	109	993	1674	3.22	2	
0.051	90	18	127	111	995	1697	3.25	3	
0.068	90	18	143	119	740	1442	2.85	1	
0.068	90	18	112	93	943	1724	2.74	2	
0.085	90	18	100	73	1006	1686	2.31	3	
0.085	90	18	140	110	690	1492	2.68	1	
0.105	90	18	91	68	994	1698	2.12	3	
0.105	90	18	96	72	894	1773	2.17	2	
0.117	—	—	extrapolation point—approx.				1.70		

TABLE IV (Continued)

Salt conc. Millimols per Liter	Z (min.)	E (volt)	w <sub>1</sub> (mm.)	w <sub>2</sub> (mm.)	h <sub>1</sub> (mm.)	h <sub>2</sub> (mm.)	u (μ)	Cell No.
Sol + 1/5 vol. Water + Strychnine Nitrate								
0.0139	90	18	214	103	946	1746	3.93	3
0.0139	90	18	274	114	716	1466	3.74	1
0.0278	90	18	210	112	967	1700	4.05	2
0.0278	90	18	208	118	965	1727	4.17	3
0.0417	90	18	191	124	774	1408	3.31	1
0.0417	90	18	152	106	960	1707	3.36	2
0.0556	90	18	117	101	996	1696	2.96	3
0.0556	90	18	162	120	767	1415	3.02	1
0.0695	90	18	96	86	995	1672	2.46	2
0.0695	90	18	96	90	988	1704	2.56	3
0.0833	90	18	110	97	732	1450	2.28	1
0.0833	90	18	81	77	1031	1636	2.16	2
0.0980	—	—	extrapolation point—approx.				1.75	

## Sol + 1/5 vol. Water + Barium Chloride

0.093	90	18	129	92	679	1503	2.33	1
0.093	90	18	102	79	961	1706	2.39	2
0.186	90	18	81	64	960	1732	1.94	3
0.186	90	18	107	75	762	1420	1.93	1
0.279	90	18	71	61	960	1707	1.77	2
0.279	90	18	71	62	988	1704	1.81	3
0.372	90	18	69	75	793	1389	1.64	1
0.372	90	18	60	60	1072	1595	1.65	2
0.465	90	18	44	73	1073	1619	1.69	3
0.600	—	—	extrapolation point—approx.				1.65	

## Sol + 1/5 Water + Aluminum Chloride

0.0075	90	18	243	124	733	1449	3.67	1
0.0075	90	18	189	98	881	1786	3.52	2
0.0150	90	18	122	95	933	1734	2.87	2
0.0150	90	18	117	112	979	1713	3.15	3
0.0225	90	18	161	55	964	1728	2.57	3
0.0225	90	18	171	80	741	1441	2.49	1
0.0300	90	18	124	77	744	1438	2.09	1
0.0300	90	18	106	65	970	1697	2.19	2
0.0375	90	18	75	52	967	1725	1.67	3
0.0375	90	18	89	73	766	1416	1.66	1
0.0420	—	—	extrapolation point—approx.				1.55	

TABLE IV (Continued)

Salt Conc. Millimols per Liter	Z (min.)	E (volt)	w <sub>1</sub> (mm.)	w <sub>2</sub> (mm.)	h <sub>1</sub> (mm.)	h <sub>2</sub> (mm.)	u (μ)	Cell No.
Sol + 1/5 Vol. Water + Potassium Chloride								
2.0	84	18	100	116	940	1727	3.25	2
2.0	84	18	105	116	1022	1670	3.32	3
4.0	60	18	66	81	992	1675	3.11	2
4.0	60	18	62	83	1002	1690	3.12	3
10.0	92	18	118	136	948	1719	3.48	2
10.0	92	18	117	141	1036	1656	3.57	3
30.0	90	15	108	117	937	1730	3.75	2
30.0	90	15	104	122	1040	1652	3.82	3
55.0	102	12	104	129	618	1564	3.62	1
55.0	102	12	86	100	983	1684	3.44	2
60.0	—	—	extrapolation point—approx.				3.40	

TABLE V

Salt Conc. Millimols per Liter	Z (min.)	E (volt)	w <sub>1</sub> (mm.)	w <sub>2</sub> (mm.)	$u = \frac{\frac{1}{2}(w_1 + w_2)H}{Z \quad E}$		Cell No.	
					H (mm.)	u (μ)		
Gold Sol								
Sol + 1/5 vol. Water								
0.0	90	18	160	190	2182	3.93	1	
0.0	90	18	121	160	2667	3.86	2	
0.0	90	18	125	160	2692	3.94	3	
Sol + 1/5 vol. Water + Potassium Chloride								
5.0	80	15	109	138	2182	3.74	1	
5.0	80	15	80	127	2667	3.83	2	
10.0	80	15	86	120	2692	3.84	3	
15.0	80	15	110	141	2182	3.80	1	
20.0	80	15	100	135	2182	3.56	1	
25.0	69	15	— 10	195	2667	4.00	2	
25.0	71	15	— 30	195	2692	3.52	3	
24.0	—	—	extrapolation point—approx.				3.65	
Sol + 1/5 vol. Water + Strychnine Nitrate								
0.083	83	18	130	157	2182	3.49	1	
0.083	83	18	80	141	2667	3.29	2	
0.166	83	18	86	137	2692	3.29	3	
0.250	98	18	85	190	2182	2.83	1	
0.333	98	18	23	160	2667	2.33	2	
0.415	98	18	28	155	2692	2.19	3	
0.415	91	18	42	160	2182	2.24	1	
0.410	—	—	extrapolation point—approx.				2.15	

TABLE V (Continued)

Salt Conc. Millimols per Liter	Z (min.)	E (volt)	w <sub>1</sub> (mm.)	w <sub>2</sub> (mm.)	H' (mm.)	u (μ)	Cell No.
Sol + 1/5 vol. Water + Barium Chloride							
0.10	91	18	117	140	2182	2.63	1
0.10	91	18	84	120	2667	2.76	2
0.20	91	18	73	109	2692	2.49	3
0.30	90	18	91	125	2182	2.42	1
0.40	90	18	55	110	2667	2.26	2
0.45	90	18	34	123	2692	2.17	3
0.47	—	extrapolation point—approx.				2.15	
Sol + 1/5 vol. Water + Aluminum Chloride							
0.0005	90	18	151	190	2182	3.83	1
0.0005	90	18	120	174	2667	4.03	2
0.0010	90	18	109	161	2692	3.74	3
0.0015	60	18	101	131	2182	3.91	1
0.0020	60	18	75	117	2667	3.95	2
0.0025	60	18	65	126	2692	3.97	3
0.0028	90	18	155	180	2182	3.76	1
0.0033	90	18	103	155	2667	3.54	2
0.0038	90	18	49	154	2692	2.81	3
0.0040	84	18	35	133	2692	2.47	3
0.0043	—	extrapolation point—approx.				2.15	

The results show consistently that the cataphoretic velocity is reduced at the concentration of total precipitation by the highly adsorbed monovalent cation salts to a value which coincides with that which is general for the polyvalent cation salts at their respective coagulation concentrations. This proves that the monovalent ions act just as the polyvalent ions in their effect upon the value of the cataphoretic velocity; both reduce the charge,  $e$ , to the same value at their coagulation concentrations when adsorption of the ion of opposite charge to that of the colloid takes place to such an extent that no very large concentration of electrolyte is needed to bring about precipitation. In the cases where large concentrations of electrolyte are required to precipitate the sol, some secondary effect brings about precipitation before the charge,  $e$ , is reduced to that value exhibited with other salts.

The results on the  $As_2S_3$  sol are all very clear cut and according to expectations, with the exception of the  $BaCl_2$  curve which is almost flat for nearly one half of its distance. This same form of curve is characteristic of  $BaCl_2$  throughout the whole series of experiments. Why the value of  $u$  should be reduced almost or actually to its critical value at a concentration of  $BaCl_2$  which is much less than that needed to flocculate the sol is difficult to explain. There were indications, however, that if more time were allowed, precipitation would occur at lower and lower concentrations of  $BaCl_2$  until the cataphoretic velocity-concentration curve moved out of the critical region; this

did not occur with other salts--as mentioned before, their flocculation value after 24 hours was almost the same after 6 days.

With Selenium Sol No. 1, it is seen that aluminum acted in a very unexpected manner, namely, it caused total precipitation while the value of  $u$  was still as great as that of the original sol. The same action is shown in the case of the Au sol with the exception that a final abrupt lowering of  $u$  to the critical value was observed. The probable explanation for this lies in the fact that both of these sols contained alkali,  $(\text{NH}_2)_2\text{HOH}$  in the case of Se sol No. 1 and  $\text{Na}_2\text{CO}_3$  in the Au sol. The alkali reacted to remove the  $\text{Al}^{+++}$  ions and form  $\text{Al}(\text{OH})_3$ . In the Se sol No. 1, precipitation took place when enough  $\text{Al}(\text{OH})_3$ , a positively charged colloid, had been formed to neutralize the Se sol; the precipitated sol had an entirely different color than that exhibited by the precipitate caused by other salts and was more fluffy in appearance. In the Au sol the amount of alkali was very small and when this had been neutralized by the  $\text{Al}_2\text{Cl}_3$  added, there was yet not enough  $\text{Al}(\text{OH})_3$  to precipitate the gold sol. A very small amount of  $\text{Al}^{+++}$  ions in excess was sufficient to precipitate the sol. The color change in the gold sol occurred at the concentration where the break in the curve occurred (0.0026 millimols of  $\text{AlCl}_3$ ). When the original electrolyte had been removed from the Se sol No. 1 to make the Se sol No. 2, it is seen that the  $\text{AlCl}_3$  curve became normal. With both of the Se sols the results are more erratic than with the other sols. This is possibly due to the fact that the particle size for these sols was so great that Brownian movement was barely able to support the particles against the force of gravity. With the Ag sol the original charge was really not great enough to allow for conclusive results to be obtained with it. The graphs for the two Se sols and for the Ag sol are shown because they, in all cases, agree with those obtained with the  $\text{As}_2\text{S}_3$  and Au sols and therefore, while not in themselves of as great significance, serve to emphasize the general nature of the results obtained with these sols as given herein both in graphic and tabular form.

#### Discussion and Theory

The equation for calculating the  $\zeta$ -potential from the migration velocity is

$$\zeta = \frac{4\pi u \eta}{\epsilon H} \quad \text{or} \quad u = \frac{\zeta \epsilon E}{4\pi \eta}$$

where  $\eta$  = viscosity,  
 $E$  = P.D. drop per unit length,  
 $\epsilon$  = dielectric constant,  
 and  $u$  = velocity.

In the derivation of this equation<sup>11</sup> the two sheets of the double layer are considered as the two sheets of a condenser and  $\zeta$ , the potential across these layers, is defined as

$$\zeta = \frac{4\pi \delta e}{\epsilon}$$

where  $e$  = charge per unit area on surface of particle,  
 and  $\delta$  = distance apart of double layers.

<sup>11</sup> Helmholtz: Wied. Ann., 7, 337 (1879).

Substituting this value into the above equation it is seen that  $u$  is independent of  $\zeta$  and of  $\epsilon$  and is only a function of  $e$ ,  $\delta$ ,  $\eta$  and  $E$ , i.e.,

$$u = \frac{\delta E e}{\eta}$$

The value of  $E$  may be determined in all cases; that of  $\eta$ , the viscosity, can be assumed not to change markedly with addition of salts in low concentrations; the value of  $\delta$ , the distance between the layers, may be a variable and has been, indeed, considered by some<sup>12</sup> to be the real variable in this phenomenon instead of  $e$ , the charge density on the surface of the particle. It is seen from the above equation that change in either of these two values would have like effects on the value of  $u$ , that is, if  $\delta$  were assumed constant and  $e$  were decreased by added salt,  $u$  would be decreased; so would it if  $e$  remained constant and  $\delta$  decreased with increased salt concentrations. There are several objections to the assumption of a constant value for  $e$  and a varying value for  $\delta$ . A variation in  $\delta$ ,  $e$  being constant, could not account for the rise in value of  $u$  for a negatively charged colloid upon addition of small concentrations of monovalent alkali cation salts and hydroxides, nor does it explain how the  $\text{Th}^{++++}$  ion can bring about an increase in  $u$ , with increased concentration, on the positively charged colloid. The assumption of a variable  $\delta$  will, as Müller concludes, explain a *decrease* in  $u$  but *not* an *increase*. By changes in  $e$ , either increases or decreases in the value of  $u$  can be pictured by assuming the greater adsorption of either the  $+$  or  $-$  ions. If we may consider  $\delta$  as constant, it is evident that  $u$  varies only and in like amount as  $e$  varies. The values given in the tables for  $u$  may be taken, then, to be direct functions of the charge on the surface of the particle.

The manner in which the electric charge functions as a stabilizing factor may be pictured somewhat as follows. The so-called "stable" lyophobic sol must be considered as only relatively stable; with such a sol, the rate at which coagulation is taking place is so low as to be unnoticed. However, after a sufficiently long time every such sol will have spontaneously coagulated. We must consider as the driving force which causes this reaction (coagulation) to take place, the interfacial tension existing between the sol particle and the surrounding medium. In the case of lyophilic sols the material difference between particle and medium is so small, due to hydration (in the case of a water medium), that interfacial tension is reduced to a minimum or is entirely absent. In such cases an electric charge on the particle is not needed to stabilize the sol—there is no tendency toward coagulation to be stabilized against. A small electric charge imparted to the particles of such a colloid bring about the opposite process to coagulation, i.e., peptization. It is a well known fact that lyophilic colloids require a relatively low energy input to bring about their peptization. For lyophobic colloids, however, this interfacial tension,  $\sigma_1$ , must always be very high, possibly of the order

<sup>12</sup> Müller: *Kolloidchem. Beihefte*, 26, 257 (1928); Gouy: *Ann. Chim. Phys.*, (9) 6, 5 (1916); 7, 129, 149 (1917).

of 1500 or more<sup>13</sup> dynes per sq. cm. of surface. The product of this tension and the difference in surface exposed to the medium before and after coagulation,  $S_b - S_a$ , will give an expression of the interfacial work,  $W_1$ .

$$W_1 = \sigma_i (S_b - S_a).$$

In a stable sol there is no thermodynamic equilibrium between two oppositely acting energy factors. The coagulation rate of a sol may best be likened to the reaction rate of some system such as  $2 H_2 + O_2$  at room temperature. If the proper catalyst is supplied the reaction goes quickly and almost completely to the coagulated form in the first case and to  $H_2O$  in the other, but in the absence of such a catalyst each system remains stable almost indefinitely.

There is, however, for a lyophobic sol a second work factor—the stabilizing factor—which is the energy elevation over which the particles must be pushed before they can come together and is to be defined as the work required to bring two particles of the sol together so closely that the first work factor,  $W_1$ , may function, i.e., into actual contact. This must be the electrical work done when the particles are brought together and must equal the product of the repulsion force acting between the particles,  $e^2/\Delta^2\epsilon$ , and the distance through which they must be moved toward each other,  $\Delta$ .

$$W_2 = \int \frac{e^2}{\Delta^2\epsilon} .d\Delta$$

Where  $\Delta$  represents the distance apart of the centers of repulsion of the particles at the moment that they begin to move toward each other,  $e$  is the charge per unit area of the particles and  $\epsilon$  is the dielectric constant of the medium separating them.  $W_2$  must also depend to some degree upon the radius of the particle but for a given sol, the above expression would stand. Any substance which has an effect upon this stabilizing factor will correspondingly influence the stability of the lyophobic sol. It has been shown that for a given sol all salts with the exception of monovalent cation salts reduce the value of  $u$ , and therefore of  $e$ , to a constant before coagulation takes place. The present work has shown that those monovalent cations which are highly adsorbed, and which bring about coagulation in low concentrations also reduce  $u$  to this same value. It is only when relatively large concentrations of salt are required to bring about precipitation that the exception occurs.

The interfacial tension work done during coagulation must greatly exceed the electrical work required to put it into operation, that is, to bring the particles together. This force resisting coagulation must be overcome, however, before the former work can be done.

The force which acts in opposition to the electrical repulsion between the particles is that arising from the kinetic energy of the particles themselves.<sup>14</sup>

<sup>13</sup> Freundlich: "Colloid and Capillary Chemistry" (1926).

<sup>14</sup> See papers by Freundlich: *Kolloid-Z.*, 23, 163 (1918); Paine and Evans: *Trans. Faraday Soc.*, 19, 649 (1924); Freundlich and Rosenthal: *Z. physik. Chem.*, 121, 463 (1926).



The average value for this, in turn, is a function of the temperature. Not every particle possesses exactly the same amount of kinetic energy that every other particle in the sol possesses at a given temperature. According to the laws of probability, by far the greater number will possess a kinetic energy content very near to that of the average, but there will be a rapidly decreasing number of particles of higher and lower kinetic energy content. The number which acquire sufficient kinetic energy in a given time to overcome the repelling force and bring about contact between the particles will depend upon the magnitude of this stabilizing factor and the temperature of the sol. In all cases, at a given temperature, the electrical work required to bring the

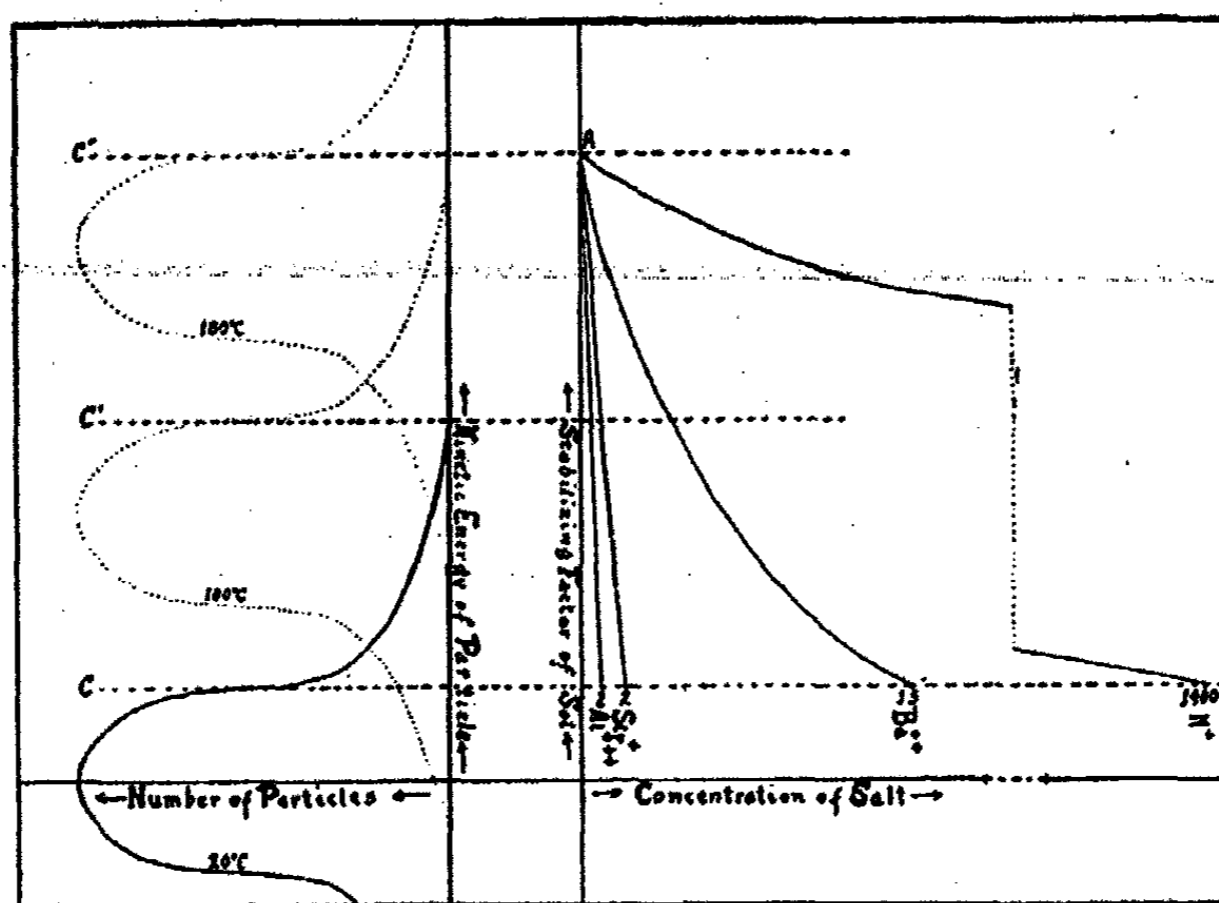

FIG. 1

Curves showing Probability Distribution of Kinetic Energy of the Particles of a Sol at a Given Temperature.

Curves showing the Influence of Salts at Various Cations upon the Stabilizing Factor (presumably  $e^2/\Delta\epsilon$ ) of an Hydrophobic Sol.

A Schematic Representation illustrating a mechanism by which the Destabilizing Effects of Salts and of Temperature on a Hydrophobic Sol may be explained.

particles together will determine the rate at which a given sol will coagulate. A schematic representation of the manner in which this influence functions is given in Fig. 1.

On the left-hand side of the perpendicular axis in Fig. 1 is drawn a theoretical curve showing the kinetic energy distribution at a given temperature (as 20°C.) of the sol particles according to the theory of probability. On the right-hand side is plotted the corresponding values for the electrical work required to bring the particles together and its change with increased concentrations of salts. At A, the charge carried by the original sol is so high

that at 20°C. only a very small number of particles possess sufficient kinetic energy to be able to perform the electrical work necessary to bring about contact upon collision before being repulsed by the electrical field acting to keep them apart. The sol is therefore stable, or rather, the rate of coagulation is so slow as to be almost unnoticeable. As the salt concentration increases, the rate of coagulation is catalysed by the reduction of  $e^2/\Delta\epsilon$ , the electrical work needed to bring the particles together, until a value,  $C$ , is reached for which the coagulation is completed after a definite short time such as 2 hours. The value of  $e$ , corresponding to this value of  $e^2/\Delta\epsilon$  is the *critical charge* at the designated temperature. A sol, the particles of which carry a charge of such magnitude that the value of  $e^2/\Delta\epsilon$  must be equal to  $A$  in Fig. 1, can be caused to coagulate in a given short period of time (as 2 hours) by (1) increasing the temperature and thereby the kinetic energy of the particles, or, at constant temperature (2) decreasing  $e$ , or (3) increasing  $\epsilon$ .

(1) Burton and Reid<sup>15</sup> have recently shown that a stable Cu sol, entirely free from any influence due to contained electrolyte, becomes unstable and coagulates in a short time if held at an elevated temperature. This is shown schematically in Fig. 1 by the dotted line showing the kinetic energy distribution of the particles according to the theory of probability at (perhaps) 180°C. Here the kinetic energy of a sufficient number of particles has been increased to such a value that the critical value ( $C''$ ) of  $e$  and therefore of  $e^2/\Delta\epsilon$  coincides with that of the original electrolyte-free sol. Burton and Reid showed that while coagulation took place quickly at 180°C., and more slowly at 150°C., below 120°C. the time required was very long and below 100°C. the sol was almost indefinitely stable. They also showed that a very small amount of added electrolyte (KCl) would reduce this critical temperature very markedly; as indicated in Fig. 1, the addition of a little electrolyte might make the sol no longer stable at 100°C., but still quite stable at room temperature. In such a case, two or even all three of the above named factors play a part in increasing the rate of coagulation of the sol.

(2) It has formerly been assumed that, at the concentration of electrolyte at which total precipitation was brought about, the amount of cation (at negatively charged surfaces) which was adsorbed was equivalent for all cations. Recently, Freundlich, Joachimsohn and Ettisch<sup>16</sup> have shown that such is not the case, but that varying amounts of anion are also adsorbed and the actual amount of cation adsorbed may vary widely. It must only exceed that of the anion by equivalent amounts to reduce the charge to any given value. In the case of all polyvalent cations and of the highly adsorbed monovalent cations it is seen that  $u$ , and therefore  $e$ , is reduced to the same definite value before total precipitation takes place, in the required time, and that this takes place in low concentrations of electrolyte. Here the amount of electrolyte adsorbed into the interface must always be comparatively small. The adsorption force for these cations is much greater than for their

<sup>15</sup> Burton and Reid: *J. Phys. Chem.*, **32**, 425 (1928).

<sup>16</sup> Freundlich, Joachimsohn and Ettisch: *Z. physik. Chem.*, (A) **141**, 249, (1929).

accompanying anions and they are adsorbed in sufficient excess to change  $e$  to the critical value in low concentrations. With such salts the change in the value  $e^2/\Delta\epsilon$  occurs so nearly entirely within the function  $e$ , that the values for  $u$  for these salts are all, within experimental error, the same.

(3) However, in the case of the salts of the alkali cations and of the acids, the amount of anion adsorbed by the colloid may even exceed that of the cation, and in such a case, large quantities of salt will be concentrated into the interface with a correspondingly small change in  $e$  (and therefore  $u$ ). Coagulation takes place while  $u$  is still much higher than in the case of the other salts. If, in this case, the value  $e^2/\Delta\epsilon$  has the same value as for the other salts at their coagulation value as seems necessary according to theory, then the decrease in  $e^2/\Delta\epsilon$  must have been brought about by an increase in  $\epsilon$ , the dielectric constant in the vicinity of the interface.

Several recent works<sup>17</sup> indicate that in exceedingly dilute solutions of KCl, for example, the value for  $\epsilon$  decreases slightly, followed by an immediate increase as the concentration of the solution increases, the minimum occurring in the neighborhood of a concentration of 4-8 millimols per liter.

Kruyt<sup>18</sup> has already postulated this change in the dielectric constant as explaining the unusual behaviour of negatively charged sols toward salts of monovalent cations of the KCl type. He has considered the potential across the double layer,  $\xi$ , as the stabilizing factor in place of  $e^2/\Delta\epsilon$  and from consideration of the equation

$$\zeta = \frac{4\pi u\eta}{E\epsilon}$$

concludes that the true value of  $\zeta$  could decrease to the critical value even while  $u$  remained higher than in the case of the polyvalent cations by a corresponding increase in  $\epsilon$ , the dielectric constant of the medium lying between the double layers, caused by the high concentration of salt in that region.

Bickerman<sup>19</sup> studied  $As_2S_3$  sols in organic mediums and came to the conclusion that in nitrobenzene and ethyl acetate,  $\zeta$  approached a constant when the values of  $\epsilon$ , the dielectric constants of the mediums, were introduced into the above equation. There was a difference of 130 per cent in the value of  $\epsilon$  for the two mediums while there was only 20 per cent difference in the calculated value for  $\zeta$ . These results may be taken to indicate that  $\zeta$  is the stabilizing factor instead of the charge,  $e$ , on the surface of the particle that is, that the factor  $u/\epsilon$  is more nearly a constant than  $u^2/\epsilon$  (the latter being directly proportional to  $e^2/\Delta\epsilon$ , the electrical work postulated above as that required to bring the particles together).

It cannot be said, therefore, that the foregoing picture of the action of electrolytes on the stability of a lyophobic sol is above criticism. It is entirely possible that some function of  $\zeta$  instead of  $e$  may be better taken as the

<sup>17</sup> Furth: *Physik. Z.*, 25, 676 (1924); Bechhold: *Ann. Physik*, 83, 427 (1927); Walden and Werner: *Z. physik. Chem.*, 129, 389 (1927); Hellman and Zohn: *Physik. Z.*, 27, 636 (1926).

<sup>18</sup> Kruyt and van der Willigen: *Z. physik. Chem.*, 130, 170 (1927).

<sup>19</sup> Bickerman: *Z. physik. Chem.*, 115, 261 (1925).

stabilizing factor. However, the mechanism of the coagulation must be of a nature similar to that pictured; just what function it is must yet remain to be determined.

The writer wishes to express his thanks and indebtedness to Professor H. R. Kruyt of the van't Hoff-Laboratory at Utrecht, Holland, for the laboratory facilities and for his personal guidance which have made the prosecution of this research possible.

## NEW BOOKS

**The Effects of Moisture on Chemical and Physical Changes.** By J. W. Smith. 22×14 cm; pp. vii + 235. London and New York: Longmans, Green and Co., 1929. Price: \$5.00. "That the presence of a certain amount of water vapour is a necessary condition for the progress of many chemical reactions is a fact which has been known for a very long time, but it is only in comparatively recent years that any systematic study has been made of the subject. These more detailed investigations, however, have been confined to a comparatively small number of reactions, and a vast unexplored field still lies before the research worker who cares to take up this subject. The more recent work has shown that the problem is by no means so simple as appeared at one time to be the case. Although the effect of moisture on some reactions may be explained readily, there are a large number of cases for which no really satisfactory explanation has yet been put forward. In still more recent times, the epoch-making discoveries of Baker, showing the enormous influence of the most minute traces of moisture on physical properties, have given a further impulse to the problem, which is at present well to the forefront amongst chemical researches.

"The relative degrees of drying to which the substances must be subjected in order to produce the effects described in the following pages differ greatly, they differ so widely, in fact, that it seems well-nigh impossible that they should all be phases of the same phenomenon. Thus it appears highly improbable that water catalyses the reaction between hydrogen and chlorine in the same manner as it does that between carbon monoxide and oxygen. Extremely rough desiccation of the latter gas mixture causes a very marked difference in the velocity of their combination, whereas very careful drying indeed is required to produce any effect in the case of a mixture of hydrogen and chlorine. Although reactions appear to fall into two or three classes in this respect, it is by no means easy to decide into which groups certain reactions should be placed. Considerable further research is required before a satisfactory classification can be made. Hence in the present state of our knowledge of this subject, it appears inadvisable to discriminate between different degrees of dryness, and the experimental data are collected here to cover as far as possible all cases where the effect of water on the progress of reactions has been investigated, excepting such cases as reaction in aqueous solution, or where water is known to play a chemical rôle in the reaction. Thus such cases as the necessity of water for bleaching by means of chlorine are not included in this discussion," p. 1.

Up to 1880 "all the observations were unrelated, and no single problem had been by any means thoroughly investigated. Each experimenter seemed to work in total ignorance of any previous work on the same system, as a glance at any of the earlier papers on the influence of moisture on the absorption of carbon dioxide by lime will reveal. Thus it cannot be said that the subject really commences until the investigations of Dixon on the union of carbon monoxide and oxygen, first published in the British Association Report for 1880. This work rapidly aroused the interest of chemists all over the world, and the importance of water vapour in promoting chemical reaction came to be generally recognised. Since that time, a considerable amount of attention has been directed at various periods to the investigation of the influence of traces of moisture on chemical reactions, especially as regards thermal and photochemical combinations, and somewhat more general theories have been evolved to account for this behaviour.

"During the present century, an entirely new aspect of the subject has been opened up through the discovery by Baker that extremely careful desiccation can exert a very pronounced effect on the physical properties of liquids and solids. The historical development of this side of the subject will be dealt with fully in a later chapter," p. 12.

The author seems to be as much puzzled as the rest of us as to what Armstrong's theory of reversed electrolysis really is. "It is not at all clear whether Armstrong considers that the water molecules are initially associated with either the carbon monoxide or the oxygen,

but one rather gathers that it is supposed not to be so. In this case the reaction must be at least termolecular, or, from Armstrong's original equation, quinquemolecular as has been pointed out by Dixon, requiring the simultaneous collision of five molecules, two of carbon monoxide, two of water and one of oxygen. The chances in favour of such a collision are very remote. Dixon pointed out that, even if it did occur, heated steam and carbon dioxide molecules would fly in all directions, some colliding and reacting with unburnt carbon monoxide molecules, i.e. carbon dioxide would be formed in a manner independent of electrical condition. Again, and this is perhaps the most serious drawback to Armstrong's hypothesis, it does not explain the oxidation of carbon monoxide in the combustion of cyanogen. Since neither nitrous oxide nor nitric oxide can replace water as a catalyst in the combustion of carbon monoxide, it cannot be supposed that oxides of nitrogen can replace water in Armstrong's depolarising circuit," p. 32.

"Hydrogen and chlorine do not combine in visible light so long as the partial pressure of water vapour present does not exceed  $10^{-7}$  mm. At  $10^{-4}$  mm. some combination occurs, and at  $10^{-3}$  mm. maximum catalysis is reached. Mixtures too dry to react at any observable rate in visible light combine readily in ultra-violet light. The wave-length producing this combination lies between 2200 and 2540 Å. A mixture has not yet been prepared which is too dry to react under these conditions. A dry mixture does not explode on heating even to temperatures much above the usual explosion point, but in the only series of experiments so far recorded, slow combination took place. Dry hydrogen chloride does not dissociate under the influence of ultra-violet light," p. 50.

"Our present knowledge of the influence of moisture on the combination of hydrogen and oxygen may be summarised as follows:—

"Pure hydrogen and oxygen can be heated to the melting-point of silver without combination after drying with phosphorus pentoxide. If only partly dried, the gases unite slowly on heating, and although visible water formed in this way may be present, no explosion occurs. The undried gases unite slowly in sunlight at ordinary temperatures, but the dried gases do not. Gases dried to such an extent that they will not combine in visible light may still do so in ultra-violet light. If very careful desiccation is carried out, however, the reaction in ultra-violet light also ceases.

"A mixture of hydrogen and oxygen seems to combine under the influence of an electric spark even after drying very carefully. Dry platinum does not appear to catalyse the reaction between dry hydrogen and dry oxygen at room temperature, but it seems to be able to catalyse the combination at a dull red heat," p. 56.

"Very carefully dried nitric oxide and oxygen do not react at ordinary temperatures. When the gases are less perfectly dried, the velocity of combination depends on the nature of the walls of the reaction vessel. Intensively dried nitrogen peroxide does not dissociate into nitric oxide and oxygen up to  $220^{\circ}\text{C}$ ," p. 60.

"Baker found that hydrogen sulphide and sulphur dioxide can be kept unchanged even if water vapour is present in some quantity; but that, if liquid water be introduced, the separation of sulphur is immediate. It was also found that if a small tube of radium bromide were placed in such a mixture and allowed to stand for some time, the whole of the gases condensed as sulphur and water in the small tube containing the salt. Baker considered that the water vapour condensed, momentarily at any rate, in liquid drops on the ionised particles in the radium bromide tube, and in the presence of these drops the reaction between the gases is rapid and complete. He also pointed out that liquid alcohol and liquid sulphur dioxide, both with a high dielectric constant, can bring about decomposition in the mixture, whilst chloroform, of which the dielectric constant is low, is inert. Metallic aluminium and mercury were also found to be unable to effect the change.

"It was found by Klein that water in its ability to accelerate this reaction is in no way exceptional or unique, since other liquids were observed to possess the same power. The gases were dried until no combination took place on mixing and allowing the mixture to stand. A small amount of organic liquid which had been dried carefully over phosphorus pentoxide was then added. Of the liquids investigated, the following induced the reaction: ethyl, isamyl, and isobutyl alcohols (all immediately); acetone (immediately); methyl

ethyl ketone (in less than two minutes); acetonitrile (in fifteen minutes); propionitrile (in seven minutes); valeronitrile (in fifteen minutes); benzyl cyanide (in two minutes); methyl benzoate (in twenty-five minutes); propyl acetate (immediately); isobutyl acetate (six minutes); ether (less than two minutes); benzaldehyde (immediately); and carvone (immediately).

"On the other hand, the following liquids produced no action: carbon disulphide, ethyl disulphide, benzene, amylene, chloroform, carbon tetrachloride, ethyl chloride, acetyl chloride, benzoyl chloride, and nitro-benzene. Klein concluded that there is no rigorous parallelism between the dielectric constant or the association of the liquid on the one hand and its ability to induce action on the other, but that the only rational explanation lay in the view that chemical reaction occurs through the formation of intermediate compounds," p. 80.

The author says, p. 112, that "another curious observation, made by Baker, is that chlorine attacks platinum in light, but not in darkness." Unfortunately he does not explain why it is curious. One would expect that chlorine would be more active in light than in darkness, though one could not have said how much more active.

"The reactions between several metals and iodine, with the latter dissolved in various dry solvents, were investigated by Parsons. A close parallelism was found to exist between the ability of a liquid to bring about the reaction between a metal and iodine, and the solubility of the metallic iodide in the liquid. It was concluded that the only logical explanation of the function of the water and other solvents which produce the reaction is that it removes the film of solid iodide from the surface of the metals and allows more iodine to come into contact with the metallic surface," p. 121.

"It has been shown spectrographically by R. W. Wood that hydrogen atoms cannot survive in a glass tube through which an electric discharge is passed if the walls are quite dry. This fact he explained by supposing that the hydrogen atoms recombine on the surface of the dry glass, whereas the presence of moisture protects them from this action.

"It was observed by Otto that a number of organic substances such as benzenesulphonic chloride, phenylic disulphide, phenylic bisulphide, *p*-toluene sulphonic chloride, and benzene sulphonic acid, whilst readily reduced by nascent hydrogen in the presence of water, were not reduced when the water was excluded," p. 137.

"The vapour of the very dry nitrogen trioxide was red, and on cooling to 10°C. condensed to the green liquid which on further cooling turned bright blue, showing that it was still nitrogen trioxide. On allowing some nitrogen, dried by passage through a long column of phosphorus pentoxide, to enter the tube, the amount of moisture it contained caused rapid dissociation, and the resulting sudden increase of pressure blew the stopper out of the tube.

"This abnormal boiling-point [of 42.5° instead of -2°] was explained on the grounds of a difference of complexity in the liquid. They supposed that a liquid consisting of more complex molecules would have a higher boiling-point than one of simple constitution, and that the almost complete absence of moisture would enable the liquid to boil as such. They considered it probable that a more complex molecule exists in the liquid below -2°C., since at this temperature a marked change in colour occurs from olive-green to bright blue. A very dry specimen in the possession of Baker, which has been drying since 1907 gradually acquired a blue colour at ordinary temperatures during the earlier years of drying, and has remained blue ever since," p. 180.

On p. 208 the author discusses the behavior of pure and dry phosphorus pentoxide "Melting began at 563°C. when the vapour pressure was 0.59 atmospheres, but the final melting-point was not observed. According to the old theory, it would be expected that the stable modification would melt at a higher vapour pressure than any shown by the metastable form, since the liquidous curve is supposed to have increasing values of the vapour pressure as the temperature rises. Actually, however, the vapour pressure at the initial melting-point was much lower in this case. These facts were explained on Smits' theory of allotropy."

It is not true that the stable form always has the higher melting-point. When there are two forms in equilibrium in the melt and when equilibrium is reached moderately slowly, the stable form may have the higher or the lower melting-point. This matter was cleared up long before the days of Smits.

"When liquids are sealed in bulbs with insoluble solid catalysts, remarkable changes gradually occur in the physical properties of the liquids. These changes have been recorded in the cases of vapour pressure, surface tension, and density. They are attributed to changes in the molecular complexities of the liquids concerned, consequent on a shift in the inner equilibrium between the larger and simpler molecules. This shift occurs very slowly, and in some cases at first even in a contrary direction to that shown in the final state," p. 217.

As may be guessed from these quotations, the author is unable to offer any theoretical explanation whatsoever. One cannot blame him for that, because nobody has any theory to offer. The value of the book lies, therefore, in the fact of its being a good compilation, and it is that. If enough people will only read it critically, somebody will eventually have an idea and things will fall into line. There does not seem to be much chance of that just now.

*Wilder D. Bancroft*

**The Kinetics of Chemical Change in Gaseous Systems.** By C. N. Hinshelwood. Second Edition. 23 × 16 cm. pp. 266. London: Oxford University Press. 1929. Price: 12 shillings, 6 pence. This second edition of Mr. Hinshelwood's well-known book has been largely rewritten so that it appears almost as a new work. It must be said at once that for any one interested in the subject it is a pleasure to read this volume. It is so well written that it is not far beyond the truth to say that it reads like a novel.

To give an idea of the plan of the book the headings of the chapters are given below:

1. Introduction. 2. Bimolecular Reactions. 3. The Energy of Activation. 4. Termolecular Reactions. 5. Unimolecular Reactions. 6. Chain-reactions. 7. The Kinetics of Heterogeneous Reactions. 8. Activation in Heterogeneous Reactions. Indexes of Subjects and Authors.

The introduction gives an elementary account of the kinetic theory of gases, including the necessary integrals and to a certain extent their derivation. The mathematics of this chapter is necessary for the understanding of the main line of thought throughout the book and can be read by any chemist with an average training in calculus.

The order of the subsequent chapters might perhaps seem a little strange as the unimolecular reactions are treated last. But the reviewer knows from personal experience that the course followed is the most natural one when it is wanted to give a consistent account of kinetics.

In the chapter on bimolecular reactions the author starts from the simplest case, the formation and dissociation of hydrogen iodide, showing the well known connection between collision number, heat of activation and reaction velocity. He next proceeds to more complicated cases including, amongst others, the hydrogen-bromine reaction, which is a very illustrative example in kinetics if not the best one, and might for that reason have been put before the more complicated decompositions, e.g. those of  $O_3$  and  $Cl_2O$ .

The errors in the determination of the constants in the equation for the reaction velocity are discussed verbally. It might have been useful for the reader if the author had given also the mathematical expression of these errors as functions of the errors, in the original measurements.

Chapter 3 gives an exposition of the concepts "process of activation" and "energy of activation." Perhaps a little more attention ought to have been paid to the work of Marcellin and certainly Scheffer's work ought at least to have been mentioned.

In Chapter 4 the current theory of termolecular reactions, especially the explanation of the negative temperature coefficient, is given. I must confess that I do not quite agree with



the author's explanation of the decreasing velocity. So far as I can see, to get a decrease in the number of ternary collisions with rising temperature, we must assume some sort of attraction between the colliding molecules.

Chapter 5 gives an account of the work in this field which we so largely owe to the author. Both the success the theory has had and the difficulties still to be surmounted are given due attention.

Chapter 6 has for very human reasons been read by the reviewer with special interest. It gives a very useful introduction to the elementary theory of chain reactions and its recent advances by Semenov, the Bodenstein school, and last but not least by the author itself.

Finally in the last two chapters heterogeneous reactions are dealt with. This very important branch of Kinetics which is still in some respects rather obscure is treated so that the main facts and theories are given. The reader will then be able to modify and apply the theories to other cases than those actually mentioned. In these chapters as throughout the book the author is very cautious not to suggest "a uniformity and simplicity which the subject does not at the moment possess" (Preface). In one place he has in the opinion of the reviewer been too cautious; the Nernst theory of the  $H_2-Cl_2$  reaction is able to explain in a natural way so many of the facts known about this reaction when due regard is taken of the influence of the walls that it might safely be given as a beautiful analogue to the well established  $H_2-Br_2$  reaction.

Although as indicated above I do not always agree with the author's views, I cannot conclude this review without once more recommending the book most heartily. It simply must be owned by or at least made accessible to every worker in Kinetics. The remarks I have made must be taken as evidence of the keen interest I have taken in the book and as suggestions for editions to come.

J. A. Christiansen

**Introduction to Statistical Mechanics for Students of Physics and Physical Chemistry.**  
By James Rice. 22 X 15 cm. pp. x + 333. London. Constable and Company, Limited. 1930. Price: 18 shillings. Statistical mechanics presents a difficult problem to the average physical chemist. As a general rule, it has not formed part of his systematic training at the University and afterwards the rapidity of growth of his subject with its great diversity of interests has limited his time for the acquirement of systematic knowledge. His knowledge of statistical mechanics has been acquired haphazard from numerous sources, and is very rarely a practical weapon to his hand. To such a physical chemist the present volume will prove of very great value. Even if he is not able to afford the time for the severe discipline which a thorough study of statistical mechanics entails, he will find that the book of Professor Rice will be of great value in informing him as to the nature of the assistance that statistical mechanics can offer towards the solutions of his special problems.

Professor Rice has, however, written his book mainly for students of chemistry and physics who are able to use it as a text-book for a systematic course of reading. A student who has studied the calculus and applied mathematics for two years at the University will find little difficulty in following the argument, and those whose knowledge of mathematics is somewhat less will be able to make headway in their study of the statistical method. On this account, it will be much appreciated by teachers of chemistry who introduce their students to certain aspects of statistical mechanics.

In the first third of the book, the author deals with classical statistical mechanics. In this section he develops the theory of the statistical method and applies it to simple molecular systems and to the equipartition of energy. There are special chapters on the statistical basis of the laws of thermodynamics, on chemical equilibrium, on intermolecular forces, and on the solid state. The subject is then brought into line with the quantum hypothesis and the classical quantum theory applied. The modifications introduced by the quantum hypothesis into statistical theory, in particular with reference to the distribution of energy in molecular systems, are fully discussed. The bearing of these results on the specific heats of gases and solids and on the Nernst heat theorem is given in chapters XVII

to XXII. Up to this stage, the author avoids the necessity for a knowledge of Hamilton's equations on the part of the student. These are now introduced in two chapters on ensembles of systems.

The author has relegated difficult proofs to appendices at the end of the chapters, with the idea that when the student has mastered the general treatment, he will feel more inclined to apply himself to its theoretical basis. Two further appendices are given at the end of the book, the first on recent developments which have arisen out of the Bose and Fermi-Dirac statistics, and the second on collision formulae and chemical kinetics. The latter is of particular interest to chemists. The chemist is, however, never satisfied, and it is hoped that the author in the next edition will extend this chapter so as to include a discussion of an application of the statistical method to the chain mechanism of Christiansen and Kramers.

This volume, which is the result of the expenditure of a great deal of labour on methods of presentation, and which has involved original work on the part of the author, will undoubtedly find a place on the bookshelves of physical chemists. Also, since its mode of presentation is so clear and logical, it will be invaluable in the training of students of chemistry, and perhaps will play an important part in the production of the super physical chemist who is needed to apply the recent developments of the wave mechanics to chemistry.

W. E. Garner

*Gmelins Handbuch der anorganischen Chemie. Edited by R. J. Meyer. System-number 19. Bismuth. Eighth edition. 26 × 18 cm; pp. xxiii + 229. Berlin: Verlag Chemie, 1927. Price: 33 marks.* As the title implies, this number is devoted to bismuth. The atomic weight is taken to be 209.0, which is the value found by Hönigschmidt and Birkensbach, p. 25. Liquid bismuth at the boiling-point follows Trouton's law and is consequently assumed to be 244.5, the same as the bismuth vapor. Bismuth is apparently monatomic when dissolved in mercury or cadmium, and diatomic when dissolved in lead, p. 26.

Bismuth is colloidal hydrous bismuth oxide stabilized by a mixture of sodium protalbinat and lysalbinat, p. 29. When a solution of bismuth nitrate in glycerine and caustic soda is reduced by formaldehyde without any addition of protecting colloid, the sol is steel-blue by transmitted light but breaks down inside of fifteen minutes, p. 30. A bismuth mirror about 90  $m\mu$  in thickness lets through about 0.1% red light and 10% of wavelength 4 $\mu$ , p. 50. "In caustic alkali of different concentrations a bismuth anode dissolves trivalent. With a concentration of about one gram bismuth per liter the anode becomes passive and coats with higher oxides of bismuth, which are at first blue-black and then gray-green when caustic soda is used. In a caustic potash solution the film is first green and then reddish-brown. In 14N KOH the film is scarlet red," p. 80.

Melted bismuth forms two liquid layers with aluminum, chromium, manganese, and cobalt; but is miscible in all proportions with nickel, mercury, thallium, zinc, lead, copper, silver, and the platinum metals," p. 83. Freshly reduced and finely divided bismuth catalyzes the formation of ammonia from nitric oxide and hydrogen; but bismuth cuts down the hydrogen activation by platinum. Bismuth catalyzes the reaction between nitrobenzene and hydrogen, the reduction products being azoxybenzene, azobenzene, hydrazobenzene, and aniline, p. 85.

Paneth's work with radio-active bismuth made it possible to prepare bismuth hydride, in appreciable amounts. It is a fairly stable gas at room temperature but very sensitive to rise of temperature. When passed through heated tubes, 35% remained undecomposed at 160°, 9% at 250°, and 6-7% at 350°. By extrapolation the boiling-point was estimated to be 295° abs., p. 105.

"Bismuthic acid,  $H_2Bi_2O_4$ , changes, when heated to 200°, into a brick-red substance, which turns golden-yellow when cooled. If allowed to stand in the sunlight for several days, it changes into the ordinary bright yellow oxide which shows no sign of turning red when heated to 300°," p. 110. It is possible to prepare an impure bismuth peroxide with a composition between  $Bi_4O_4$  and  $Bi_5O_7$ , which is peptized to an amethyst-colored colloid solution by a little 10N  $H_2SO_4$ , p. 119.

Paper soaked in a bismuth chloride solution turns brown when exposed to light but becomes colorless again in the dark, p. 141. The basic chloride is also light-sensitive, p. 147. Bismuth bromide is also sensitive to light, p. 152. When melted, bismuth bromide turns red according to Guthrie and yellow according to Jaeger. Hydrated bismuth oxalate with one of water varies in color from pink to brick red, depending on the conditions of the experiment, p. 182.

There are four radio-active isotopes of bismuth. Two are decomposition products of radium, and one each comes from thorium and from actinium, p. 203. Hahn found that ThC, formerly called Thorium B, has two groups of  $\alpha$ -rays, one with a penetration of 5 cm and the other of 8.6 cm, p. 216.

*Wilder D. Bancroft*

*Gmelins Handbuch der anorganischen Chemie. Edited by R. J. Meyer. System-number 20. Lithium. Eighth edition. 28 × 18 cm; pp. xxiv + 254. Berlin: Verlag Chemie, 1927. Price: 37.50 marks.* This number deals with lithium; its occurrence and extraction from ores; the physical and chemical properties of the metal; the compounds of lithium. There are special chapters on the compounds of lithium with hydrogen, oxygen, nitrogen, fluorine, chlorine, bromine, iodine, sulphur, selenium, boron, carbon, silicon, phosphorus, arsenic, antimony, and bismuth.

In the granite pegmatites of Southern California, lithium is found in relatively small amounts, whereas it is almost completely absent from the corresponding formations of Southern Norway, p. 2. "Metallic lithium shows no change when left lying for a long time in absolutely dry air. The metal can even be melted in dry air and cast, without losing its brilliant surface," p. 58.

The different observations on the hydration of lithium ion give values of 158, < 120, 112, 24, 21, 19, 11, and 3, pp. 61, 104, 146, which almost looks as though the error of observation is large. The electrolysis of lithium hydride, in which the hydrogen goes to the anode, gave an efficiency of 99.5% for Faraday's law, p. 75. When lithium hydride is exposed to ultra-violet light, the colorless crystals become blue, much as sodium chloride does, p. 75.

Osmotic pressures of lithium chloride in ethyl alcohol with animal bladder or gutta serena gave values one-tenth to one-fifth of the theoretical ones, p. 152. Molecular weight determination by the boiling-point indicated association for lithium chloride in amyl alcohol, p. 156. Similar experiments gave low values for lithium bromide in ethyl alcohol and high values in isobutyl alcohol and isoamyl alcohol, p. 182.

The ratio of the solubilities of lithium chloride in water and in alcohol is 11.36 at 30°, while the distribution ratios vary from 93.4 to 216.7. It is assumed that a hydrate is formed which is not readily shaken out of water, p. 156. The addition of cane sugar lowers the boiling-point of concentrated lithium chloride solutions, which is considered to indicate a breaking-down of some hydrate, p. 160. No statement is made as to whether lithium chloride is soluble in melted sugar, though that might be the real explanation of the matter.

Apparently no solid polyiodide is formed when potassium iodide is added to a saturated solution of iodine in benzene at 25°, p. 199. Lithium iodide can be made to crystallize with 7, 5.5, 5, 4, 3, 2, and 1 of ammonia, p. 200, whereas in water only the definite hydrates, 3, 2, 1, and 0.5 water seem to be known, p. 190. Anhydrous lithium iodide appears to take up 4, 2 and 1 of sulphur dioxide.

*Wilder D. Bancroft*

*Gmelins Handbuch der anorganischen Chemie. Edited by R. J. Meyer. System-number 31. Radium and Isotopes. Eighth edition. 28 × 18 cm; pp. xviii + 80. Berlin: Verlag Chemie, 1928. Price: 15 marks.* The subject is treated under the general heads: radium; mesothorium I; Thorium X; Actinium X. The number is mostly literature references with a minimum of text. The reviewer was rather interested in the account of the uranium deposits in Russia, p. 5. They occur on the eastern slopes of the Urals in the acid

rocks of the granite type. Of course these do not cut any figure in comparison with the Katanga deposits in the Belgian Congo. Since the moon presumably has about the same composition as the earth, the radio-active minerals are supposed to occur there, p. 3. None of the strong radium lines have as yet been found in the solar spectrum, p. 4.

"Apart from the use in scientific investigations, high-grade or pure radium salts are of great importance especially in medicine for radiation purposes. They are especially characterized by the constancy of the activity as compared with the other radio-active compounds in use. The practical form for therapeutical purposes in closed containers is the very sparingly soluble sulphate. In cases in which it is desired to dissolve the salt in water (to separate the emanation, for instance), the chloride or bromide is used. . . . There is an extensive use of radium and mesothorium salts for making luminous paints (usually zinc sulphide with an admixture of radium salt). . . . It has been estimated by G. Berndt that during the war, from 1914 to 1918, twenty grams of radium element were consumed in luminous paints," p. 63.

After commercial thorium nitrate had been shown to have less than half the activity than it should have if it contained  $RdTh$  as a decomposition product, it was found first that there was an intermediate product, mesothorium; and then that mesothorium was a mixture of Mesothorium I and Mesothorium II, p. 64.

Minerals containing mesothorium are found in all parts of the world; but, the commercially important sources are the monazite sands, chiefly of Brazil and the Carolinas, p. 65.

The reviewer was interested to note that the precipitation of thorium X from alkaline solutions by metals is classed as electrochemical precipitation without the use of the electrical current, p. 73.

Actinium X is the first decomposition product of  $RdAc$  and is the source of the actinium emanation. It has a half-time life of 11.2 days, p. 77.

Wilder D. Bancroft

*Recueil des Travaux chimiques des Pays-Bas, Vol. 48, No. 9. 24 × 16cm. pp. ii + 278. Amsterdam: Soc. anon. d'éditions scientifiques D. B. Centen, 1929.* The August number of the "Recueil" is a *Festschrift* to honour the seventieth birthday of A. F. Holleman, and its cover is decorated with a photograph of the chemical laboratory of the University of Amsterdam. It contains fifty-six papers, of which thirty are from Dutch laboratories and the remainder from nine other countries. In spite of the fact that the number commemorates a Dutch celebration, the usual custom of the journal is followed and the papers are all in either English, French, or German, with the exception of two in Italian.

The range of subjects discussed is naturally wide; the majority are of organic chemical interest, as befits the occasion, and, as is yet more fitting, several deal with various aspects of the problem of substitution in the benzene nucleus. Of these latter a paper by C. K. Ingold is very valuable, since it summarises thirty-eight papers by Ingold and his co-workers and is a clear and concise statement of the views that he holds on the whole question of the causes and mechanism underlying the observed facts of substitution and migration in benzene and its derivatives.

The contents of a few other papers may be mentioned briefly. There is a useful discussion by E. Moles on the values of the atomic weights of the fundamental elements, Ag, N, Cl, Br, H, C, S, Na and K; all of these are now known with an accuracy greater than one part in 10,000 and the most probable values are given. A short paper by P. Walden on the advantages of trichloroacetic acid as a cryoscopic solvent begins with a very graceful paragraph in honour of Holleman. J. Timmermans records some remarkable results in the melting-point curves of binary mixtures of optically active compounds which seem to promise a new method of establishing the relationships in configuration in such substances; if the method proves successful, it will be possible to attack the Walden inversion from a new angle.

The *Festschrift* custom is a very good one, for it enables the feelings of esteem felt towards a great chemist to find a form of expression.

T. W. J. Taylor.

